

National Oceanography Centre, Southampton

Cruise Report No. 32

RV Sonne Cruise 198-2

18 JUN-01 AUG 2008

Merak, Indonesia - Merak, Indonesia

Principal Scientists

T J Henstock¹, S S Gulick² & H Permana³

Authors

S M Dean¹, T J Henstock¹, S S Gulick² & H Permana³ et al

2008

National Oceanography Centre, Southampton
University of Southampton, Waterfront Campus
European Way
Southampton
Hants SO14 3ZH
UK

Tel: +44 (0)23 8059 6491
Email: then@noc.soton.ac.uk

¹ NOCS, Southampton

² University of Texas Institute for Geophysics, USA

³ LIPI, Indonesia

DOCUMENT DATA SHEET

AUTHOR DEAN, S M, HENSTOCK, T J, GULICK, S S & PERMANA, H et al	PUBLICATION DATE 2008
TITLE RV <i>Sonne</i> Cruise 198-2, 18 Jun-01 Aug 2008. Merak, Indonesia - Merak, Indonesia.	
REFERENCE Southampton, UK: National Oceanography Centre, Southampton, 134pp. (National Oceanography Centre Southampton Cruise Report, No. 32)	
ABSTRACT <p>All plate boundaries are divided into segments - pieces of fault that are distinct from one another, either separated by gaps or with different orientations. The maximum size of an earthquake on a fault system is controlled by the degree to which the propagating rupture can cross the boundaries between such segments. A large earthquake may rupture a whole segment of plate boundary, but a great earthquake usually ruptures more than one segment at once.</p> <p>Earthquakes offshore of Sumatra on December 26 2004 ($M_w=9.3$) and March 28 2005 ($M_w=8.7$) ruptured, respectively, 1200-1300 km and 300-400 km of the subduction boundary between the Indian-Australian plate and the Burman and Sumatra blocks. Rupture in the 2004 event started at the southern end of the fault segment, and propagated northwards. The observation that the slip did not propagate significantly southwards in December 2004, even though the magnitude of slip was high at the southern end of the rupture strongly suggests a barrier at that place. Maximum slip in the March 2005 earthquake occurred within ~100 km of the barrier between the 2004 and 2005 ruptures, confirming both the physical importance of the barrier, and the loading of the March 2005 rupture zone by the December 2004 earthquake.</p> <p>Cruise SO198-2, from Merak to Merak between 18 June and 01 August 2008 is the second of three cruises, funded by the Natural Environment Research Council (NERC), which will form a coherent set of geophysical observations in the source regions of the 2004 and 2005 great Sumatra earthquakes. This cruise collected seismic reflection (MCS) profiles at SB1 and SB2 with the following objectives:</p> <ol style="list-style-type: none">1. To image the geometry and nature of the downgoing slab from the trench to 30-40 km depth within the forearc2. To image faults within the over-riding plate responsible for the development of the accretionary wedge3. To provide a set of shots that will calibrate the array of ocean-bottom seismometers deployed on cruise SO198-1, and be recorded by the land seismometer array established by a different part of the consortium. <p>Cruise SO198-2 also included nine days of ship time funded by the United States National Science Foundation to investigators from the University of Texas Institute for Geophysics (UTIG). This allied study targeted the subject of rupture pathways, with a focus was on how the earthquake rupture propagates updip through the accretionary prism to ultimately move the seafloor and create the tsunami.</p> <p>Approximately 5000km of multichannel seismic reflection data were collected during the cruise, as well as continuous recording of gravity, magnetics, Parasound and swath bathymetry data while in the permitted area.</p>	
ISSUING ORGANISATION National Oceanography Centre, Southampton University of Southampton, Waterfront Campus European Way Southampton SO14 3ZH UK Tel: +44(0)23 80596116Email: nol@noc.soton.ac.uk	

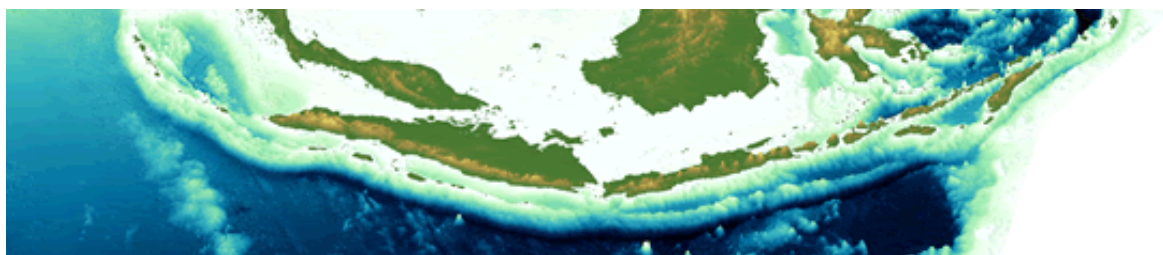

Cruise Report: SO198-2

15th June to 1st August 2008

Merak to Merak

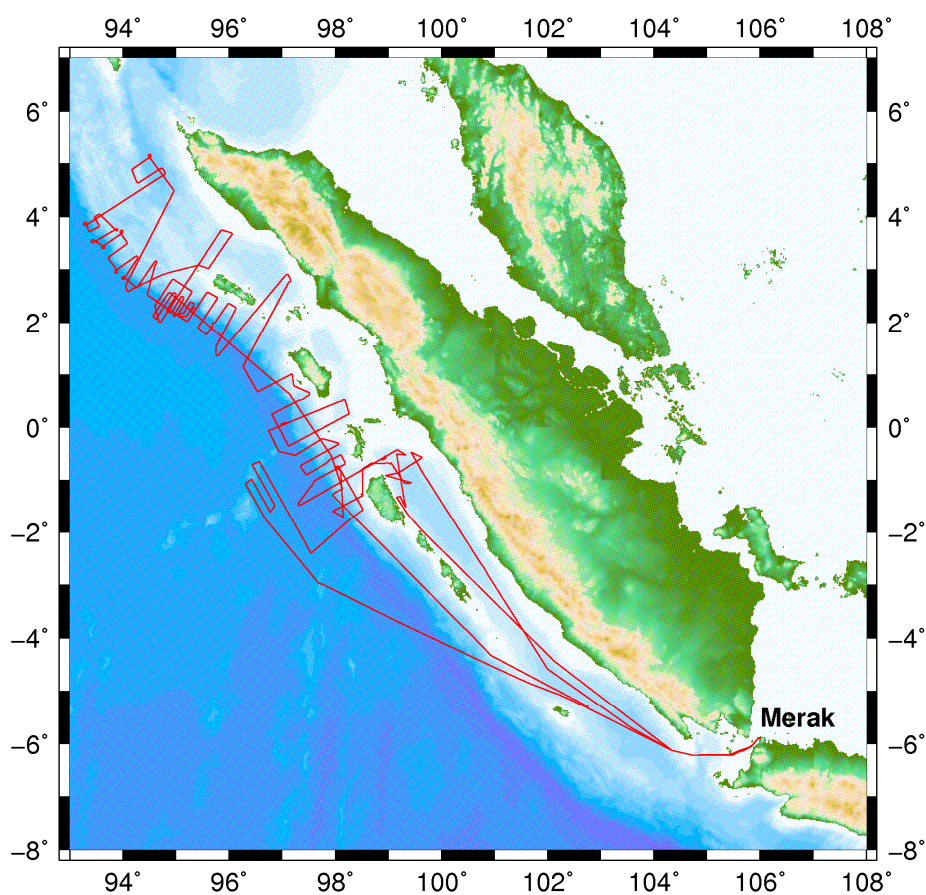

Table of Contents

Table of Contents	1
Participants.....	4
Science Party.....	4
RV Sonne	4
Contact Details.....	5
Introduction.....	6
Explanatory Notes	9
Navigation.....	9
Seismic source.....	10
Airguns	10
<i>LongShot</i> gun controller	12
Operational issues with the seismic source.....	14
Multichannel Seismic (MCS) system.....	16
Streamer.....	16
Data acquisition system	17
Ship-board MCS processing.....	19
Expendable Bathythermographs (XBTs).....	21
XBT launcher and data acquisition system	22
Operational issues with the XBT system	24
Swath bathymetry (Simrad EM120)	25
Sub-bottom profiler (Parasound).....	28
Converting <i>Parasound</i> data to SEG-Y format.....	29
Trace header values.....	30
Data processing	32
Gravity meter	33
Cigading base station tie	33
Gravity meter clock drift.....	37
Gravity data reduction	38
Magnetometer.....	39
Tow configuration	39
Data format.....	43
Layback correction	44
Operational issues with the <i>SeaSPY</i> system.....	45
Results: Prologue (15 th – 27 th June)	46
Survey narrative.....	46
Julian Day 167, Sunday 15 th June.....	46
Julian Day 168, Monday 16 th June	46
Julian Day 169, Tuesday 17 th June	47
Julian Day 170, Wednesday 18 th June	47
Julian Day 171, Thursday 19 th June	47
Julian Day 172, Friday 20 th June	48
Julian Day 173, Saturday 21 st June.....	48
Julian Day 174, Sunday 22 nd June	49
Julian Day 175, Monday 23 rd June	49
Julian Day 176, Tuesday 24 th June	49
Julian Day 177, Wednesday 25 th June	49
Julian Day 178, Wednesday 26 th June	50
Julian Day 179, Thursday 27 th June	50

Seismic source.....	50
Expendable bathythermograph data	51
Swath bathymetry	53
Parasound data.....	54
Gravity data.....	55
Magnetic data	56
Results: Survey Box 2 (28 th June – 11 th July).....	57
Survey narrative.....	57
Julian Day 180, Thursday 28 th June	57
Julian Day 181, Thursday 29 th June	57
Julian Day 182, Thursday 30 th June	57
Julian Day 183, Thursday 1 st July.....	57
Julian Day 184, Thursday 2 nd July.....	58
Julian Day 185, Thursday 3 rd July	58
Julian Day 186, Thursday 4 th July	58
Julian Day 187, Thursday 5 th July	59
Julian Day 188, Thursday 6 th July	60
Julian Day 189, Thursday 7 th July	61
Julian Day 190, Thursday 8 th July	61
Julian Day 191, Thursday 9 th July	61
Julian Day 192, Thursday 10 th July	62
Julian Day 193, Thursday 11 th July	62
Seismic source.....	63
Multichannel seismic reflection data	64
Expendable bathythermograph data	73
Swath bathymetry	74
Parasound data.....	75
Gravity data.....	76
Magnetic data	77
Results: Survey Box 1 (11 th – 17 th July).....	79
Survey narrative.....	79
Julian Day 193, Thursday 11 th July	80
Julian Day 194, Thursday 12 th July	80
Julian Day 195, Thursday 13 th July	80
Julian Day 196, Thursday 14 th July	80
Julian Day 197, Thursday 15 th July	81
Julian Day 198, Thursday 16 th July	81
Julian Day 199, Thursday 17 th July	81
Julian Day 200, Thursday 18 th July	82
Seismic source.....	82
Multichannel seismic reflection data	83
Expendable bathythermograph data	91
Swath bathymetry	93
Parasound data.....	94
Gravity data.....	95
Magnetic data	96
Results: UTIG Survey (18 th – 24 th July)	98
Survey narrative.....	98
Julian Day 200, Thursday 18 th July	99
Julian Day 201, Thursday 19 th July	99

Julian Day 202, Thursday 20 th July	99
Julian Day 203, Thursday 21 st July.....	99
Julian Day 204, Thursday 22 nd July.....	100
Julian Day 205, Thursday 23 rd July	100
Julian Day 206, Thursday 24 th July	100
Seismic source.....	101
Multichannel seismic reflection data	102
Swath bathymetry	110
Gravity data.....	111
Parasound data.....	111
Magnetic data	112
Results: High-resolution survey and strike lines (25 th – 31 st July).....	114
Survey narrative.....	114
Julian Day 207, Thursday 25 th July	114
Julian Day 208, Thursday 26 th July	115
Julian Day 209, Thursday 27 th July	115
Julian Day 210, Thursday 28 th July	116
Julian Day 211, Thursday 29 th July	116
Julian Day 212, Thursday 30 th July	116
Seismic source.....	116
Multichannel seismic reflection data	117
Expendable bathythermograph data	122
Summary of results for SO198	125
References	131
Appendix A: Cruise data.....	132
Appendix B: Julian Day Calendar	133
Appendix C: RV Sonne.....	134

Participants

Science Party

Name		Institute/affiliation	Position
Timothy John	HENSTOCK	Southampton	Co-Chief Scientist
Sean Sandifer	GULICK	UTIG	Co-Chief Scientist
Haryadi	PERMANA	LIPI	Co-Chief Scientist
James Albert	AUSTIN	UTIG	Scientist
Jonathan Mark	BULL	Southampton	Scientist
Simon Matthew	DEAN	Southampton	Scientist
Kylara Margaret	MARTIN	UTIG	Student
Lisa Clare	McNEILL	Southampton	Scientist
Stefan Gerald	PATERSON	EEL	Streamer Engineer
David Peter	ROBINSON	Oxford	Scientist
Acep	RUCHIMAT	BPPT	Scientist
P. Kartika Dani	SETIAWAN	GMU	Scientist
Marina	SITI	PPPGL	Scientist
Neil Andrew	SLOAN	Southampton	Compressor Engineer
Matthew James	SMITH	EEL	Streamer Engineer
William Kevin	SMITH	Southampton	Compressor Engineer
Klaus-Peter	STEFFEN	IFM-GEOMAR	Airgun Engineer
Nunung	SUHARTONO	TNI-AL	Security Officer
Dirk	WEHREND	IFM-GEOMAR	Airgun Engineer

RV Sonne

Lutz	MALLON	Master
Detlef	KORTE	Chief Officer
Nils Arne	ADEN	1. Officer
Heinz-Ulrich	BÜCHELE	2. Officer
Anke	WALTHER	Ship's Doctor
Rudolf	ANGERMANN	Ch. Electronic Engineer
Rainer	BEYER	Electronic Engineer
Matthias	GROSSMANN	System Manager
Wolfgang	BORCHERT	System Manager
Werner	GUZMAN-NAVARRETE	Chief Engineer
Jörg	BUß	2. Engineer
Paul-Lucas	SCHMIDTGEN	2. Engineer
Uwe	RIEPER	Electrician
Rainer	ROSEMEYER	Fitter
Volker	BLOHM	Fitter
Robert	NOACK	Motorman
Ryszard	KRAWCZAK	Motorman
Frank	TIEMANN	Chief Cook
Antony	GANAGARAJ	2. Cook
Andreas	POHL	1. Steward
Luis	ROYO	2. Steward
Andreas	SCHRAPEL	Boatswain
Werner	HÖDL	A.B.
Jürgen	KRAFT	A.B.
Ingo	FRICKE	A.B.
Henning	SCHNUR	A.B.
Joachim	DOLIEF	A.B.
Finn	MOHRDIEK	A.B.
Christian	FINCK	Trainee

Contact Details

Badan Pengkajian dan Penerapan Teknologi (BPPT)
Building 2, 19th Floor
Jl. M.H. Thamrin No. 8
Jakarta 10340
Indonesia

Department of Earth Sciences
University of Oxford
Parks Road
Oxford, OX1 3PR
United Kingdom

Forschungsschiffe
Leibniz-Institut fuer Meereswissenschaften, IFM-GEOMAR
Gebaeude Westufer
Duesternbrooker Weg 20
D-24105 KIEL
Germany

Institute for Geophysics, University of Texas (UTIG)
J.J. Pickle Research Campus, Building 196 (ROC)
10100 Burnet Road (R2200)
Austin, Texas 78757-445
USA

Jawatan Hidro Oceanografi
Tentara Nasional Indonesia – Angkatan Laut (TNI-AL)
Jl. Pantai Kuta V/1, Ancol Timur
Jakarta 14430
Indonesia

National Oceanography Centre, Southampton
European Way
Southampton, SO14 3ZH
United Kingdom

Paleontology and Stratigraphy Laboratory, Geological Department,
Engineering Faculty
Gadjah Mada University, Yogyakarta (GMU)
Jl. Grafika 2, Pogung
Yogyakarta
Indonesia

Pusat Penelitian dan Pengembangan Geologi Kelautan (PPPGL)
Marine Geological Institute
Jl. Dr. Junjuran No. 236
Bandung 40174
Indonesia

Research Center for Geotechnology - LIPI
LIPI Campus
Jl. Sangkuriang Bandung- 40135
Indonesia

Introduction

All plate boundaries are divided into segments – pieces of fault that are distinct from one another, either separated by gaps or with different orientations. The maximum size of an earthquake on a fault system is controlled by the degree to which the propagating rupture can cross the boundaries between such segments. A large earthquake may rupture a whole segment of plate boundary, but a great earthquake usually ruptures more than one segment at once.

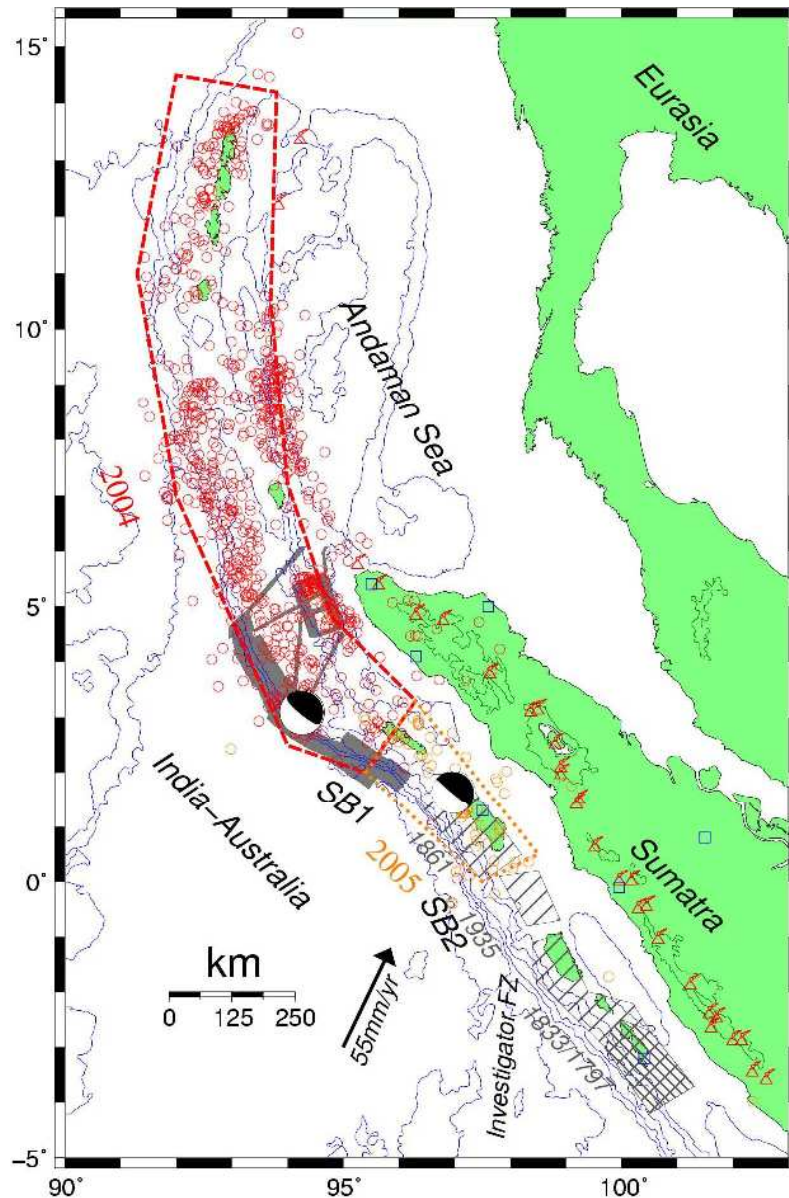

Figure 1: Regional setting of the Sumatra subduction zone. Approximate mainshock rupture extents and the first ten days of aftershocks with $M > 5$ are shown in red (26th December, 2004) and orange (28th March, 2005) respectively, with Harvard CMT solutions. Hatching – estimated extent of major previous earthquakes, cross-hatching where constrained by coral uplift. Grey shading – HMS Scott bathymetry coverage. Blue squares – location of new permanent seismic stations. Elevation contoured at 1000 m intervals. Active arc volcanoes also marked.

The December 26th 2004 M_W 9.3 earthquake and the March 28th 2005 M_W 8.7 earthquake ruptured, respectively, 1200–1300 km and 300–400 km of the subduction boundary between the Indian-Australian plate and the Burman and Sumatra blocks. Rupture in the 2004 event started at the southern end of the fault segment, and propagated northwards. The observation that the slip did not propagate significantly southwards in December 2004, even though the magnitude of slip was high at the southern end of the rupture strongly suggests a barrier at that place. Maximum slip in the March 2005 earthquake occurred within ~100 km of the barrier between the 2004 and 2005 ruptures, confirming both the physical importance of the barrier, and the loading of the March 2005 rupture zone by the December 2004 earthquake.

Cruise SO198-2, from Merak to Merak between 18th June and 30th July 2008 is the second of three cruises, funded by the Natural Environment Research Council (NERC), which will form a coherent set of geophysical observations in the source regions of the 2004 and 2005 great Sumatra earthquakes. This cruise collected seismic reflection (MCS) profiles at SB1 and SB2 with the following objectives:

1. To image the geometry and nature of the downgoing slab from the trench to 30-40 km depth within the forearc
2. To image faults within the over-riding plate responsible for the development of the accretionary wedge
3. To provide a set of shots that will calibrate the array of ocean-bottom seismometers deployed on cruise SO198-1, and be recorded by the land seismometer array established by a different part of the consortium
4. To collect a detailed grid of lines along the frontal part of the accretionary wedge to investigate whether segmentation of the surface morphology is diagnostic of segmentation of faults within the wedge and the main plate boundary

These objectives are also linked to data acquisition in cruises SO198-1 and SO200 and an ongoing earthquake recording experiment on Sumatra and some of the offshore islands. Delays in the transport of the MCS streamer meant that this crucial item was not available until 14 days after the original sailing date, which significantly impacted the scientific programme. Nevertheless, objectives 1-3 were met in full, and objective 4 in part.

Cruise SO198-2 also included nine days of ship time funded by the United States National Science Foundation to investigators from the University of Texas Institute for Geophysics (UTIG). This allied study also targeted the subject of rupture pathways only for the UTIG survey the focus was on how the earthquake rupture propagates updip through the accretionary prism to ultimately move the seafloor and create the tsunami. The planned survey was within the 2004 earthquake rupture area and thus by design is synergistic with the NERC funded efforts at the southern end of the 2004 rupture area and farther south.

Goals of the UTIG survey included:

1. Map prism structure, including the décollement near the prism toe, thrust faults and their vergence along- and across-strike, and the prism's taper, in order to understand potential rupture pathways,
2. Look for evidence of rupture and any correlation between landward-vergence and evidence for rupture near the toe, and
3. Examine portions of the Aceh (forearc) Basin and thrust-related (piggyback) basins, in concert with the SEATOS high-resolution and other available data, to determine drillable targets for examining this margin's history of great earthquakes.

Due to the delays in streamer shipping, approximately 6.5 days of acquisition was devoted to this survey. However, the high data quality and efficient use of the ship time during this time allowed collection of 25 profiles that should be sufficient to gain insight into all three goals.

Explanatory Notes

Navigation

The RV Sonne operates a number of GPS navigation receivers, including an Ashtech GG24 Glonass GPS, an Ashtech MicroZ GPS and a Trimble NT200DS. The main GPS antennas are located on the mast directly above the bridge, 28 m from the waterline (Figure 2). This antenna location is the origin for all the navigation data acquired during SO198-1.

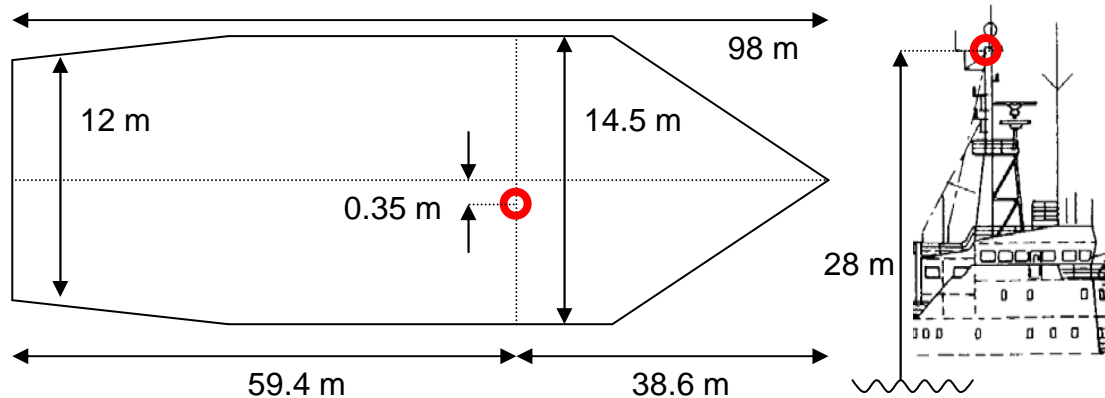

Figure 2: The location of the GPS antenna (red circle) on the mast above the bridge of the RV Sonne, 28 m from the water line.

The data from each GPS receiver are logged independently in the ship's database, but one of the GPS receivers is manually selected to be the *System GPS*, the data from which is used by all the scientific equipment onboard that can take a navigation input including the swath bathymetry system, the sub-bottom profiler and the laboratory displays (Figure 3). During SO198-1 the Ashtech GG24 Glonass GPS receiver was selected to be the *System GPS*.

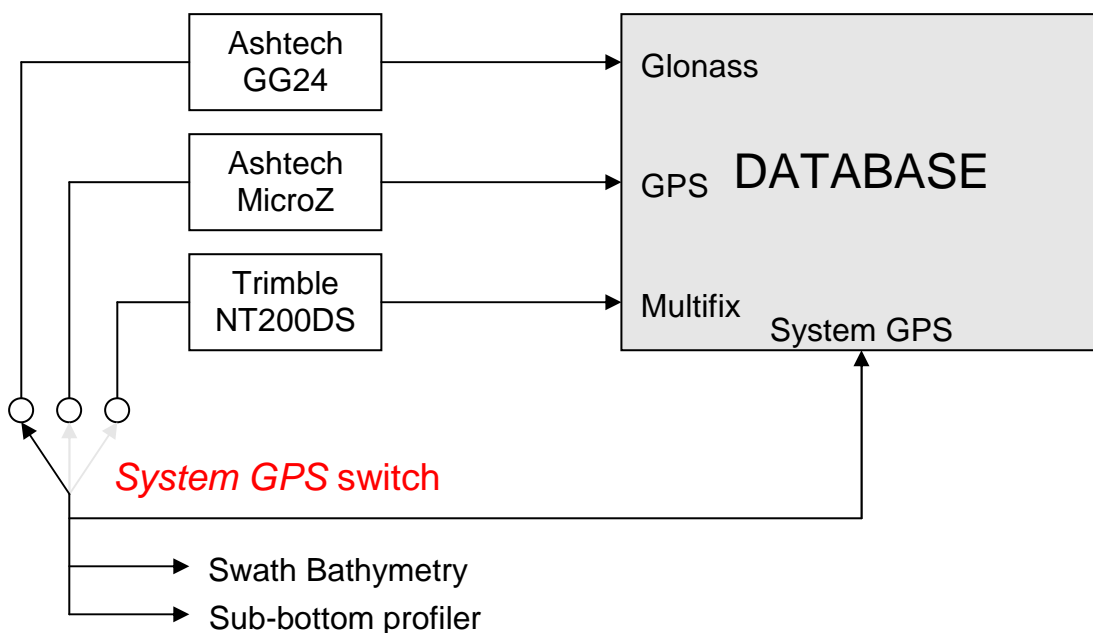

Figure 3: The relationship between the Ashtech GG24, MicroZ and Trimble GPS receivers, System GPS, and the data logged in the ship's database.

Seismic source

Airguns

The seismic source employed for SO198-2 consisted of a twelve airgun tuned array with a total capacity of 5420 cu. in. The Sonne's fixed compressors were supplemented by a containerised compressor, fixed to the afterdeck, that fed the airguns at a pressure of 150 bar (2174 psi). The airguns were SSI Soderia G-guns with capacities of 8x520 cu. in., 2x380 cu. in., and 2x250 cu. in. The airguns were clustered into pairs of like-sized guns (Figure 4).

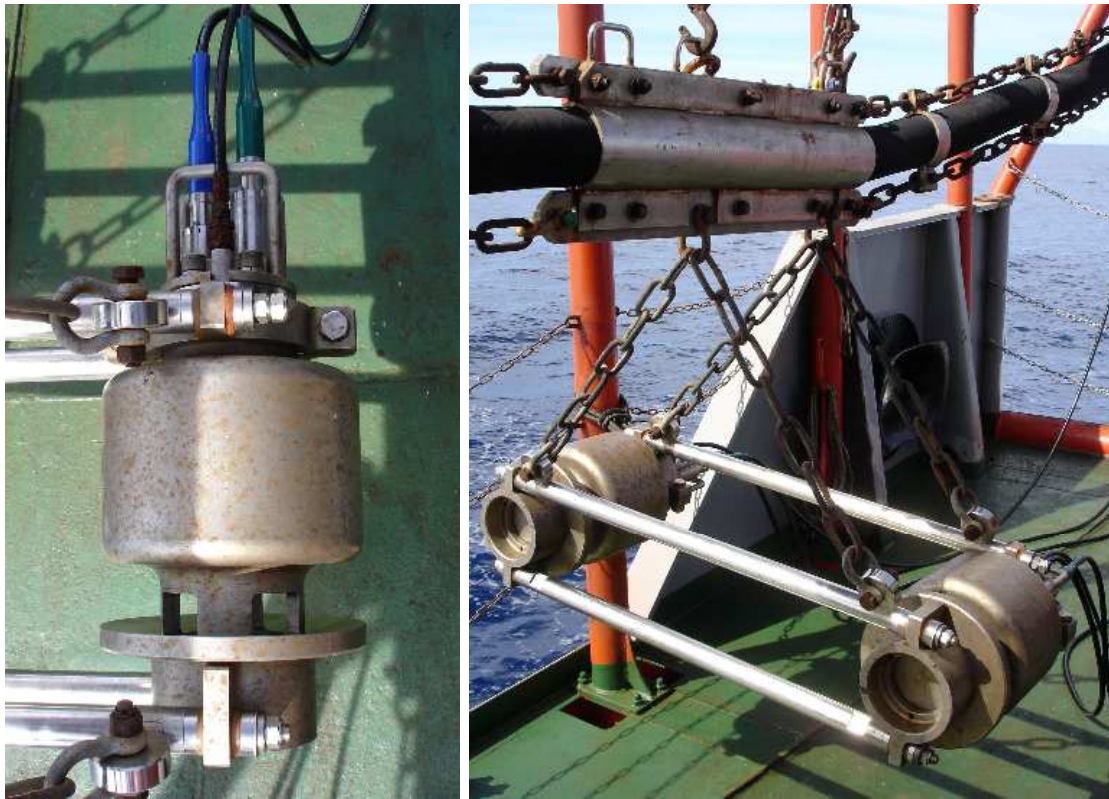

Figure 4: An Soderia G-gun (left panel) with air hose, solenoid valve and M/P time break connectors (top), chamber (middle) and ports (bottom). Airguns were clustered in pairs of like-sized guns (right panel), each suspended by chains beneath a flexible towing frame to which the floatation buoys were attached.

Two sets of three airgun-clusters were towed from the afterdeck, one set either side of the vessel; a total of eight buoys, four for each set of clusters, supported the airguns ~8 m below the sea surface. The air hoses were marked with tape after the airguns were deployed and the distance from the back of the ship to the airguns was measured after recovery with a tape measure. The dimensions measured are summarised in Figure 5.

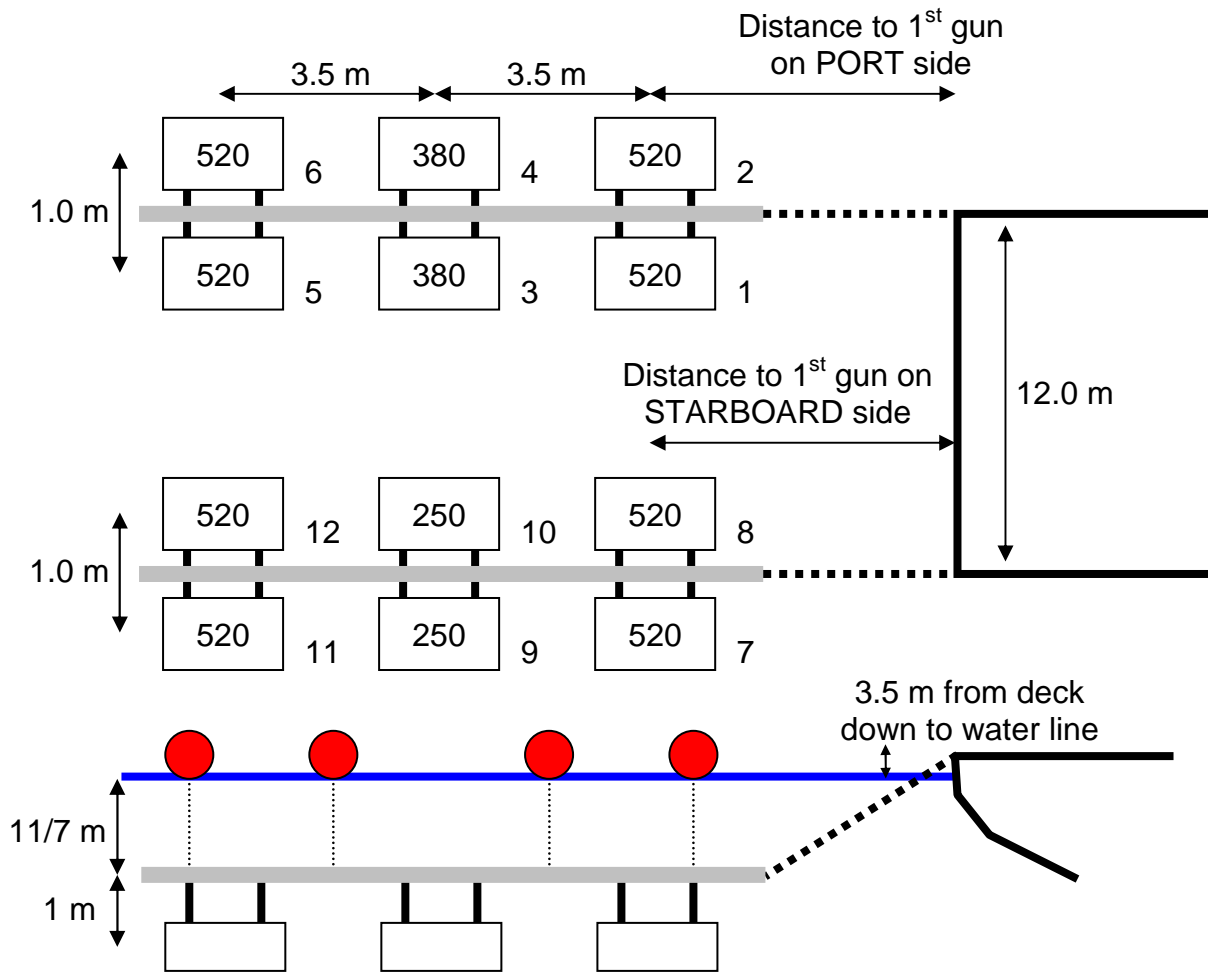

Figure 5: Schematic diagram showing the dimensions of the airgun array towed during SO198-2, and the airgun numbers, as used by the gun controller. Airgun volumes are given in cubic inches, all other dimensions are in metres. The tow depth, and therefore the distance between the back of the ship and the first airgun in the port side and starboard array varied during the cruise and are given in Table 1.

The depth at which the guns were towed varied during the cruise: 12 m depth during the prologue when the source was shooting to ocean-bottom seismometers (OBS) and seismic land stations, and 8 m for the remainder of the cruise, when the source was shooting for multichannel seismic data. The total hose length was 40.65 m on the port side and 38.9 m on the starboard side. Since the hose lengths to the airguns did not change, the distance between the centre of the array and ship changes with the towing depth. Given that the GPS antenna used for navigation is 59.4 m from the stern of the vessel (Figure 2), the variations in layback to the centre of the airgun array are summarised in Table 1.

Survey	Gun array depth (m)	Distance to 1 st gun on port side	Distance to first gun on starboard side	Distance from source centre to GPS antenna
SUMC	12	37.58	35.68	99.53
SUMD, SUME & SUMUT	8	38.99	37.16	100.98

Table 1: Distances from the back of the ship to the first gun for the port and starboard airgun arrays, and the average distance to the centre of the array from the GPS antenna.

LongShot gun controller

The airguns were fired using a Real Time Systems Controller Module, running *LongShot* V7.08,0705 software, and four *FourShot* Solenoid Power Supply modules (Figure 6). Only three of the *FourShot* modules were required for the twelve airguns. The Controller Module was triggered using a Zyfer GPStarplus model 565 clock connected to a GPS antenna located on the rail above the Geology Lab.

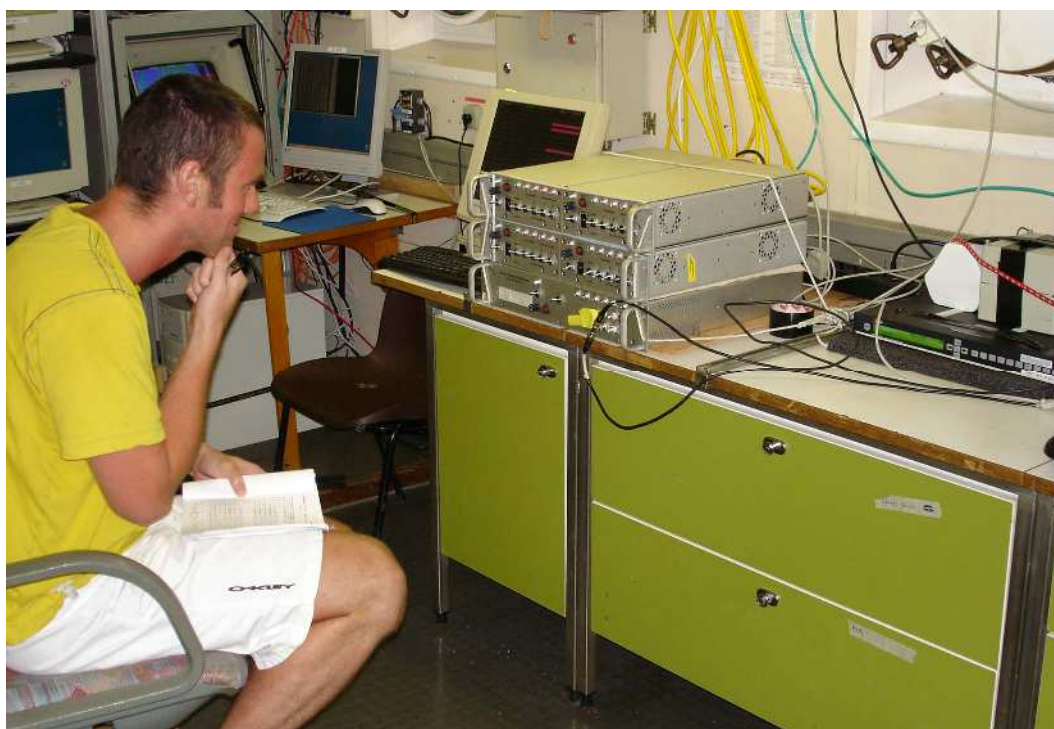

Figure 6: The airgun controller and logging system. A pulse from the Zyfer GPS clock (black box, right) triggers the Real Time Systems Controller Module (lowest of the three silver boxes, centre) that fires each airgun through the *FourShot* Solenoid Power Supply modules (two upper-most silver boxes, centre). The Controller Module optimises the firing of each airgun using *LongShot* software that is displaying on the screen (obscured, left; Figure 7). Trigger pulses from the Zyfer clock are recorded on the modified OBS logger (grey box, right). Shot times and numbers are noted by hand and logged by a PC versus GPS time.

The gun firing system synchronises all the guns in the array to fire constructively. Synchronising the gun pulses is the purpose of the *LongShot* software (Figure 7). Each gun in the array responds slightly differently, providing maximum power at a different time after it is triggered to fire.

LongShot uses data from hydrophones located adjacent to each gun to measure the signal produced every time it fires and adjust each individual gun's timing so that the peak energy from all the guns occurs at the same time. In order to allow *LongShot* to fire some guns earlier than others, a delay is set between the time the system is triggered and the time the guns are aimed to achieve peak energy. During SO198-2 this delay was set to 60 ms.

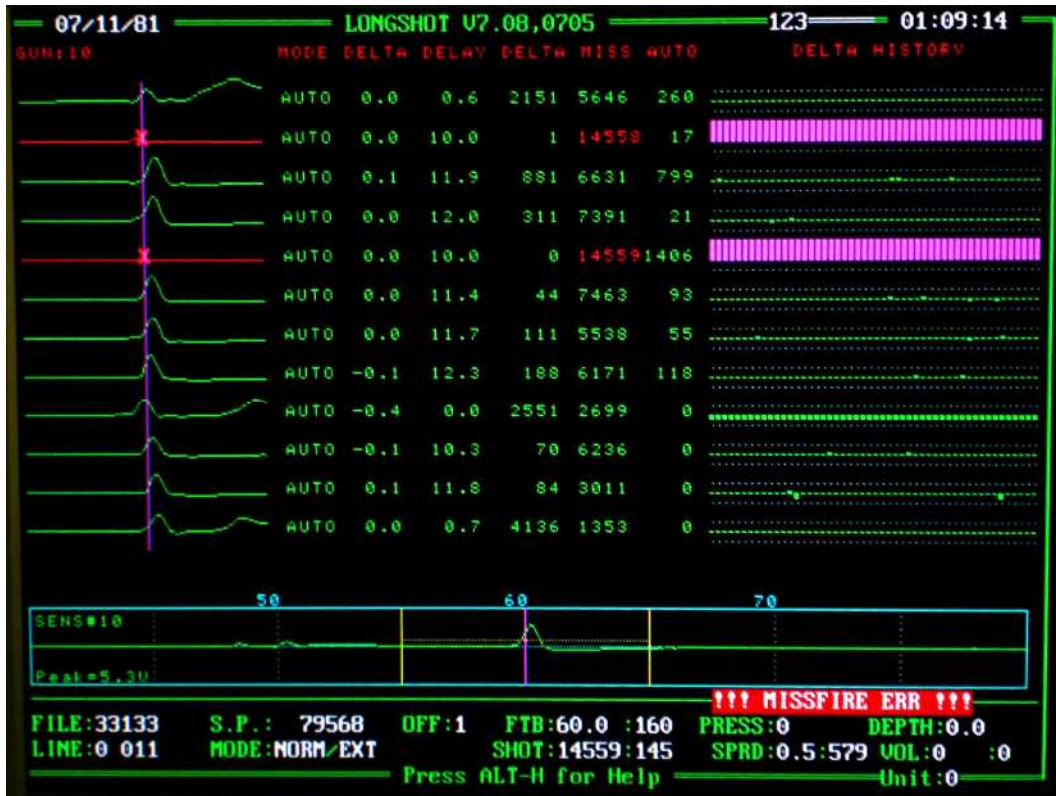

Figure 7: A typical screen from the *LongShot* software running on the Real Time Systems Controller Module. The signal from each individual airgun from the previous shot is displayed left, the vertical pink line identifying the target time for the leading edge of each pulse. Delay times and other gun statistics are given for each gun as text. The firing history for the previous 50 shots of each gun, in terms of its accuracy relative to the target time, is shown graphically on the right: small green bars mean the leading edge of the gun's signal matches the target time; larger green bars (e.g., for gun 9, counting down from the top of the display) indicate a small time discrepancy; large pink or purple bars indicate serious misfires. Note that at this point in the survey gun 5 is turned off and the sensor on gun 2 has failed. At the bottom of the screen is a detailed display for one gun (gun 10 in this example), and the shot number is displayed bottom-centre.

The timing of the gun trigger pulses came from a GPS time base. The Zyfer GPStarplus clock uses a GPS disciplined ovenized quartz oscillator and is accurate to better than 1 μ s indicated by a Time Figure Of Merit value (TFOM; Table 2). The clock provided a 500 ms-wide trigger pulse to the Real Time Systems Controller Module, at a period of either 60 s, 20 s, 19 s or 18 s, depending on the survey (see individual results sections for details). The Controller Module is triggered by a falling pulse edge. For example, if the Zyfer clock creates a trigger pulse at a 30 s mark, the guns are fired at:

$$30 \text{ seconds} + 500 \text{ ms pulse width delay} + 60 \text{ ms } LongShot \text{ delay} = 30.560 \text{ s}$$

TFOM value	Time Error
4	$\leq 1 \mu\text{s}$
5	$> 1 \mu\text{s}$ to $\leq 10 \mu\text{s}$
6	$> 10 \mu\text{s}$ to $\leq 100 \mu\text{s}$
7	$> 100 \mu\text{s}$ to $\leq 1 \text{ ms}$
8	$> 1 \text{ ms}$ to $\leq 10 \text{ ms}$
9	$> 10 \text{ ms}$

Table 2: Time Figure Of Merit (TFOM) values for the Zyfer GPStarplus model 565 clock, and their meaning in terms of timing accuracy (Zyfer GPStarplus Model 565 User's Manual).

In case of an instability or failure in the GPS clock, to provide shot instances for OBS and seismic land stations, the trigger pulses from the Zyfer GPStarplus were recorded by an OBS logger (4x4 type) modified to fit into an instrument case (Figure 6). Once the multichannel seismic recording system was installed after the SO198-2 prologue, the logger was also set to record the TTL out signal from the Real Time Systems Controller Module used as the trigger pulse sent start the MCS recording system.



Figure 8: The airgun source. This sequence of photographs shows, from left to right, the evolution of the guns firing from the shot through the air bubble rising and spreading out at the surface.

Operational issues with the seismic source

The seismic source proved effective and reliable, producing nearly 100,000 shots. However, a number of issues were apparent that affected the operation of the source:

1. Airgun failures, while less frequent than during SO198-1, still occurred as a result of burst hoses. Since the air pressure was reduced to 150 bar during SO198-2, the failures that occurred throughout SO198 were most likely caused by abrasion of the hoses against the towing

equipment (Figure 4). This may be avoided by either rerouting/shortening the hoses or by using armoured hoses.

2. Time break sensors on the airguns were not reliable. During the shooting periods, at best two sensors failed altogether with one or two others producing suspect signals, while at worst six failed (half the total number of sensors). The airgun array would often be deployed with many sensors initially failing to work, but for them to gradually start working over a period of 6-12 hours use. Numerous attempts were made to rectify the problem including checking the cabling to the sensors and, between deployments, the sensors themselves, but the problem was not fully resolved. The affect of these failures was that the source could not be satisfactorily tuned, and a number of the airguns had to be fired using manual 'best guess' timing.
3. The lack of depth sensors on the airgun array meant that the source depth could only be estimated from the length of the ropes attached to the floatation buoys. The tow-depth has a significant affect on the source signature, and it is important to keep this constant during data acquisition, but no quality control was possible due to the lack of sensors.

Multichannel Seismic (MCS) system

The multichannel seismic (MCS) system was a Sercel Seal, provided and operated by Exploration Electronics Limited of Great Yarmouth, U.K. The system is described in two parts, the deck and out board equipment, primarily the streamer, and the laboratory based data acquisition system.

Streamer

The streamer used was a 2.4 km, 192-channel fluid filled digital streamer. The streamer is arranged into 16 active line sections (ALS), each 150 m long and containing 12 channels. Each channel is composed of 16 hydrophones in a 12.5 m long group.

A total of nine depth control birds were evenly spaced along the streamer: bird 1 at 3.55 m in front of the first active line section (9.8 m in front of the centre of channel 1); bird 2 in the centre of channel 24; bird 3 in the centre of channel 48 etc. to bird 9 in the centre of channel 192 (Table 3). The streamer was nominally towed at 10 m depth, although ship speed, sea conditions and the amount of weight attached to the streamer caused it to often be at a shallower depth.

A radar reflector was fitted to the tail buoy to provide feather angles from the ship's radar system.

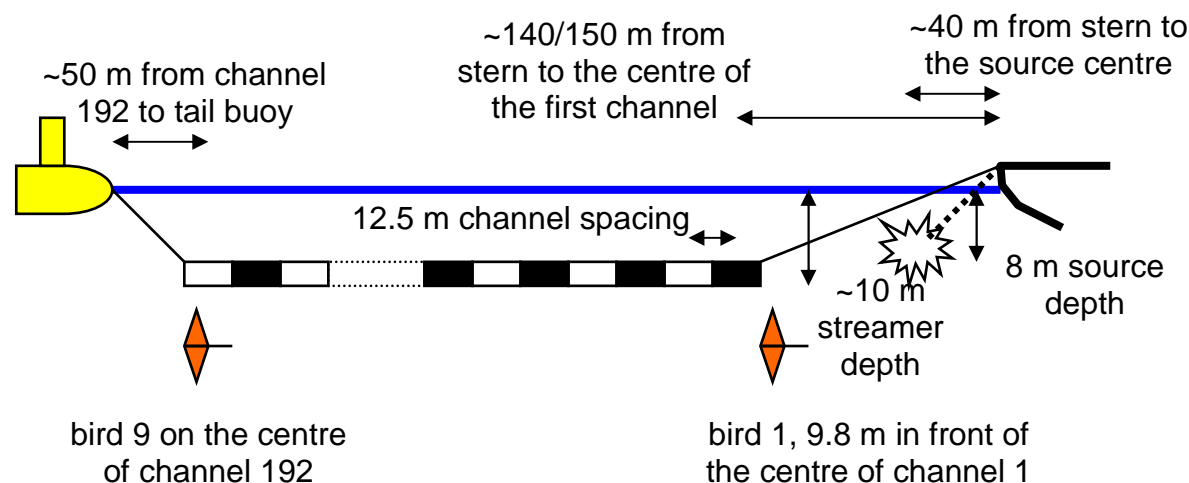

Figure 9: Seismic source and multichannel streamer geometry. The streamer has 192 channels at 12.5 m spacing, for a total length active of 2387.5. The first source-reciever offset was 100 m during the SUMD profiles, and 110 m for all subsequent profiles. Depth control birds were located 9.8 m in front of the centre of channel 1, on channel 24, then every 24 channels to place the ninth bird on channel 192 (Table 3).

Bird number	Channel centre
1	9.8 m in front of 1
2	24
3	48
4	72
5	96
6	120
7	144
8	168
9	192

Table 3: Bird locations along the streamer in relation to the channel number at the centre of which they are fixed.

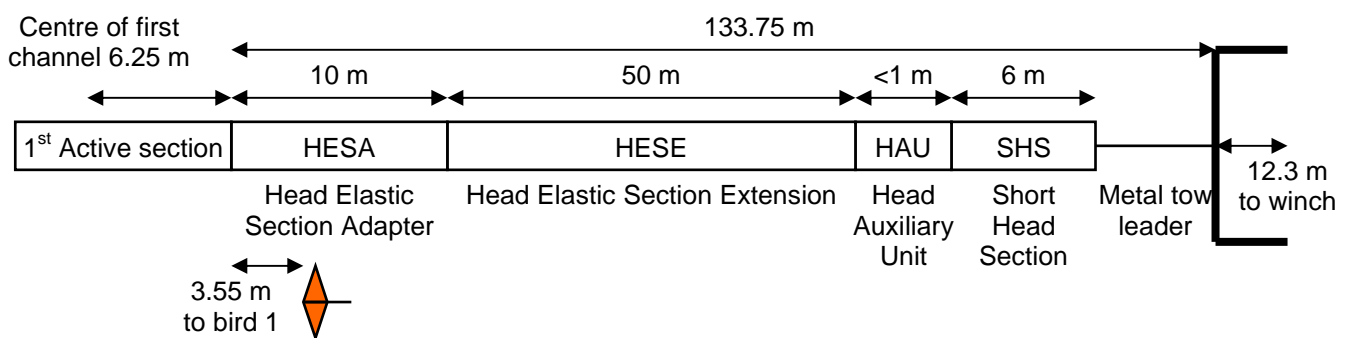

Figure 10: Schematic diagram for the front of the multichannel streamer, as far as the first active section.

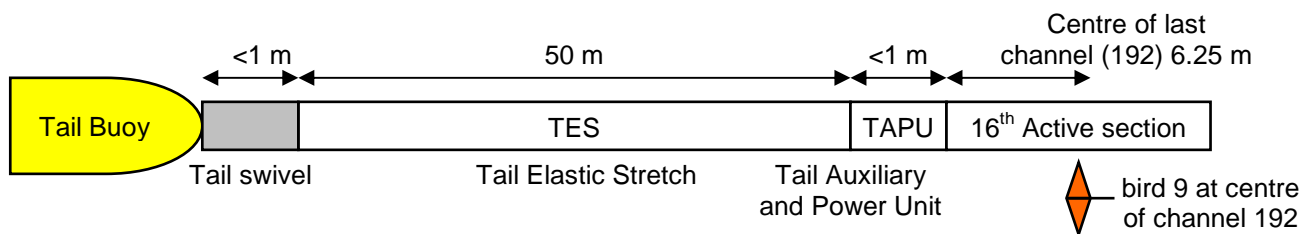

Figure 11: Schematic diagram for the end of the multichannel streamer, from the last active section to the tail buoy.

Data acquisition system

Data were acquired from the streamer using a Sercel SealXL 5.1 system (Figure 12). The SealXL system acquires the data, provides real-time quality control displays, paper hard copy and digital recording to tape and disk. The digital records are in SEG-D format, with 16 s record length at 2 ms sample rate. The acquisition system was synchronised to start recording using the TTL out connection on the Real Time Systems Controller Module for the airguns.

Quality control displays include a continuous display of signal strength at every channel along the streamer, the current shot gather, and a single

channel history display (Figure 13). Every 150th shot gather and the single channel record (channel 5) are printed on a pair of thermal printers.

Each shot gather is recorded immediately after acquisition to a separate file on the Seal system, two network attached storage (NAS) drives and to an FTP server. The IBM 3590 tape drives, both primary and spare, failed to record data reliably and were not used.



Figure 12: The multichannel seismic acquisition system. The system comprises of a number of workstations and streamer interface boxes (below the bench and the silver box behind the monitors), four main display screens (Figure 13), an IBM 3590 tape drive (grey box to the right of the screens, beneath the fan) and a pair of thermal plotters to plot shots gathers and a single channel record (cream coloured boxes at extreme right).

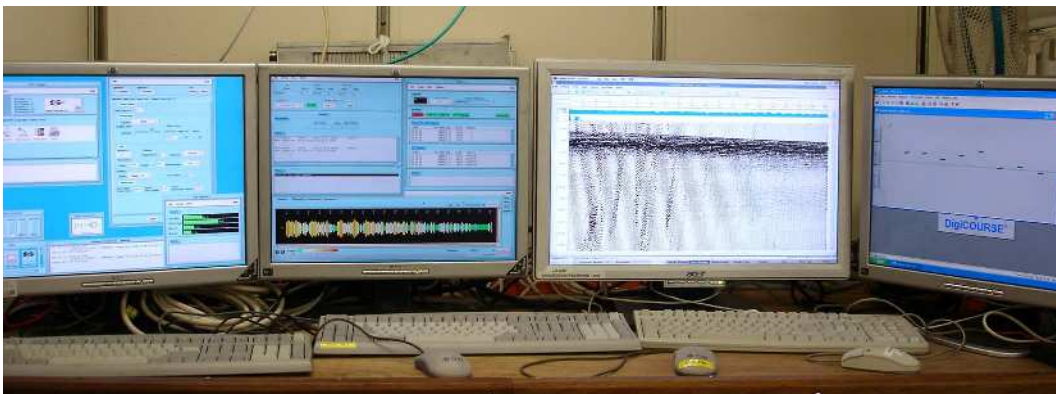

Figure 13: The multichannel seismic (MCS) acquisition system control screens (left and centre left), shot gather display for quality control (centre right), and the bird controller display (right).

Ship-board MCS processing

Two seismic processing systems were used. The MCS lines acquired for the University of Southampton (designated SUMD and SUME) were processed using *ProMAX*, those acquired for the University of Texas (designated SUMUT) were processed using *Focus*. In both cases, all the individual SEG-D shot gathers for an entire line were combined into a single file using the Unix `cat` command, and this file was imported into the respective software package. Both processing schemes use 6.25 m CMP bins to give an average fold of ~25.

The *ProMAX* processing scheme:

1. Desample: 4 ms
2. Apply geometry using the *2D Marine Geometry Spreadsheet*.
 - a. Export all the shot times from the SEG-D data and calculate the ship position at each time from the ship's 1-second navigation data
 - b. Determine the average line azimuth and then project, from each ship position, the location of the source and each receiver channel behind the ship (line azimuth-180°)
 - c. Calculate the midpoints for every source-receiver pair and bin them into 6.25 m bins along the line azimuth
3. Bandpass filter: 3-5-60-120 Hz (minimum phase Ormsby)
4. Amplitude recovery: time^2
5. Predictive deconvolution: minimum phase with 250 ms operator and 128 ms gap length
6. NMO correction: velocity analyses every 800 CMPs
7. Stack: median

The data were then plotted using Seismic Unix with the following enhancements:

1. Automatic gain control (AGC): 5-second Gaussian weighted
2. Top mute: 100 ms above the seafloor

The *Focus* processing scheme:

1. Define geometry
 - a. Export shot times from focus and calculate ship's position at each time from 1-second navigation data
 - b. Calculate the average shot spacing
 - c. Define station locations every 1.25 m along a line
 - d. Call *PATTERN* to define receiver locations relative to the sources
 - e. Call *SOURCE*
 - i. Define the first shot location such that the far offset receiver is at station 1
 - ii. Set the shot spacing to even number of stations
2. Desample: 4ms
3. Bandpass filter: 3-5-60-120 Hz (minimum phase)
4. Amplitude recovery: time^2

5. Multichannel predictive deconvolution: minimum phase with 11 trace window, 250 ms operator and 128 ms gap length
6. NMO correction: velocity analyses every 500 CMPs
7. Top mute: picked during interactive velocity analysis, ~0.5s above the seafloor
8. Time-frequency noise suppression: *TFCLEAN* module, scales groups of three traces to the median amplitude within the 3-25 Hz frequency band
9. Stack: median

The data were then plotted using the *Focus* module *PSPLOT*, which output a PostScript file. Plots were made with an Automatic gain control (AGC) window of 1 second.

Expendable Bathythermographs (XBTs)

Expendable bathythermograph probes provide a measure of water temperature versus depth, which is used to calculate the acoustic velocity structure of the water beneath the vessel. The acoustic velocity structure of the water column is the main control on the path followed by any acoustic energy produced by equipment located on, or towed by, the vessel including the swath bathymetric system and the seismic airguns. An XBT probe was launched after the deployment of each OBS instrument in order to provide an even distribution of measurement locations over each survey area.

An XBT probe consists of a weighted temperature sensor, hydro dynamically shaped to descend at a constant known velocity. The probe has a metal nose that provides a grounding path to the data acquisition system on the ship, which is triggered when the probe hits the water. Temperature is measured with an integrated thermistor and sent to the data acquisition system along a two-conductor insulated wire. Probe depth is calculated from the time elapsed since the probe entered the water. Acoustic velocity is calculated from temperature using Equation 1 (Chen and Millero, 1977; Fofonoff and Millard, 1983), which also requires the salinity of the water. Since salinity is not measured by an XBT, an average value of 35 ppt was estimated from the CTD drop (see previous section).

$$Velocity = C + (A + B \times \sqrt{S} + D \times S) \times S$$

Equation 1

Where:

$$salinity(S) = 35 \text{ ppt}$$

$$pressure(p) = depth \times 3.2808 \times 0.03048$$

$$A = ((A_3 p + A_2) p + A_1) p + A_0$$

$$A_0 = (((-3.21t \times 10^{-8} + 2.006 \times 10^{-6})t + 7.164 \times 10^{-5})t - 0.01262)t + 1.389$$

$$A_1 = (((-2.0122t \times 10^{-10} + 1.0507 \times 10^{-8})t - 6.4885 \times 10^{-8})t - 1.258 \times 10^{-5})t + 9.4742 \times 10^{-5}$$

$$A_2 = ((7.988t \times 10^{-12} - 1.6002 \times 10^{-10})t + 9.1041 \times 10^{-9})t - 3.9064 \times 10^{-7}$$

$$A_3 = (-3.389t \times 10^{-13} + 6.649 \times 10^{-12})t + 1.1 \times 10^{-10}$$

$$B = B_0 + B_1 p$$

$$B_0 = -0.01922 - 4.42t \times 10^{-5}$$

$$B_1 = 7.3637 \times 10^{-5} + 1.7945t \times 10^{-7}$$

$$C = ((C_3 p + C_2) p + C_1) p + C_0$$

$$C_0 = (((3.1464t \times 10^{-9} - 1.478 \times 10^{-6})t + 3.342 \times 10^{-4})t - 0.0580852)t + 5.03711)t + 1402.388$$

$$C_1 = (((-6.1185t \times 10^{-10} + 1.3621 \times 10^{-7})t - 8.1788 \times 10^{-6})t + 6.8982 \times 10^{-4})t + 0.153563$$

$$C_2 = (((1.0405t \times 10^{-12} - 2.5335 \times 10^{-10})t + 2.5974 \times 10^{-8})t - 1.7107 \times 10^{-6})t + 3.126 \times 10^{-5}$$

$$C_3 = (-2.3643t \times 10^{-12} + 3.8504 \times 10^{-10})t - 9.7729 \times 10^{-9}$$

$$D = 1.727 \times 10^{-3} - 7.9836p \times 10^{-6}$$

XBT launcher and data acquisition system

The XBT system comprised of a hand-held launcher (Figure 14) and Lockheed Martin Sippican, Inc. MK21 I/O module (serial number 00157, running June 14th 2007 firmware) connected via USB to the same PC used to run the *Caris HIPS and SIPS* swath bathymetry processing software (Figure 15).



Figure 14: The XBT hand-held launcher ready with a T-7 probe in its launch tube (bottom), and an unused T-5 probe (top).

The data acquisition software was WinMK21 SURFACE version 2.10.1 that includes MK21COEF version 2.9.1 and MK21AL version 2.13.1. The software was configured to automatically save an Export Data File (EDF) and automatically backup data as it was acquired. The workstation was connected to the vessel's NMEA GPS feed to provide the location of each launch. The clock on the workstation was manually synchronised to GPS at the start of the cruise and provided the time-tag for each launch.

The hand-held launcher was connected to a deck connection box located on the main deck directly behind the *luftpulsstation* (Figure 16). The probes were deployed over the port rail adjacent to the deck connection box (Figure 17).

The launch of each probe creates two files on the workstation, for example:

T7_00051.RDF	–	WinMK21 format file
T7_00051.EDF	–	Export Data File in plain text format

The first two characters in the name identify the probe type followed by the *Sequence Number*, which increments with the deployment of every probe regardless of type. The EDF file contains all the

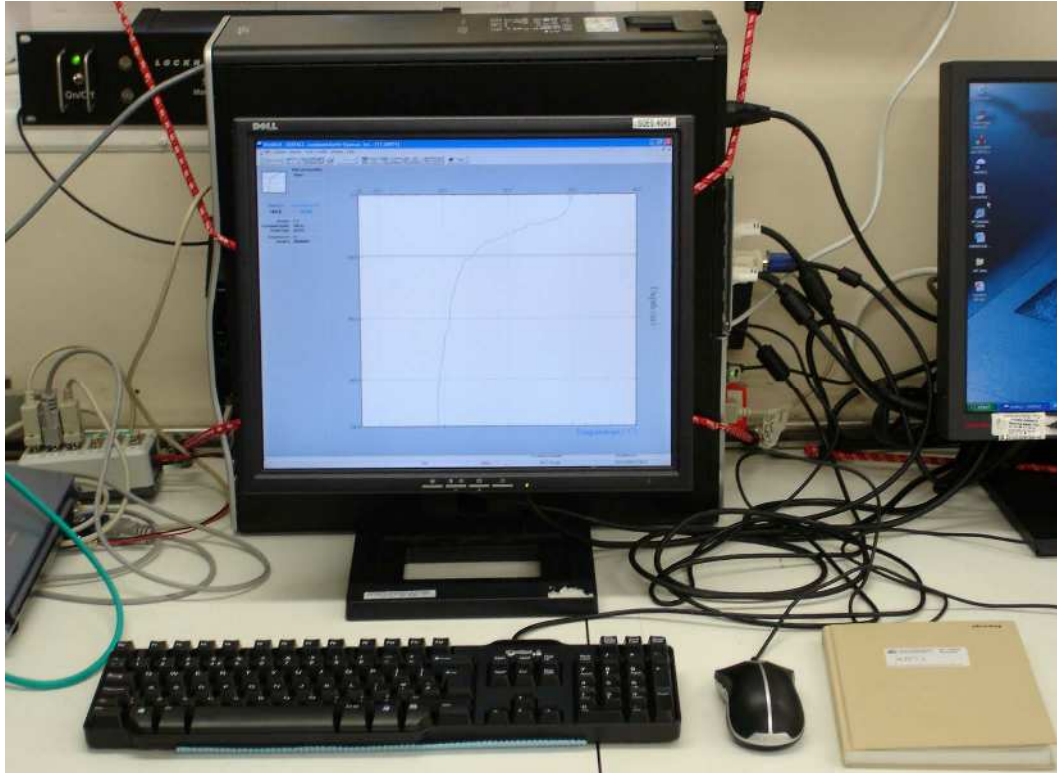

Figure 15: The XBT data acquisition system with the WinMK21 SURFACE software displaying the temperature profile resulting from the launch of a T-7 probe to the maximum depth of 760 m. The MK21 I/O module is visible behind the workstation, toward the top-left of the picture.

Two types of XBT probe were deployed during SO198-1: T-7 probes capable of providing data to a maximum depth of 760 m; and T-5 probes with a maximum depth of 1860 m (Figure 14). Specifications for each type of probes, provided by the logging software, dictated that T-5 probes could only be deployed while the vessel was travelling at less than 6 knots through the water; T-7 probes could be deployed at up to 15 knots, i.e. at any operating speed for the Sonne.

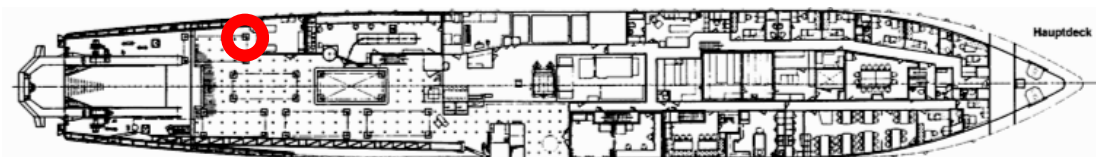

Figure 16: The launch location for XBT probes, on the main deck directly behind the *luftpulsstation*.



Figure 17: An XBT probe being deployed using the hand-held launcher. Photo by J. Bull.

Operational issues with the XBT system

1. The relatively short length of cable hard-wired to the launcher dictated that the probes could not be launched over the stern of the vessel, which would be the most desirable location to ensure a clear path for the trailing signal cable while the vessel is underway. A 10-metre extension cable between the launcher and the deck connection box would solve this problem.
2. The deck connection box is not rain/waterproof.
3. The WinMK21 has a couple of issues:
 - a. The sequence number, displayed when loading a new probe, is one less than will be written to the final data file for that probe.
 - b. The software expects administrative rights on the workstation and a normal user is not permitted to write data files to the default storage locations.

Swath bathymetry (Simrad EM120)

The Simrad EM120 system acquires swath bathymetric and backscatter data. The EM120 system is a 12 kHz multibeam echosounder designed for deep-water mapping. It forms 191 beams using of an array of transducers built into the hull of the Sonne (Figure 18).

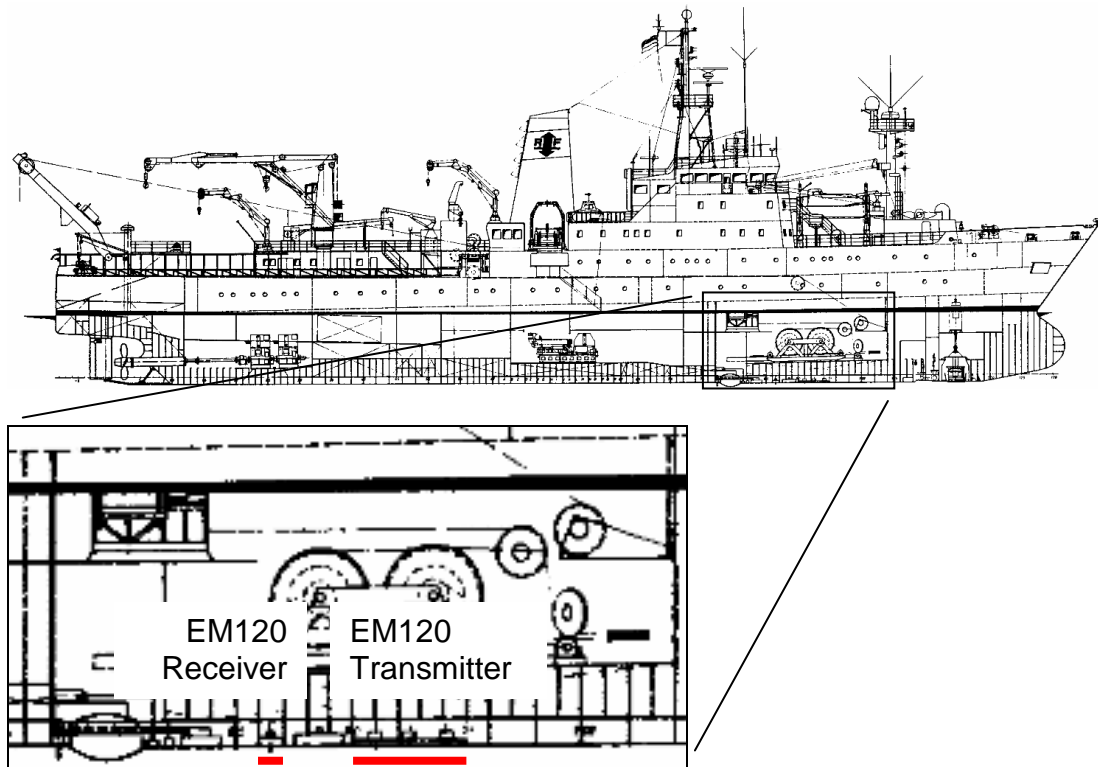

Figure 18: Location of the EM120 transmitter and receiver transducers in the Sonne's hull.

The EM120 system incorporates data from the GPS navigation system and the Motion Reference Unit (MRU) to account for the location and orientation of the ship (Figure 19). The system provides a 1° beam width resulting in a seafloor resolution of, for example, 50 m x 50 m in ~3000 m water depth.

The swath data were loaded into Caris HIPS & SIPS (version 6.1) software for gridding and display using the following scheme:

1. The Caris Conversion Wizard was used to load the raw data
2. A sound-velocity correction was applied based on the velocity profile acquired during SO198-1 from XBT sequence number 1, extended in depth to account for the deep velocity structure, depending on location relative to the trench (Figure 20, Table 4 and Table 5)
3. A zero-tide correction was applied
4. A swath/sweep filter rejects soundings with a beam-to-beam slope of $>25^\circ$ and swaths were edited by hand
5. Data were gridded at 50 m and interpolated using a 5x5 grid where at least 10 grid nodes are populated



Figure 19: The EM120 Installation Menu, showing the settings used during data acquisition on SO198-1.

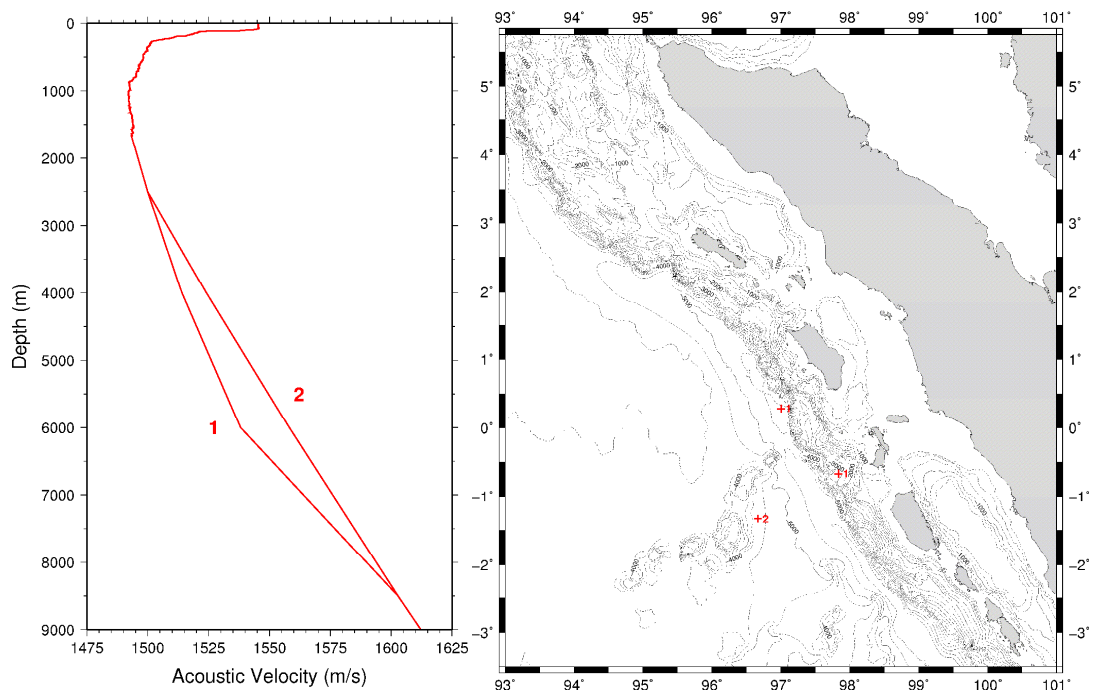

Figure 20: Sound-velocity profiles 1 and 2 (left panel) used to perform the slant-range correction for the swath bathymetric data, and their locations (right panel), as entered into the Caris software, where they were applied to the nearest data.

Depth (m)	Profile 1 velocity (m/s)	Profile 2 velocity (m/s)
2500	1500	1500
4000	1514	1524
6000	1538	1558
8500	1602	1602
12000	1669	1669

Table 4: Velocity profiles 1 and 2, used to extend XBT sequence number 1 for the slant-range correction of the swath bathymetric data. The two profiles were applied spacially to correct the nearest data; locations are given in Table 5.

Profile	Latitude	Longitude
1	0.26667	97.0
1	-0.66667	97.83333
2	-1.33333	96.66667

Table 5: Locations for velocity profiles 1 and 2 (Table 4) used to slant-range correct the swath bathymetric data.

Sub-bottom profiler (Parasound)

The *Parasound* system from Krupp Atlas Elektronik is a high-resolution sub-bottom profiler fitted to the *Sonne*. The system is comprised of a transducer unit built into the hull (Figure 21), a heave sensor, and an electronic control, data processing and logging system called *ParaDigMA*.

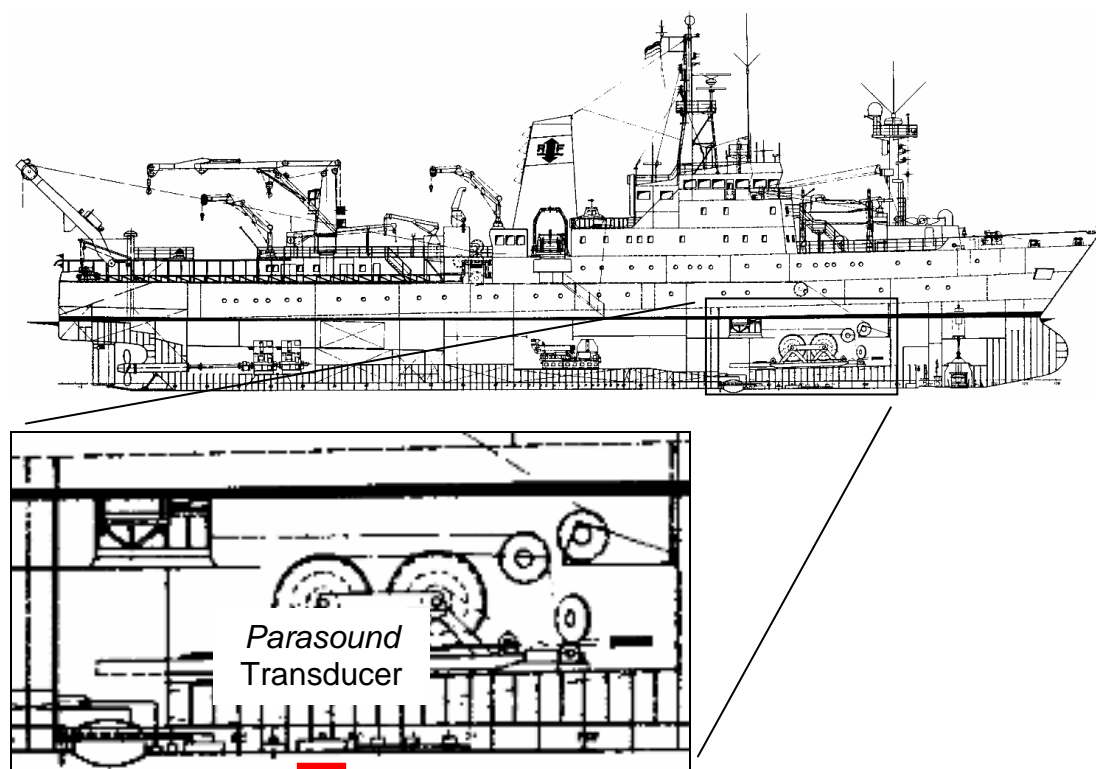

Figure 21: Location of the *Parasound* transducer in the *Sonne*'s hull.

The *Parasound* system uses the parametric effect that results from the non-linearity of the motion of acoustic waves in a fluid when signals with two different frequencies are transmitted simultaneously. One transmission frequency is fixed at 18 kHz while the second can be varied between 20.5 kHz and 23.5 kHz in increments of 0.5 kHz. The parametric signal in the water column has a frequency equal to the difference between the two transmitted frequencies, and this is the signal used for sub-bottom profiling.

The advantage of a parametric signal is that it has a relatively high lateral resolution; the signal is emitted within a cone as narrow as 4° and samples an area of the seafloor with a diameter approximately equal to 7% of the total water depth. The disadvantage of a parametric system is that it cannot detect a signal reflected from a layer dipping at more than 2° ; this is a significant problem in areas with steep slopes such as continental margins.

During SO198-1 the second signal was set to a frequency of 22 kHz resulting in a parametric signal with a frequency of 4 kHz. The system was set up to assume an acoustic water velocity of 1.5 km/s. The depth to the transducer was set to 6.5 m in the *ParaDigMA* software; this value is slightly different to that used by the EM120 (4.13 m). The *Parasound* system obtains heave data

from the Sonne's MRU and uses its own dedicated pitch and roll sensor to automatically correct the data for the motion of the ship.

A data sample rate of 40 kHz (25 μ s sample interval) is required to record the high frequency source wavelet. The high data sample rate and large range of depths over which the *Parasound* system can be operated would result in huge volumes of data being produced. To keep the volume of data to a manageable level, the *Parasound* system employs windowed recording. The recording window is 200 m long (10640 samples assuming 1.5 km/s) and the start of the window is set in depth on the Operator Console (Figure 22). Unfortunately the recording window does not automatically track the seafloor reflection and must be adjusted manually by the operator as the water depth changes.

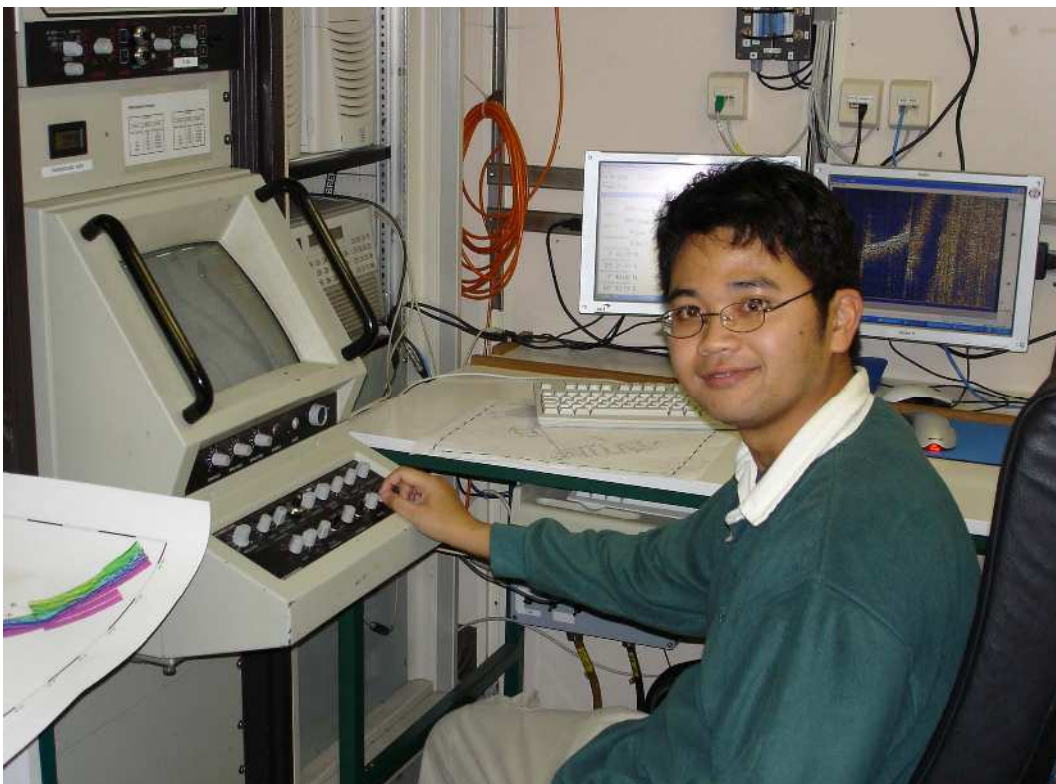

Figure 22: The *Parasound* Operator Console (left), and the *ParaDigMA* data processing and logging system display (right).

Converting *Parasound* data to SEG-Y format

The *Parasound* system stores data in a format similar to SEG-Y where each record consists of a trace header containing pertinent information such as date, time, location, etc., followed by the trace data as a series of floating point numbers. While the trace header does conform to the SEG-Y standard, the extended header (bytes 181-240) is used to store information vital to the use of the data (see Table 6). However, there are a couple of crucial incompatibilities to SEG-Y in the rest of the format:

1. The SEG-Y EBCDIC and binary reel headers are missing from the start of the file.
2. The trace data are stored in a compressed 2-byte integer format.

The trace time-series data format saves data space by separating each sample into a 12-bit mantissa, 1-bit sign, 2-bit exponent used to represent four different gain ranges, and an overflow bit (Figure 23).

Bit number:	15	14	13	12	11	10	9	8	7	6	5	4	3	2	1
Content:	Ov.	Exponent		Sign		Mantissa									

Figure 23: The compressed 2-byte integer format employed by the *Parasound* system to store each data sample.

The following FORTRAN code, based on the suggested scheme in Appendix B of the ParaDigMA User and Reference manual (Atlas Elektronik GmbH, 1994), was used to convert trace data into an array of 4-byte floating-point numbers:

```

program paraconv
integer a, samples
integer*2 idata
real*4 output
open(unit=10,file='wigggle_para',form='unformatted',
& access='direct', recl=2)
open(unit=11,file='samples')
read(11,*) samples
do 20 a=1,samples,1
  read(10, rec=a) IDATA
  call decpack(idata, output)
  write(6,*) output
20 continue
end

SUBROUTINE DECPACK ( IDATA, VOLT )
REAL*4 F, VOLT
INTEGER*2 IDATA, NGESAMT, IA, J, IBB
INTEGER*2 IMANT, ISIG, IRANG, IB
DIMENSION F(4)
SAVE F
DATA F / 256., 32., 4., 1. /
IBB = IDATA
IB = IBCLR ( IBB,15 )
IMANT = MOD ( IB,4096 )
ISIG = MOD ( IB / 4096 , 2 )
IRANG = IB / 8192
VOLT=FLOAT(IMANT)*(2.5/F(IRANG+1))*FLOAT(1-ISIG*2)
RETURN
END

```

Trace header values

The *Parasound* system makes extensive use of the trace header in order to store many useful system settings. The full set is listed in Appendix B of the ParaDigMA User and Reference manual (Atlas Elektronik GmbH, 1994), and reproduced in a modified form with the actual start-byte for each header value in Table 6.

Start byte (format)	Value (v=variable)	Description
1 (I4)	v	Shotpoint
5 (I4)	v	Shotpoint
9 (I4)	v	Shotpoint
17 (I4)	0	Source type
29 (I2)	1	Trace indicator: Seismogram
31 (I2)	1	No. of vertically summed traces
33 (I2)	1	No. of horizontally summed traces
35 (I2)	1	Data use: production
37 (I4)	0	Distance source point to receiver group
41 (I4)	0	Receiver group elevation
45 (I4)	0	Surface elevation at source
49 (I4)	0	Source depth below surface
53 (I4)	0	Datum elevation at receiver group
57 (I4)	0	Datum elevation at source
61 (I4)	v	Depth <i>Parasound</i> in metres x10
65 (I4)	v	Depth <i>Hydrosweep</i> in metres x10
69 (I2)	-10	Scaler (divisor) for depth
71 (I2)	-10	Scaler (divisor) for coordinates
73 (I4)	v	Source coordinate – longitude: in arc seconds x10
77 (I4)	v	Source coordinate – latitude: in arc seconds x10
81 (I4)	v	Source coordinate – longitude: in arc seconds x10
85 (I4)	v	Source coordinate – latitude: in arc seconds x10
89 (I2)	2	coordinates in seconds of arc x10
105 (I2)	0	Lag time A
107 (I2)	0	Lag time B
109 (I2)	v	Additional delay in ms
115 (I2)	v	Number of samples
117 (I2)	v	Sample rate in μ s
119 (I2)	0	Gain type floating: no
127 (I2)	v	<i>Parasound</i> frequency in Hz
129 (I2)	v	<i>Parasound</i> frequency in Hz
131 (I2)	v	Signal length in ms
157 (I2)	v	Year
159 (I2)	v	Month x100 + Day
161 (I2)	v	Hour
163 (I2)	v	Minute
165 (I2)	v	Second x100 + hundreds of ms
167 (I2)	2	Time = GMT
181 (I4)	v	<i>Parasound</i> – Depth x10 in m
185 (I2)	v	Range in m
187 (I2)	v	Ship's speed x10 in knots
189 (I2)	v	Course [°] x10
191 (I2)	v	Heading [°] x10
193 (I2)	v	Reception window in m
195 (I2)	v	0/1 x10 – parametric mode
197 (I2)	v	Source frequency in kHz x10
199 (I2)	v	No. of pulses x10
201 (I2)	v	Bottom TVC x10
203 (I2)	v	0/1 x10 – NBS mode
205 (I2)	v	NBS frequency in kHz (18/33) x10
207 (I2)	v	NBS opening angle (2/4/20)x10
209 (I2)	v	NBS pulse length (up to 25ms) x10
211 (I2)	v	NBS gain (1-5 for 1, 10, 100, >, >>)
213 (I2)	v	0/1 x10 – Pilot tone mode

Table 6: Parasound SEG-Y header values.

Data processing

A basic processing sequence for *Parasound* data should include a static correction to align the variable recording window in time. The static correction is derived from the *Reception Window* setting, in metres, on the Operator Console, and stored as a 2-byte integer format starting at byte 193 of the trace header. The data benefit substantially from an Instantaneous Amplitude calculation (Taner, Kohler and Sheriff, 1979), which removes the 'ringyness' inherent in the raw data although at the expense of all signal polarity (Figure 24).

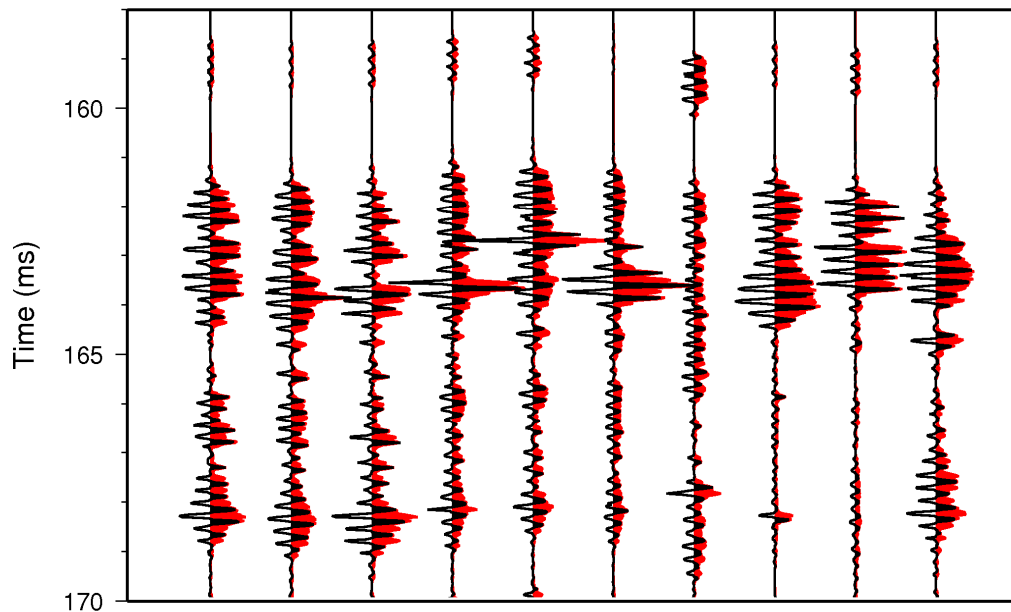

Figure 24: An example of raw *Parasound* data (black) superimposed on the same data after calculating instantaneous amplitude (red).

Gravity meter

Gravity was recorded continuously during SO198-1 on a LaCoste and Romberg marine gravity meter (S40). The meter was installed in the *Gravimeterraum* on deck II of the Sonne (Figure 25). The meter is mounted in a gyro-stabilised platform to keep it level at all times. The meter measures tension on a zero-length spring that is converted to digital gravity using a calibration constant of 0.992 and applies corrections for lateral accelerations. The logged data have a 5-minute averaging filter applied. Data are displayed every 10 seconds on the instruments control console and logged every 1 second to an internal hard disk. The control console could not be connected to the ship's systems and logs data versus an internal time base from a 200 Hz precision oscillator. The data were also logged every 1-minute using *HyperTerminal* software on a laptop PC connected to the serial output of the console.



Figure 25: The gravity meter S40 (left) installed in the *Gravimeterraum* on deck II of the Sonne with the control and logging console (centre) and the laptop PC used to capture 2-minute gravity data via an RS-232 serial connection (right; on the bench).

Cigading base station tie

Two gravity base stations were established in Indonesia prior to cruise SO198, by LIPI. The base stations, CDG1 & CDG2, are both located in the port of Cigading (Figure 26), ~20 km south of Merak.

On Julian Day 167, prior to SO198-2, four sets of measurements were taken with the portable LaCoste and Romberg gravity meter: (1) on the quay alongside the Sonne in Merak (Table 7; 6°00'52.3"S, 108°57'28.1"E measured by handheld GPS); (2) at base station CGD2 (Table 8); (3) at base station CGD1 (Table 9); (4) a repeat measurement back at the quay alongside the Sonne in Merak (Table 10). On Julian Day 213, at the end of SO198-2, the

Sonne was tied up in Merak at the same location as on Julian Day 167; the absolute gravity value at the ship was therefore assumed to be unchanged.

QuickTime™ and a
TIFF (Uncompressed) decompressor
are needed to see this picture.

Figure 26: Location of gravity base stations CGD1 and CGD2 in the port of Cigading. Detailed station locations are given in Figure 27 and Figure 28.

Reading number	Counter reading	Local time	UTC time
1	1710.79	08:00	01:00
2	1710.74	08:03	01:03
3	1710.85	08:05	01:05
4	1710.87	08:07	01:07
5	1710.89	08:09	01:09

Table 7: Merak Dockyard reading 1 on Julian Day 167.

Reading number	Counter reading	Local time	UTC time
1	1713.3	09:37	02:37
2	1713.26	09:38	02:38
3	1713.21	09:39	02:39
4	1713.24	09:40	02:40
5	1713.2	09:41	02:41

Table 8: Cigading base station CGD2 on Julian Day 167.

Reading number	Counter reading	Local time	UTC time
1	1713.06	09:49	02:49
2	1713.16	09:50	02:50

Table 9: Cigading base station CGD1 on Julian Day 167.

QuickTime™ and a
TIFF (Uncompressed) decompressor
are needed to see this picture.

Figure 27: Details for gravity base station CGD1 in Cigading, Indonesia.

QuickTime™ and a
TIFF (Uncompressed) decompressor
are needed to see this picture.

Figure 28: Details for gravity base station CGD2 in Cigading, Indonesia.

Reading number	Counter reading	Local time	UTC time
1	1710.85	10:33	03:33
2	1710.8	10:34	03:34
3	1710.83	10:35	03:35
4	1710.73	10:35	03:35
5	1710.75	10:36	03:36

Table 10: Merak Dockyard reading 2 on Julian Day 167.

The results of the gravity tie at 03:34 UTC on 15/06/08 (Julian Day 167) are as follows:

Absolute gravity at the quay	=	978145.57 mGal
Free air correction from quay to ship	=	0.775 mGal (3.6 m – 1.1 m)
Absolute gravity at the ship	=	978146.35 mGal
Ship's digital gravity meter reading	=	6388.2 mGal

The results of the gravity tie at 02:27 UTC on 31/07/08 (Julian Day 213) are as follows:

Absolute gravity at the quay	=	978145.57 mGal
Free air correction from quay to ship	=	0.7285 mGal (3.45 m – 1.1 m)
Absolute gravity at the ship	=	978146.30 mGal
Ship's digital gravity meter reading	=	6387.5 mGal

The total drift values for SO198-2 are thus:

Total drift	=	0.6535 mGal
Drift rate	=	0.014181858 mGal/day

Gravity meter clock drift

The clock on the S40 gravity meter was found to drift significantly versus UTC time against which all other systems on the ship were logged. Since the gravity data was logged on meter itself, the time offset between the meter's clock and UTC was measured and recorded approximately every hour during SO198-2. This was achieved by observing the 10-second update interval on the gravity meter's logging console and, using a watch or stopwatch, synchronising the update to a UTC display provided by a laptop PC in the *Gravimeterraum*, connected to the ship's clock. With practice, the time offset measured is estimated to be correct to ~1 second. The gravity meter's clock tended to lose time relative to UTC. The measured time offset is shown in Figure 29.

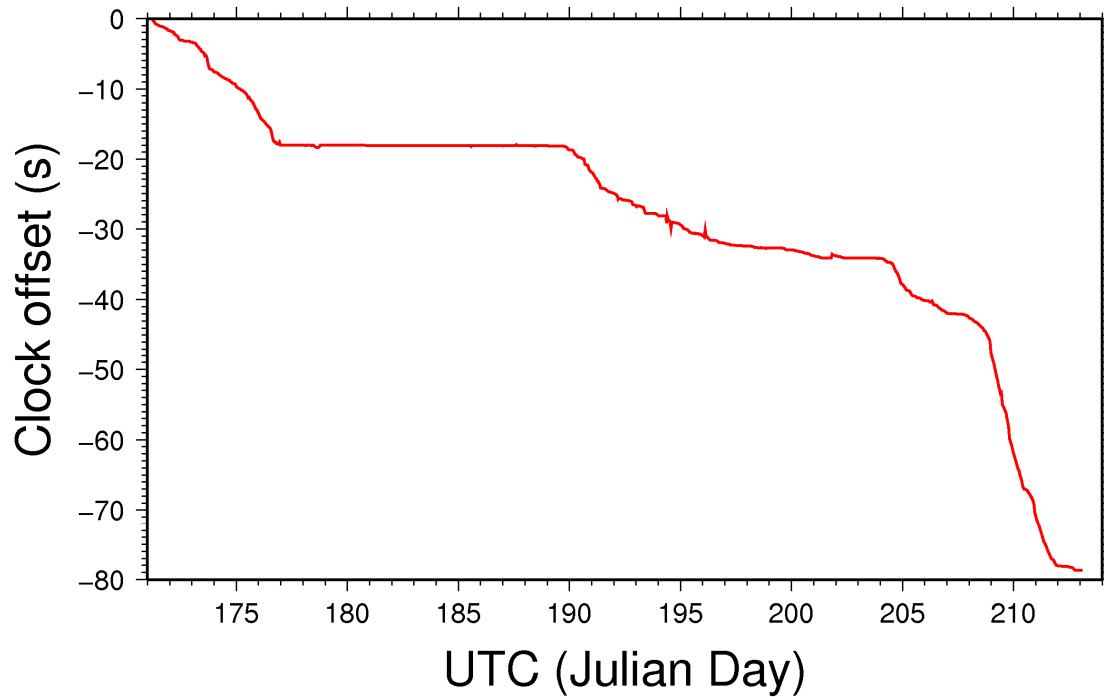

Figure 29: Time offset between the gravity meter clock and UTC during SO198-2. A negative offset means that the instrument's clock is behind UTC.

Gravity data reduction

The 1-second gravity data logged on the S40 internal disk was post-processed using the following scheme:

1. Meter clock drift corrected to UTC
2. Meter gravity drift corrected and resampled at 10 s interval UTC
3. Data merged with 1-second navigation data filtered with a 5-second Gaussian filter
4. Eötvös correction calculated using 1-second course and speed over ground data filtered with a 30-second median filter
5. Eötvös correction filtered using a 5-minute Gaussian filter and applied
6. Remove the regional gravity anomaly using the International Gravity Formula (IGF 1967)

Magnetometer

A *SeaSPY* proton precession magnetometer system was used to measure the total magnetic field. The system consists of a fish unit containing an Overhauser sensor, a deck mounted winch and tow cable, a *Smart Transceiver* interface module and a computer running *SeaLINK* software to visualise and log the data (Figure 30).

The logging PC was connected to the vessel's NMEA GPS feed to provide navigation information. Data were acquired at 1 Hz sampling. The clock used to tag the logged data, located in the *Smart Transceiver* interface, was manually synchronised to GPS time at the start of the survey.

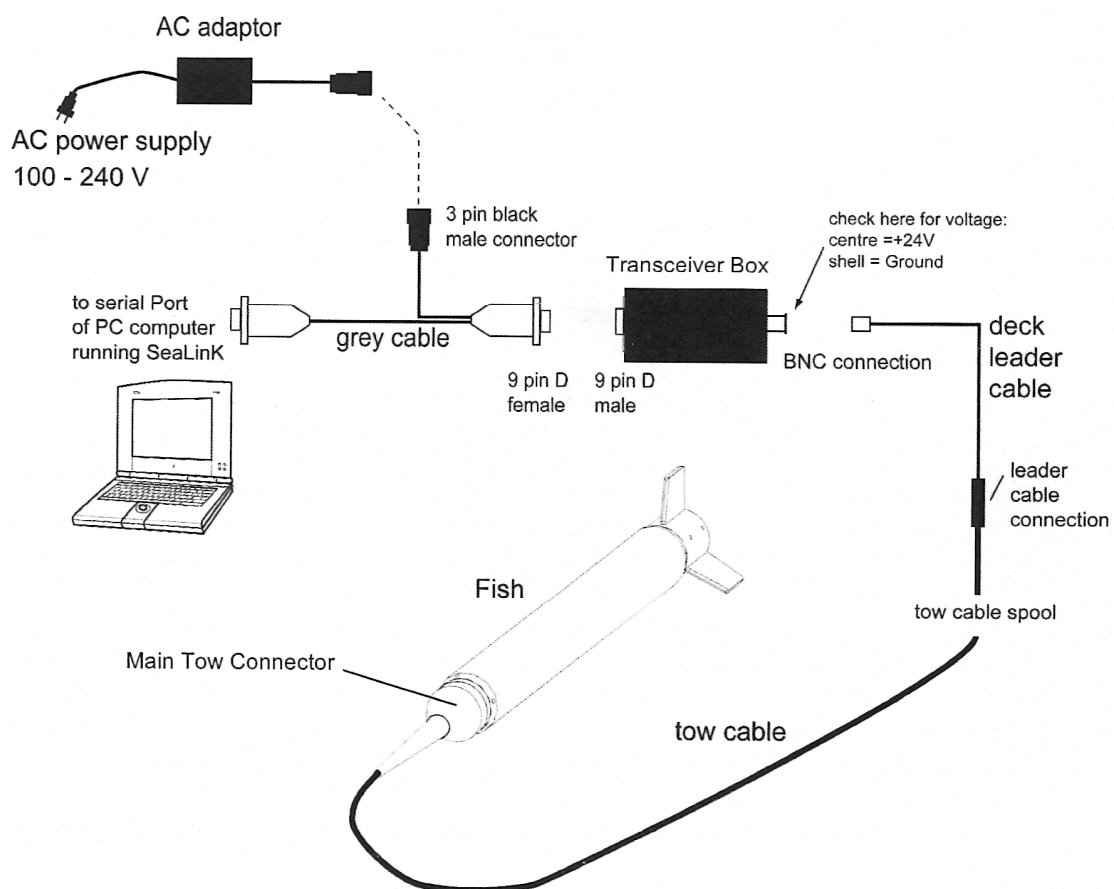

Figure 30: The *SeaSPY* total field magnetometer system (after Marine Magnetics Corporation, 2008).

Tow configuration

The fish was towed, using a set of pulley wheels tied to the end of the boom on the back-boat deck, on a 300 m cable from an electric winch attached to the deck (Figure 31). The location of the winch drum and the end of the boom that formed the towing point were measured using a tape (Figure 32 and Figure 33).

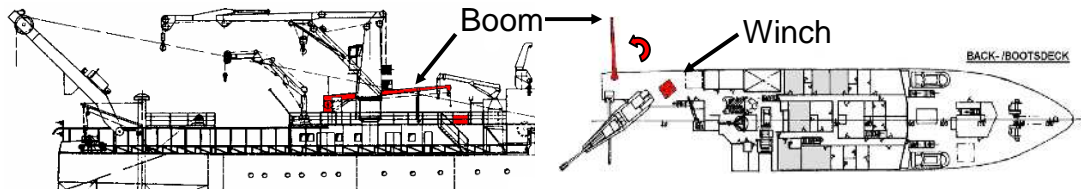

Figure 31: Location of the magnetometer winch and deployment boom on the port side of the back-boat deck, one deck above the main deck.

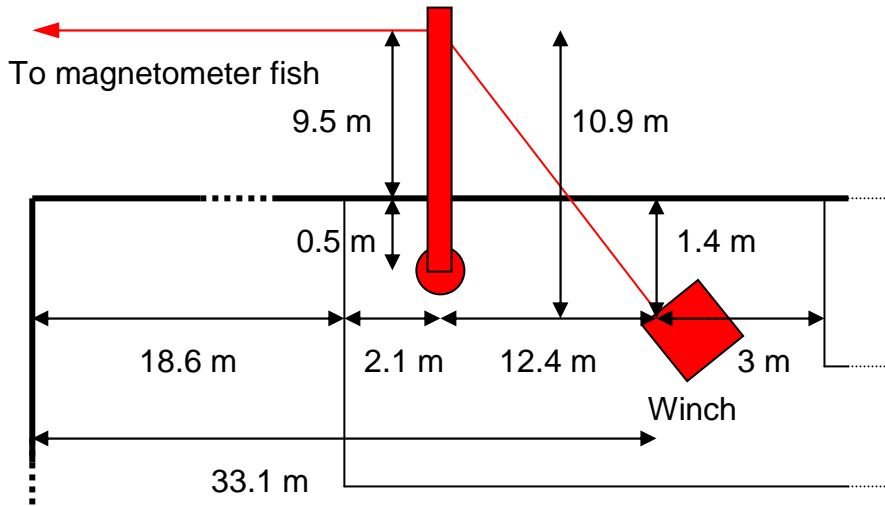

Figure 32: The location of the magnetometer winch and the towing point at the end of the rotating boom on the port side of the back-boat deck. Distances are given in metres relative to the tow point at the end of the extended boom, the point at which the cable leaves the winch drum, and the stern and port rail of the Sonne.

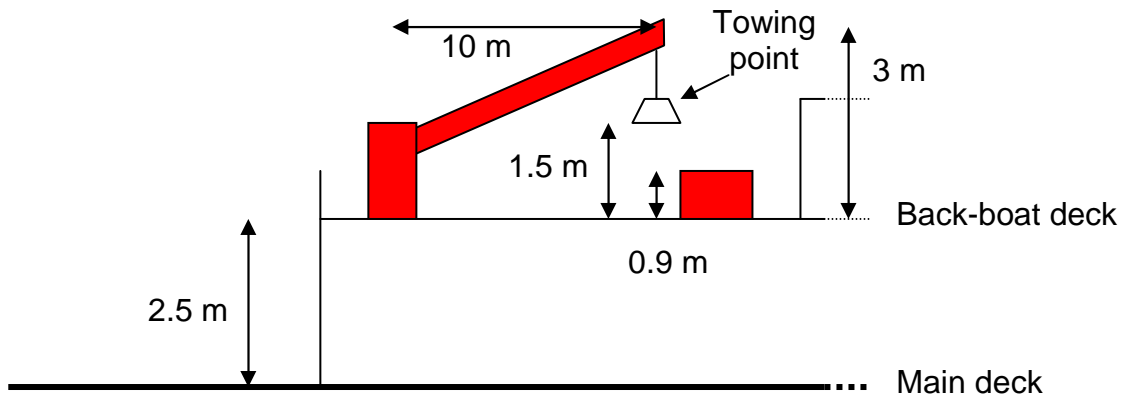

Figure 33: The height of the magnetometer winch, cable on the winch drum, and the towing point on the boom (not extended in this diagram) above the main deck of the Sonne. The water line is a further 3.5 m below the main deck.

Of the 300 m of tow cable, 19.5 m remained on the winch drum (circumference 0.75 m x 26 turns) and 16.5 m lies between the winch and the towing point on the end of the boom, leaving 264 m of cable between the towing point and the fish. At a nominal tow speed of 5 kt the fish will tow at ~7.5 m with 120 m of tow cable (Figure 34); assuming the same rate of increase in tow depth with cable length at 3 kt (Figure 35) and extrapolating to 264 m estimates a fish depth of 26 m. Given that this fish depth calculation

ignores the length of cable that is not in the water, and therefore not acting to depress the fish, between the towing point and the water line, the minimum estimate for the distance of the fish behind the towing point is 262 m.

In summary, including the distances in Figure 2, the magnetometer fish is:

1. ~17 m to port of the GPS navigation fixes
2. ~300 m behind the GPS navigation fixes

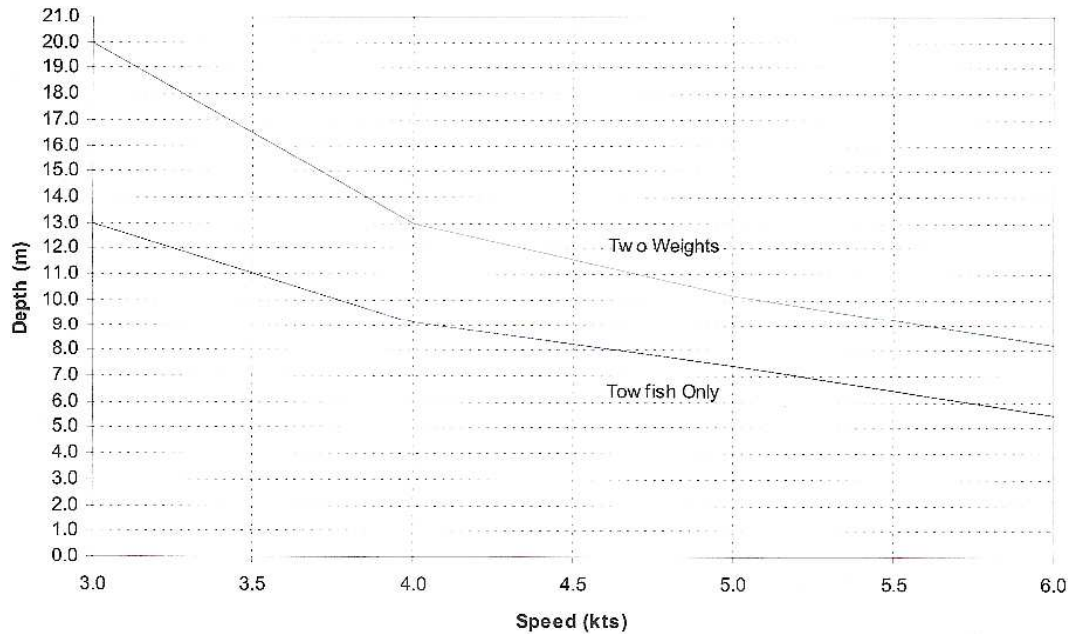

Figure 34: Towing depth of the SeaSPY tow fish versus towing speed with a 120 m tow cable. The un-weighted tow fish (bottom curve) represents the sensor used during SO198-1 (after Marine Magnetics Corporation, 2008).

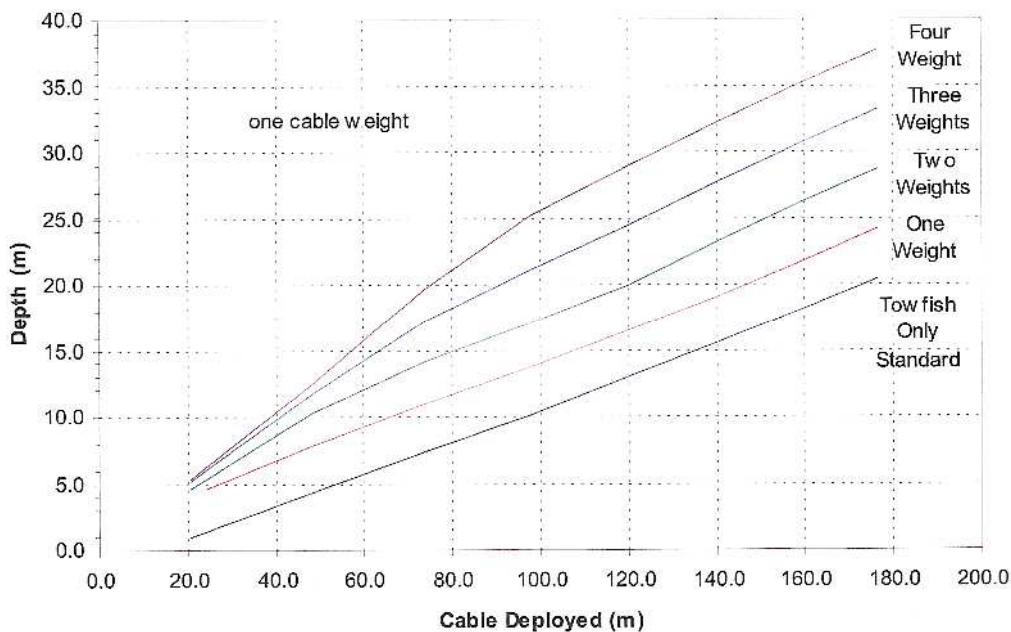

Figure 35: Towing depth of the SeaSPY tow fish at 3 kt towing speed. The un-weighted (standard) tow fish (bottom curve) represents the sensor used during SO198-1 (after Marine Magnetics Corporation, 2008).

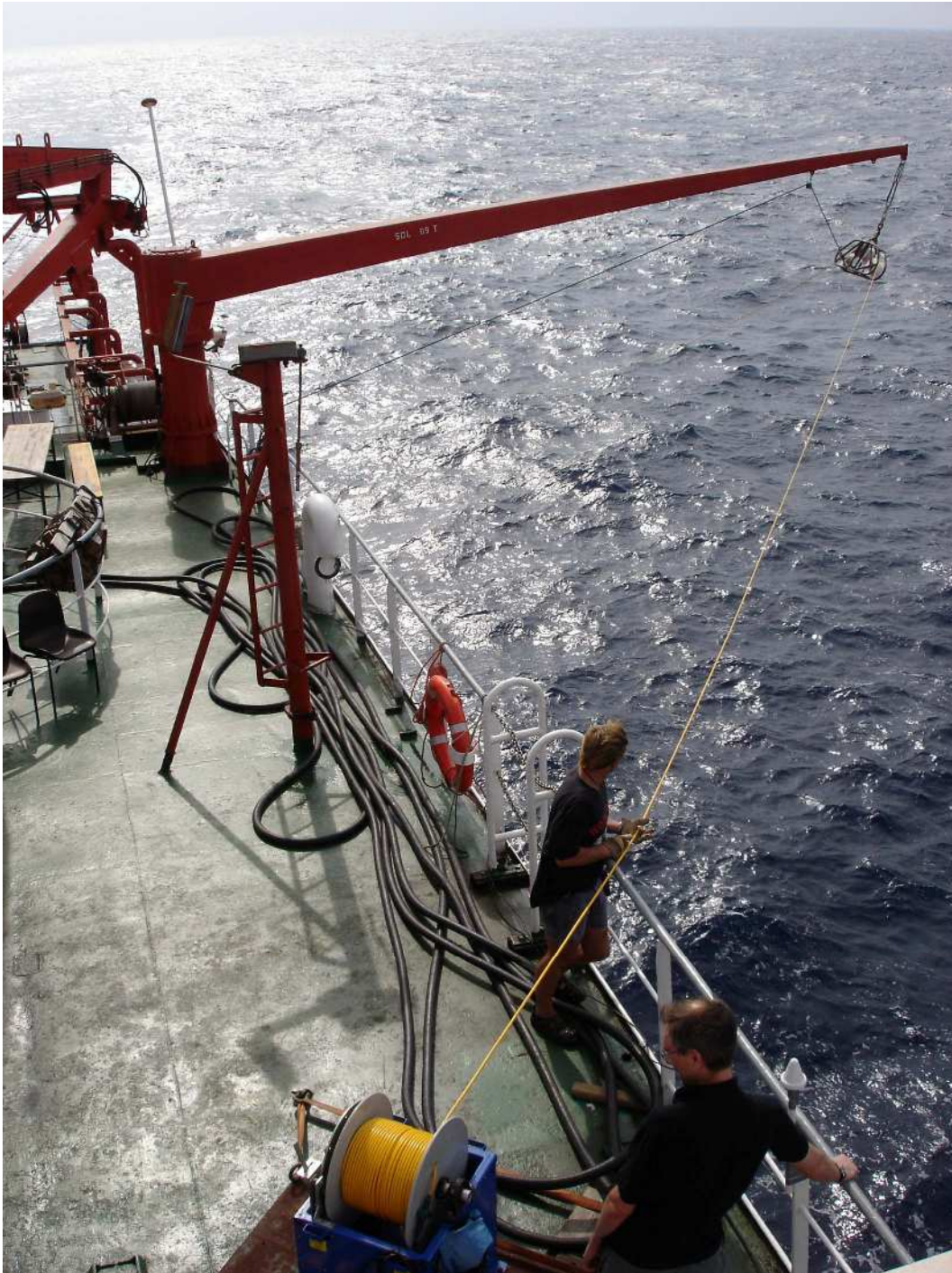

Figure 36: Magnetometer winch and deployment boom. The magnetometer is in the process of being deployed.

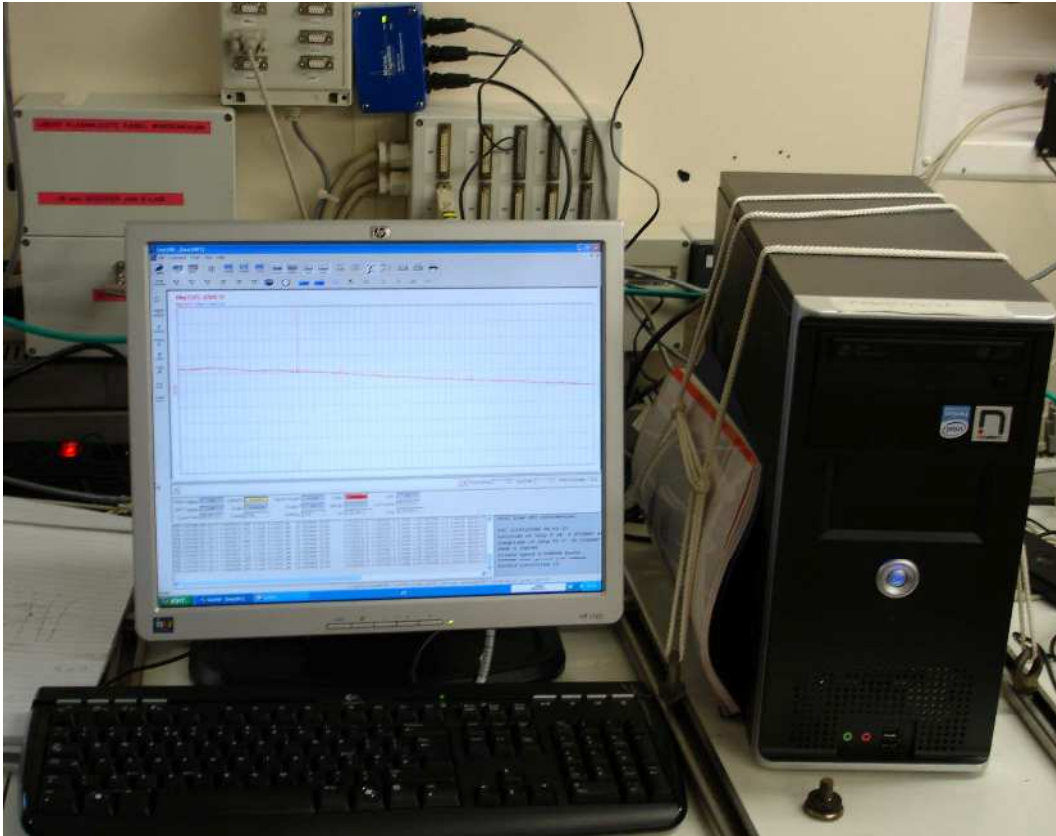

Figure 37: The magnetometer logging PC running *SeaLINK* software. The *Smart Transceiver* interface module is visible behind the monitor (blue box, centre top).

Data format

The *SeaLINK* software (version 8.00017) can record three output data streams; all are in ASCII text format:

1. *SeaLINK* raw data log (.mag)
2. XYZ data log (.XYZ)
3. NMEA log (.txt)

Since the NMEA log is a repeat of the GPS navigation stream, already logged in the Sonne's database, only the .mag and .XYZ files were recorded during SO198-1.

The .mag file contains all the possible data fields available, including any commands issued to the fish (Figure 38). Each record starts with a "*" then year (yy), Julian Day and time (hh:mm:ss.s), followed by each data values identified by prefix:

- F: field value (nT)
- S: field strength
- D: fish depth
- L: leak detector value
- Q: signal quality
- X: UTM Easting (m)
- Y: UTM Northing (m)

Z: UTM zone
 x: Longitude (decimal degrees)
 y: Latitude (decimal degrees)
 NOLBX/Y/Z/x/y: as X/Y/Z/x/y but with no layback correction
 <REAL> The co-ordinates for this data point recorded by the GPS
 <INTERP> The co-ordinate for this point was interpolated by software – GPS sampling rate is less than the instrument sampling rate
 <LAYBACK INTERPOLATION> Layback calculation has started – treat fish positions with caution!

```

*08.135/03:00:47.5 F:041892.453 S:153 D:+317.7m L0 0465ms Q:99
X:172248.3 Y:406668.6 Z:47N x:96.049854 y:3.674312 NOLBX:171948.4
NOLBY:406675.2 NOLBZ:47N NOLBx:96.047157 NOLBy:3.674363 <REAL>
*08.135/03:00:48.5 F:041892.432 S:151 D:+311.4m L0 0465ms Q:99
X:825640.2 Y:392168.0 Z:46N x:95.930737 y:3.543362 NOLBX:825940.2
NOLBY:392161.3 NOLBZ:46N NOLBx:95.933433 NOLBy:3.543293 <INTERP>
*08.135/03:00:49.5 F:041892.528 S:153 D:+311.4m L0 0465ms Q:99
X:172245.9 Y:406664.7 Z:47N x:96.049832 y:3.674277 NOLBX:171945.9
NOLBY:406671.4 NOLBZ:47N NOLBx:96.047135 NOLBy:3.674328 <REAL>
  
```

Figure 38: Three lines from an example SeaLINK raw data log (.mag) file.

The .XYZ file contains a 6-line header detailing the date and time at which the log started, where the log was recorded, and gives the title headings for all subsequent columns of data. This file is basically a simplified version of the .mag file, with minimal formatting for importing into another program. The locations recorded in this file are only those with a layback correction applied.

```

/ -----
/ Marine Magnetics Corp. SeaLINK Magnetometer Data Log [ 2008/05/14
03:00:47.5 ]
/ Filename -- [ C:\so198-1\sl_info_so198_1_002.XYZ ]
/ -----
/
/Date   Time   Field_Mag1  Alt_Mag1   Depth_Mag1  Longitude  Latitude
UTM_Easting UTM_Northing UTM_Zone
2008/05/14 03:00:47.5 41892.453 0.00m 317.7m 96.049854 3.674312
172248.3 406668.6 47N
2008/05/14 03:00:48.5 41892.434 0.00m 311.4m 95.930737 3.543362
825640.2 392168.0 46N
2008/05/14 03:00:49.5 41892.527 0.00m 311.4m 96.049832 3.674277
172245.9 406664.7 47N
  
```

Figure 39: The header and first three lines from an example .XYZ data log file.

Layback correction

The SeaLINK software, when a GPS navigation input is available, can automatically calculate a layback correction to the position logged with each field measurement to account for the distance offset between the GPS

antenna and the fish. This option was enabled during SO198-1, using a value of 300 m. Both antenna and layback-corrected positions are recorded in the .mag files.

Operational issues with the SeaSPY system

A number of issues were identified with the *SeaSPY* system, mainly with the *SeaLINK* software, that seriously affected its functionality.

1. It proved impossible to sync the fish/transceiver clock with either GPS or the PC clock.
2. Manually setting the time on the fish/transceiver clock requires the current date to be supplied in YYMMDD format yet returns a confirmation date in Julian Day which is one less than the true value. Since only the *SeaLINK* software logs the Julian Day, when manually setting the time the following days date must be entered.
3. A time delay occurs (~2x per day) in the GPS NMEA data stream displayed in the *SeaLINK* software resulting in the navigation time tags to lag behind the fish time tags. Once the lag reaches ~20 seconds GPS positions are no longer appended to either the .mag or .XYZ log files. Independently viewing the incoming NMEA data stream confirms that the lag originates within the logging PC.
4. The depth sensor on the fish must be calibrated on deck by zeroing the pressure sensor. The calibration is lost when power is removed from the fish. Due to the design of the winch, the fish must be disconnected from the power in order to be deployed. Without calibration the depth sensor calculates a fish depth of ~350 m, when it should not exceed 30 m (see earlier).

The NMEA data stream delay was suspected to be the result of using an RS232-to-USB adapter. Only a single conventional RS232 socket was available on the *SeaSPY* PC and this was occupied with the connection to the *Smart Transceiver*.

The Julian Day date and time synchronisation issues are probably related – the time can only be set correctly by supplying the wrong date and the automatic sync methods probably check that the Julian Day returned by the sync operation actually matches the real date. The fault is suspected to lie in the *Smart Transceiver* module software not accounting for 2008 as a leap year.

Results: Prologue (15th – 27th June)

The basic objectives, after transit from Merak, were as follows:

1. Test the integration of the NMF and ship's compressors, and determine the shortest shooting interval possible with the full airgun array at 150 bar (2000 psi).
2. Shoot airgun profiles over the long-term ocean-bottom seismometer (OBS) instruments deployed during SO198-1.
3. Acquire swath data over the incoming plate and seamounts west of Siberut Island.

During this period the swath bathymetry, sub-bottom profiler and gravity meter were operated continuously within the permitted survey area. When possible, the magnetometer was operated. XBT probes were deployed when the airguns were not being towed.

Survey narrative

Julian Day 167, Sunday 15th June

TH and LMcN arrive at ship. Various logistical issues have emerged from demobilising SO198-1 and mobilising SO198-2. The OBIC container from Singapore has not arrived and so 8 LASSI (OBS) instruments are still on board. The Master understands from the agent that the MCS streamer container is due in Jakarta on 20th June (Friday) but will not start clearance until 23rd June (Monday), a process expected to last 3 days.

SO198-1 party leave the ship after lunch. EEL (SP and MS) and NMF (WS and NS) engineers arrive at 14:00. Group travels to the hotel in Anyer at 16:00, where they meet the UTIG scientists (JA, SG and KM) and discuss options. DR arrives at hotel 22:00.

Julian Day 168, Monday 16th June

UK science party returned to ship 10:00. LASSI instruments offloaded from the ship, completing shipside demobilisation of SO198-1. Downloaded gravity data from SO198-1 – extremely slow process on the zip drive. Base station ties for Singapore and Merak worked up assuming that height above sea level recorded for the docks is the correct datum elevation compared with the established base stations. Instrument drift calculated as ~4 mGal during SO198-1.

Working plan is to sail 17th June (Julian Day 169) to do some work before the streamer arrives and then return to Merak. Reports received early afternoon that US group have been told to return to Jakarta to deal with some paperwork issues. Made contact with Yusuf (who had been in meetings all day) at 18:00 to be told that all scientists and technicians must meet at BPPT in Jakarta at 09:00 on 17th June with passports and photos. Master had to work hard to retrieve passports for those staying from SO198-1 from the immigration office in Merak.

Julian Day 169, Tuesday 17th June

Left ship 05:30 for Jakarta, arriving at BPPT 08:00. In morning did paperwork at BPPT/Ristek offices. In afternoon went to immigration office, where told different stamps/visas required in passports processed at all embassies except those processed at the Washington embassy. Passports retained by the immigration office, expected to be returned in 2-3 days. Given certified photocopies for any immediate requirements.

Returned to ship at 20:30 where the cook had left a good supply of food. Discussed paperwork issues with the Master, who believes that it will still be possible to sail provided all the party are happy to do so without passports.

Julian Day 170, Wednesday 18th June

Indonesian scientist (MS) and Security Officer (NS) arrive at ship 15:30. Start to clear immigration 16:00 and sail 18:30. Pass Krakatoa at approx 21:00, seeing eruptions with apparent lava plumes and flows; some are sufficiently explosive to be heard on the ship. Most of science party who had visited Jakarta had stomach problems overnight.

Julian Day 171, Thursday 19th June

In transit to the survey area, at times making over 13 kt speed over ground (SOG). There are 1-knot currents parallel to the course in favour during the day, and against overnight. Expect arrival at 2.5°S approximately 04:00, so scientific watch standing organised to start at that time.

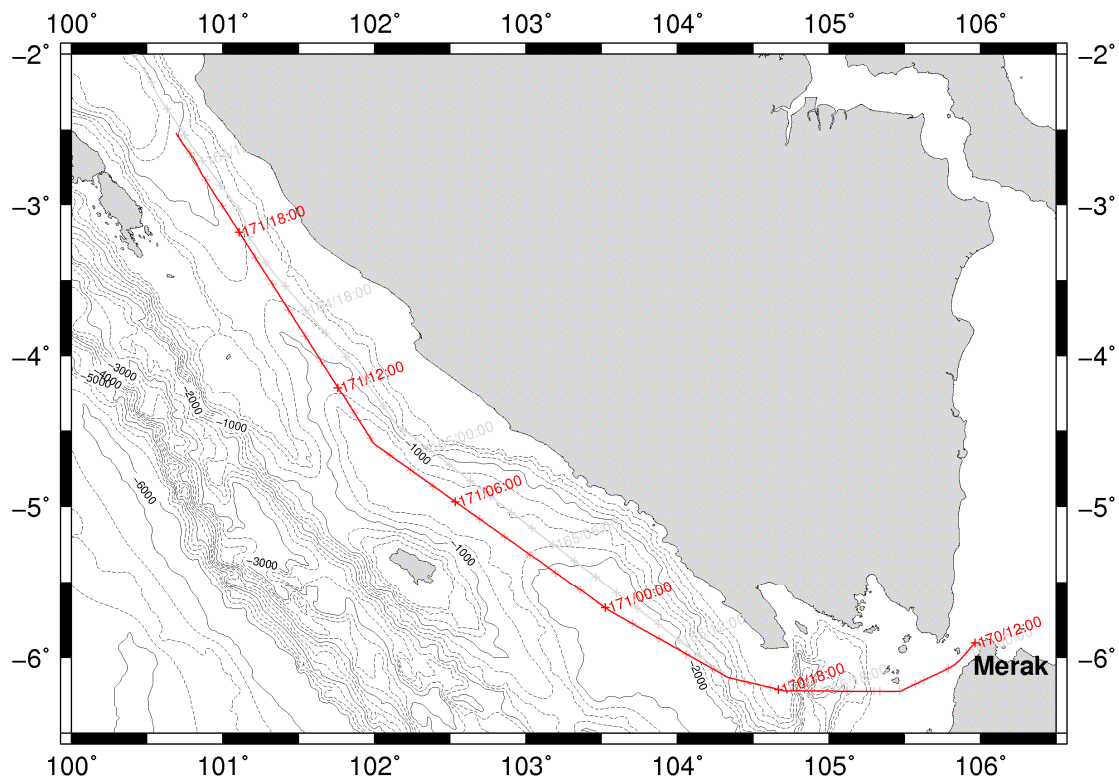

Figure 40: Map of the transit route taken from Merak to survey area for the first part of SO198-2. Crosses indicate the position each hour and every 6 hours is labelled with Julian Day and UTC time. GEBCO 1-minute bathymetry is contoured every 250 m.

Julian Day 172, Friday 20th June

Scientific watch standing started 04:00. Currents against progress again, so do not reach survey zone until 04:45, when EM120 and *Parasound* are switched on. Magnetometer deployed at 08:00, and transit continued at 12 kt to the south end of airgun-profile SUMCA (Figure 41). A number of fishing buoys are passed, as well as fishing vessels. In one instance a pod of dolphins are seen apparently raiding a fishing net. In the vicinity of south end of airgun-profile SUMCA at 15:00, magnetometer retrieved and airguns deployed. No marine mammals sighted, and array pressure and capacity ramped up to 135 bar (1958 psi) and 5420 cu.in. Some testing carried out on shot intervals suggesting that 20-second interval can be maintained with full array volume at 140 bar, but 15-second interval would require either decreasing volume or decreasing pressure to 125 bar. Start shooting at 60-second interval on 30.56 seconds after the GPS minute mark (as SO198-1) at 16:02 to calibrate the Siber-E1/2 long-deployment OBS as well as the land station on NE corner of Siberut Island itself. Array tuned in over the first hour, although numerous shot phones are not giving good signals. Passed long-deployment OBS site Siber-E1 at 18:29.

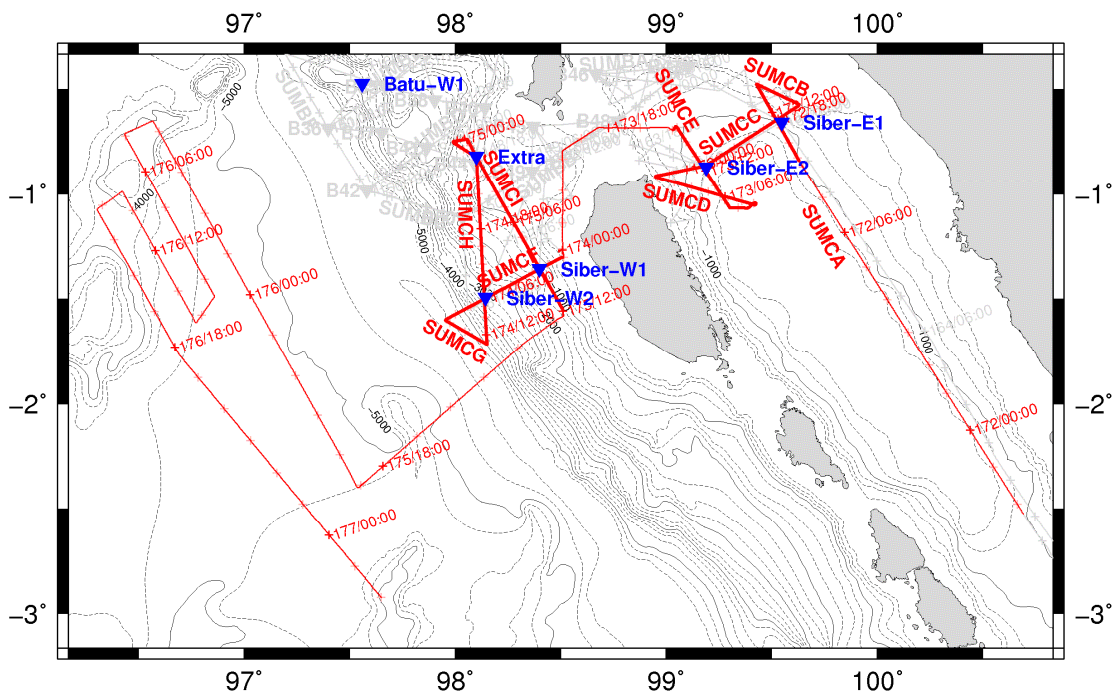

Figure 41: Map of survey tracks for the prologue to SO198-2. Crosses indicate the position each hour and every 6 hours is labelled with Julian Day and UTC time. Swath and *Parasound* data were acquired continuously; bold lines identify airgun profiles SUMCA-SUMCI. Blue triangles locate long-term ocean-bottom seismometers (OBS) deployed during SO198-1. GEBCO 1-minute bathymetry is contoured every 250 m.

Julian Day 173, Saturday 21st June

Continued shooting airguns at 60-second interval. Passed long deployment OBS Siber-E2 at 06:00. Very close inshore to Siberut Island during morning – weather wet rather than sunny. Reached end of survey for Siber-E1/2 OBS at 22:00, recovering the magnetometer as we approached the end point. Guns on board by 23:00 with a minor incident caused by a shackle failing on the port side during recovery. By the end of the survey, almost all shot phones

were working to some degree. Overnight travelled to the east end of airgun-profile SUMCF recording swath, gravity, and *Parasound* only.

Julian Day 174, Sunday 22nd June

Reached the east end of airgun-profile SUMCF, to the west of Siberut Island, at 06:00, when KS and DW checked the guns over. Started to redeploy guns at 06:45. Some problems with tangling of lines for the starboard side buoys, but guns still ready in an hour. Magnetometer redeployed. No marine mammals sighted, and array pressure and capacity was ramped up to 135 bar and 5420 cu.in. Started shooting at 20-second interval with the supplementary air from the compressor container. Few gun phones working. At 11:15 a leak was found in the container high-pressure air system, so the containerized compressors were taken out of circuit, and firing interval increased to 60-seconds. Long period but low amplitude swell from SSE; conditions still excellent. Air leak was due to failed 'O' ring on one of the compressor hoses, which was replaced during the afternoon. Passed long-term OBS site Siber-W1 at 09:30 and Siber-W2 at 06:00. Airgun shooting plan modified to incorporate a small survey around the long-term OBS site Extra.

Julian Day 175, Monday 23rd June

Continued airgun shooting, passing long-term OBS site Extra at 05:08 heading north and then looping around to head south again. Reduced shot interval to 20 seconds at 08:00 to test compressor repairs. With both NMF compressors running at full speed, there is slightly too much air, and the compressors cycle on and off. Configuration changed to run both compressors at half speed, which avoids this cycling; the pressure is reduced slightly from 137 bar to 133 bar. Airgun survey completed at the south end of profile SUMCI at 11:50 and guns recovered. Commenced swath, magnetics and gravity survey of incoming plate at 12:50. Ship's agent in Indonesia hopes that the streamer will be available 27th June (Julian Day 179) in Merak.

Julian Day 176, Tuesday 24th June

Continued swath, magnetics and gravity survey of the incoming plate. Survey designed to finish with the ship in south of the permit area at 08:00 25th June. Interesting inside corner high structures associated in some cases with 200-300 nT magnetic anomalies.

Julian Day 177, Wednesday 25th June

Leaving survey area southward. Reached southern end of the permit box at 09:00, and recovered the magnetometer and stopped swath and *Parasound* survey. Course to Merak passes site of GITEWS buoy (Figure 42), however no evidence of it is observed at the deployment location.

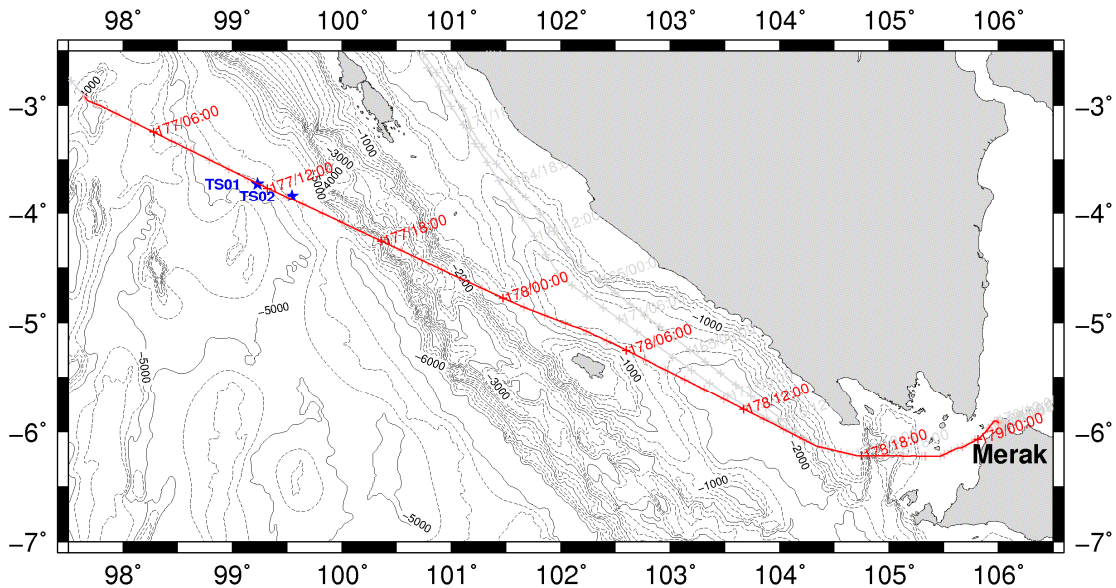

Figure 42: Map of the transit route taken from the survey area to Merak after the first part of SO198-2. Blue stars identify the location of GITEWS buoy(s). Crosses indicate the position each hour and every 6 hours is labelled with Julian Day and UTC time. GEBCO 1-minute bathymetry is contoured every 250 m.

Julian Day 178, Wednesday 26th June

Continue transit to Merak. News on streamer is not positive. Yusuf, the ship's agent and customs officials in discussions for much of day to try and devise a method by which it can be released by road.

Julian Day 179, Thursday 27th June

Berthed in Merak at 10:00. Ship joined by JB and three Indonesian scientists (HP, PD and AR). MCS streamer is still in customs.

Seismic source

Nine airgun profiles were shot during this period: SUMCA-SUMCE east of Siberut Island; SUMCF-SUMCI west of Siberut Island (Figure 41). The airguns were triggered at a 60 second interval for the first set of profiles. The shooting interval was reduced to 20 seconds for the second set of profiles until an air leak in the NMF compressor occurred. While repairs were being affected the shooting period was increased to 60 seconds. The shooting details are summarised in Table 11.

Start					End					Line
Julian Day	UTC Time	Shot No.	Lat.	Long.	Julian Day	UTC Time	Shot No.	Lat.	Long.	
172	08:50:30.56	0	-0.839	99.627	172	09:04:30.56	101	-0.822	99.618	Soft-start ~15s period
172	09:05:30.56	102	-0.821	99.617	172	13:48:30.56	385	-0.478	99.427	SUMCA Passed
172	11:29:30.56	246	-0.648	99.521						Siber-E1 Turn
172	13:49:30.56	386	-0.477	99.428						
172	13:50:30.56	387	-0.476	99.429	172	16:33:30.56	550	-0.574	99.629	SUMCB Turn
172	16:34:30.56	551	-0.575	99.629	172	16:35:30.56	552	-0.577	99.628	
172	16:36:30.56	553	-0.578	99.627	173	01:47:30.56	1104	-0.915	98.949	SUMCC Passed
172	17:45:30.56	622	-0.631	99.547						Siber-E1 Passed
172	02:54:30.56	931	-0.865	99.186						Siber-E2 Turn
173	01:48:30.56	1105	-0.916	98.948	173	01:51:30.56	1108	-0.918	98.948	
173	01:52:30.56	1109	-0.919	98.949	173	07:46:30.56	1463	-1.053	99.420	SUMCD Turn
173	07:47:30.56	1464	-1.052	99.422	173	09:30:30.56	1567	-1.065	99.299	
173	09:31:30.56	1568	-1.064	99.298	173	15:04:30.56	1901	-0.678	99.046	SUMCE Passed
173	12:16:30.56	1733	-0.871	99.172						Siber-E2 Soft-start ~20s period
174	01:02:10.56	0	-1.302	98.511	174	01:06:30.56	15	-1.302	98.505	
174	01:06:50.56	16	-1.302	98.505	174	04:30:10.56	626	-1.436	98.256	SUMCF 20s period Passed
174	02:33:50.56	277	-1.360	98.398						Siber-W1 Pressure loss identified
174	04:20:10.56	596	-1.430	98.268						
174	04:31:30.56	627	-1.437	98.254	174	08:37:30.56	873	-1.598	97.954	SUMCF Passed
174	06:03:30.56	719	-1.497	98.141						Siber-W2 Turn
174	08:38:30.56	874	-1.598	97.953	174	08:40:30.56	876	-1.601	97.953	
174	08:41:30.56	877	-1.602	97.953	174	11:24:30.56	1040	-1.715	98.147	SUMCG Turn
174	11:25:30.56	1041	-1.715	98.148	174	11:29:30.56	1045	-1.712	98.151	
174	11:30:30.56	1046	-1.711	98.151	174	22:07:30.56	1683	-0.825	98.100	SUMCH Passed Extra
174	22:07:30.56	1683	-0.825	98.100						
174	22:08:30.56	1684	-0.824	98.099	175	00:37:30.56	1833	-0.740	98.056	Turn
175	00:38:30.56	1834	-0.742	98.058	175	01:24:30.56	1880	-0.799	98.087	SUMCI SUMCI
175	01:25:30.56	1881	-0.800	98.087	175	11:49:50.56	3754	-1.550	98.508	20s period Passed Extra
175	01:45:30.56	1941	-0.825	98.100						
175	09:04:50.56	3259	-1.359	98.401						Passed Siber-W1

Table 11: The start and end time for each shooting profile versus shot number for the first part of SO198-2. Shooting interval is 60 seconds unless otherwise stated. Navigation locations are for the vessel, not the source.

Expendable bathythermograph data

A total of 7 XBT probes were deployed during the prologue to SO198-2 (Table 12; Figure 43). XBT Sequence number 103, a T5 probe, was launched while the airguns were deployed but failed after only 110 m, presumably because the data-return wire snagged on the airgun array. All other XBTs were launched when the airguns were not deployed. The XBT results (Figure 44) are very similar to those obtained by XBT, sound-velocity probe (SVP) and current-temperature-density probe (CTD) during SO198-1 (in Survey Box 2).

Sequence (deployment) number	Probe type	Latitude	Longitude	Approximate water depth (m)
102	T7	-1.27182	98.4896	356
103	T5	-1.34133	98.3909	110
104	T5	-1.58148	98.5107	1669
105	T5	-2.38687	97.5533	1490
106	T5	-0.657306	96.5503	3802
107	T5	-1.74034	96.6758	4469
108	T5	-2.94168	97.6614	3851

Table 12: Launch details for XBTs deployed during the prologue to SO198-2.

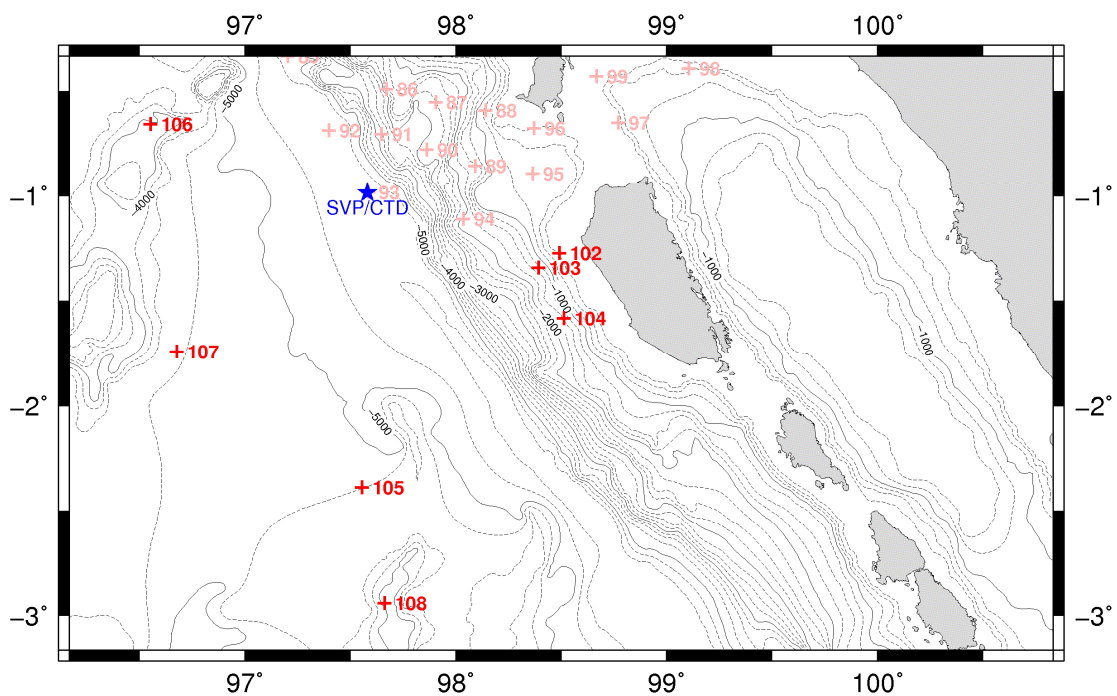

Figure 43: Location of the XBTs deployed during the prologue to SO198-2 (red crosses) and their Sequence number; faint red crosses identify XBTs deployed during SO198-1. The blue star shows the location of the nearest SVP/CTD deployment acquired during SO198-1.

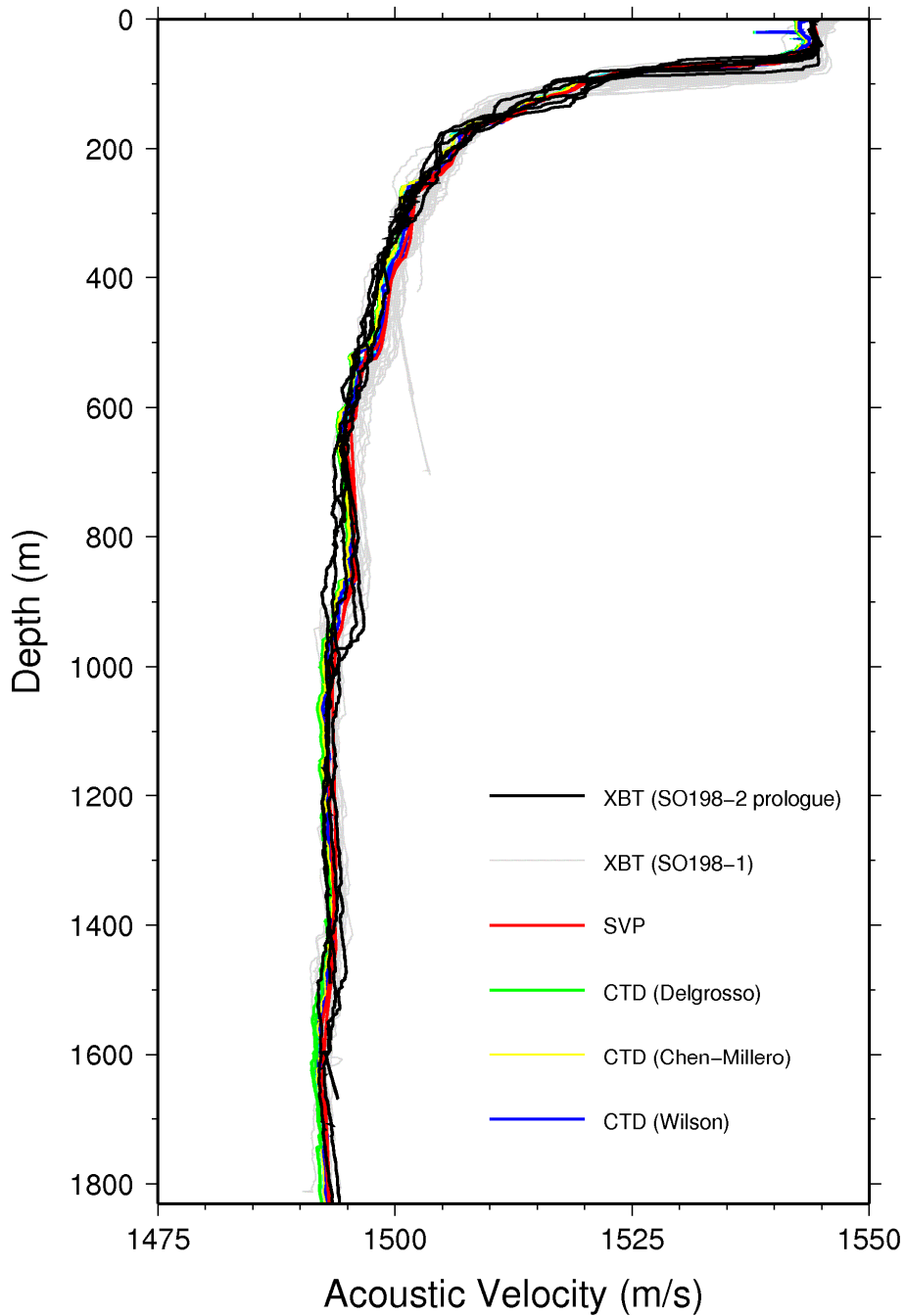

Figure 44: Acoustic velocity versus depth profiles obtained from all XBT probes launched during the prologue to SO198-2 (black lines). Also shown are the velocity values obtained during SO198-1 by XBT (grey), SVP (red) and CTD (green, yellow and blue).

Swath bathymetry

Swath bathymetric data were acquired continually within the designated survey area (Figure 45). The route into the survey area was offset a short distance to the west of the SO198-1 transit line to Merak.

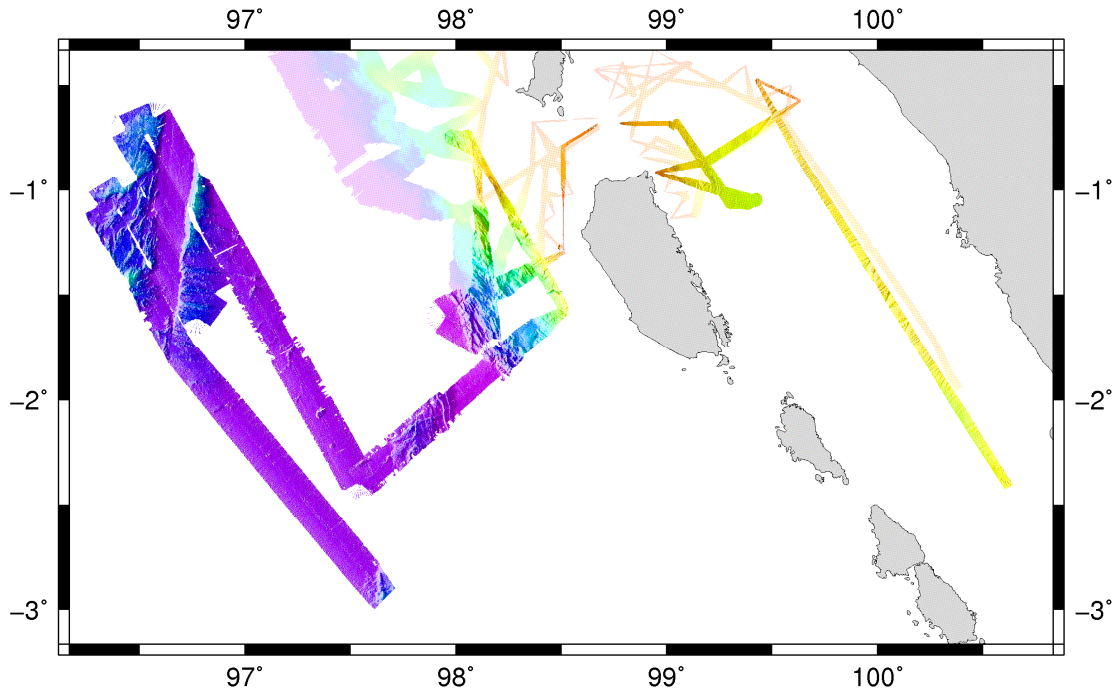

Figure 45: Raw swath bathymetric data acquired during the prologue to SO198-2. The data were gridded using Caris software. Illumination is from the south-west. Data from SO198-1 are shown in the background.

Parasound data

Parasound data were acquired continually within the designated survey area (Figure 46). Example sections of data are shown in Figure 47 and Figure 48.

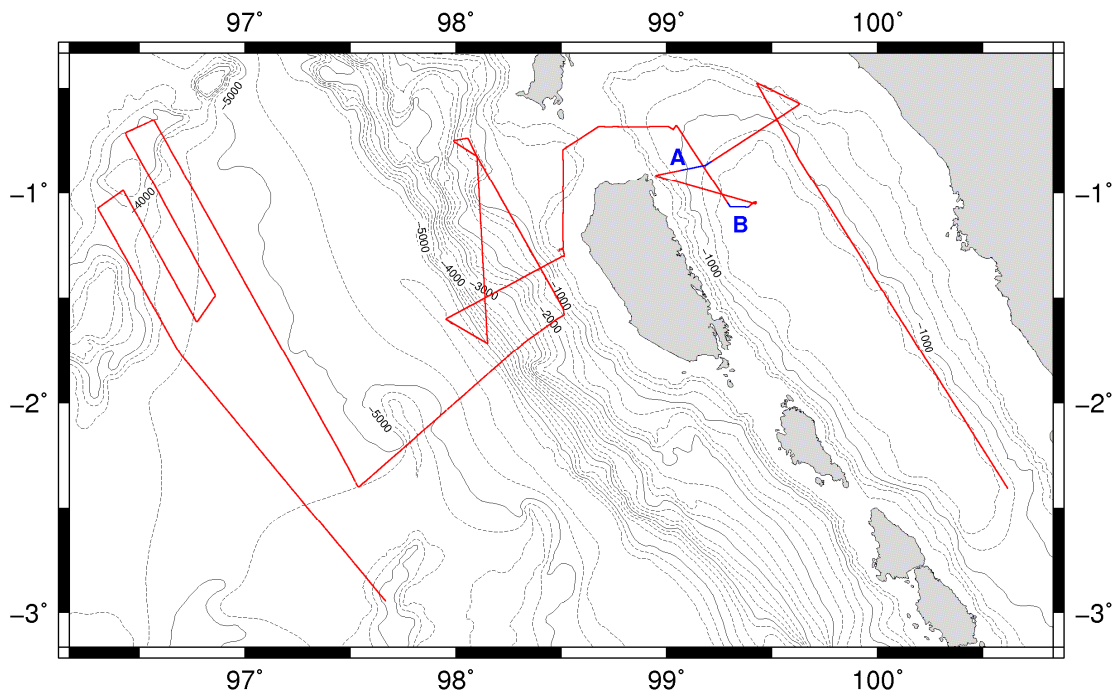

Figure 46: Location of the *Parasound* sub-bottom profiler data acquired during the prologue to SO198-2. Data along profiles labelled A and B are shown in Figure 47 and Figure 48 respectively.

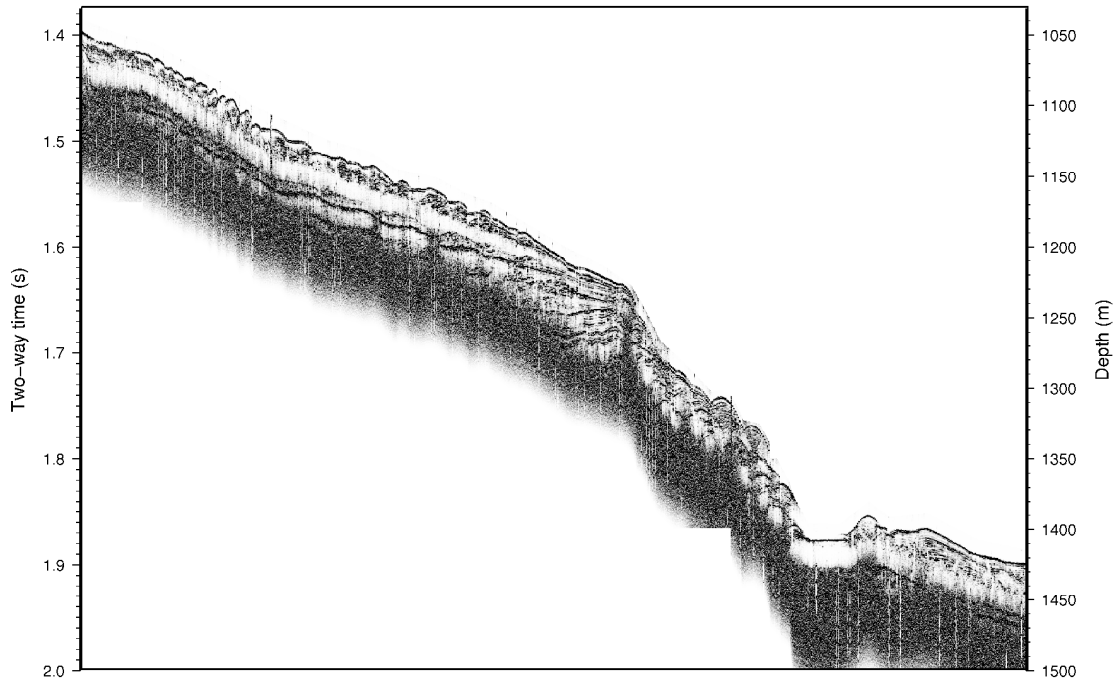

Figure 47: *Parasound* profile A (Figure 46), oriented WSW-ENE, acquired during the prologue to SO198-2. Note that the horizontal scale is dependent on the speed of the vessel. The total length of the profile is ~17.3 km; the vertical exaggeration is approximately x26.

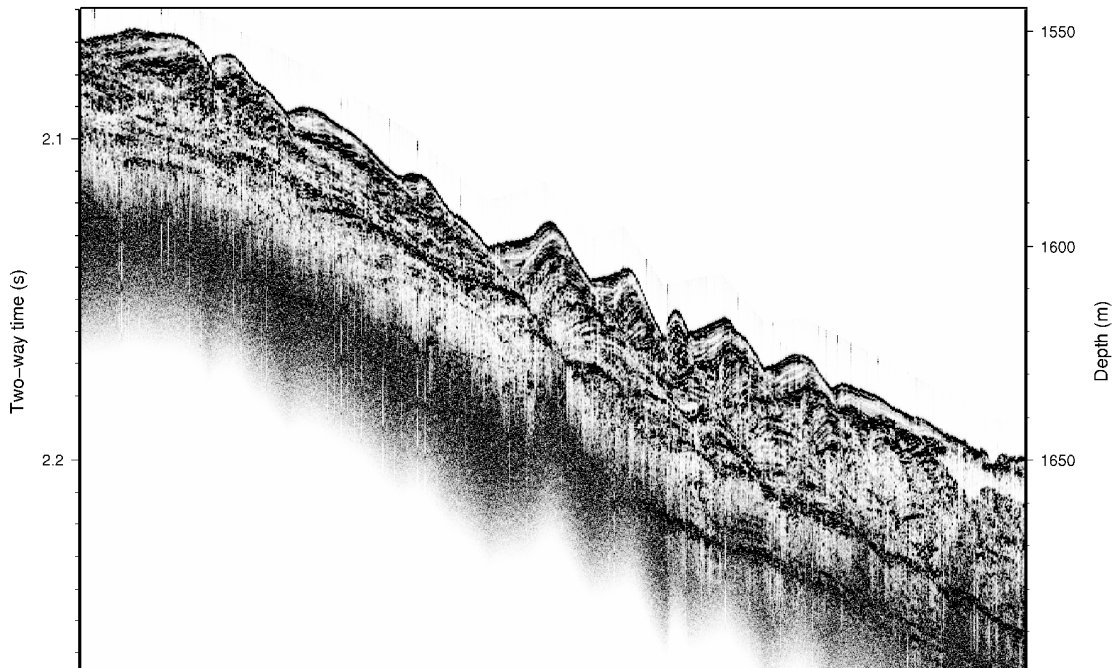

Figure 48: *Parasound* profile B (Figure 46), oriented WSW-ENE, acquired during the prologue to SO198-2. The total length of the profile is ~12.1 km; the vertical exaggeration is approximately x55.

Gravity data

Gravity data were acquired continuously to and from Merak, logged at 1-minute intervals on the laptop in the gravity meter room and at 1-second

intervals on the meter. The data from the meter were not downloaded upon return to Merak, although the gravity clock drift measurements continued.

Magnetic data

Magnetic data were acquired during airgun shooting and inside the designated survey area during the transit to and from Merak. No data were collected during the transit from the basin area east of Siberut Island to the trench because of the shallow (<50 m) water depths charted north of Siberut Island. The magnetometer was turned off and brought close to the ship during the recovery of the airguns on Julian Day 175, then redeployed prior to the swath and *Parasound* survey over the incoming plate. Data acquired are summarised in Table 13 and plotted in Figure 49.

File (.mag & .XYZ)	Start				End			
	Julian Day	UTC Time	Lat.	Long.	Julian Day	UTC Time	Lat.	Long.
sl_data_so198_2_000	172	01:34:49	-1.883	100.286	172	19:18:00	-0.701	99.439
sl_data_so198_2_001	172	19:18:01	-0.701	99.439	173	14:43:07	-0.701	99.061
sl_data_so198_2_002	174	01:28:42	-1.316	98.479	175	00:01:21	-0.745	98.010
sl_data_so198_2_003	175	00:01:22	-0.745	98.010	175	11:43:02	-1.545	98.505
sl_data_so198_2_004	175	12:51:38	-1.594	98.487	177	02:10:59	-2.945	97.664

Table 13: Details of the files of magnetics data acquired during the prologue to SO198-2.

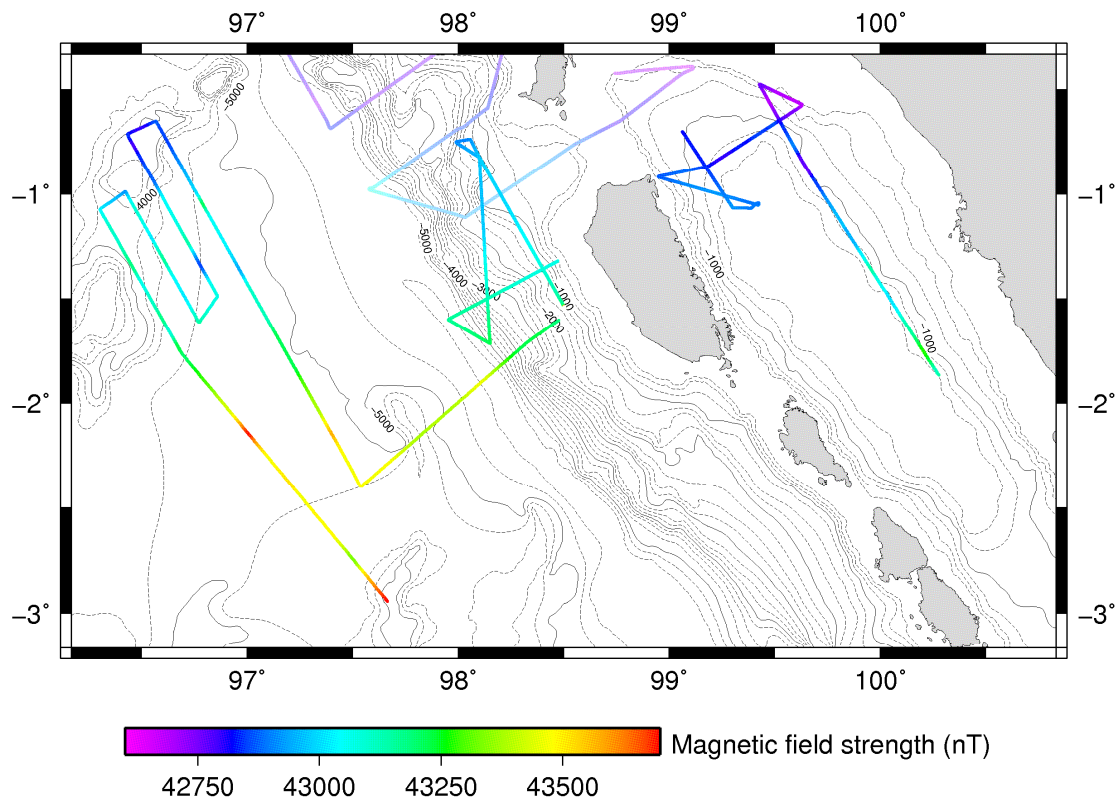

Figure 49: Magnetic field strength in nT measured during the prologue to SO198-2. Gaps in the data occur during transit north of Siberut Island and when the airguns were being recovered on Julian Day 175. The extra profiles toward the north of the figure are from SO198-2. GEBCO 1-minute bathymetry is contoured every 250 m.

Results: Survey Box 2 (28th June – 11th July)

The basic objective, after transit from Merak, was to shoot a series of multichannel seismic (MCS) profiles in Survey Box 2. During this period the swath bathymetry, sub-bottom profiler and gravity meter were operated continuously within the permitted survey area. When possible, the magnetometer was operated. XBT probes were deployed when the airguns were not being towed.

Survey narrative

Julian Day 180, Thursday 28th June

Alongside in Merak. MCS Streamer still progressing through customs process during the office hours of 08:00-12:00.

Julian Day 181, Thursday 29th June

Alongside in Merak. Sunday, so no progress on customs. Scientific party takes a road trip down the west coast of Java to look at some of the damage done by the 1883 Krakatoa tsunami. High humidity means it is too hazy to see Krakatoa itself.

Julian Day 182, Thursday 30th June

Alongside in Merak. Customs process restarts at 09:00. Assurances were received that the container would be on the road by 12:00. The agent is contacted hourly but no real news until 13:30, when word is received that the customs officers are going to the Agent's office. At 14:30 a message is received that the paperwork is complete, and that customs are starting to check the contents of the container. Around 18:00 a further message is received that process requires one more signature and stamp, from a customs officer who will be in at 08:00 in the morning.

Julian Day 183, Thursday 1st July

Alongside in Merak. No news throughout the morning on the customs issues. The agent is not answering his cell phone, Yusuf and Dayuf are away from the office. News is received around 12:00 that the agent is on his way to ship. The agent arrives at approximately 12:30 and reports that all the paperwork is complete, except for one signature and stamp from a customs officer who is at lunch. At around 13:30 news is received that the signature and stamp have been obtained, and that the container is on lorry, but waiting to be X-rayed, and will be delivered to the ship around 18:00. No further news is received until 18:45 when the agent reports that container has been X-rayed, and is now waiting for the customs escort to bring it to the ship. The lorry is expected to leave Jakarta around 19:00, and if so to arrive at ship at 23:00, with the ship sailing at approximately 01:00. The Merak crane drivers are apparently very happy to remain on hand. News is received at around 21:00 that the MCS streamer container has been delayed by several hours in heavy traffic, and is expected around 00:00.

Julian Day 184, Thursday 2nd July

The MCS streamer arrives at 01:15, and the container is removed from the lorry before final customs procedures and unloading. The ship provides several chains, strops and wires as well as a swivel for the lifting process that allow effective and speedy use of the container crane. The streamer winch is on board the ship at approximately 03:00, and the remaining items from the container are rapidly transferred. The equipment is secured and the ship leaves the dock at 04:40. Krakatoa is passed outbound at 08:15; visibility is only 2-3 km due to the high humidity. The transit continues to the forearc basin east of Siberut Island.

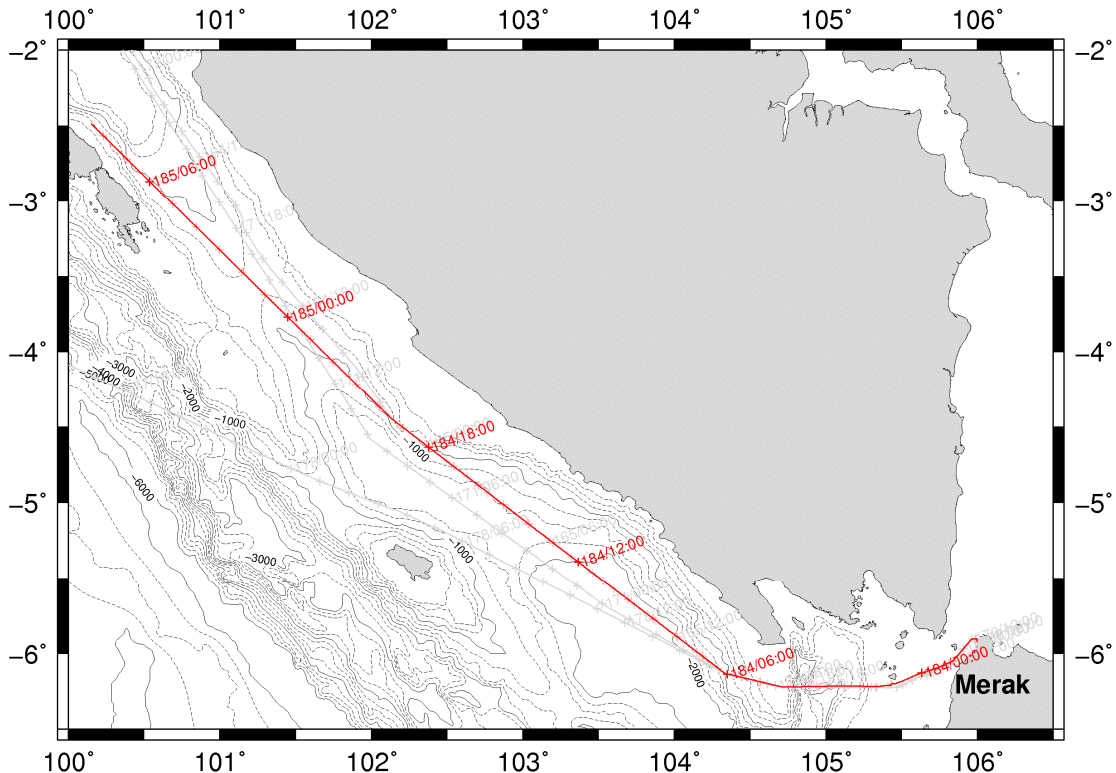

Figure 50: Map of the transit route taken from Merak to survey area for the second part of SO198-2. Crosses indicate the position each hour and every 6 hours is labelled with Julian Day and UTC time. GEBCO 1-minute bathymetry is contoured every 250 m.

Julian Day 185, Thursday 3rd July

Transit continues. The ship enters the permitted box at approximately 15:30, and the magnetometer is deployed. Swath and *Parasound* are turned on to record, and an XBT deployed. Waypoints are set to run along the west side of the forearc basin, to allow assessment of the presence of landslide structures that might pose a tsunami hazard for Padang.

Julian Day 186, Thursday 4th July

Transit continues until 05:30. The magnetometer is recovered, and the seismic gear is deployed. The streamer deployment starts at 06:40 and is complete at 08:09. A short period of testing follows to ensure that the streamer is towing level and to assess noise levels at 5 kt and 5.3 kt towing speeds. Gun deployment starts at 08:50 and is complete at 09:30. Each gun is test fired individually and the array is ramped up to full volume for the start

of SUMD01 at 10:40. At 13:35 the streamer stops communicating with the recording system requiring the DCXU, the interface box between the streamer and the acquisition unit in the laboratory, to be replaced. A loop is completed at 08:19, with the returning northeast leg designated SUMD01a, and the restarted southwest leg designated SUMD01b. Conditions inside the islands are ideal although a strong head current occurred when approaching the shallowest water together with fronts marked by severe short chop.

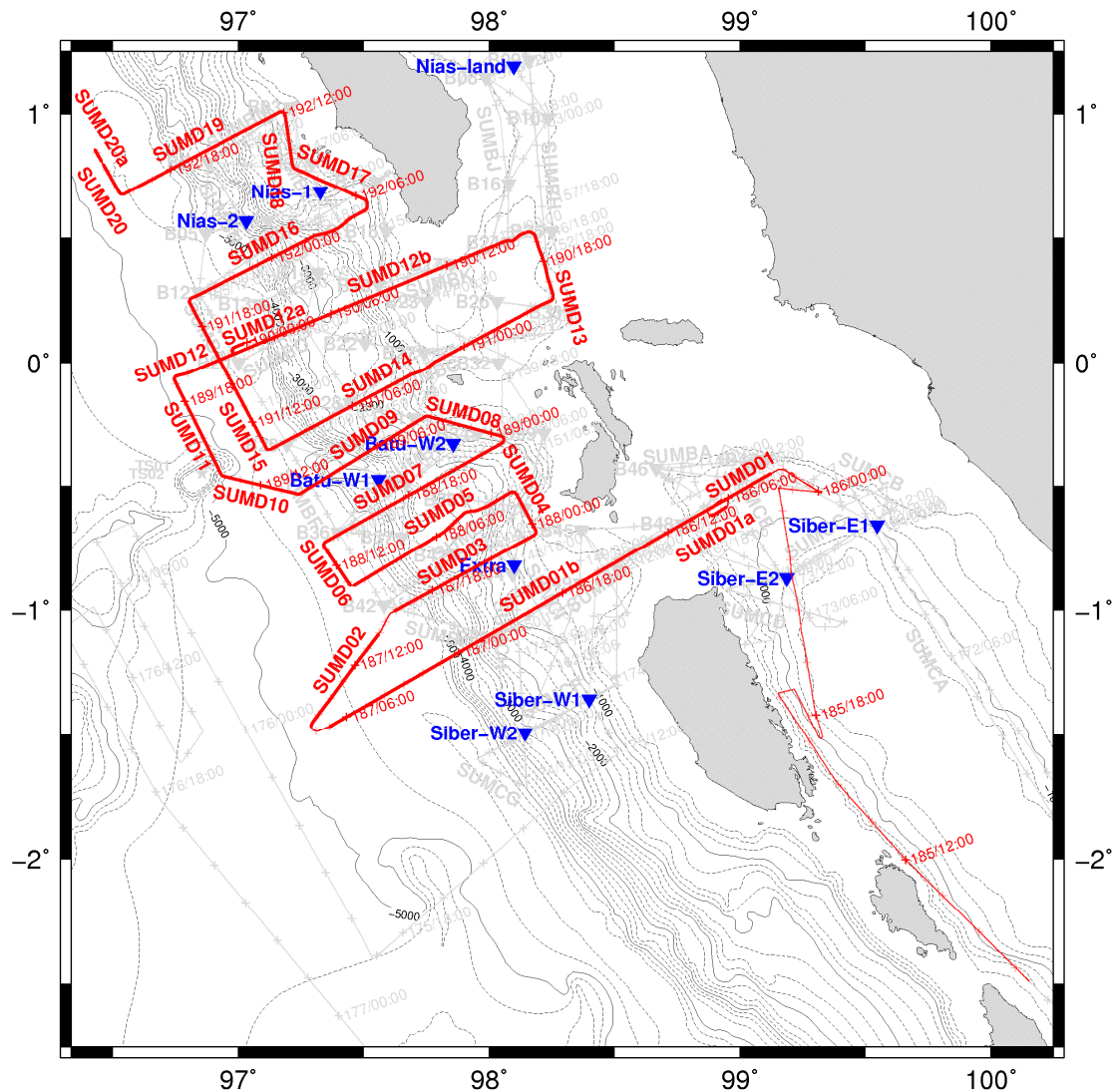

Figure 51: Map of survey tracks in Survey Box 2. Crosses indicate the position each hour and every 6 hours is labelled with Julian Day and UTC time. Swath and *Parasound* data were acquired continuously; bold lines identify multichannel seismic (MCS) profiles SUMD01-SUMD20a. Blue triangles locate long-term ocean-bottom seismometers (OBS) deployed during SO198-1. GEBCO 1-minute bathymetry is contoured every 250 m.

Julian Day 187, Thursday 5th July

The sea state builds from 03:00 and once in the open ocean there is a long period swell as well as persistent chop. The front section of the streamer is consistently shallow, and does not change depth when either decreasing speed (to reduce the overall tension and lift) or increasing speed (to allow the birds to work more effectively). The batteries in birds 1 and 2 exhausted

towards end of SUMD01b. SUMD01b is completed at 13:55 and the streamer is hauled in up to bird 2 to change the batteries; approx 2 kg of weight is added to the adapter section during redeployment. During the turn to SUMD02 some testing is done on the *Longshot* inputs to try and get the remaining shot signals working; this is partially successful. SUMD02 is relocated slightly to head straight for the original end of line. Chop and noise is still a problem during SUMD02; attempts are made to run the streamer at 10 m to see whether this will be below wave base, but are unsuccessful. The tail of the streamer runs at the requested depth, but the sections to bird 3 are consistently shallow. The decision is made to haul the streamer in to bird 3 and add more weight at end of SUMD02. On recovery, it is discovered that the first sections of the streamer have only plastic blanking on the weight collars; every other blank is replaced with a 700 g bronze weight (21 in total). A large shackle is also added to the middle of the stretch section (Figure 52). On redeployment the streamer responds much better to depth commands, with less wing angle needed at the front. SUMD03 is started immediately following the streamer servicing since we are still within the trench, and taken directly toward the original end of line.



Figure 52: The shackle attached to the middle of the streamer's stretch section.

Julian Day 188, Thursday 6th July

It is clear that sea conditions and line orientation significantly affect the noise on the data. A strong swell from the south has a big affect on the lines shot to the northwest. In the morning the speed is increased to try and bring the front

end of the streamer up; a better solution turns out to be to set the streamer at 10 m depth rather than 8 m; this is below much of the wave base and decreases the noise as well as requiring less angle on the birds. Line SUMD04 is completed at 08:42, SUMD05 at 17:40, and SUMD06 at 20:13. A barbecue is organised in the evening despite noise from the compressor container; it is the clearest night since leaving Merak.

Julian Day 189, Thursday 7th July

Overnight and during the morning there are thunderstorms with heavy rain and strong wind; numerous spikes on the magnetometer may be due to lightning strikes. Breakfast is unusually quiet. Line SUMD07 is completed at 06:08. At 09:40, one of the containerised compressors shows signs of oil pressure problems due to water in the system – a result of the cooling water being at 30°C when the ambient temperature is also high. The affected compressor is shutdown for preventative maintenance; the shot interval is increased to 21 s to maintain the gun pressure at over 130 bar. The compressor is back online at 11:33, and shot interval is decreased to 20 s. Line SUMD08 is completed at 10:05, SUMD09 at 17:08 and SUMD10 at 20:53. SUMD10 is oriented particularly badly relative to the long period swell from the south and has significant wave noise on the streamer; an attempt is made to increase the depth to 12 m, but while the rear of the streamer descends quickly, bird 1 remains at 10 m, and there is no improvement to the overall noise. The streamer is returned to 10 m depth.

Julian Day 190, Thursday 8th July

Continuation of the seismic reflection survey in Survey Box 2. Line SUMD11 is completed at 02:13 and the turn is made onto the next long cross-margin profile SUMD12. The equator is crossed northwards at 04:00. The swell is intermittently 3-4 m in amplitude, but on the northeast sailing direction the streamer noise is still low. At 05:53 a failure of the FTP system seems to lock up the entire acquisition software; a circle is initiated, while the recording system requires a hard reboot and then reconfiguration. Line SUMD12a starts during the turn at 07:11 and, following the circle, line SUMD12b resumes the original profile at 07:46, with the reinstalled “seagoing” workstation acting as the FTP server rather than “squirt”. Conditions are excellent for acquisition throughout remainder of the line. Brute stacks of lines SUMD03, SUMD05, SUMD07 and SUMD09 are completed. At 22:14, towards the end of line SUMD12b, unlit fishing gear is seen ahead but too close to avoid and the ship crosses a net or line. There are temporary increases in pull on the guns, magnetometer, and eventually the streamer. Bird 9 shows a persistent depth of 8 m despite using maximum downward wing angle, however no additional noise is seen on the streamer. The decision is taken to investigate with the workboat after breakfast.

Julian Day 191, Thursday 9th July

Continuation of the seismic reflection survey in Survey Box 2. Line SUMD13 is completed at 02:40. The rear of the streamer is brought to the surface and the workboat conducts a survey at 08:00; there is no sign of damage to, or problems with, the birds to explain the observed behaviour, but bird 9 runs persistently shallow throughout the day. Line SUMD14 is completed at 17:40.

The swell in the open ocean is less pronounced than for several days. The rate of processing of seismic data exceeds acquisition and the backlog of brute stacks is reducing.

Julian Day 192, Thursday 10th July

Continuation of the seismic reflection survey in Survey Box 2. Line SUMD15 is completed at 02:27. Bird 9 starts to run deeper overnight, and remains stable through the day. Much of day is spent skirting the islands off the coast of Nias; there is much activity on the mobile phones. Line SUMD16 is completed at 11:53, SUMD17 at 16:17, and SUMD18 at 18:49. The swell is almost imperceptible by the evening, and following a day of mostly sunshine, there is mixed cloud cover at sunset.

Julian Day 193, Thursday 11th July

Continuation of the seismic reflection survey in Survey Box 2, and the start of data collection northward into Survey Box 1. Line SUMD19 is continued until 03:29 then turn to head north-northwest with the line designated SUMD20. The failure of a valve on the ship's compressor at 05:18 requires shooting to stop and the alternate compressor to be started. Shooting restarts at 05:30 with the line designated as SUMD20a. The magnetometer is recovered at 06:00 followed by front part of the streamer to investigate why the depth of bird 1 dropped to 6 m overnight. Batteries are replaced in bird 1, and the streamer is paid out again. Since the front of the streamer is still running very shallow, the streamer is recovered once more as far as bird 1 and approximately 5 kg of weight is added (Figure 53). Bird 1 continues to run shallow despite the growing collection of ironmongery; an additional 10 m of lead-in is run out (increasing the near offset to 110 m), which also has a limited effect once we gain speed. Start of data acquisition in Survey Box 1.



Figure 53: Additional weight being added to the streamer.

Seismic source

Start			End			Shot Int. (s)	Line/comment
Julian Day	UTC Time	Longshot No.	Julian Day	UTC Time	Longshot No.		
186	03:40:30	2	186	06:37:50	534	20	SUMD01
186	05:20:30	302				20	Pressure 127 bars
186	05:45:30	377				20	Pressure 135 bars, compressor 1 increased to max.
186	06:44:10	553				20	Intermittent signal from streamer
186	07:31:10	694	186	08:18:50	837	20	SUMD01a
187	08:57:30	953	187	06:55:50	4908	20	SUMD01b
187	07:50:10	4907					Testing guns
187	08:18:50	5002	187	13:50:30	5997	20	SUMD02
187	13:58:10	6020				20	Guns off, weighting streamer
187	15:55:10	6089	187	23:24:50	7438	20	SUMD03
187	23:27:30	7446	188	01:42:50	7852	20	SUMD04
188	01:46:50	7864	188	10:35:50	9451	20	SUMD05
188	10:48:50	9490	188	13:12:30	9921	20	SUMD06
188	13:17:30	9936	188	23:08:30	11709	20	SUMD07
188	13:23:10	9953				20	Gun 12 to manual
188	14:40:30	10185				20	Gun 4 off and on again
188	23:11:50	11719	189	03:06:30	12423	20	SUMD08
189	02:40:30	12345				20	1 compressor shut down (oil leak)
189	02:54:50	12388				20	Pressure 125 bars
189	03:11:50	12439	189	10:09:10	13679	20, 21	SUMD09
189	03:12:30	12441				21	
189	04:17:10	12623				20	
189	04:33:10	12671				20	2 compressors working
189	10:11:50	13687	189	13:51:30	14346	20	SUMD10
189	13:58:10	14366	189	19:12:10	15308	20	SUMD11
189	19:13:50	15313				20	SUMD12
189	22:43:10	15941				20	Streamer system crash
190	00:11:50	16207		00:42:10	16298	20	SUMD12a
190	00:44:50	16306	190	16:12:10	19088	20	SUMD12b
190	15:14:10	18914				20	Course change, sail through fishing nets
190	15:25:30	18948				20	Problem with Gun 4
190	16:16:30	19101	190	19:38:10	19706	20	SUMD13
190	19:40:10	19712	191	10:10:10	22322	20	SUMD14
191	10:14:50	22336	191	19:27:10	23993	20	SUMD15
191	19:28:50	23998	192	04:51:10	25685	20	SUMD16
191	04:53:30	25692	192	09:13:50	26473	20	SUMD17
192	09:17:10	26483	192	11:49:30	26940	20	SUMD18
192	11:53:10	26951	192	20:29:10	28499	20	SUMD19
192	20:29:50	28501	192	22:18:30	28827	20	SUMD20
192	22:18:30	28827				20	Guns off, compressor problem
192	22:31:30	28831	192	23:11:30	28951	20	SUMD20a; swapped ship's compressors

Table 14: Log of the airgun shooting interval and *LongShot* number versus the start and end times for each MCS line, as recorded by the watch keeper.

Multichannel seismic reflection data

Figure 54: Shot point (FFID) map for multichannel seismic (MCS) profiles SUMD01-SUMD20a in Survey Box 2. Black crosses identify every 500 FFIDs. Blue triangles locate long-term ocean-bottom seismometers (OBS) deployed during SO198-1. GEBCO 1-minute bathymetry is contoured every 250 m.

Line	Start					End				
	Julian Day	Sercel Time	FFID No.	Lat.	Long.	Julian Day	Sercel Time	FFID No.	Lat.	Long.
SUMD01	186	03:40:03	1	-0.451	99.121	186	06:39:10	533	-0.575	98.906
SUMD01a	186	07:30:50	542	-0.619	98.888	186	08:18:30	685	-0.584	98.945
SUMD01b	186	08:57:10	686	-0.557	98.927	187	06:55:10	4638	-1.468	97.365
SUMD02	187	08:18:30	5000	-1.468	97.291	187	13:50:09	5995	-1.098	97.557
SUMD03	187	15:54:50	6000	-1.004	97.624	187	23:22:30	7343	-0.698	98.179
SUMD04	187	23:27:09	8000	-0.694	98.183	188	01:42:10	8405	-0.525	98.100
SUMD05	188	01:46:29	9000	-0.524	98.094	188	10:35:29	10587	-0.901	97.461
SUMD06	188	10:48:29	11000	-0.900	97.445	188	13:12:09	11431	-0.744	97.341
SUMD07	188	13:16:49	12000	-0.739	97.340	188	23:07:49	13773	-0.323	98.054
SUMD08	188	23:11:29	14000	-0.319	98.057	189	03:06:09	14704	-0.219	97.759
SUMD09	189	03:11:29	15000	-0.218	97.752	189	10:08:49	16240	-0.532	97.244
SUMD10	189	10:11:28	17000	-0.532	97.240	189	13:51:09	17659	-0.459	96.938

SUMD11	189	13:57:50	18000	-0.454	96.931	189	19:11:50	18935	-0.073	96.745
SUMD12	189	19:13:30	19000	-0.071	96.744	189	22:42:30	19627	0.049	97.019
SUMD12a	190	00:11:30	20000	0.075	97.019	190	00:41:50	20091	0.058	96.980
SUMD12b	190	00:44:30	21000	0.055	96.977	190	16:11:50	23782	0.521	98.145
SUMD13	190	16:16:10	24000	0.523	98.151	190	19:37:50	24605	0.269	98.255
SUMD14	190	19:39:49	25000	0.266	98.255	191	10:09:49	27610	-0.351	97.131
SUMD15	191	10:14:29	28000	-0.353	97.125	191	19:26:49	29657	0.239	96.806
SUMD16	191	19:28:29	30000	0.241	96.805	192	04:50:49	31687	0.607	97.498
SUMD17	192	04:53:09	32000	0.608	97.501	192	09:13:29	32781	0.780	97.224
SUMD18	192	09:16:49	33000	0.783	97.221	192	11:49:09	33457	0.992	97.187
SUMD19	192	11:52:49	34000	0.997	97.186	192	20:28:48	35548	0.677	96.546
SUMD20	192	20:29:28	36000	0.677	96.545	192	22:18:08	36326	0.794	96.462
SUMD20a	192	22:31:08	37000	0.810	96.453	192	23:11:09	37120	0.854	96.428

Table 15: Start and end times, FFID numbers and locations for multichannel seismic (MCS) lines SUMD01-SUMD20a in Survey Box 2. Times are extracted from the SEG-D headers and represent the system time on the Sercel, not UTC, although the clock was synchronised to UTC at the start of the experiment and is therefore correct to seconds.

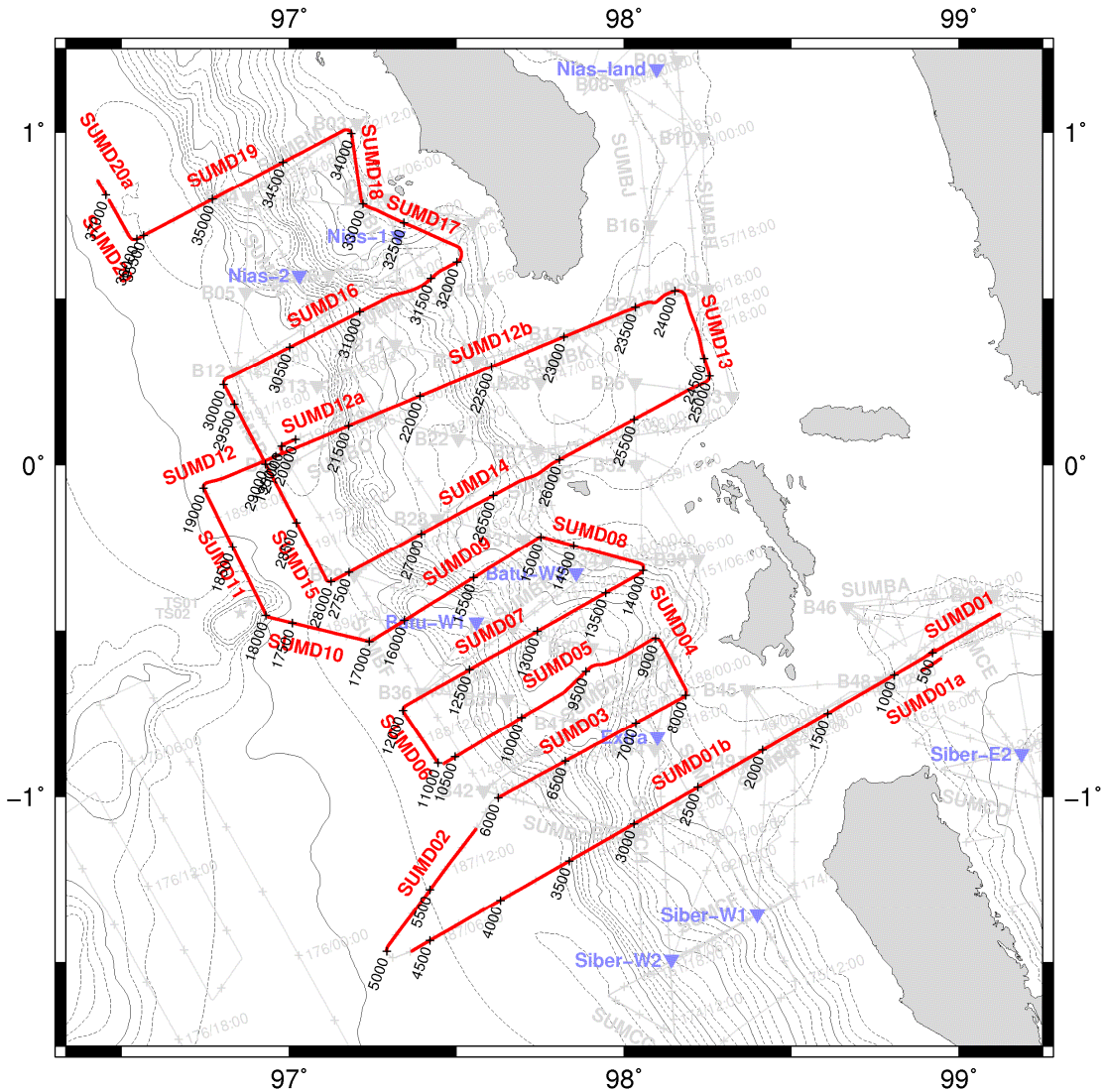
Start		End		Depth	Comments
Julian Day	UTC Time	Julian Day	UTC Time		
186	03:40	187	09:25	8	Streamer depth not noted until 186/12:20; computer crash at 186/06:34
187	09:25	187	10:11	10	Target depth changed due to noise
187	10:11	188	01:20	8	Front of streamer resistant to change to 10 m depth
188	01:20	188	13:12	10	
188	13:12	188	21:40	10	Bird 1 consistently <8 m until 188/21:40
188	21:40	189	11:18	10	Compressor failure at 189/02:42, reduced pressure until 189/03:06
189	11:18	189	11:39	12	
189	11:39	191	10:10	10	6 shots not recorded between 189/13:58 & 14:10. Streamer error at 189/22:57; inspection of streamer at 191/01:00-01:46 after tension spike noticed at 190/17:00; nothing found
191	10:10	191	19:27	10	Bird 1 consistently shallow (<8 m)
191	19:27	192	04:51	10	
192	04:51	192	11:49	10	Bird 1 consistently shallow (<8 m)
192	11:49	192	20:29	10	
192	20:29	192	23:11	10	Problem with ship's compressors at 192/22:12; Bird 1 consistently at 5.5-7.5 m

Table 16: Log of the streamer depth, set by command to the depth control birds, during the acquisition of MCS (MCS) lines SUMD01-SUMD20a in Survey Box 2.

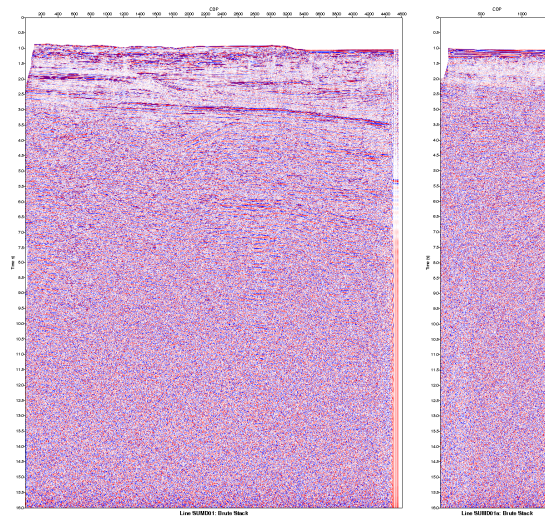

Figure 55: Stacked multichannel seismic sections for profile SUMD01 (left) and SUMD01a (right).

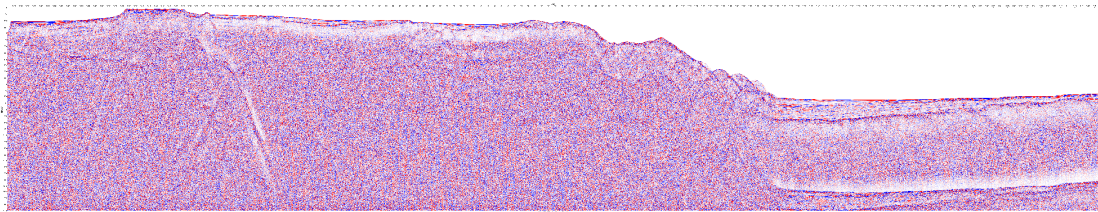

Figure 56: Stacked multichannel seismic section for profile SUMD01b.

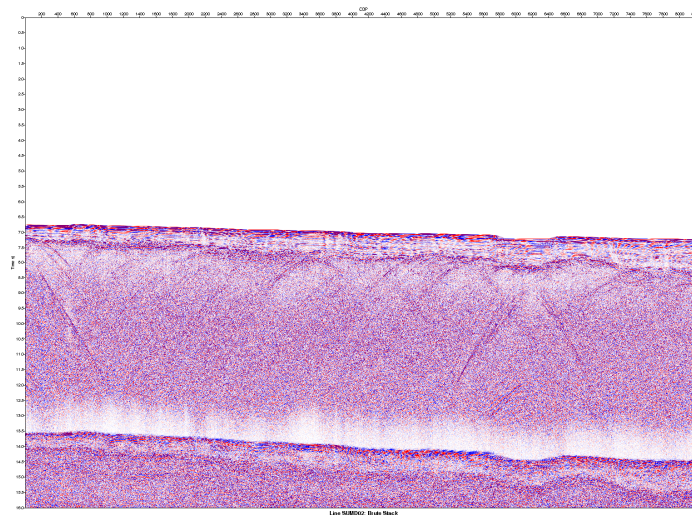

Figure 57: Stacked multichannel seismic section for profile SUMD02.

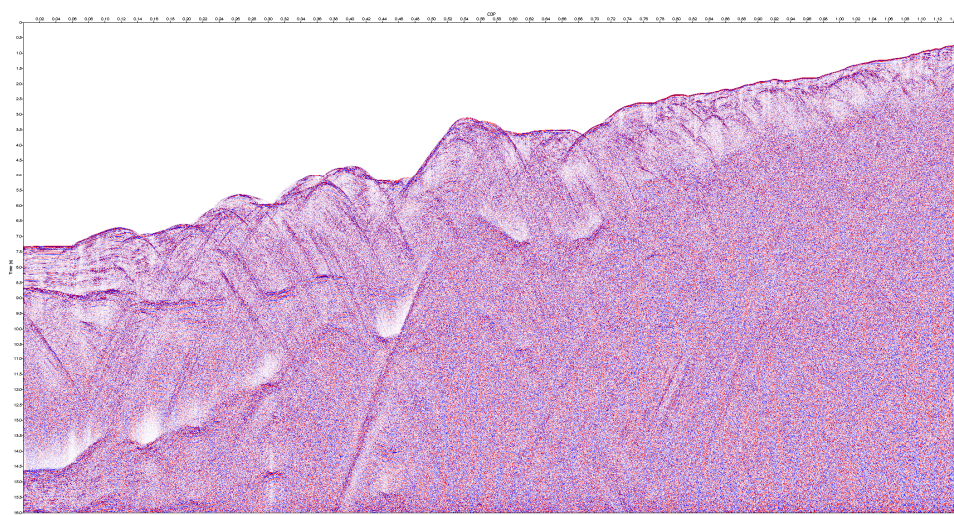

Figure 58: Stacked multichannel seismic section for profile SUMD03.

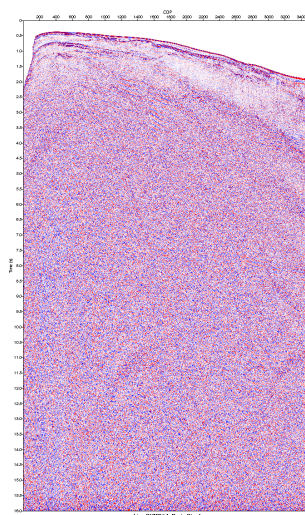

Figure 59: Stacked multichannel seismic section for profile SUMD04.

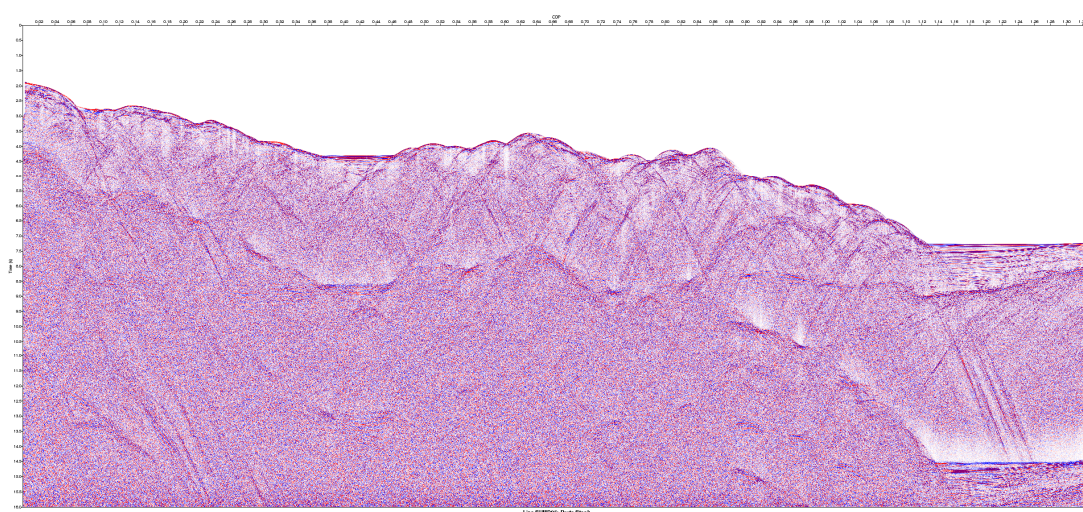

Figure 60: Stacked multichannel seismic section for profile SUMD05.

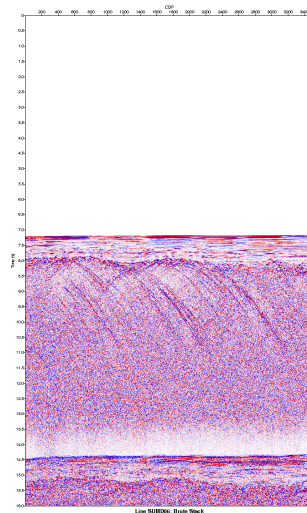

Figure 61: Stacked multichannel seismic section for profile SUMD06.

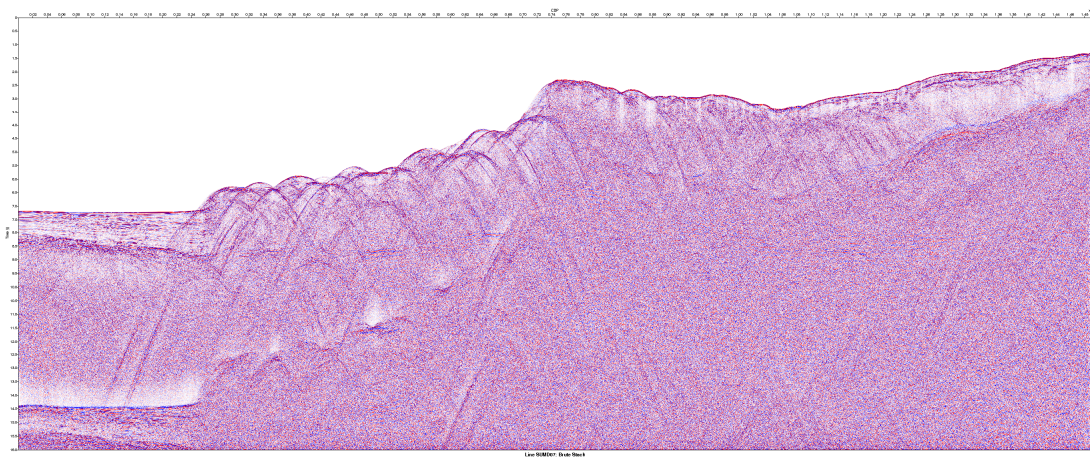

Figure 62: Stacked multichannel seismic section for profile SUMD07.

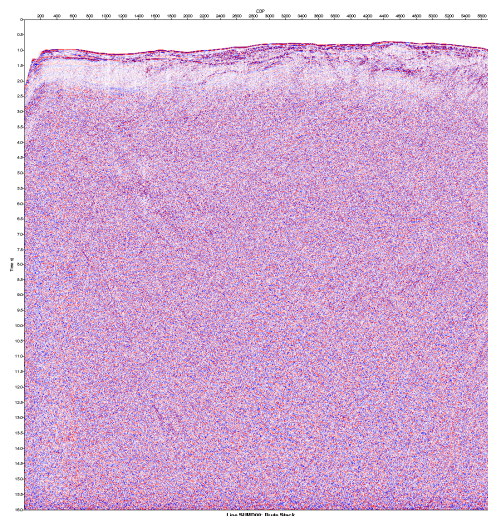

Figure 63: Stacked multichannel seismic section for profile SUMD08.

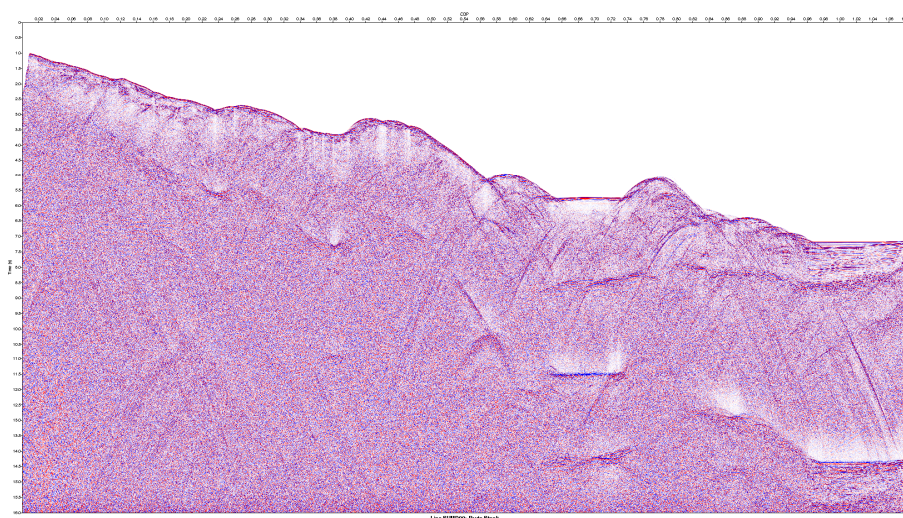

Figure 64: Stacked multichannel seismic section for profile SUMD09.

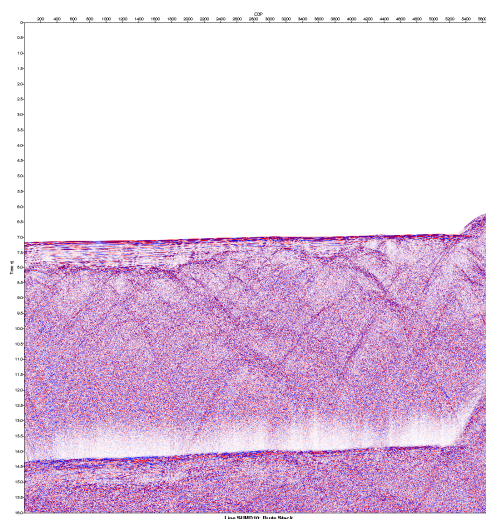

Figure 65: Stacked multichannel seismic section for profile SUMD10.

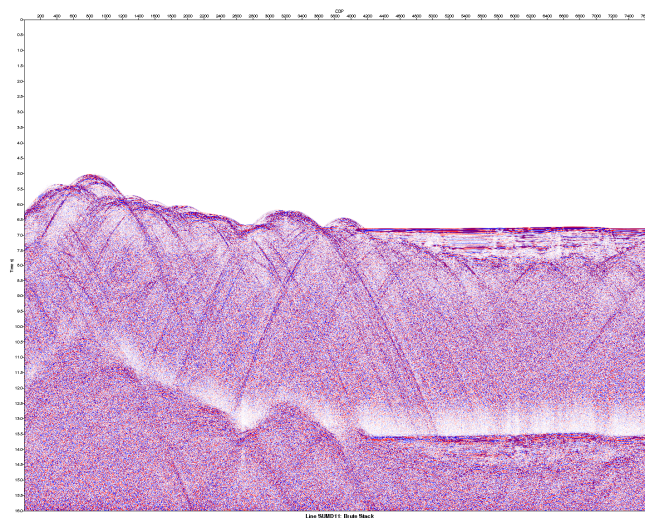

Figure 66: Stacked multichannel seismic section for profile SUMD11.

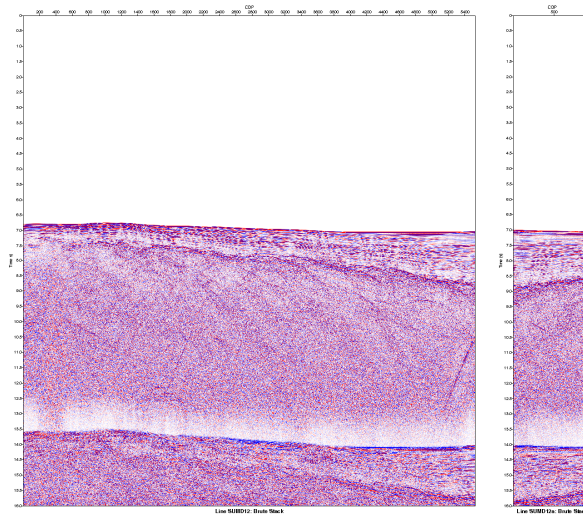

Figure 67: Stacked multichannel seismic sections for profile SUMD12 (left) and SUMD12a (right).

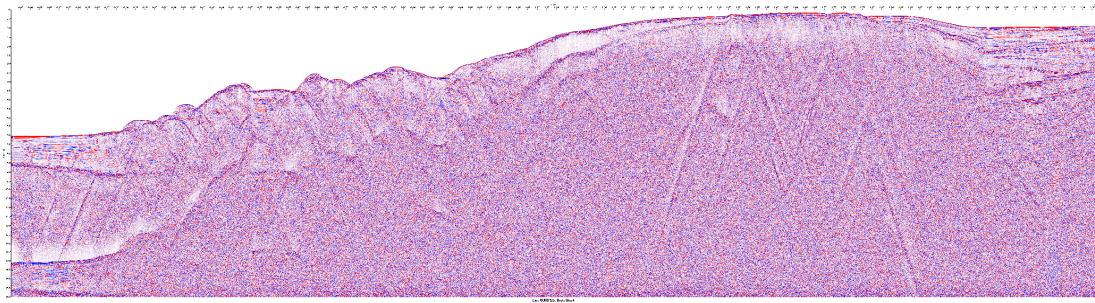

Figure 68: Stacked multichannel seismic section for profile SUMD12b.

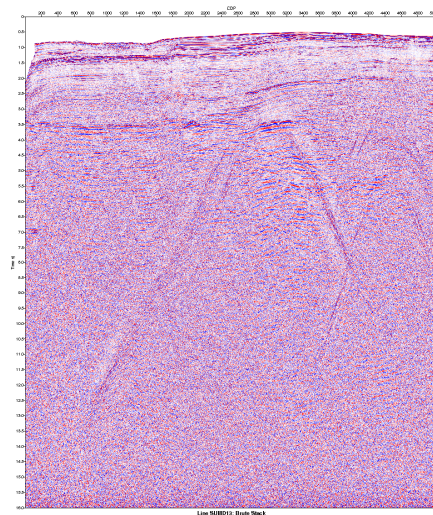

Figure 69: Stacked multichannel seismic section for profile SUMD13.

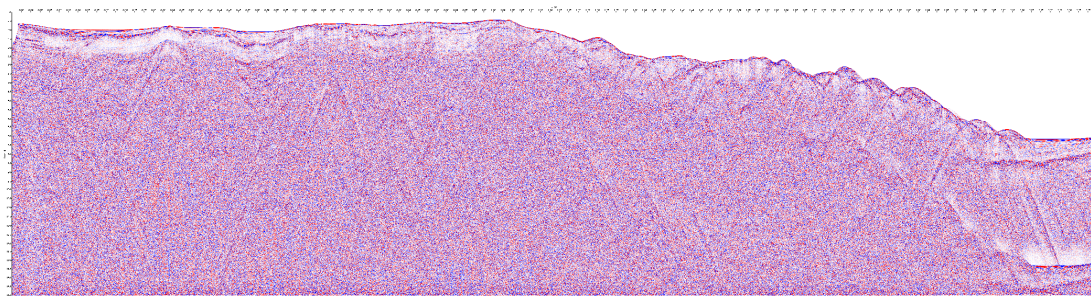

Figure 70: Stacked multichannel seismic section for profile SUMD14.

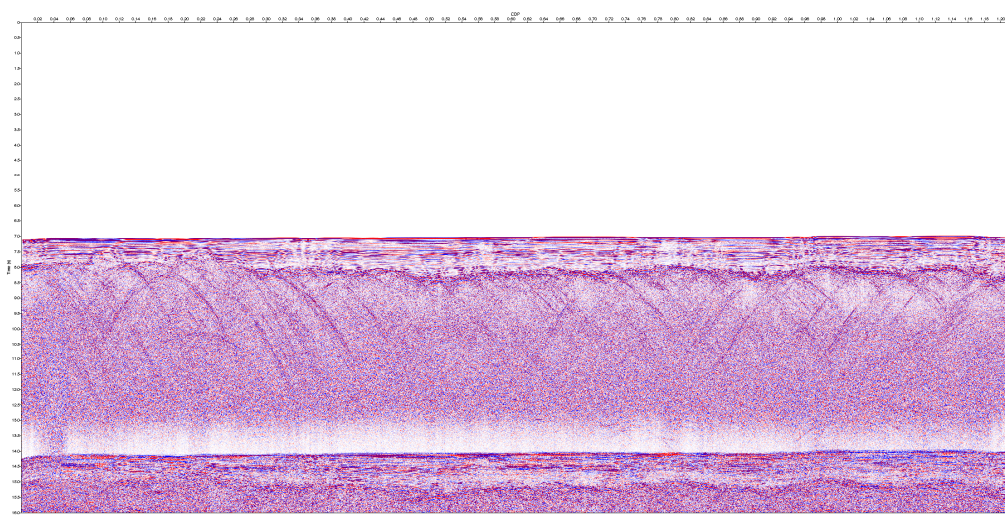

Figure 71: Stacked multichannel seismic section for profile SUMD15.

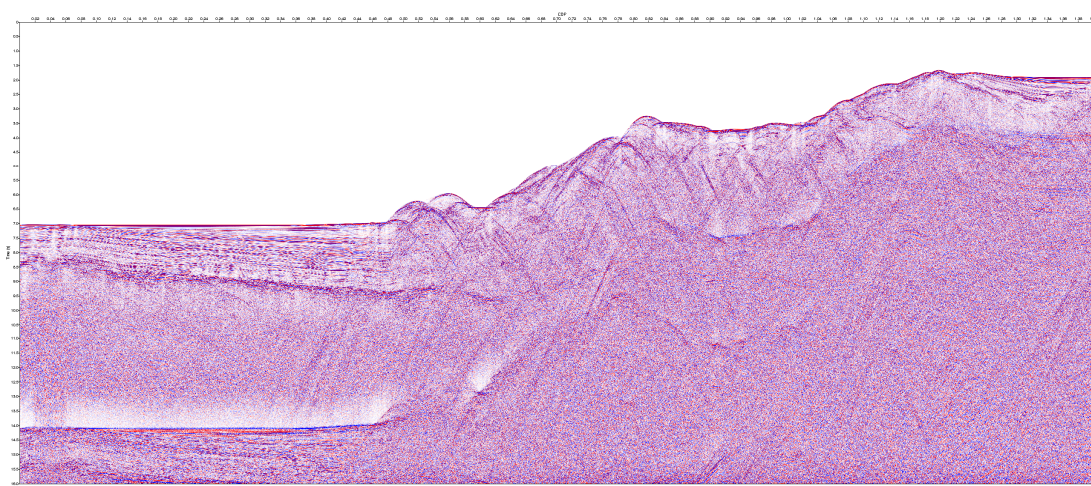

Figure 72: Stacked multichannel seismic section for profile SUMD16.

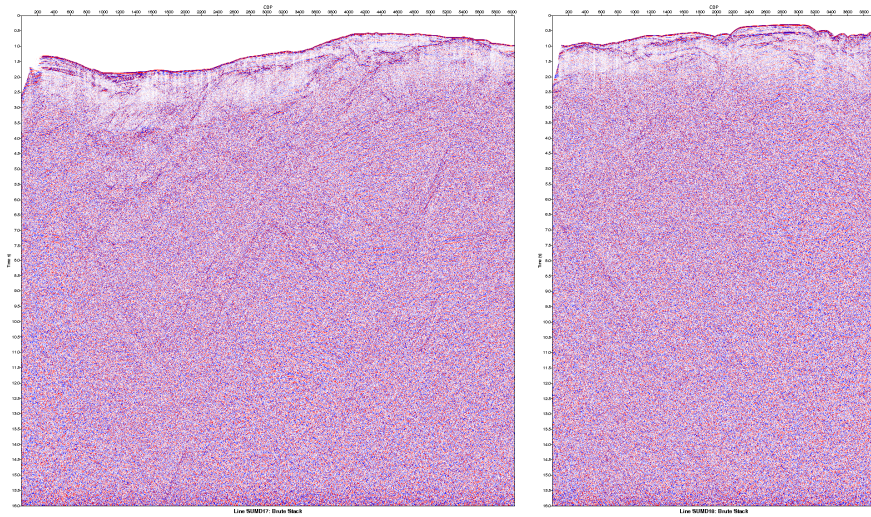

Figure 73: Stacked multichannel seismic sections for profile SUND17 (left) and SUND18 (right).

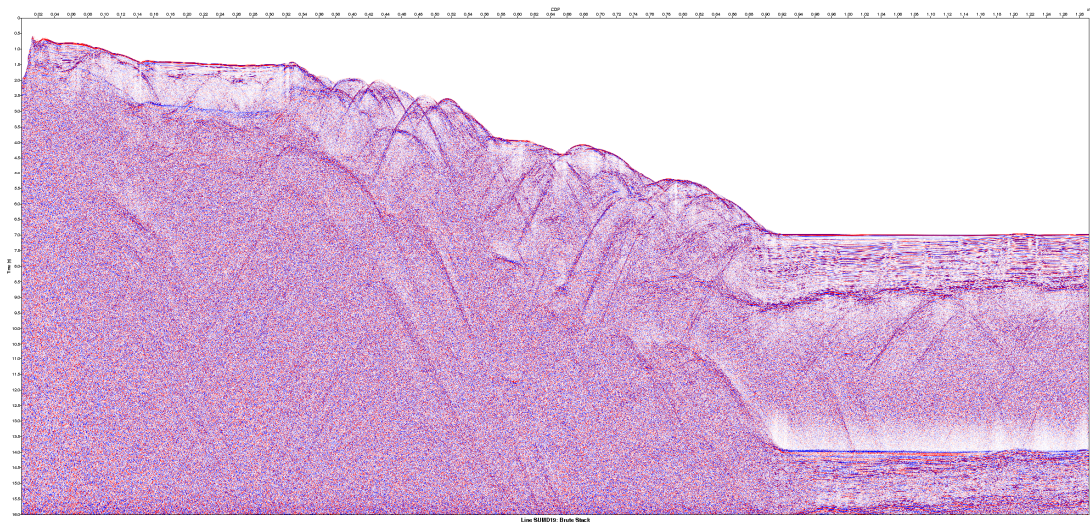

Figure 74: Stacked multichannel seismic section for profile SUND19.

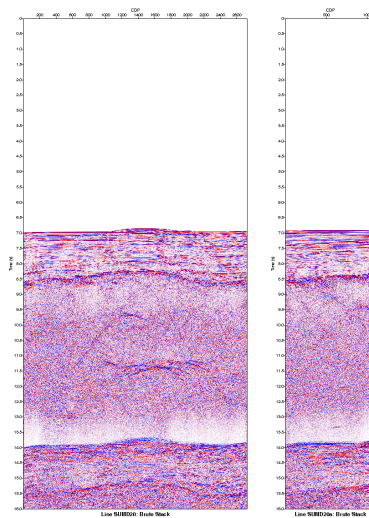

Figure 75: Stacked multichannel seismic sections for profile SUND20 (left) and SUND20a (right).

Expendable bathythermograph data

A total of 2 XBT probes were deployed during the period of MCS operations in Survey Box 2 (Table 17 and Figure 76). XBTs were only launched when the airguns were onboard the ship to avoid tangling the data-return wire, i.e., at the very start of the MCS survey. The XBT results (Figure 77) are very similar to those obtained by XBT, sound-velocity probe (SVP) and current-temperature-density probe (CTD) during SO198-1 (in Survey Box 2), and during the prologue to SO198-2 (Figure 44).

Sequence (deployment) number	Probe type	Latitude	Longitude	Approximate water depth (m)
109	T5	-2.48417	100.147	597
110		Not deployed		
111	T5	-0.523178	99.3022	895

Table 17: Launch details for XBTs deployed prior to MCS operations in Survey Box 2.

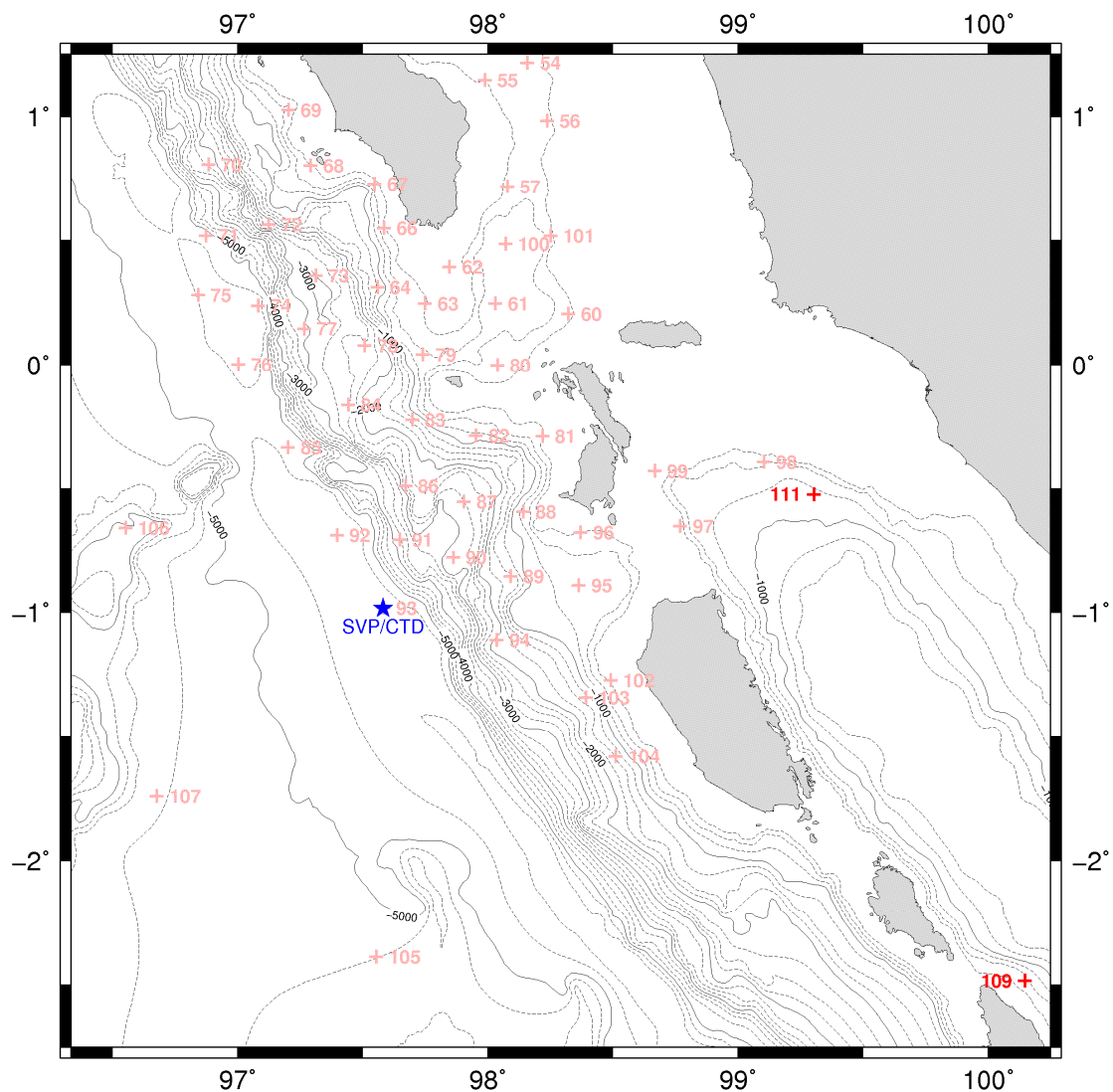

Figure 76: Location of the XBTs deployed prior to MCS operations in Survey Box 2 (red crosses) and their Sequence number; faint red crosses identify XBTs deployed during

SO198-1 and the prologue to SO198-2. The blue star shows the location of the nearest SVP/CTD deployment acquired during SO198-1.

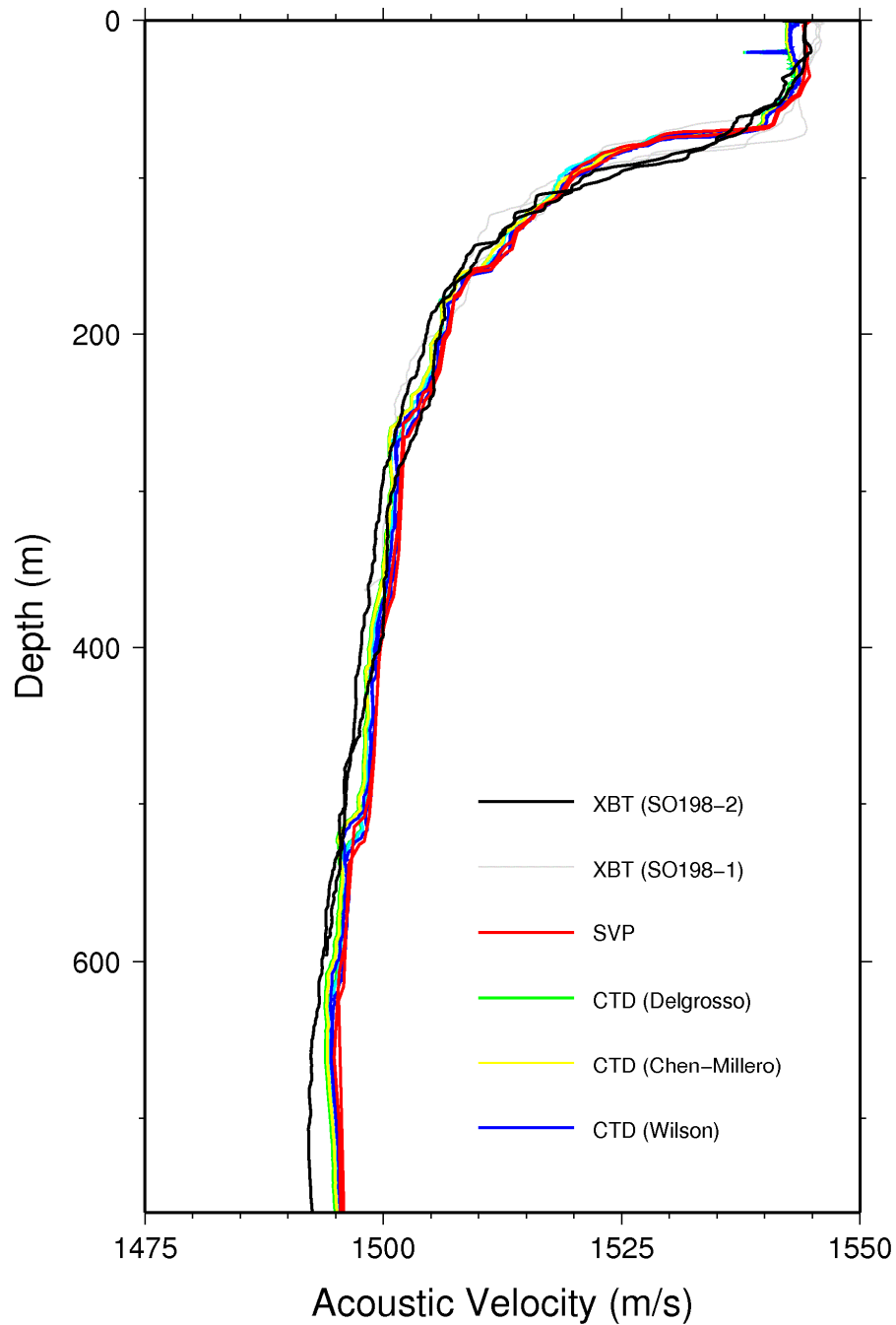

Figure 77: Acoustic velocity versus depth profiles obtained from the XBT probes launched prior to MCS operations in Survey Box 2 (black lines). Also shown are the velocity values obtained during SO198-1 by XBT Sequence numbers 97, 98 and 99, located in the basin west of Siberut (grey), SVP (red) and CTD (green, yellow and blue).

Swath bathymetry

Swath bathymetric data were acquired continually within the designated survey area (Figure 78).

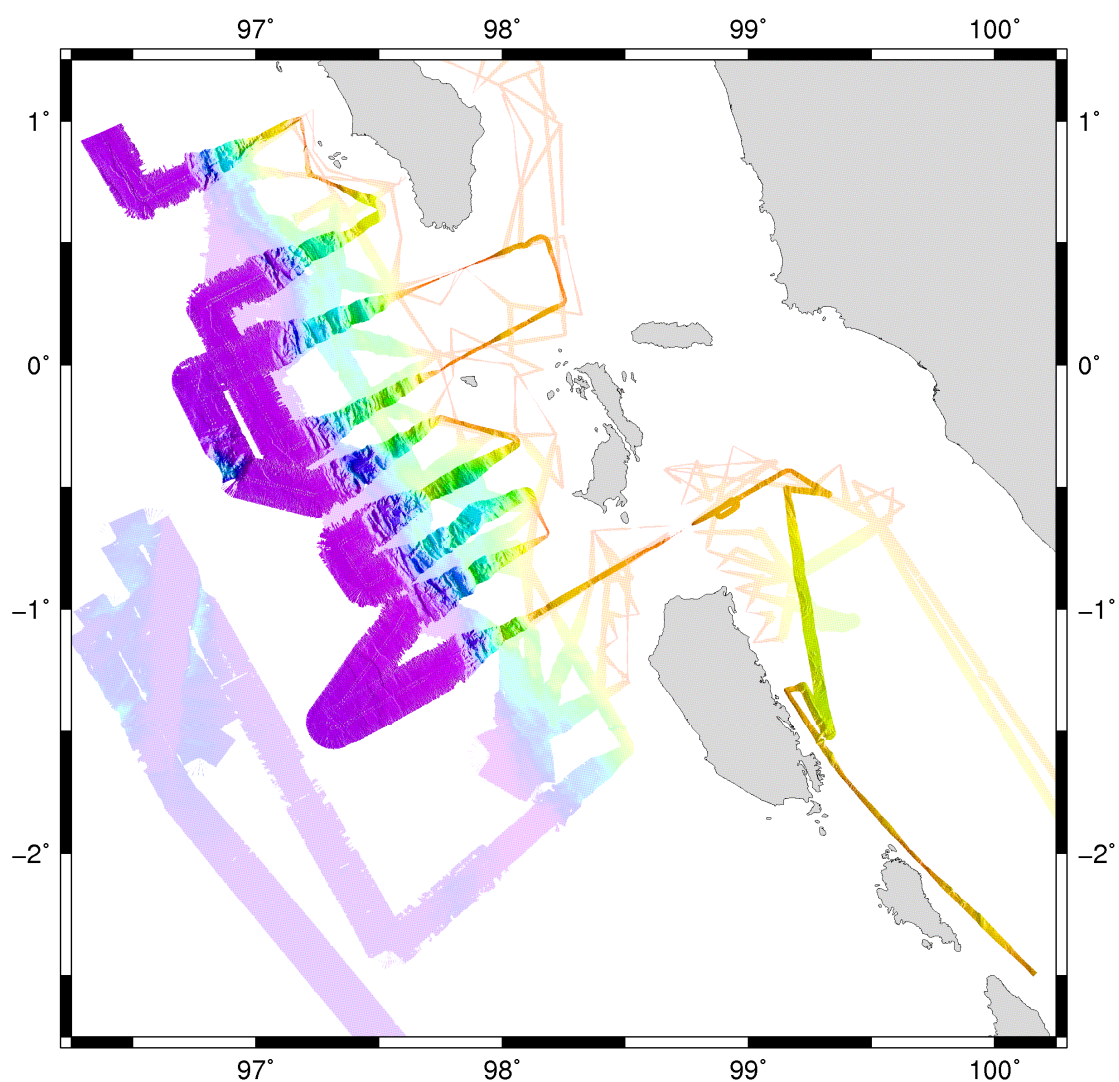

Figure 78: Raw swath bathymetric data acquired during MCS data acquisition in Survey Box 2. The data were gridded using Caris software. Illumination is from the south-west. Data from SO198-1 and the prologue to SO198-2 are shown in the background.

Parasound data

Parasound data were acquired continually within Survey Box 2, once inside the designated survey area (Figure 79).

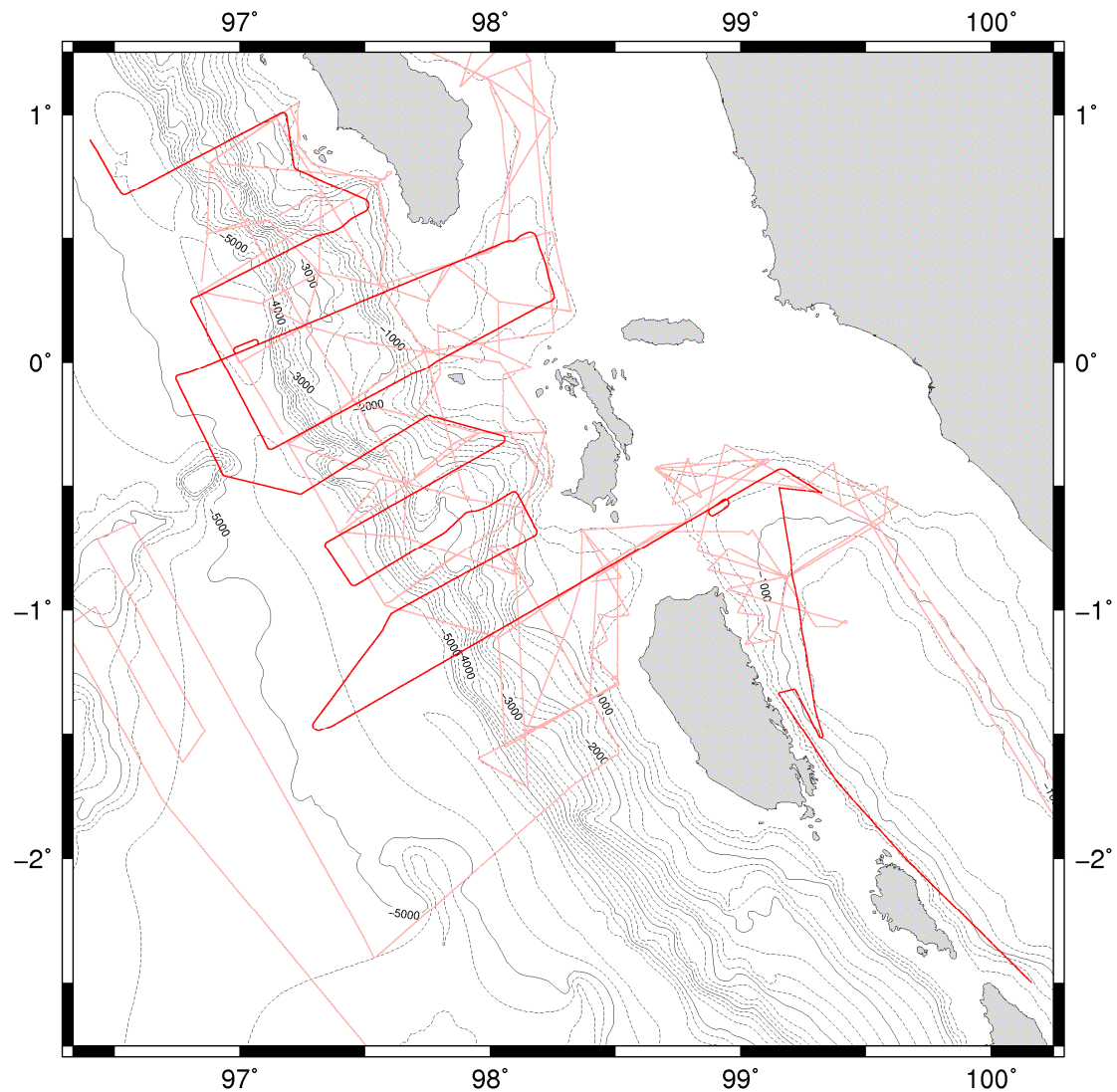

Figure 79: Location of the *Parasound* sub-bottom profiler data acquired in Survey Box 2 during MCS operations. Earlier profiles from SO198-1/2 are coloured faint red.

Gravity data

Data from the gravity data, logged at 1-minute intervals on the laptop in the gravity meter room, were corrected for the drift of the meter's clock and reduced to give the gravity anomaly (see Explanatory Notes). The results from Survey Box 2 are shown in Figure 80.

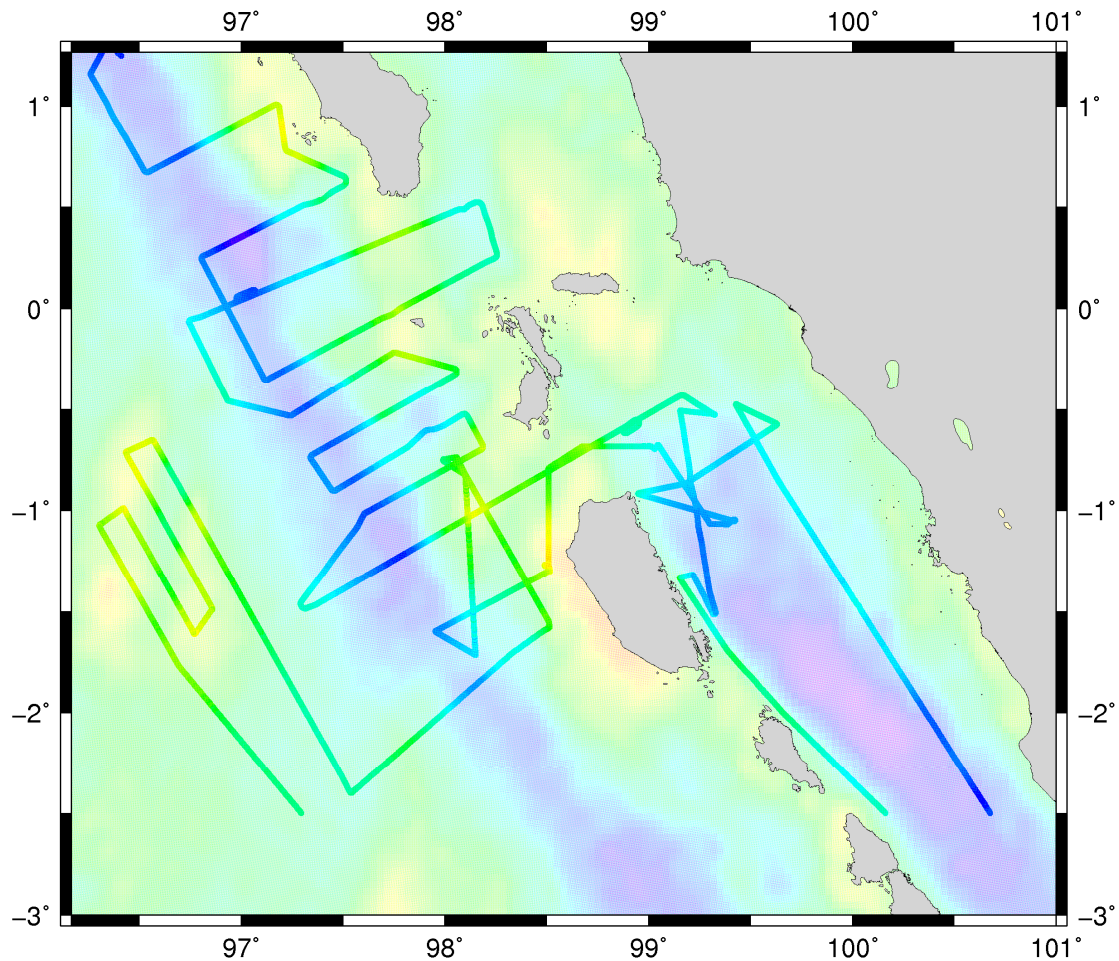

Figure 80: Gravity anomaly calculated from the 1-minute data for Survey Box 2 and the transit to and from Merak during the SO198-2 prologue. The background grid is from Sandwell and Smith (1997).

Magnetic data

Magnetic data were acquired during airgun shooting and inside the designated survey area during the transit from Merak. No data were collected during the section of SUMD01 from the basin area east of Siberut Island to the trench because of the shallow (<50 m) water depths charted north of Siberut Island. The magnetometer was turned off and brought close to the ship when the streamer was partially recovered on Julian Day 187 to add weight. The data acquisition software was restarted on Julian Day 190 in an attempt to synchronise with the GPS NMEA input. Data acquired are summarised in Table 18 and plotted in Figure 81.

File (.mag & .XYZ)	Start				End			
	Julian Day	UTC Time	Lat.	Long.	Julian Day	UTC Time	Lat.	Long.
sl_data_so198_2_005	185	08:50:52	-2.457	100.120	185	22:24:01	-0.523	99.157
sl_data_so198_2_006	187	02:38:41	-1.281	97.686	187	06:52:00	-1.466	97.368
sl_data_so198_2_007	187	08:50:30	-1.430	97.311	187	13:40:39	-1.109	97.550
sl_data_so198_2_008	187	16:03:30	-0.999	97.633	190	08:22:49	0.272	97.550
sl_data_so198_2_009	190	08:33:50	0.278	97.564	190	08:39:15	0.281	97.571
sl_data_so198_2_010	190	08:39:24	0.281	97.571	192	22:44:59	0.827	96.443

Table 18: Details of the files of magnetics data acquired during the MCS survey in Survey Box 2. Locations are for the ship.

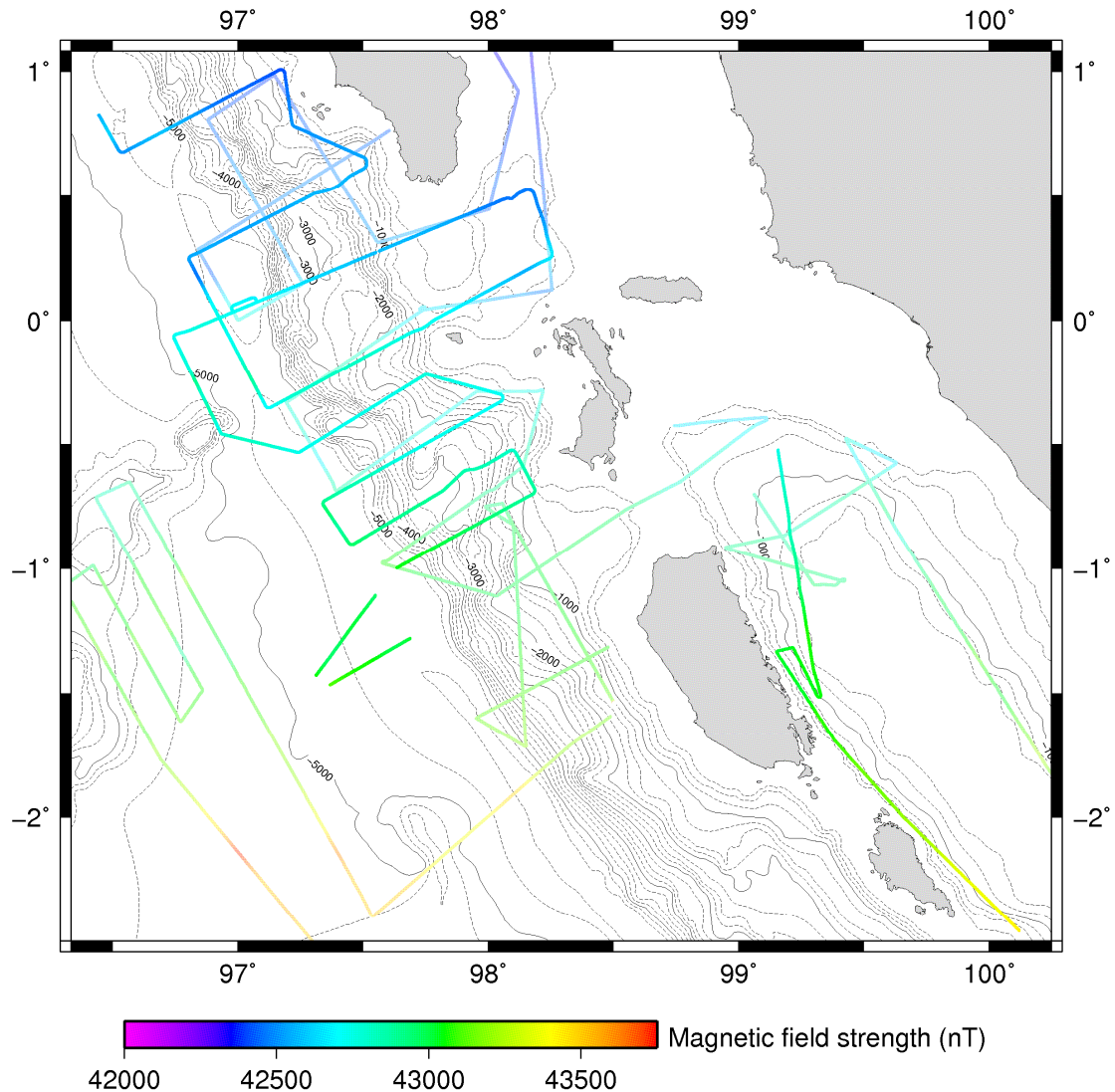

Figure 81: Magnetic field strength in nT measured during the MCS survey in Survey Box 2. Gaps in the data occur during transit north of Siberut Island, twice when the streamer was partially recovered on Julian Day 187, to add weight, and briefly on Julian Day 190 when the logging software was restarted. Earlier profiles from SO198-1/2 are coloured faintly. GEBCO 1-minute bathymetry is contoured every 250 m.

Results: Survey Box 1 (11th – 17th July)

As for Survey Box 2, the basic objective was to shoot a series of multichannel seismic (MCS) profiles. The swath bathymetry, sub-bottom profiler and gravity meter were operated continuously and, when possible, the magnetometer. XBT probes were deployed when the airguns were not being towed.

Survey narrative

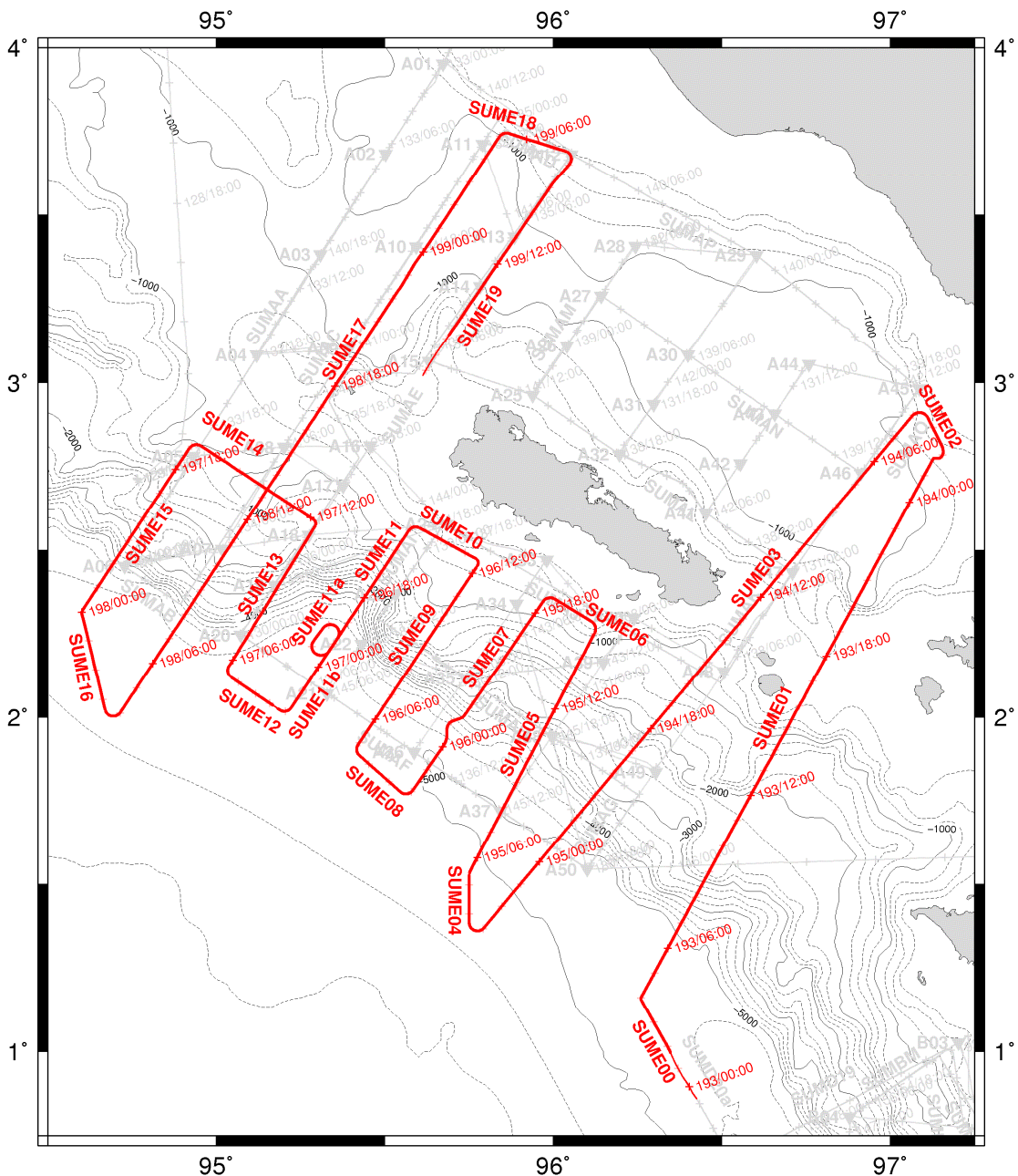

Figure 82: Map of survey tracks in Survey Box 1. Crosses indicate the position each hour and every 6 hours is labelled with Julian Day and UTC time. Swath and *Parasound* data were acquired continuously; bold lines identify multichannel seismic (MCS) profiles SUME00-SUME19. GEBCO 1-minute bathymetry is contoured every 250 m.

Julian Day 193, Thursday 11th July

After redeploying the streamer, with additional weight and the length of tow cable increased to 110 m, the survey continues with line SUME00 until the turn onto SUME01 at 10:56. The remainder of the day is calm, clear and sunny, although the southern swell continues. Some cloud cover appears on the horizon at sunset, followed by thunderstorms to the north. During the evening a 1 kt head current brings the front of the streamer to 4 m depth if we maintain 5 kt over the ground, and the speed is reduced until the depth is more controlled.

Julian Day 194, Thursday 12th July

Continuation of the seismic reflection survey in Survey Box 1. Overnight the head current stops, and the speed is increased slightly to prevent the streamer running too deep. The morning is clear and mostly calm. Some small fishing boats are passed without incident but at approximately 08:20 a local cargo boat is plotted on the radar as being likely to cross just ahead of us. Despite several minutes of trying to raise them on the VHF radio they maintain course, also apparently ignoring several minutes of sounding the ship's horn. An emergency turn to starboard is carried out at 08:40, together with diving the streamer, and the boat eventually passes approximately 150 m to the stern. Line SUME01 ends at 08:47, and SUME02 at 10:20. At 10:45, anomalously high-frequency signals are seen on the magnetometer trace, and the magnetometer is brought on board for a check; one of the 'O'-rings in the main tow connector has failed, and is replaced before the magnetometer is returned to the water. The weather remains fine throughout the day and the sun sets over the edge of Simeulue as we continue to shoot SUME03. Brute stacks are now being routinely produced the next day as soon as the Julian day navigation download is available.

Julian Day 195, Thursday 13th July

Continuation of the seismic reflection survey in Survey Box 1. The weather overnight is cloudy with heavy rain. Some temporary problems are experienced with air conditioning in the Geology laboratory and parts of deck 2; the fans on 'crush' run at maximum speed until temperatures reduce after breakfast. Gun 7, which has not had a working timebreak during the deployment, fails at 08:40 and is disabled. Line SUME03 is completed at 09:59. After the turn to northward on SUME04 we have again a following swell, and the data become noisier. Line SUME04 is completed at 12:20. The nominal streamer depth is increased to 12 m at 13:50, which reduces the noise to acceptable levels. For the shallower water from 18:20:30 the shot interval is decreased to 19 s and then to 18 s at 18:29:30 when testing shows that a gun pressure of 135-137 bar can be maintained with the reduced array capacity (gun 7 is off). Line SUME05 is completed at 22:05.

Julian Day 196, Thursday 14th July

Continuation of the seismic reflection survey in Survey Box 1. Line SUME06 is completed at 00:03. Good conditions for data acquisition overnight mean that streamer is returned to 10 m depth at 01:20. The shot interval is increased back to 20 s at 07:56:30 to reduce interference from the multiple. Line

SUME07 is completed at 08:57 and SUME08 at 11:30. The day is mostly fine but cloudy, with thunderstorms around us at sunset. The shot interval is reduced to 18 s at 14:48:30. Line SUME09 is completed at 19:19 and SUME10 at 21:40. From a suggestion at teatime, Matthias generates a program to log the serial port output of the gravimeter against a GPS NMEA string by early evening.

Julian Day 197, Thursday 15th July

Continuation of the seismic reflection survey in Survey Box 1. The shot interval is increased to 20 s at 02:57:54 as we descend the steep slopes of the subduction front, but causes shot triggers to stop. Triggers are restored at 03:03:30 but almost 1 km of the line has been lost at a critical location and a circle is called, taking approximately three hours. Line SUME11 therefore ends at 03:03:30, SUME11a, on the circle, ends at 04:54, and SUME11b (to the original end of line) at 08:44. Line SUME12 is on the incoming plate and has a favourable orientation for handling the gear being towed; the ship is slowed, the magnetometer brought alongside, and the starboard side guns (7-12) are brought on board for servicing. The umbilical is found to be tightly wrapped in blue fishing net, and the high-pressure hose for gun 7 is shredded, showing why the gun had failed. All the high-pressure hoses are replaced quickly and efficiently, and the guns are back in the water at 11:29, and the nominal 5 kt acquisition speed is regained. The starboard gun array includes the 250 cu.in. guns, and the bubble pulse is more noticeable with just the port guns 1-6 in the water, as expected from the source predictions. Line SUME12 is completed at 12:17. During the afternoon to early evening there are frequent heavy showers together with two apparently perpendicular sets of swell. The rain stops just before a dramatic sunset. Line SUME13 is completed at 18:36, and SUME14 at 23:40.

Julian Day 198, Thursday 16th July

Continuation of the seismic reflection survey in Survey Box 1. Line SUME15 is completed at 06:56, and we start the deep inside turn at the end of SUME16 at 10:26. The number of autofire warnings recorded on the *Longshot* for guns 5 and 8 increases during the morning, although the fire pulse waveforms are unchanged and there is no evidence of a problem in the seismic data. Gun 7 again starts losing air at 11:13, and is disabled. The shot interval is reduced to 18 s at 18:22:30. Into the evening the wind increases from the west, with a sustained speed up to 12 m/s. Acquisition conditions are noisy, and despite numerous attempts to deepen it, the front of the streamer runs at 5-6 m for several hours.

Julian Day 199, Thursday 17th July

Continuation of the seismic reflection survey in Survey Box 1. Strong winds continue overnight, with the ship's speed over the ground having to be reduced at times to 4 kt in order to maintain the streamer depth and reduce noise. Once east of the forearc high there is some degree of shelter from the sea and conditions improve, although some degree of wind and short wavelength swell is present throughout the day. Line SUME17 is completed at 11:57, and SUME18 at 14:26. The line of SUME19 is surveyed until 21:55; the

magnetometer is brought on board at 21:45, then the guns were disabled and retrieved followed by the streamer.

Julian Day 200, Thursday 18th July

Continuation of the retrieval of the streamer. The tail buoy is brought on board at 00:20 just as the swell starts to pick up and boat's rolling increases. Transit overnight to the UTIG survey area.

Seismic source

Start			End			Shot Int. (s)	Line/comment
Julian Day	UTC Time	Longshot No.	Julian Day	UTC Time	Longshot No.		
193	01:45:50	28974	193	03:54:50	29361	20	SUME00
193	03:56:30	29366	194	01:47:10	33298	20	SUME01
193	16:24:10	31609				20	Pressure loss, compressors adjusted
194	01:48:30	33302	194	03:22:50	33585	20	SUME02
194	03:24:50	33591	195	02:59:30	37835	20	SUME03
195	01:39:50	37595				20	Gun 7 disabled
195	03:01:50	37841	195	05:20:30	38257	20	SUME04
195	05:24:30	38269	195	15:01:00	40069	20	SUME05
195	11:20:30	39336				19	
195	11:29:30	39364				18	
195	15:04:54	40082	195	17:01:18	40470	18	SUME06
195	17:03:24	40477	196	01:55:50	42232	18	SUME07
195	22:36:06	41586				18	Turn to avoid fishing vessel
196	00:56:30	42054				20	
196	01:57:50	42238	196	04:28:30	42690	20	SUME08
196	04:30:50	42697	196	12:15:48	44178	20	SUME09
196	07:48:30	43287				18	
196	12:19:42	44191	196	14:40:06	44659	18	SUME10
196	14:43:24	44670	196	20:11:50	45740	18	SUME11
196	19:56:36	45714				18	Break in shooting
196	20:03:30	45715				20	Restart shooting
196	20:14:10	45747	196	21:53:30	46045	20	SUME11a, turning to fill gap in line
196	21:55:10	46050	197	01:44:10	46736	20	SUME11b
197	01:46:10	46742	197	05:17:50	47311	20	SUME12
197	02:22:30	46851					Airguns off, fixing Gun 7
197	02:44:50	46852				20	Guns 1-6 on
197	04:32:30	47175				20	Guns 1-12 on
197	05:23:30	47328	197	11:36:10	48446	20	SUME13
197	11:39:50	48457	197	16:40:10	49358	20	SUME14
197	16:43:30	49368	197	23:56:30	50667	20	SUME15
197	23:58:50	50674	198	03:21:50	51283	20	SUME16
198	03:24:30	51291	199	04:57:18	56240	20	SUME17
198	11:00:10	52658				20	Pressure low: 113 bar
198	11:22:30	52724				18	
199	04:59:06	56246	199	07:26:06	56736	18	SUME18
199	07:29:06	56746	199	14:48:18	58210	18	SUME19
199	14:51:18	58220				18	Guns off

Table 19: Log of the airgun shooting interval and *LongShot* number versus the start and end times for each MCS line, as recorded by the watch keeper.

Multichannel seismic reflection data

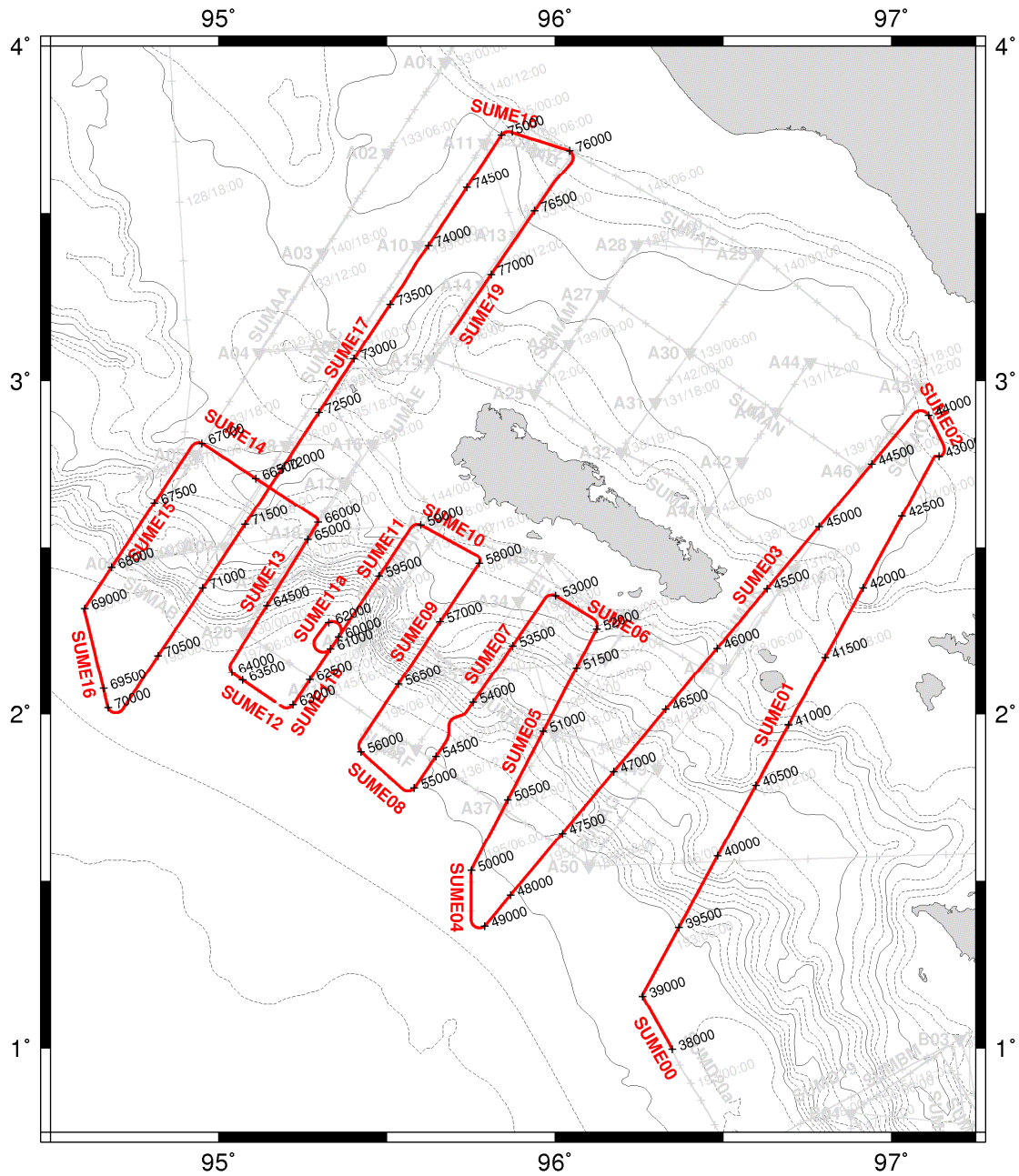

Figure 83: Shot point (FFID) map for multichannel seismic (MCS) profiles SUME00-SUME19 in Survey Box 1. Black crosses identify every 500 FFIDs. GEBCO 1-minute bathymetry is contoured every 250 m.

Line	Start					End				
	Julian Day	Sercel Time	FFID No.	Lat.	Long.	Julian Day	Sercel Time	FFID No.	Lat.	Long.
SUME00	193	01:45:28	38000	0.997	96.347	193	03:54:28	38387	1.154	96.261
SUME01	193	03:56:08	39000	1.156	96.260	194	01:46:48	42932	2.774	97.139
SUME02	194	01:48:08	43000	2.774	97.141	194	03:22:28	43283	2.894	97.111
SUME03	194	03:24:28	44000	2.897	97.110	195	02:59:07	48244	1.368	95.792
SUME04	195	03:01:27	49000	1.365	95.790	195	05:20:07	49416	1.526	95.750
SUME05	195	05:24:07	50000	1.532	95.751	195	15:00:37	51800	2.251	96.121

SUME06	195	15:04:31	52000	2.256	96.124	195	17:00:55	52388	2.354	96.004
SUME07	195	17:03:01	53000	2.356	96.002	196	01:55:27	54755	1.782	95.583
SUME08	196	01:57:27	55000	1.779	95.581	196	04:28:07	55452	1.885	95.425
SUME09	196	04:30:27	56000	1.887	95.423	196	12:15:25	57481	2.449	95.771
SUME10	196	12:19:19	58000	2.453	95.774	196	14:39:42	58468	2.565	95.604
SUME11	196	14:43:01	59000	2.567	95.600	196	20:11:26	60070	2.199	95.334
SUME11a	196	20:13:47	61000	2.196	95.332	196	21:53:06	61298	2.275	95.325
SUME11b	196	21:54:46	62000	2.276	95.327	197	01:43:46	62687	2.029	95.222
SUME12	197	01:45:47	63000	2.027	95.221	197	05:17:26	63569	2.120	95.045
SUME13	197	05:23:06	64000	2.125	95.039	197	11:35:46	65118	2.571	95.293
SUME14	197	11:39:26	66000	2.576	95.295	197	16:39:46	66901	2.812	94.954
SUME15	197	16:43:06	67000	2.813	94.950	197	23:56:06	68299	2.320	94.603
SUME16	197	23:58:26	69000	2.317	94.601	198	03:21:26	69609	2.023	94.670
SUME17	198	03:24:06	70000	2.019	94.671	199	04:56:53	74949	3.733	95.839
SUME18	199	04:58:41	50000	3.735	95.840	199	07:25:41	75490	3.690	96.038
SUME19	199	07:28:41	76000	3.688	96.042	199	14:47:53	77464	3.141	95.690

Table 20: Start and end times, FFID numbers and locations for multichannel seismic (MCS) lines SUME00-SUME19 in Survey Box 1. Times are extracted from the SEG-D headers and represent the system time on the Sercel, not UTC, although the clock was synchronised to UTC at the start of the experiment and is therefore correct to seconds.

Start		End		Depth	Comments
Julian Day	UTC Time	Julian Day	UTC Time		
193	01:45	193	21:00	10	Streamer recovered, extra weight added; Bird 1 consistently 6-8 m
193	21:00	194	21:40	10	
194	21:40	195	06:50	10	Bird 1 consistently 6-8 m; Gun 7 lost at 195/01:40
195	06:50	195	17:01	12	
195	17:01	195	18:20	12	Bird 1 consistently 7-8 m
195	18:20	196	01:56	10	Bird 1 5-7 m
196	01:56	196	09:40	10	
196	09:40	196	12:15	10	Bird 1 consistently 5.5-8 m
196	12:15	196	14:40	10	Bird 1 consistently 12-14 m
196	14:40	197	01:44	10	Trigger box error at 196/19:56
197	01:44	197	04:32	10	Starboard guns out of action for repairs, ship slowed, Bird 1 consistently around 20 m, Bird 2 occasionally as deep as 15 m
197	04:32	197	05:17	10	All guns back operational
197	05:17	197	14:40	10	
197	14:40	197	16:40	10	Bird 1 consistently 7-8 m
197	16:40	197	23:56	10	Bird 1 consistently 12-14 m
197	23:56	198	03:21	10	
198	03:21	199	04:57	10	Bird 1 consistently 6-8 m, occasionally as high as 4 m; gun 7 lost at 198/11:00
199	04:57	199	14:48	10	

Table 21: Log of the streamer depth, set by command to the depth control birds, during the acquisition of MCS (MCS) lines SUME00-SUME19 in Survey Box 1.

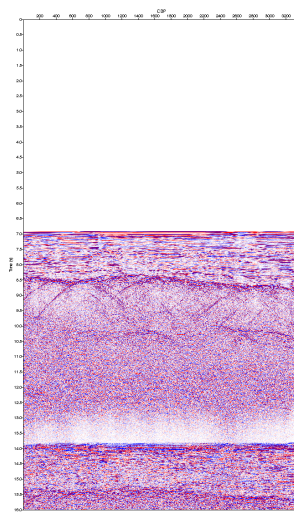

Figure 84: Stacked multichannel seismic section for profile SUME00.

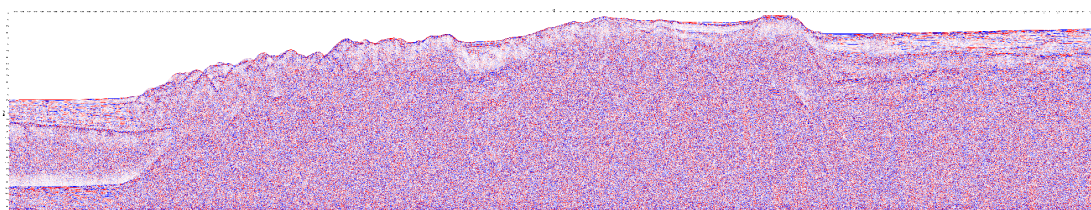

Figure 85: Stacked multichannel seismic section for profile SUME01.

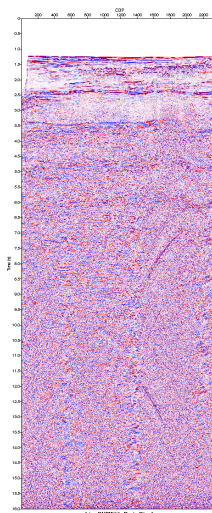

Figure 86: Stacked multichannel seismic section for profile SUME02.

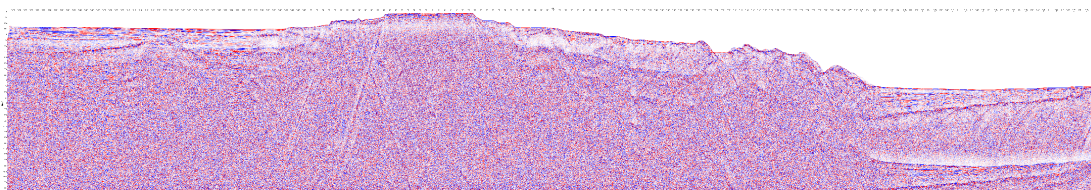

Figure 87: Stacked multichannel seismic section for profile SUME03.

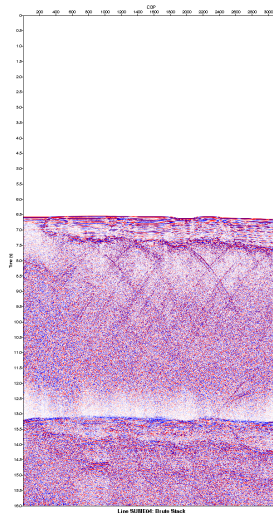

Figure 88: Stacked multichannel seismic section for profile SUME04.

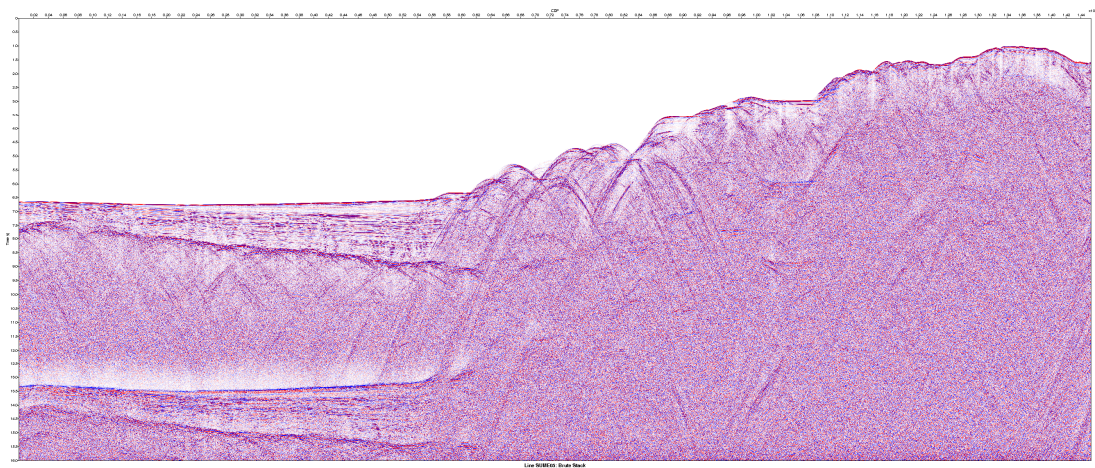

Figure 89: Stacked multichannel seismic section for profile SUME05.

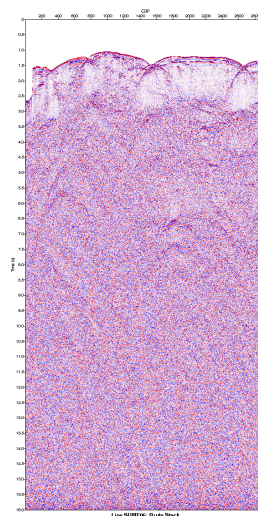

Figure 90: Stacked multichannel seismic section for profile SUME06.

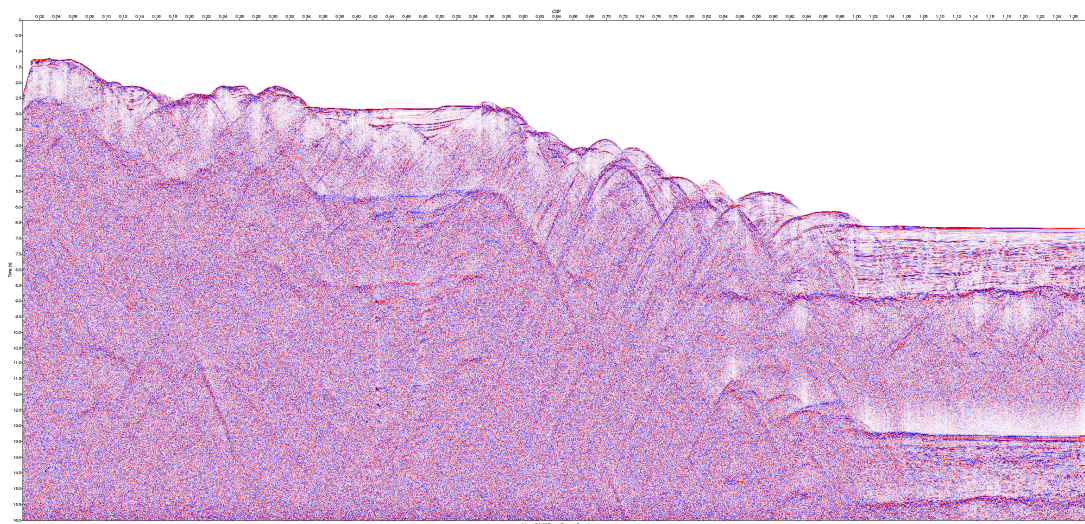

Figure 91: Stacked multichannel seismic section for profile SUME07.

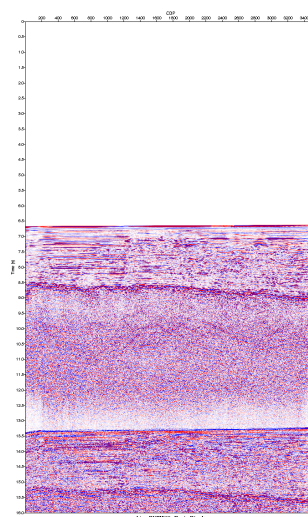

Figure 92: Stacked multichannel seismic section for profile SUME08.

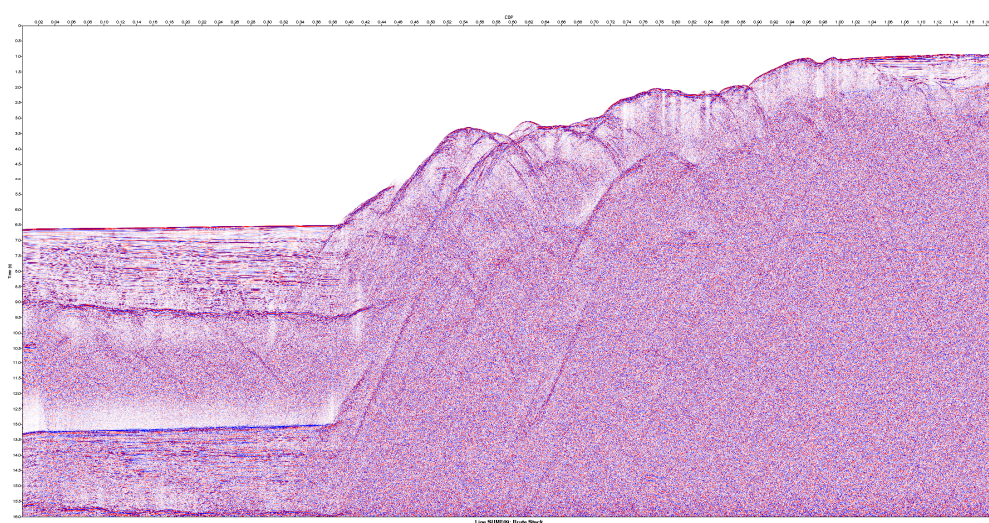

Figure 93: Stacked multichannel seismic section for profile SUME09.

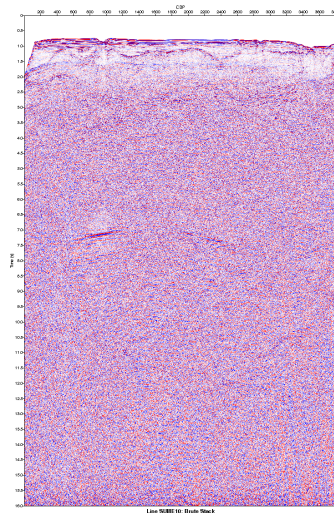

Figure 94: Stacked multichannel seismic section for profile SUME10.

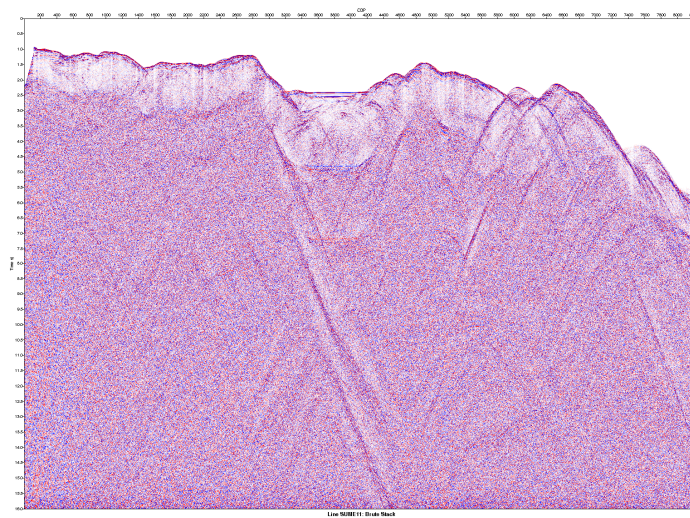

Figure 95: Stacked multichannel seismic section for profile SUME11.

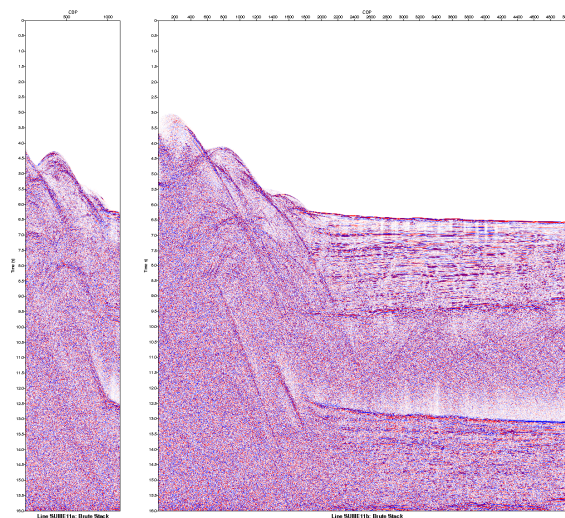

Figure 96: Stacked multichannel seismic sections for profile SUME11a and SUME11b.

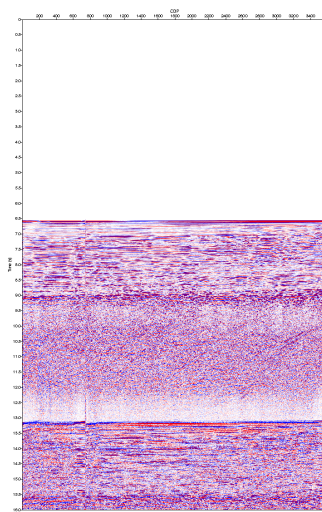

Figure 97: Stacked multichannel seismic section for profile SUME12.

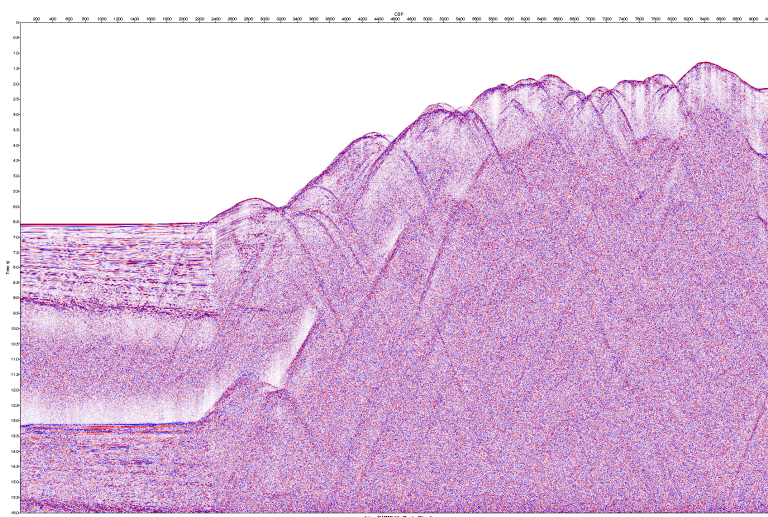

Figure 98: Stacked multichannel seismic section for profile SUME13.

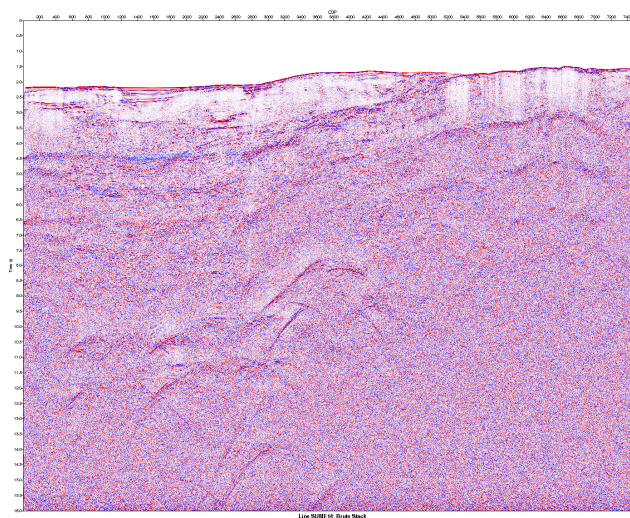

Figure 99: Stacked multichannel seismic section for profile SUME14.

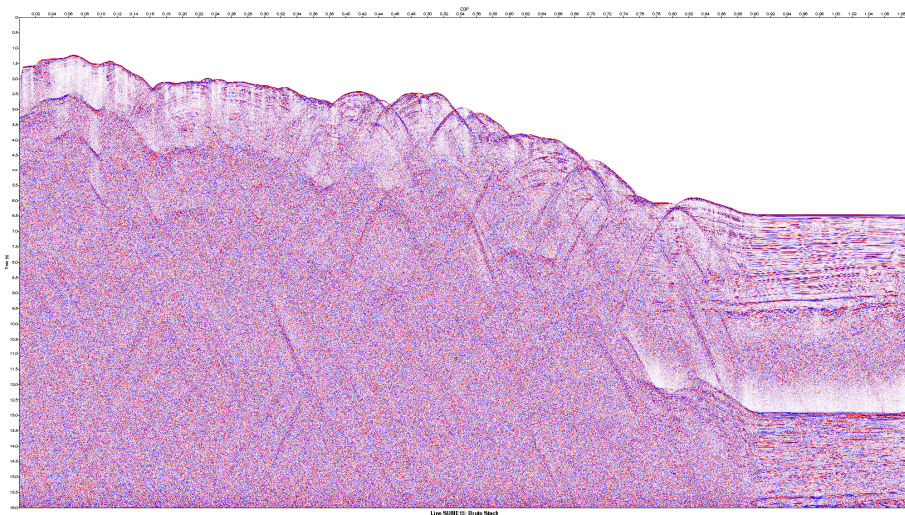

Figure 100: Stacked multichannel seismic section for profile SUME15.

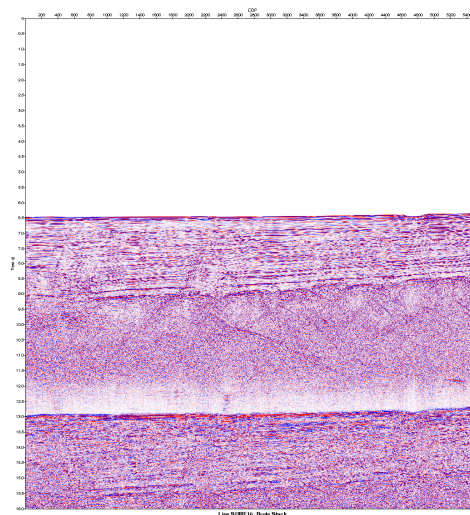

Figure 101: Stacked multichannel seismic section for profile SUME16.

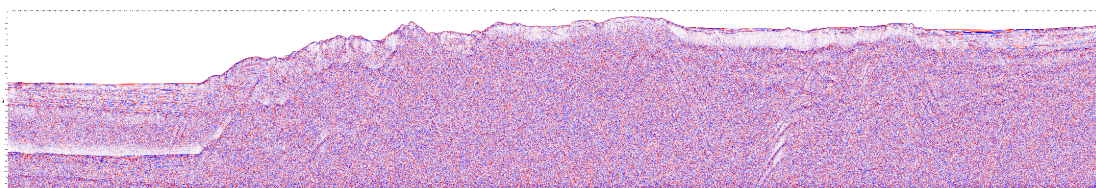

Figure 102: Stacked multichannel seismic section for profile SUME17.

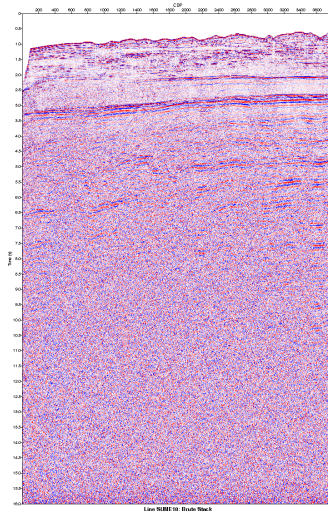

Figure 103: Stacked multichannel seismic section for profile SUME18.

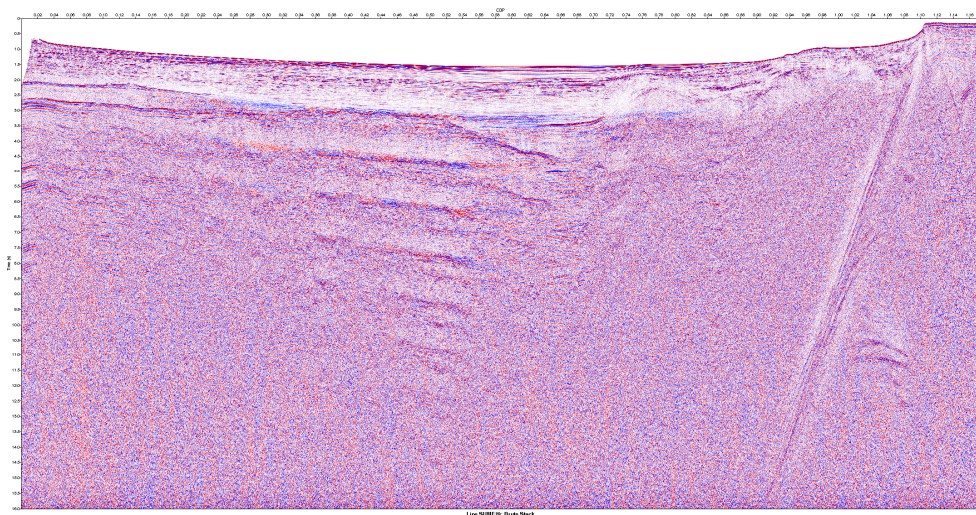

Figure 104: Stacked multichannel seismic section for profile SUME19.

Expendable bathythermograph data

A total of 4 XBT probes were deployed after the MCS operations in Survey Box 2 (Table 22 and Figure 105), when the airguns were onboard the ship. The XBT velocity results obtained now (Figure 106) are significantly lower at depths <250 m than those obtained by XBT, sound-velocity probe (SVP) and current-temperature-density probe (CTD) during SO198-1 (in Survey Box 1).

Sequence (deployment) number	Probe type	Latitude	Longitude	Approximate water depth (m)
112	T7	3.04175	95.6244	317
113	T7	3.0021	95.1001	600
114	T7	2.82256	94.568	2031
115	T7	2.63752	94.1743	4700

Table 22: Launch details for XBTs deployed after MCS operations in Survey Box 1.

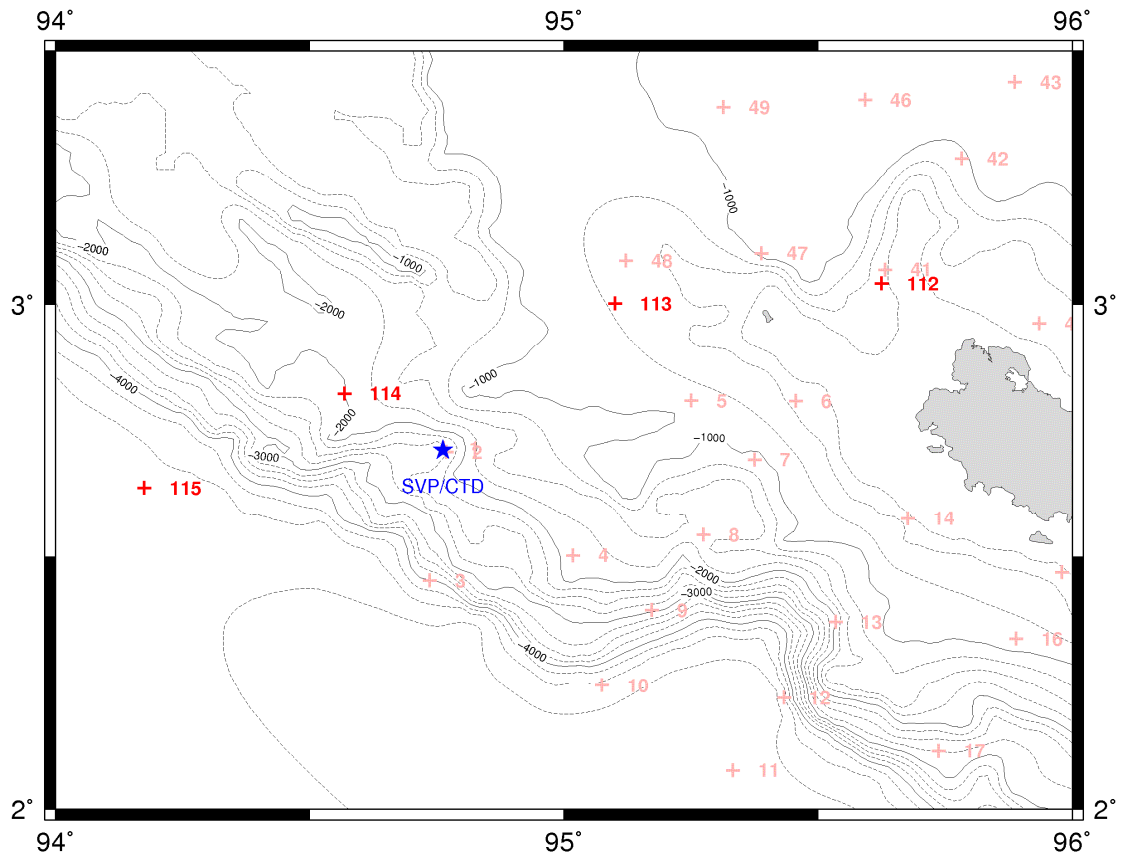

Figure 105: Location of the XBTs deployed after the MCS operations in Survey Box 1 (red crosses) and their Sequence number; faint red crosses identify XBTs deployed during SO198-1. The blue star shows the location of the nearest SVP/CTD deployment acquired during SO198-1.

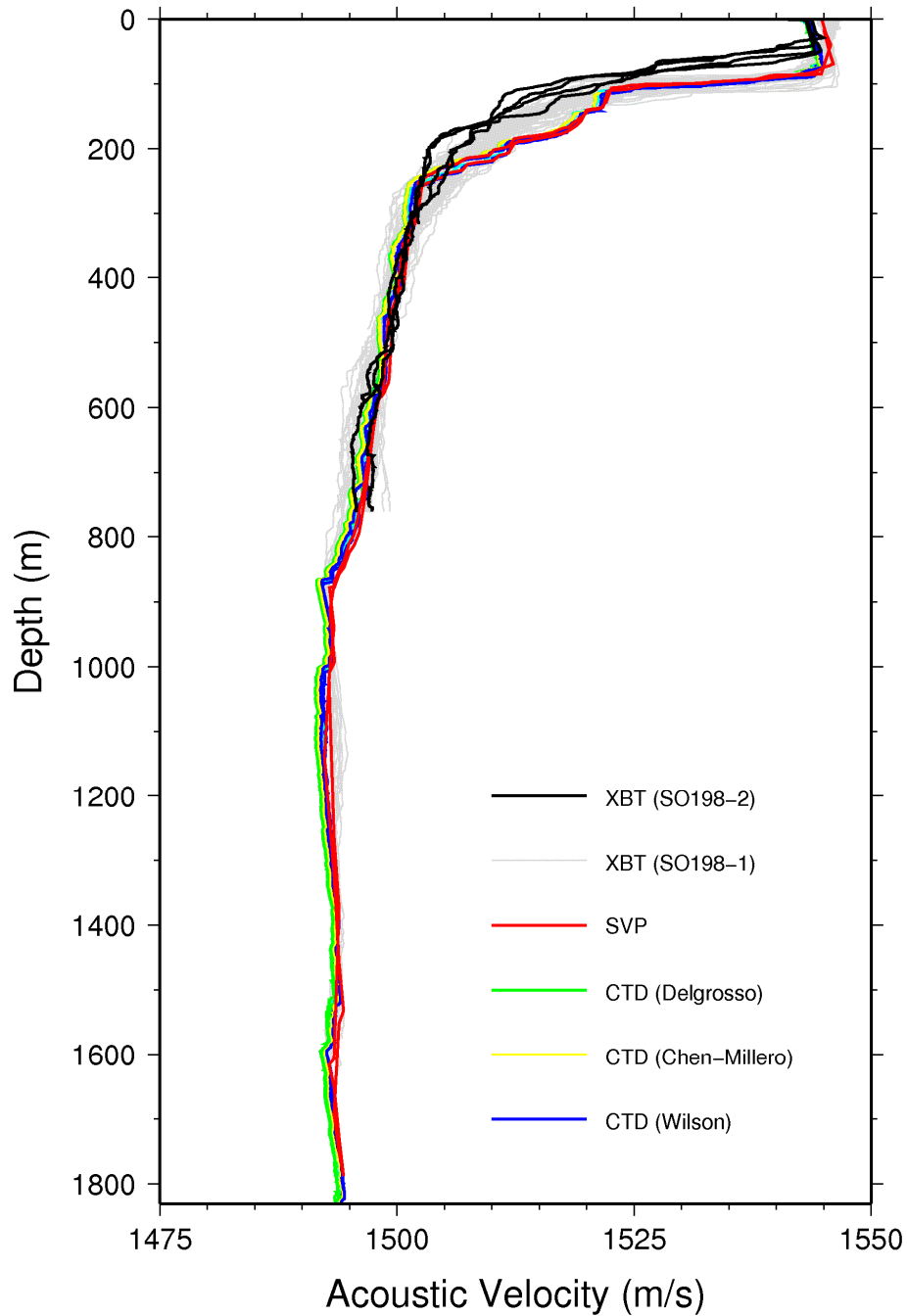

Figure 106: Acoustic velocity versus depth profiles obtained from the XBT probes launched after MCS operations in Survey Box 1 (black lines). Also shown are the velocity values obtained during SO198-1 by XBT (grey), SVP (red) and CTD (green, yellow and blue).

Swath bathymetry

Swath bathymetric data were acquired continually within the designated survey area (Figure 107).

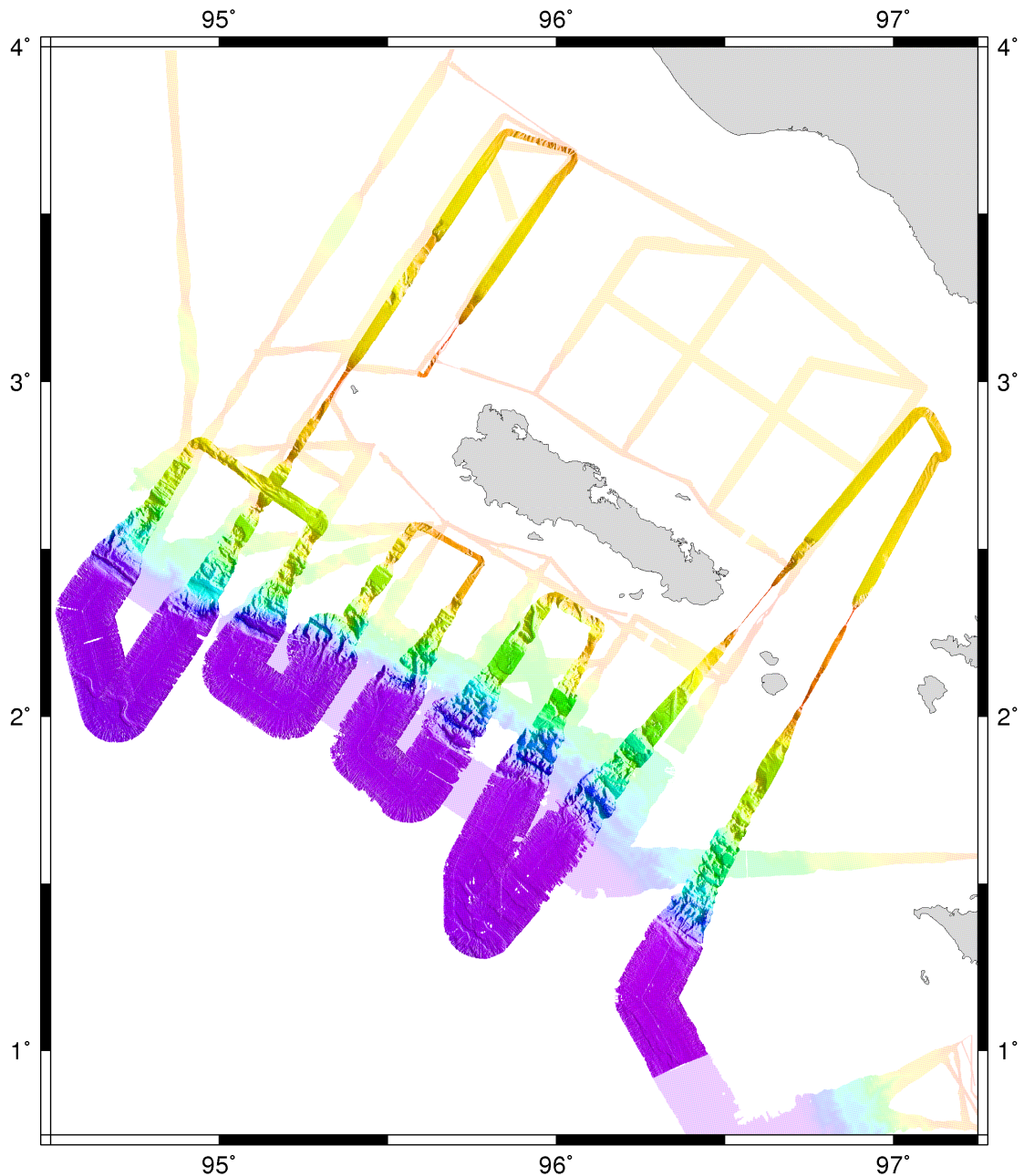

Figure 107: Raw swath bathymetric data acquired during MCS data acquisition in Survey Box 1. The data were gridded using Caris software. Illumination is from the south-west. Data from SO198-1 are shown in the background.

Parasound data

Parasound data were acquired continually within Survey Box 1 (Figure 108).

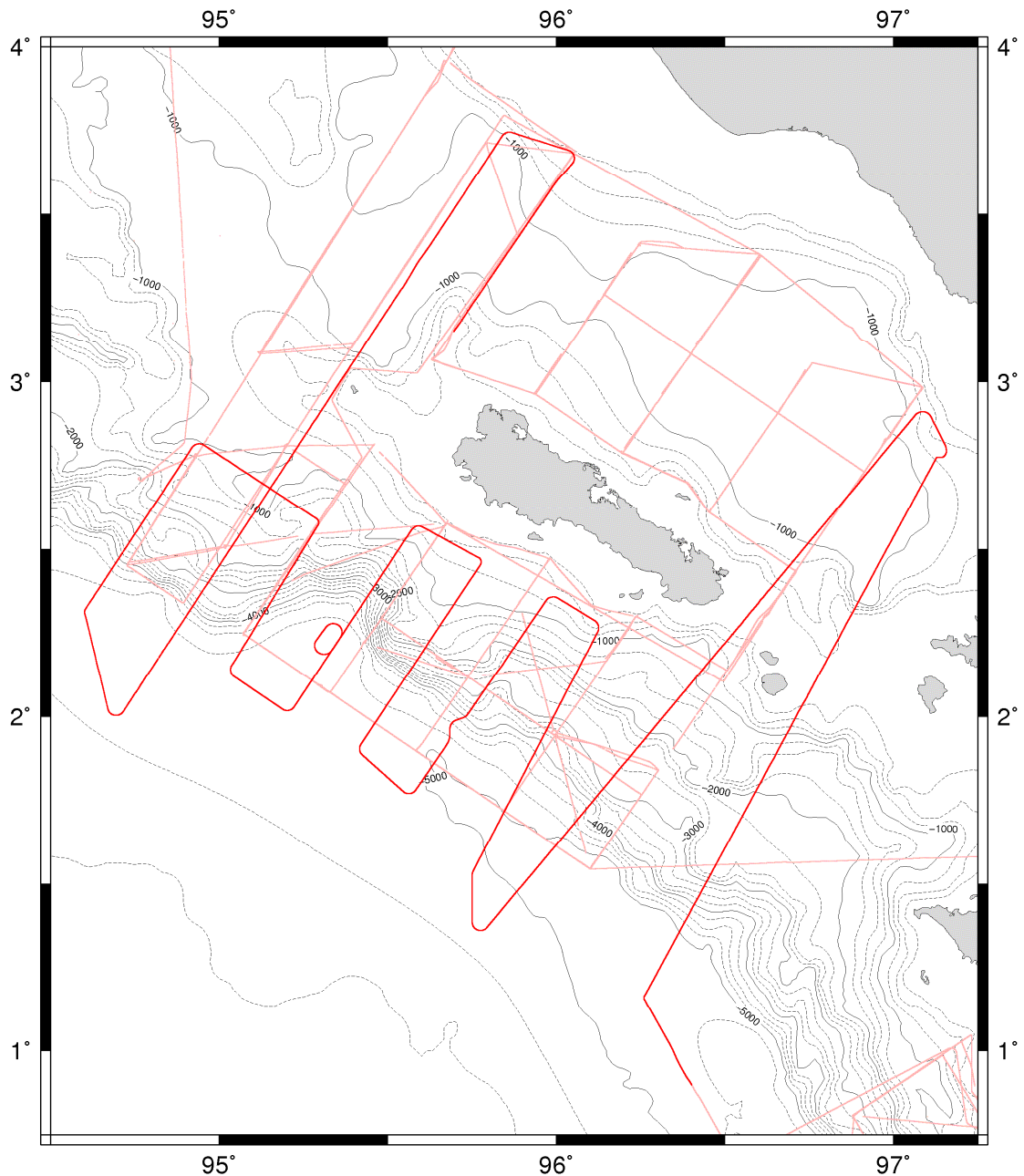

Figure 108: Location of the *Parasound* sub-bottom profiler data acquired in Survey Box 1. Earlier profiles from SO198-1/2 are coloured faint red.

Gravity data

Data from the gravity data, logged at 1-minute intervals on the laptop in the gravity meter room, were corrected for the drift of the meter's clock and reduced to give the gravity anomaly (see Explanatory Notes). The results from Survey Box 1 are shown in Figure 109.

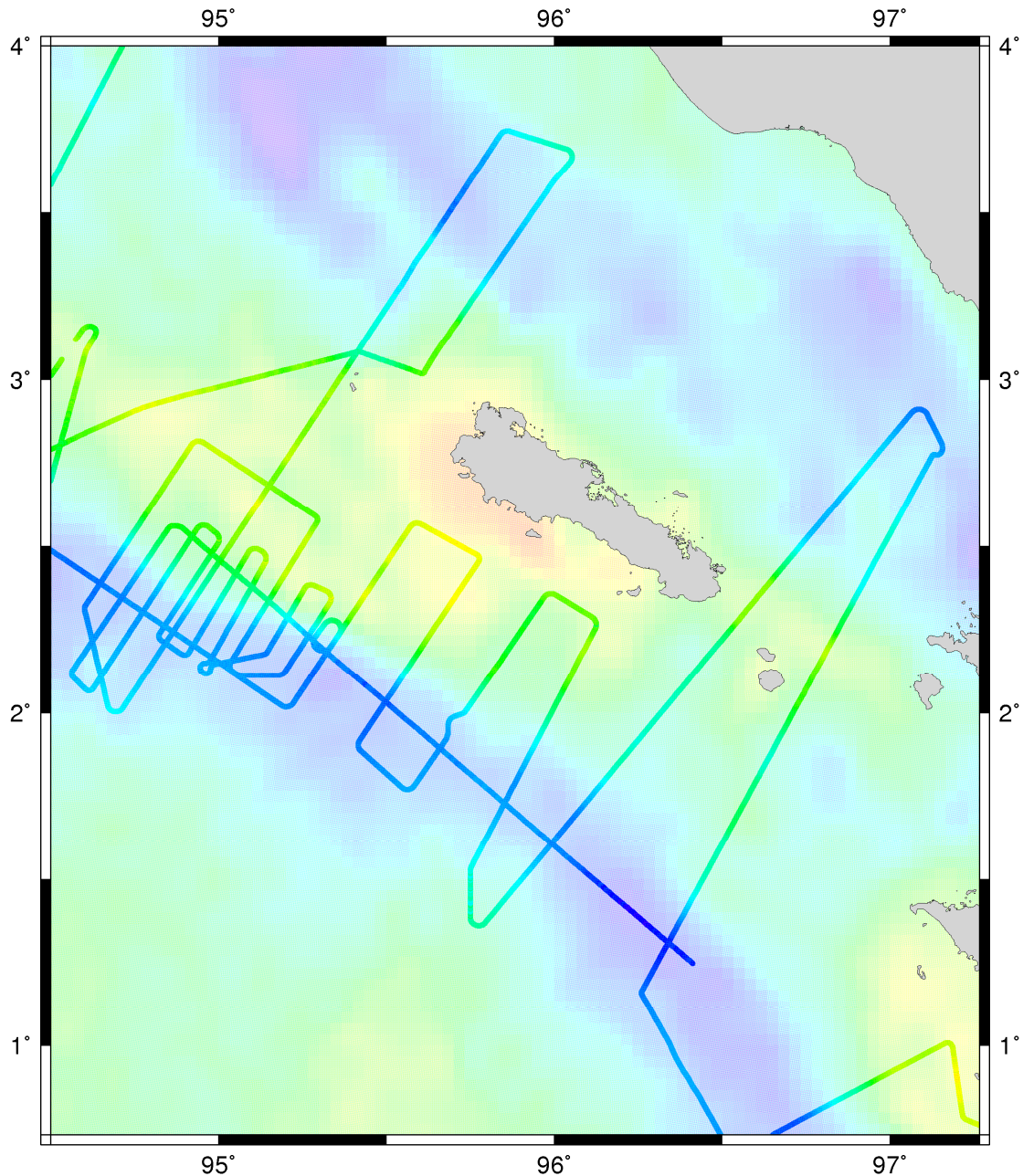

Figure 109: Gravity anomaly calculated from the 1-minute data for Survey Box 1. The background grid is from Sandwell and Smith (1997).

Magnetic data

Magnetic data were acquired during airgun shooting. The magnetometer was turned off and brought close to the ship during the short transit from Survey Box 1 while the streamer was partially recovered to add weight and replace a bird; when an 'O'-ring in the main tow connector failed on Julian Day 194; and when the airguns were recovered on Julian Day 197 to effect repairs and remove the tangled remains of a fishing net. Data acquired are summarised in Table 23 and plotted in Figure 110.

File (.mag & .XYZ)	Start				End			
	Julian Day	UTC Time	Lat.	Long.	Julian Day	UTC Time	Lat.	Long.
sl_data_so198_2_011	193	02:02:56	1.019	96.337	193	02:03:01	1.019	96.337

sl_data_so198_2_012	193	02:03:39	1.020	96.336	194	03:52:01	2.909	97.076
sl_data_so198_2_013	194	04:38:00	2.859	97.030	197	02:12:31	2.021	95.190
sl_data_so198_2_014	197	04:57:16	2.104	95.068	199	14:37:37	3.154	95.698

Table 23: Details of the files of magnetics data acquired during the MCS survey in Survey Box 1. Locations are for the ship.

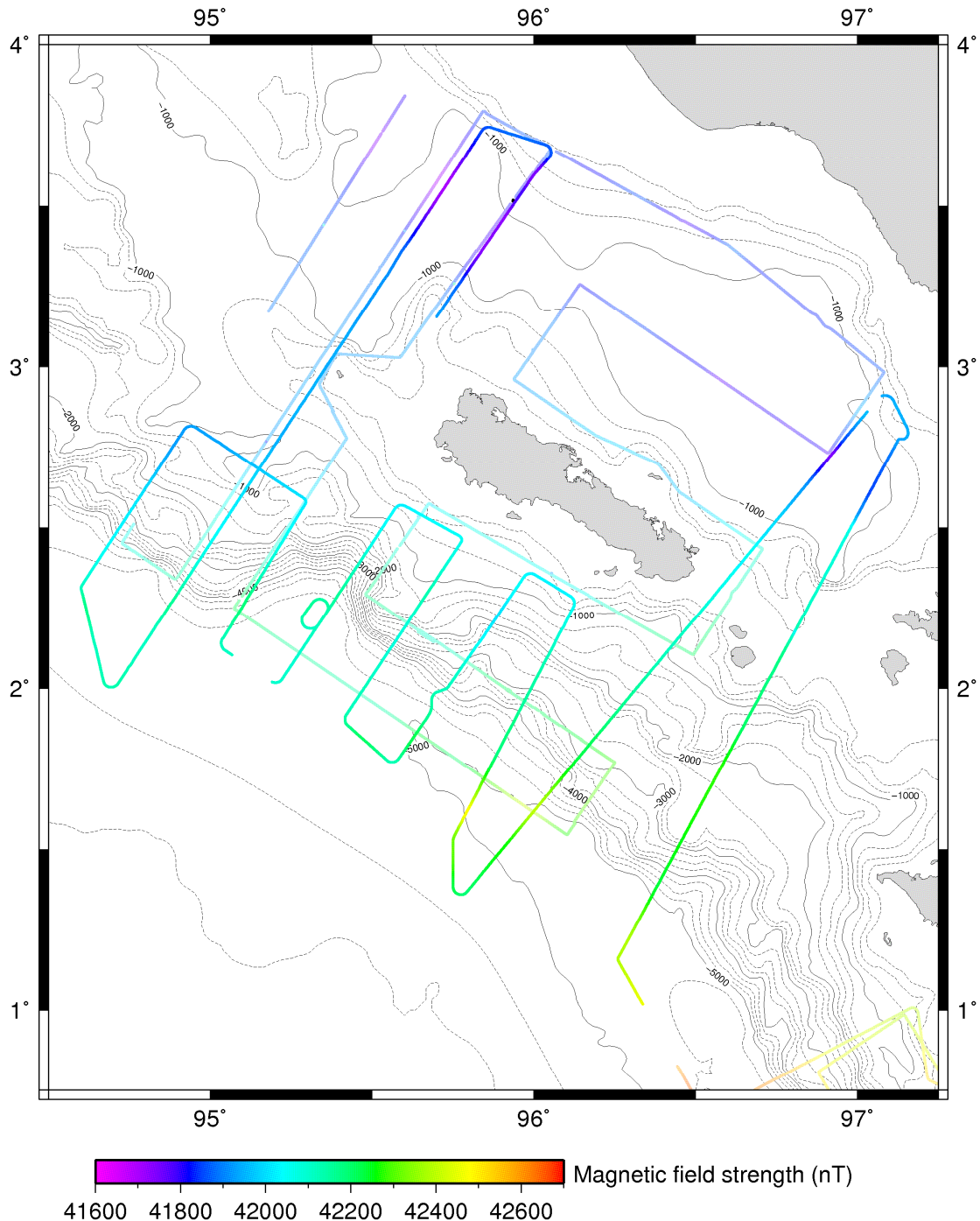

Figure 110: Magnetic field strength in nT measured during the MCS survey in Survey Box 1. Gaps in the data occur during the short transit from Survey Box 1, when an 'O'-ring in the main tow connector failed on Julian Day 194, and the airguns were recovered on Julian Day 197 to effect repairs and remove tangled fishing net. Earlier profiles from SO198-1/2 are coloured faintly. GEBCO 1-minute bathymetry is contoured every 250 m.

Results: UTIG Survey (18th – 24th July)

Goals for the UTIG portion of SO198-2 include imaging the deformation front and décollement at multiple locations within our study area, mapping structures within the accretionary prism, and the studying Aceh forearc basin and West Andaman fault that bounds it. Through imaging these structures, these profiles should allow us to look for potential rupture pathways beneath or through the upper plate that might influence tsunami generation, examine the interrelationship and geohazards implications between compressional forearc strain and strike-slip deformation in this highly oblique margin, and map key unconformities in piggyback basins and the Aceh forearc basin for insights into the geologic history of the margin.

Survey narrative

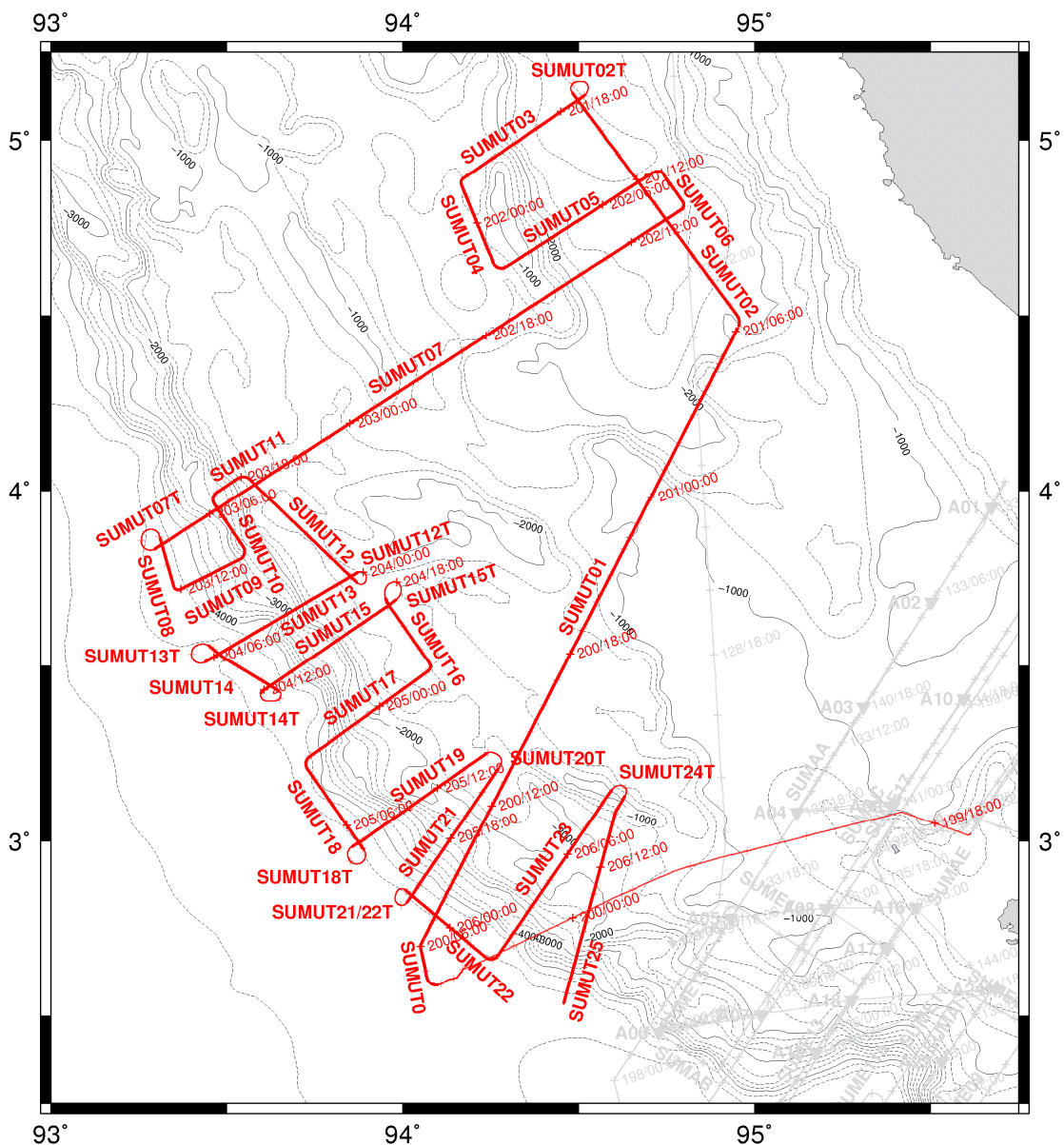

Figure 111: Map of SUMUT survey tracks. Crosses indicate the position each hour and every 6 hours is labelled with Julian Day and UTC time. Swath and *Parasound* data

were acquired continuously; bold lines identify multichannel seismic (MCS) profiles SUMUT0-SUMUT25. GEBCO 1-minute bathymetry is contoured every 250 m.

Julian Day 200, Thursday 18th July

Transit overnight to start of UT survey, through winds that reach a sustained 20 m/s for a short period. Arrive 3 nm from the start waypoint at 09:00. Deploy the streamer and guns by 11:00. Start heading towards line SUMUT01 and decide to go ahead and start recording the transit as SUMUT0. Line SUMUT0 starts at 11:11:50. Due to reduced penetration on the Seal quality control displays, a check is made that all the guns are firing, which takes from 12:01:30 to 12:10:10. All guns were firing. Line SUMUT0 is completed at 13:16:30. Line SUMUT01 starts at 13:21:10. Some following sea type noise and sea state based noises were observed throughout the day although the problem general lessened as the day went on and was not acute during the night. Noise was mitigated through speed changes to keep streamer flat as possible. During the night streamer was put at 12 m in an attempt to isolate it from the swell noise.

Julian Day 201, Thursday 19th July

Continuation of line SUMUT01. The streamer is raised to 10 m at 06:00 in preparation for imaging the forearc basin. Line SUMUT01 is completed at 13:09:50 and line SUMUT02 started at 13:13:10. The weather picked up in the evening, reaching sea state 8. The data is quite noisy. The streamer is kept at 10 m due to concerns over notch frequencies, but then lowered near the end of line SUMUT02 as the centre part of streamer would not stay down. Line SUMUT02 is completed at 22:38:30 and followed by an outside “pig’s ear” turn. There is some concern that due to the sea state the starboard guns were going to cross the streamer, but the turn was taken gradually enough that this did not happen.

Julian Day 202, Thursday 20th July

Started line SUMUT03 at 00:00:30 and ended it at 05:17:10 with an inside turn onto SUMUT04. Line SUMUT04 was acquired from 05:19:10 to 08:32:30 with an inside turn onto SUMUT05. Line SUMUT05 headed back into the forearc basin and lasted from 08:35:30 to 15:04:30 with an inside turn onto a short SUMUT06. Line SUMUT06 was acquired from 15:08 to 16:39 with an inside turn onto SUMUT07. Line SUMUT07 is the other long line of the NSF survey, and was started at 16:41. The weather was so-so through all of the day’s shooting.

Julian Day 203, Thursday 21st July

Completed line SUMUT07 at 15:18. The weather steadily improved as we progressed down line SUMUT07. We did an outside turn between line SUMUT07 and SUMUT08 and maintenance was performed on the NMF compressor during this turn to drain off condensation and add oil. Line SUMUT08 started at 17:04 and ended at 18:42, from which an inside turn took us to line SUMUT09, which crossed the deformation front and was acquired from 18:45 to 21:11. Another inside turn was taken to line SUMUT10 that runs parallel to the margin. The end point of SUMUT10 was moved to the east-northeast in order to be certain that the line crossed BGR line 105 at the

correct water depth for one of the possible IODP drill sites. Line SUMUT10 was acquired from 21:15 to 23:32. An inside turn was made onto line SUMUT11, which started at 23:35.

Julian Day 204, Thursday 22nd July

Line SUMUT11 was completed at 00:52 and followed by an inside turn onto SUMUT12. Line SUMUT12, oriented parallel to the margin, was acquired from 00:54 to 06:17 and followed by an outside turn that took only 1 hour to complete. Line SUMUT13, heading seaward, back toward the trench, was started at 07:12; SUMUT13 was completed at 13:20 and followed by an outside turn, recorded as SUMUT13T, that ended at 14:40 with start of line SUMUT14 at 14:53. Line SUMUT14 was completed at 17:43 with another outside turn, recorded as SUMUT14T, which was acquired from 17:43 to 18:48 and followed by the start of line SUMUT15. Both the outside turns SUMUT13T and SUMUT14T allowed for line crossings at potential future scientific drill sites. There was some rain during the night but the weather, in general, remained pleasant.

Julian Day 205, Thursday 23rd July

Line SUMUT15 was completed just after midnight, at 00:20, and was followed by an outside turn to generate another line crossing. This outside turn was recorded as SUMUT15T, and was acquired from 00:21 to 01:49. Following this turn we recorded line SUMUT16 from 01:51 to 04:36, and followed this line by an inside turn onto SUMUT17, starting this line at 04:38. Line SUMUT17 was completed at 10:05 with an inside turn onto SUMUT18. A calculation suggested that we are currently over 5 hours ahead of schedule and thus the end of line SUMUT18 was changed to an outside turn. After consultation with the Bridge, line SUMUT20 is determined to be too short to be driven as a straight profile, and thus will be called SUMUT20T, to be driven as a curve connecting lines SUMUT19 with SUMUT21. Line SUMUT18 is completed was at 14:03 and followed by an outside turn onto SUMUT19, which took until 15:35. Line SUMUT19 was completed at 20:57 and followed by the turning line SUMUT20T. The turn ended at 22:01 with the start of line SUMUT21 at 22:03.

Julian Day 206, Thursday 24th July

Line SUMUT21 was completed at 03:45 and followed by an outside “pig’s ear” turn that was completed at 04:54. Note that in the logbooks this turn is called SUMUT21T, but the data was record as SUMUT22T. Line SUMUT22 started at 04:55 and was completed at 08:43, at the start line of SUMUT23. A calculation suggested that we are roughly 3 hours ahead of schedule, so we decided to image across the ridge feature north of waypoints beyond the planned end of line SUMUT23. To accomplish this we extended line SUMUT23 by 7 nautical miles along track to the northeast, and extended SUMUT25 by 6 nautical miles along track to the northwest. The actual end of line SUMUT23 did not occur exactly on the waypoint but rather was delayed by ~15 minutes. The single trace display was watched to ensure that the sub-1000 m ridge was crossed completely before starting to turn at 15:27. The inside turn between lines SUMUT23 and SUMUT25 was record as SUMUT24T. Line SUMUT25 started at 16:16. In order to link the following

survey to the current SUMUT survey efficiently the original start and end waypoints for each survey moved to the same position, ~1 nautical mile northeast of the planned position for the end of line SUMUT25; line SUMUT25 was thus completed at 23:54.

Seismic source

Start			End			Shot Int. (s)	Line/comment
Julian Day	UTC Time	Longshot No.	Julian Day	UTC Time	Longshot No.		
200	04:11:50	58234	200	06:16:30	58608	20	SUMUT0
200	06:21:10	58623	201	06:09:50	62909	20	SUMUT01
201	06:13:10	62919	201	15:38:30	64615	20	SUMUT02
201	16:59:30	64856	201	22:17:10	65811	20	SUMUT03
201	22:19:10	65816	202	01:32:50	66397	20	SUMUT04
202	01:35:30	66405	202	08:04:30	67572	20	SUMUT05
202	07:01:00						Pressure < 125 bars
202	07:09:00						Compressors fixed
202	07:11:15	67415					Gun 7 disabled
202	07:16:00						Gun 7 reenabled
202	08:08:30	67585	202	09:39:10	67857	20	SUMUT06
202	09:41:30	67864	203	08:18:10	71934	20	SUMUT07
203	10:04:30	72252	203	11:42:50	72547	20	SUMUT08
203	11:45:30	72555	203	14:11:43	72994	20	SUMUT09
203	14:15:10	73005	203	16:32:10	73416	20	SUMUT10
203	16:35:30	73426	203	17:52:30	73657	20	SUMUT11
203	17:54:30	73662	203	23:17:30	74631	20	SUMUT12
204	00:12:30	74795	204	06:20:10	75898	20	SUMUT13
204	07:48:10	76164	204	10:39:10	76677	20	SUMUT14
204	11:51:30	76893	204	17:20:30	77880	20	SUMUT15
204	18:51:50	78155	204	21:36:50	78650	20	SUMUT16
204	21:38:30	78655	205	03:05:30	79636	20	SUMUT17
205	03:06:50	79640	205	07:03:30	80350	20	SUMUT18
205	08:35:30	80626	205	13:57:30	81592	20	SUMUT19
205	15:03:30	81769	205	20:45:50	82796	20	SUMUT21
205	21:55:50	83005	206	01:43:50	83689	20	SUMUT22
206	01:46:30	83697	206	08:27:50	84901	20	SUMUT23
206	09:19:10	85056	206	16:54:50	86423	20	SUMUT25

Table 24: Log of the airgun shooting interval and *LongShot* number versus the start and end times for each MCS line, as recorded by the watch keeper.

Multichannel seismic reflection data

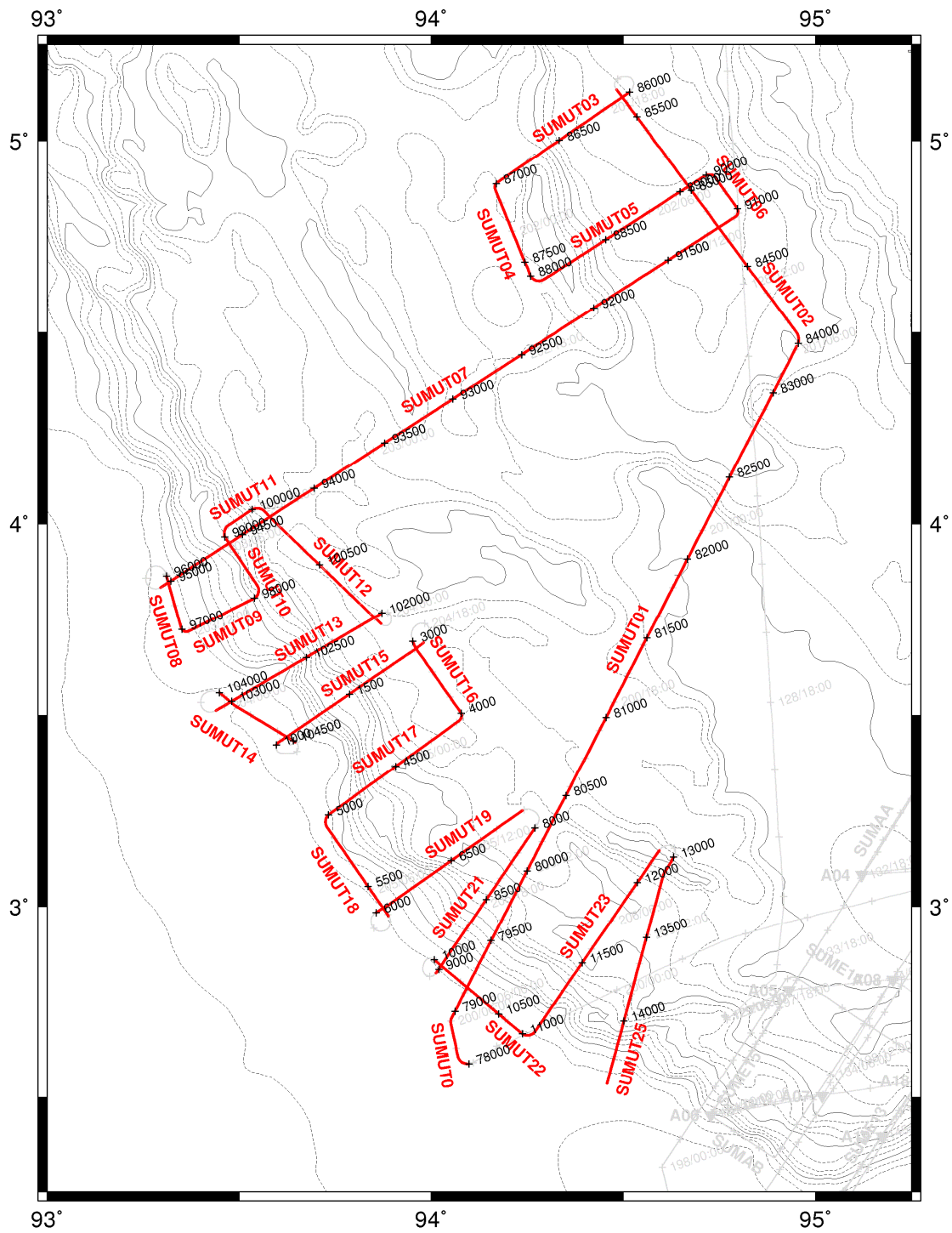

Figure 112: Shot point (FFID) map for multichannel seismic (MCS) profiles SUMUT0-SUMUT25. Black crosses identify every 500 FFIDs. GEBCO 1-minute bathymetry is contoured every 250 m.

Line	Start					End				
	Julian Day	Sercel Time	FFID No.	Lat.	Long.	Julian Day	Sercel Time	FFID No.	Lat.	Long.
SUMUT0	200	04:11:29	78000	2.589	94.098	200	06:16:09	78374	2.721	94.059
SUMUT01	200	06:20:49	79000	2.726	94.062	201	06:06:49	83278	4.463	94.951

SUMUT02	201	06:12:48	84000	4.471	94.955	201	15:38:08	85696	5.133	94.482
SUMUT03	201	16:59:08	86000	5.127	94.516	201	22:16:48	86951	4.889	94.170
SUMUT04	201	22:18:48	87000	4.887	94.168	202	01:32:28	87581	4.649	94.257
SUMUT05	202	01:35:08	88000	4.647	94.258	202	08:04:08	89167	4.907	94.711
SUMUT06	202	08:08:08	90000	4.909	94.716	202	09:38:48	90272	4.824	94.795
SUMUT07	202	09:41:08	91000	4.821	94.797	203	08:17:47	95070	3.834	93.295
SUMUT08	203	10:04:07	96000	3.863	93.311	203	11:42:27	96295	3.727	93.349
SUMUT09	203	11:45:07	97000	3.724	93.351	203	14:11:27	97439	3.804	93.536
SUMUT10	203	14:14:47	98000	3.806	93.540	203	16:31:47	98411	3.962	93.465
SUMUT11	203	16:35:07	99000	3.966	93.462	203	17:52:07	99231	4.035	93.531
SUMUT12	203	17:54:07	100000	4.036	93.533	203	23:17:07	100969	3.738	93.869
SUMUT13	204	00:12:07	102000	3.767	93.871	204	06:19:47	103103	3.512	93.439
SUMUT14	204	07:47:47	104000	3.558	93.448	204	10:38:47	104513	3.430	93.645
SUMUT15	204	11:51:07	1000	3.422	93.597	204	17:20:06	1987	3.689	93.980
SUMUT16	204	18:50:46	3000	3.692	93.951	204	21:36:27	3496	3.507	94.076
SUMUT17	204	21:38:06	4000	3.505	94.077	205	03:05:06	4981	3.240	93.733
SUMUT18	205	03:06:26	5000	3.239	93.732	205	07:03:06	5710	2.975	93.889
SUMUT19	205	08:35:06	6000	2.984	93.856	205	13:57:06	6966	3.250	94.237
SUMUT21	205	15:03:06	8000	3.205	94.270	205	20:45:26	9027	2.825	94.012
SUMUT22	205	21:55:26	10000	2.860	94.007	206	01:43:26	10684	2.669	94.234
SUMUT23	206	01:46:06	11000	2.667	94.237	206	08:27:26	12204	3.146	94.593
SUMUT25	206	09:18:45	13000	3.129	94.630	206	16:54:25	14367	2.536	94.457

Table 25: Start and end times, FFID numbers and locations for multichannel seismic (MCS) lines SUMUT0-SUMUT25, excluding turns. Times are extracted from the SEG-D headers and represent the system time on the Sercel, not UTC, although the clock was synchronised to UTC at the start of the experiment and is therefore correct to seconds.

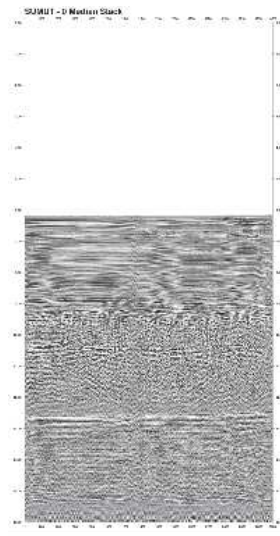

Figure 113: Stacked multichannel seismic section for profile SUMUT0.

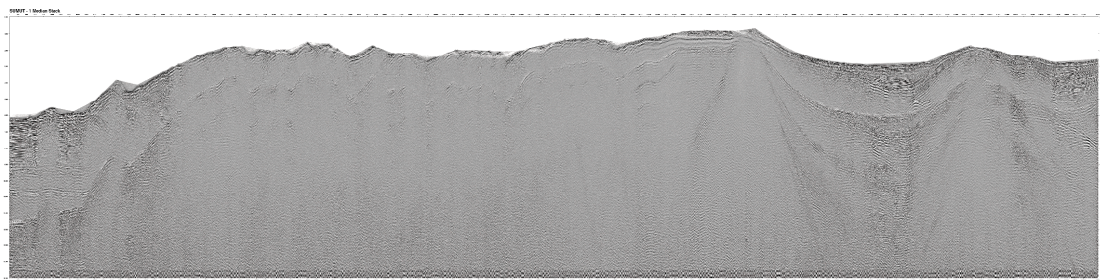

Figure 114: Stacked multichannel seismic section for profile SUMUT01.

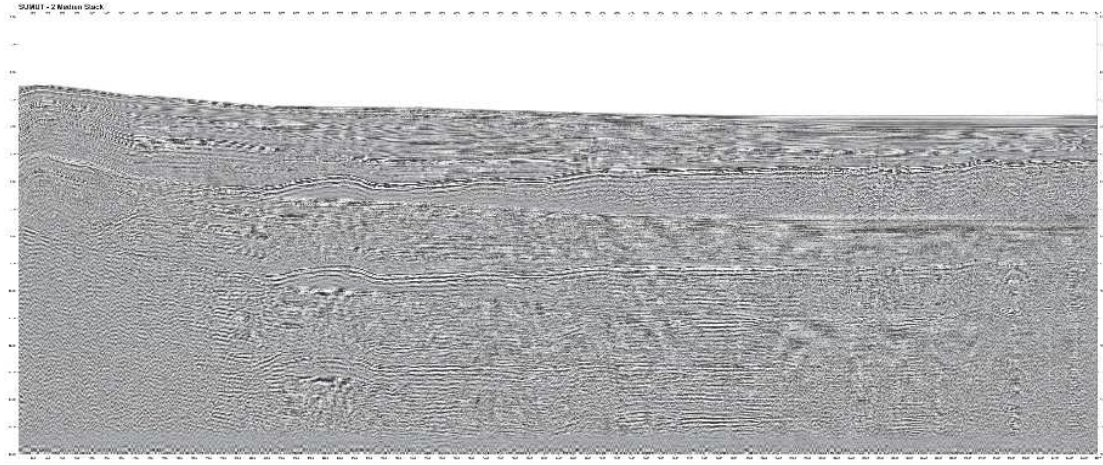

Figure 115: Stacked multichannel seismic section for profile SUMUT02.

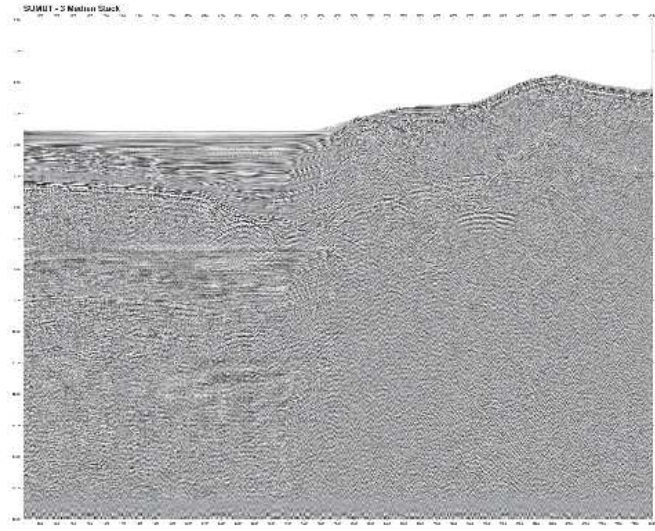

Figure 116: Stacked multichannel seismic section for profile SUMUT03.

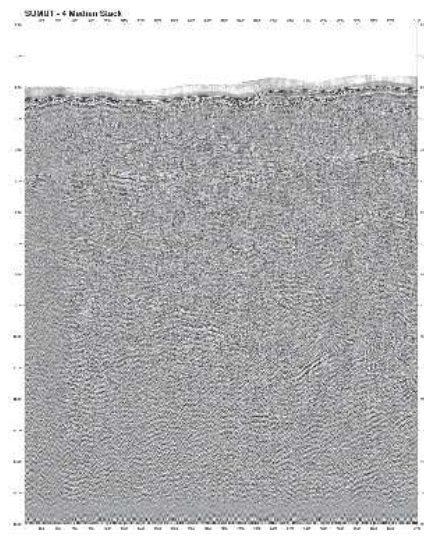

Figure 117: Stacked multichannel seismic section for profile SUMUT04.

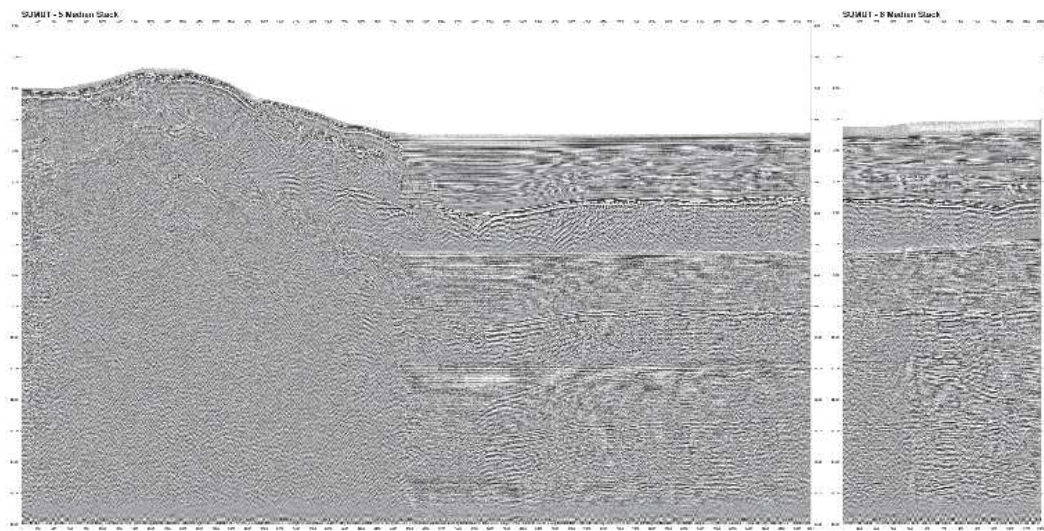

Figure 118: Stacked multichannel seismic sections for profile SUMUT05 (left) and SUMUT06 (right).

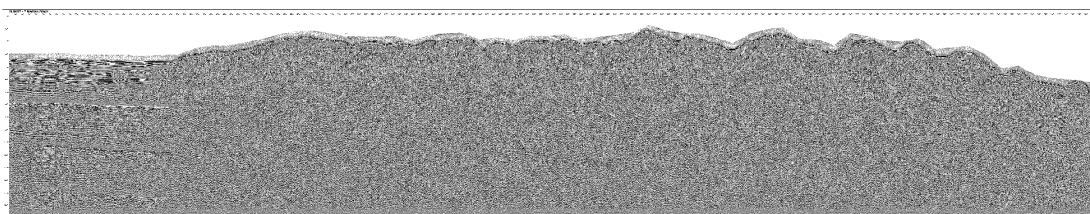

Figure 119: Stacked multichannel seismic section for profile SUMUT07.

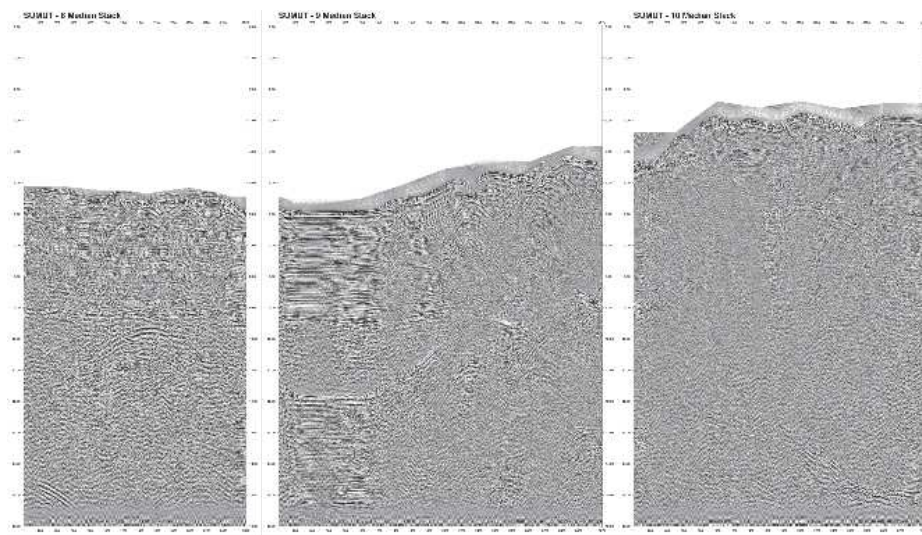

Figure 120: Stacked multichannel seismic sections for profile SUMUT08 (left), SUMUT09 (centre) and SUMUT10 (right).

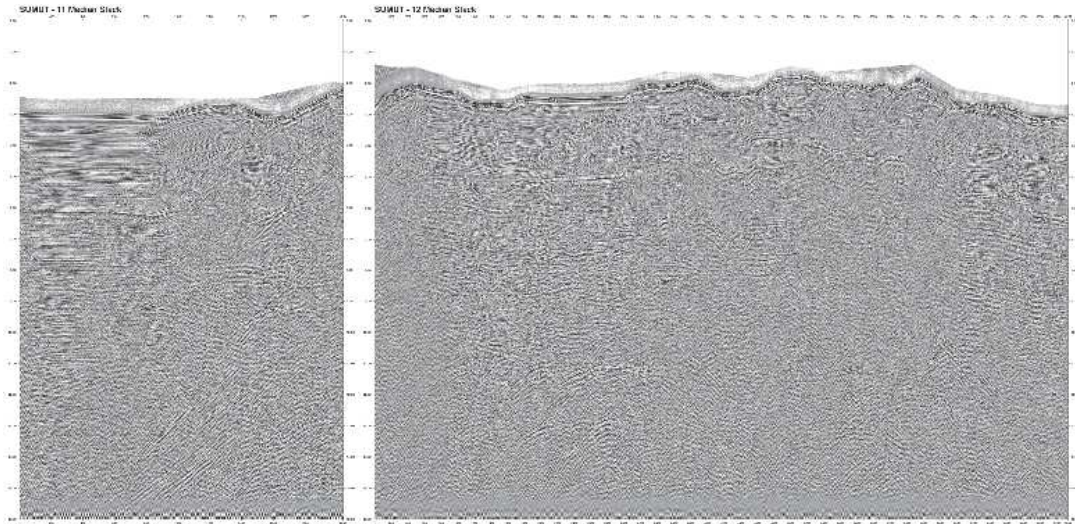

Figure 121: Stacked multichannel seismic sections for profile SUMUT11 (left) and SUMUT12 (right).

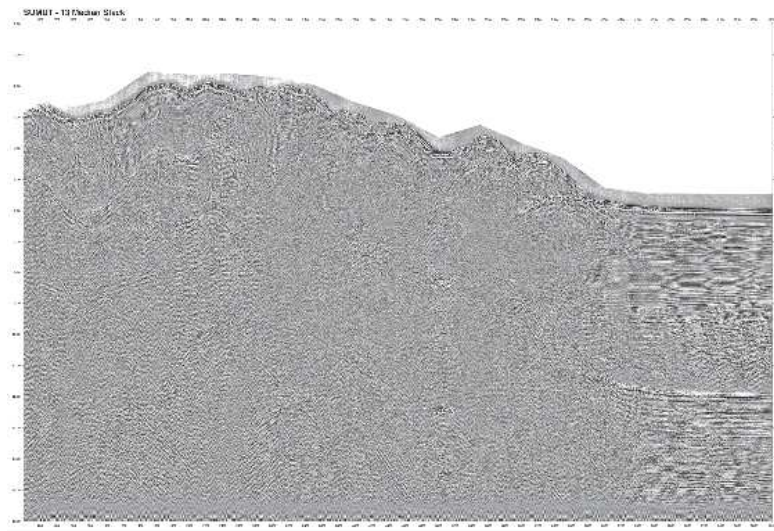

Figure 122: Stacked multichannel seismic section for profile SUMUT13.

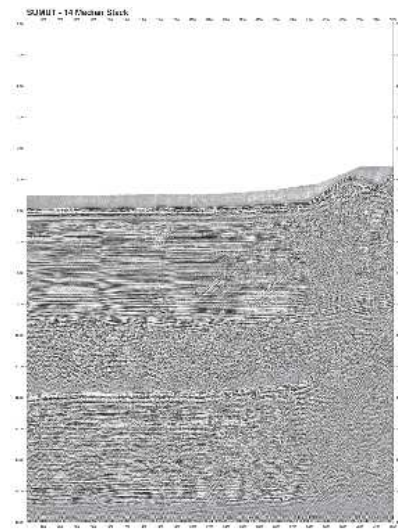

Figure 123: Stacked multichannel seismic section for profile SUMUT14.

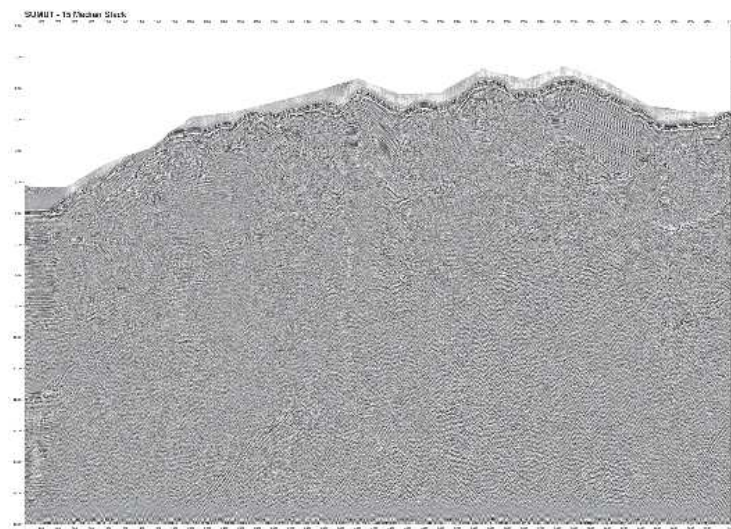

Figure 124: Stacked multichannel seismic section for profile SUMUT15.

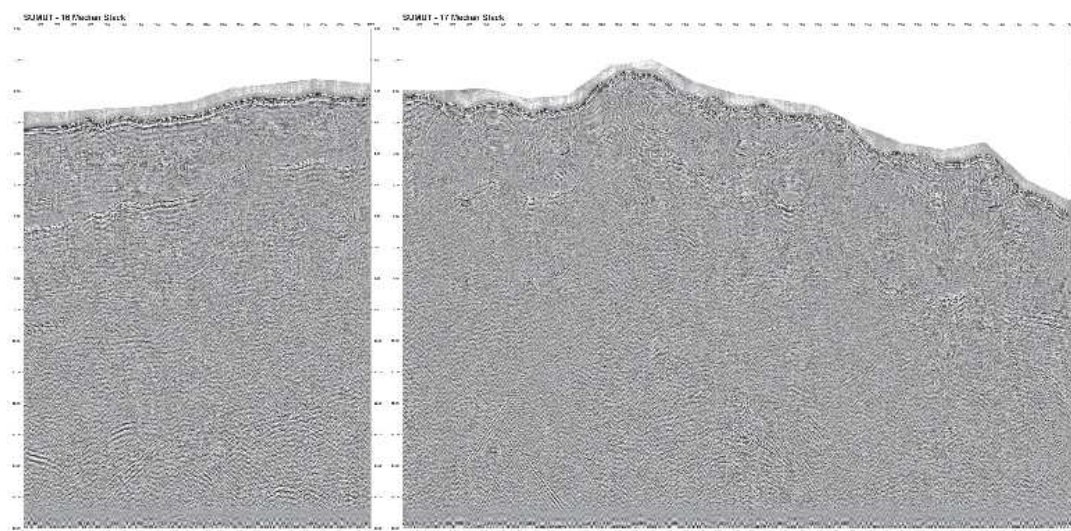

Figure 125: Stacked multichannel seismic sections for profile SUMUT16 (left) and SUMUT17 (right).

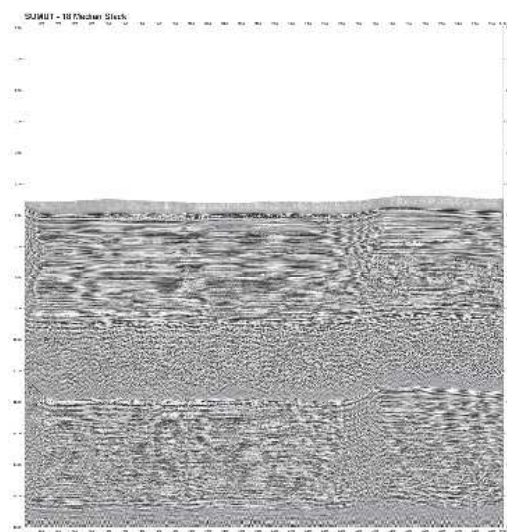

Figure 126: Stacked multichannel seismic section for profile SUMUT18.

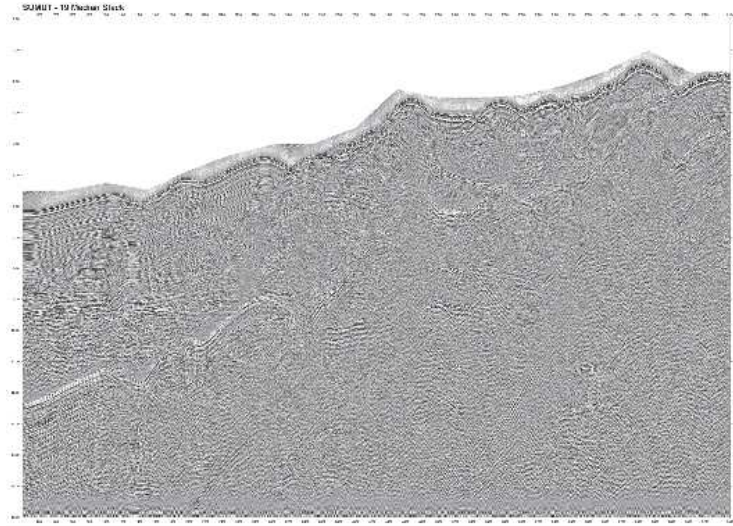

Figure 127: Stacked multichannel seismic section for profile SUMUT19.

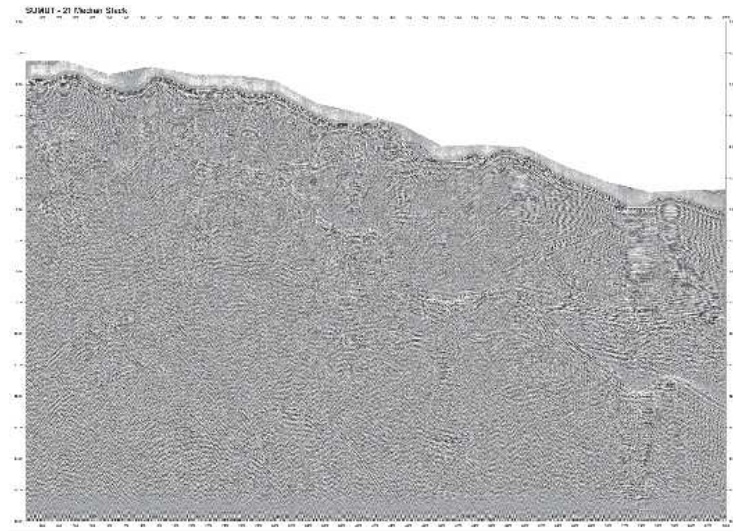

Figure 128: Stacked multichannel seismic section for profile SUMUT21.

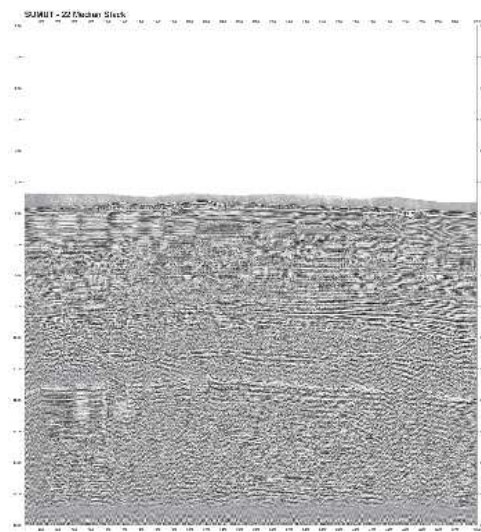

Figure 129: Stacked multichannel seismic section for profile SUMUT22.

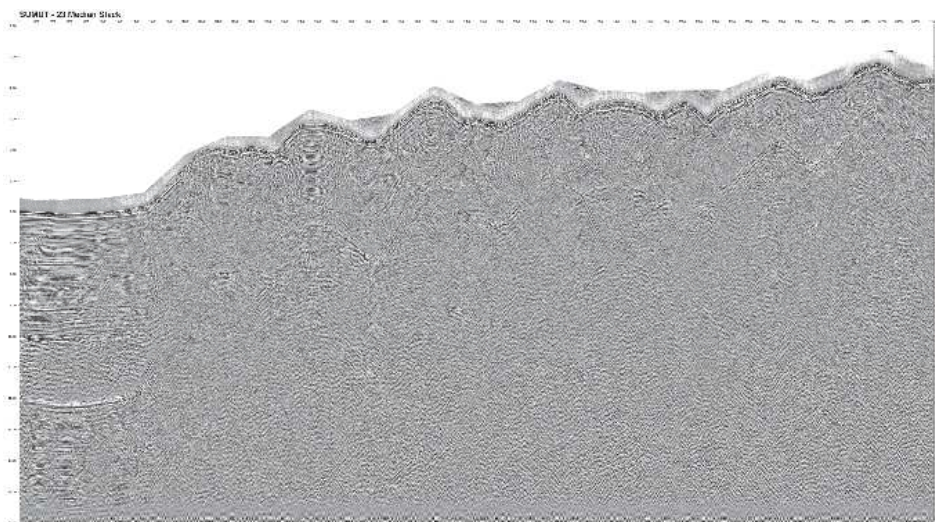

Figure 130: Stacked multichannel seismic section for profile SUMUT23.

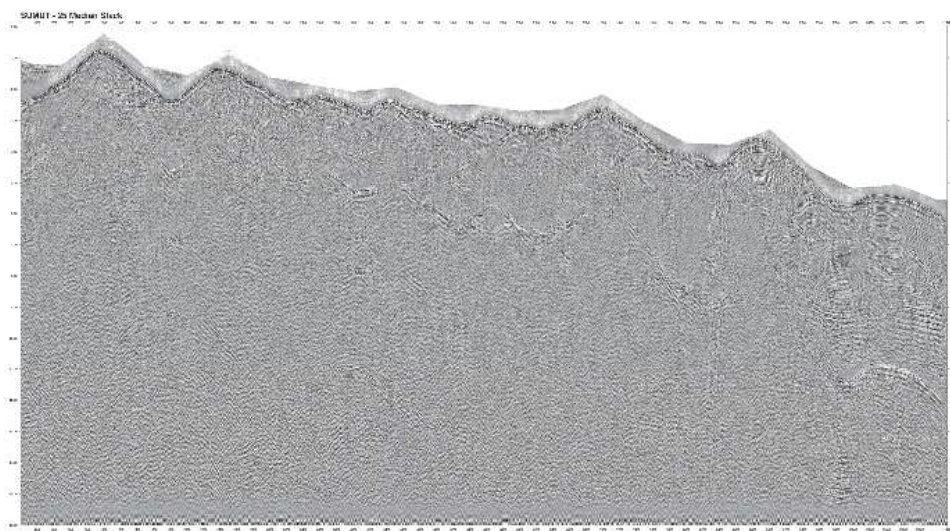

Figure 131: Stacked multichannel seismic section for profile SUMUT25.

Swath bathymetry

Swath bathymetric data were acquired continually during the SUMUT MCS survey (Figure 132)

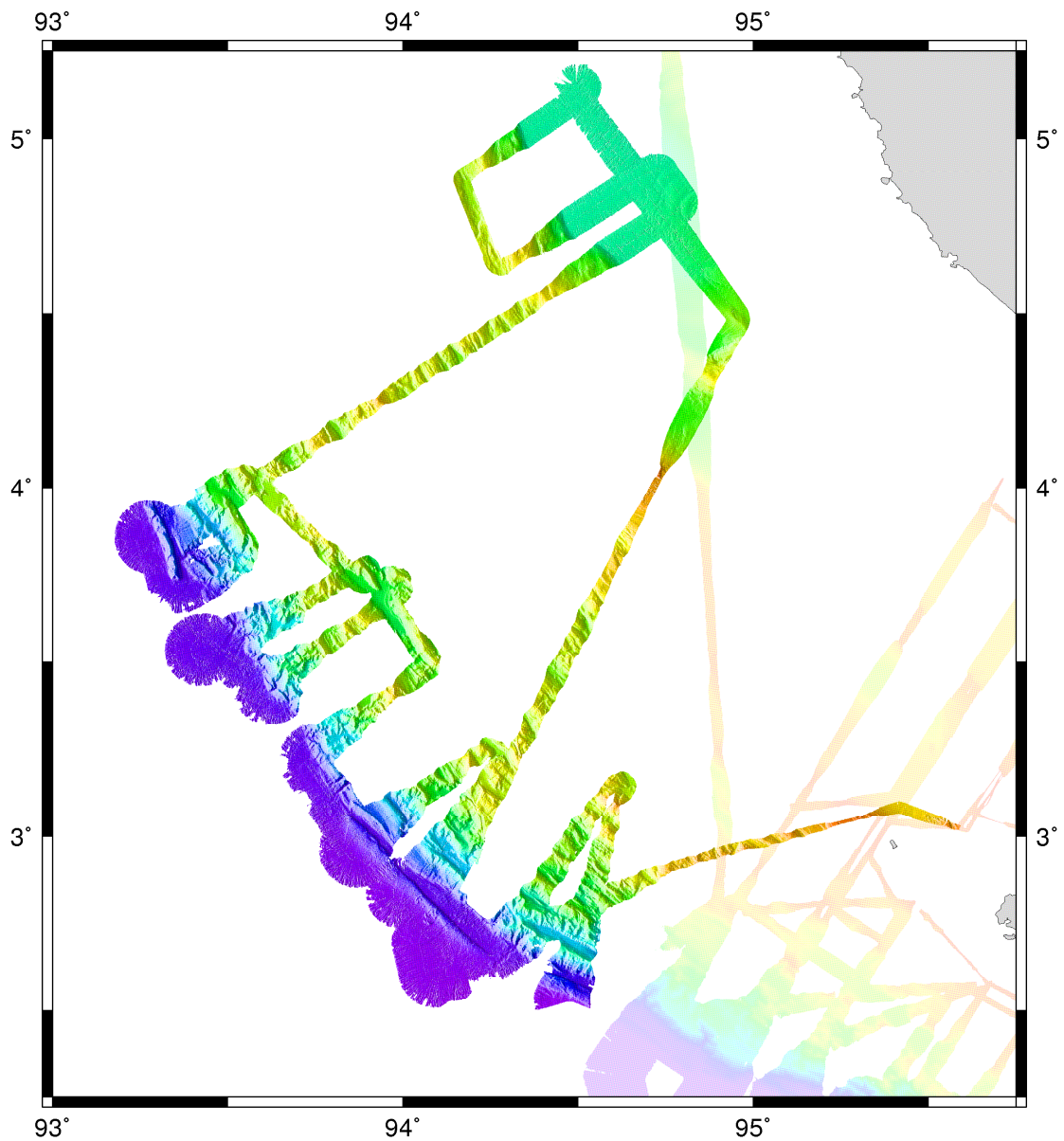

Figure 132: Raw swath bathymetric data acquired during the UTIG MCS survey. The data were gridded using Caris software. Illumination is from the south-west. Data from SO198-1 and earlier in SO198-2 are shown in the background.

Gravity data

Data from the gravity data, logged at 1-minute intervals on the laptop in the gravity meter room, were corrected for the drift of the meter's clock and reduced to give the gravity anomaly (see Explanatory Notes). The results acquired during the SUMUT MCS survey are shown in Figure 133.

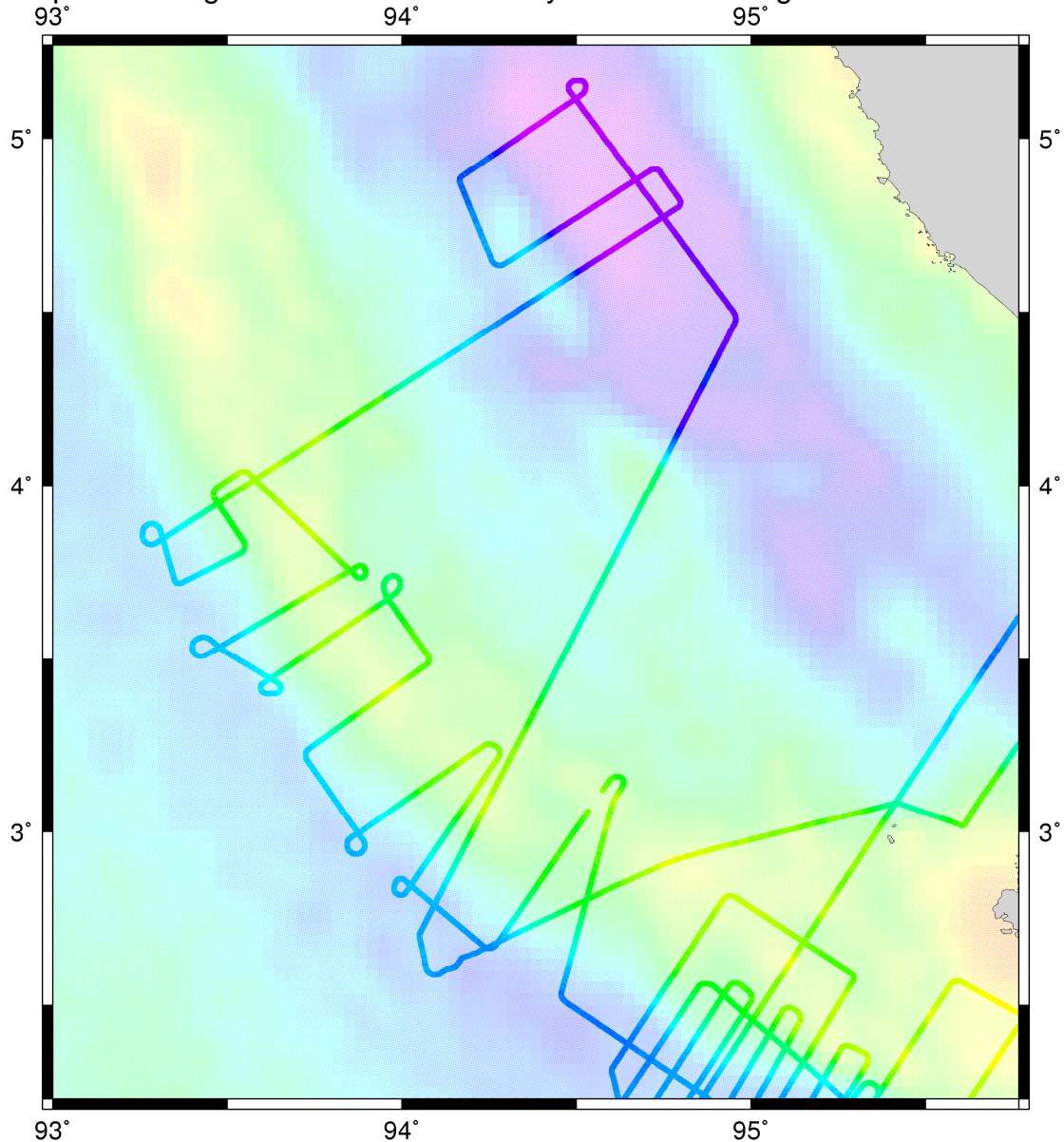

Figure 133: Gravity anomaly calculated from the 1-minute data acquired during the SUMUT MCS survey. The background grid is from Sandwell and Smith (1997).

Parasound data

Parasound data were acquired continually during the SUMUT MCS survey (Figure 134).



Figure 134: Location of the *Parasound* sub-bottom profiler data acquired during the SUMUT MCS survey. Earlier profiles from SO198-1/2 are coloured faint red.

Magnetic data

Magnetic data were acquired continuously during airgun shooting. Data acquired are summarised in Table 26 and plotted in Figure 135.

File (.mag & .XYZ)	Start				End			
	Julian Day	UTC Time	Lat.	Long.	Julian Day	UTC Time	Lat.	Long.
sl_data_so198_2_015	No data							
sl_data_so198_2_016	200	05:53:03	2.692	94.051	203	04:35:54	4.090	93.660
sl_data_so198_2_017	203	04:35:55	4.090	93.660	205	04:01:50	3.229	93.732
sl_data_so198_2_018	205	04:01:51	3.229	93.732	206	04:01:54	2.813	94.265
sl_data_so198_2_019	206	04:01:55	2.858	94.289	206	16:54:00	2.605	94.423

Table 26: Details of the files of magnetics data acquired during the SUMUT MCS survey. Locations are for the ship.

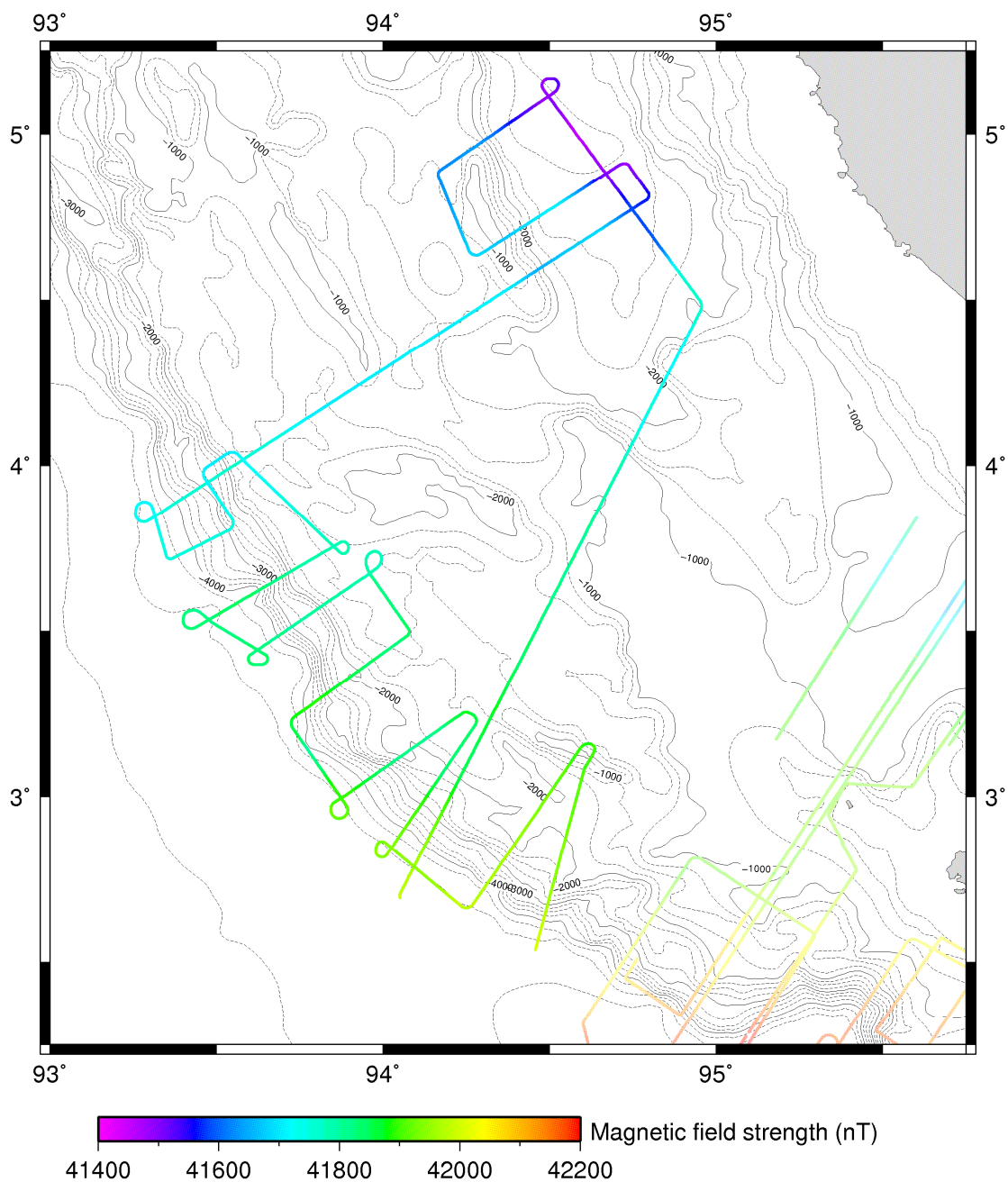

Figure 135: Magnetic field strength in nT measured during the SUMUT MCS survey. Earlier profiles from SO198-1/2 are coloured faintly. GEBCO 1-minute bathymetry is contoured every 250 m.

Results: High-resolution survey and strike lines (25th – 31st July)

Survey narrative

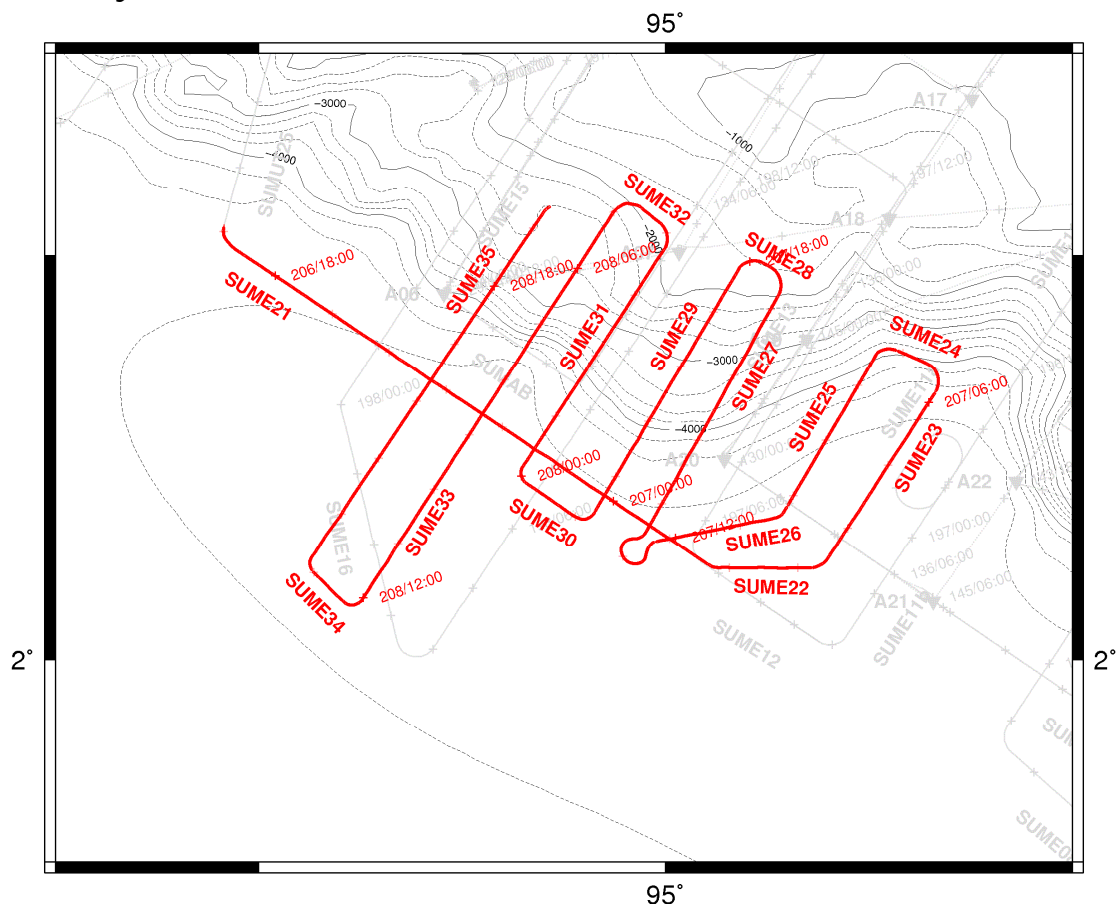

Figure 136: Map of the new SUME survey tracks in Survey Box 1. Crosses indicate the position each hour and every 6 hours is labelled with Julian Day and UTC time. Swath and Parasound data were acquired continuously. GEBCO 1-minute bathymetry is contoured every 250 m.

Julian Day 207, Thursday 25th July

The seismic reflection survey in Survey Box 1 continues with a detailed study of the transition identified around SUME13, SUME15 and SUME17. Based on our previous experience, we shot a strike line on the oceanic plate southward and then a series of dip lines heading northward along the margin. We completed SUME21 (colinear with SUME12) at 08:40, SUME22 at 09:12, SUME23 at 13:09, SUME24 at 14:04, SUME25 at 17:10, and SUME26 at 19:17 with an outside turn to ensure that we completed two ties with SUME21. Conditions were excellent throughout and noise levels generally low, although we still are subject to a 1kt current seaward across the margin and a slightly confused long-wavelength swell. A timetable for the remaining acquisition is discussed with the Master.

Julian Day 208, Thursday 26th July

We continue the detailed seismic reflection survey in Survey Box 1. Sea conditions are excellent – minimal local wind and the background swell is still reducing – although the cross-margin currents still cause some problems. We complete lines SUME27 at 00:12, SUME28 at 00:47, SUME29 at 05:37, SUME30 at 06:52, SUME31 at 10:45, SUME32 at 11:31, SUME33 at 19:03, SUME34 at 20:01. Today is SP's birthday and a party is held in the evening.

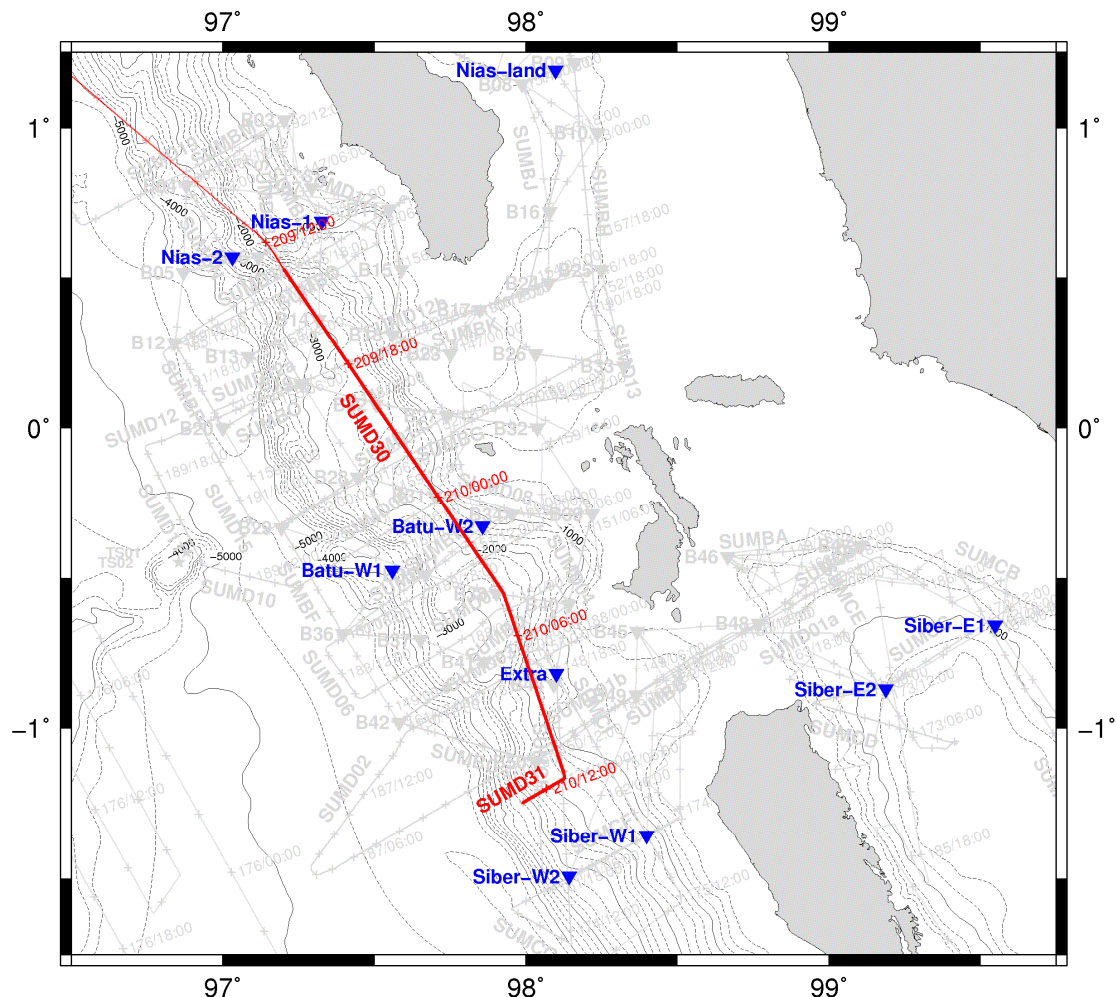

Figure 137: Map of the new SUMD survey tracks in Survey Box 2. Crosses indicate the position each hour and every 6 hours is labelled with Julian Day and UTC time. Swath and *Parasound* data were acquired continuously. Blue triangles locate long-term ocean-bottom seismometers (OBS) deployed during SO198-1. GEBCO 1-minute bathymetry is contoured every 250 m.

Julian Day 209, Thursday 27th July

We complete the detailed seismic reflection survey in Survey Box 1, finishing line SUME35 at 02:23. The overall average speed for the survey is 5.1 kt. Once past the waypoint, we bring the magnetometer alongside, turn to starboard and begin to recover the seismic gear. Starboard guns are on board at 02:44. A problem develops with the port side winch during the recovery, and because sea conditions are so benign we start to bring in the streamer while the gun winch is repaired. All the equipment is on board by 04:35. As we start to transit south to shoot a strike line at Survey Box 2 we take the rare

opportunity to launch an XBT, and redeploy the magnetometer. Sea conditions during the transit are the best we have seen since leaving Merak – glassy with only a very slight swell – and we make excellent time. We arrive at the waypoint, launch an XBT and begin deploying the streamer at 18:30, which is completed at 19:45. The guns are in the water at 20:10, and we reach the start of line SUMD30 at 13:40.

Julian Day 210, Thursday 28th July

We continue the strike line SUMD30 throughout the day. Conditions for seismic acquisition remain close to perfect and low noise levels and a tail current mean that we average 5.3kt along the line. The point at which the line changes trend is reached at 11:16, and the end of line at 18:06. We then run parallel to line SUMD01 until the end of survey. The magnetometer is brought on board (once again with a failed 'O'-ring) at 20:00 and TH switches off the guns at 20:05 after shot number 99754. The starboard side guns are recovered at 20:20, and the calm conditions allow the streamer recovery to start while the port side guns are brought on board. The tailbuoy is secure at 21:30 and we commence passage back to port.

Julian Day 211, Thursday 29th July

We continue passage to Merak. Regular scientific watchstanding ceases when the *Parasound* and swath systems are stopped before we leave the survey box at 06:55. As we travel south the swell from the Southern Ocean reaches more typical levels again.

Julian Day 212, Thursday 30th July

We continue passage to Merak.

Seismic source

Start			End			Shot Int. (s)	Line/comment
Julian Day	UTC Time	Longshot No.	Julian Day	UTC Time	Longshot No.		
206	16:57:10	86430	207	01:40:10	87999	20	SUME21
207	01:41:50	88004	207	03:12:10	88275	20	SUME22
207	03:14:10	88281	207	06:09:10	88806	20	SUME23
207	06:11:50	88814	207	07:04:30	88972	20	SUME24
207	06:56:10	88947	207			20	Gun 3 disabled, both compressors on 0.5
207	07:00:50	88961	207	07:20:10	89019		Pressure 129 bars
207	07:07:10	88980	207	10:10:10	89529	20	SUME25
207	10:13:10	89538	207	12:16:50	89909	20	SUME26
207	12:19:50	89918	207	17:12:30	90796	20	SUME27
207	12:24:10	89931	207	12:42:10	89985	20	Testing gun combinations
207	17:13:50	90800	207	17:47:10	90900	20	SUME28
207	17:48:50	90905	207	22:37:50	91772	20	SUME29
207	22:39:50	91778	207	23:52:50	91997	20	SUME30
207	23:54:10	92001	208	03:45:50	92696	20	SUME31
208	03:47:10	92700	208	04:31:10	92832	20	SUME32
208	04:33:10	92838	208	12:01:10	94182	20	SUME33
208	12:03:30	94189	208	13:00:30	94360	20	SUME34

208	13:03:30	94369	208	19:23:30	95509	20	SUME35
209	13:27:10	95510				20	Guns 1-12 on
209	13:40:50	95551				20	Gun 4 off
209	13:40:50	95551	209	15:00:10	95789	20	Pressure
							consistently 137
							bars
209	13:40:50	95551	210	11:06:30	99408	20	SUMD30
209	15:51:10	95942				20	Guns 1-12 on
210	04:25:10	98204				20	Waypoint midline
210	11:10:10	99419	210	13:00:30	99750	20	SUMD31
210	13:02:30	99756					Guns off

Table 27: Log of the airgun shooting interval and *LongShot* number versus the start and end times for each MCS line, as recorded by the watch keeper.

Multichannel seismic reflection data

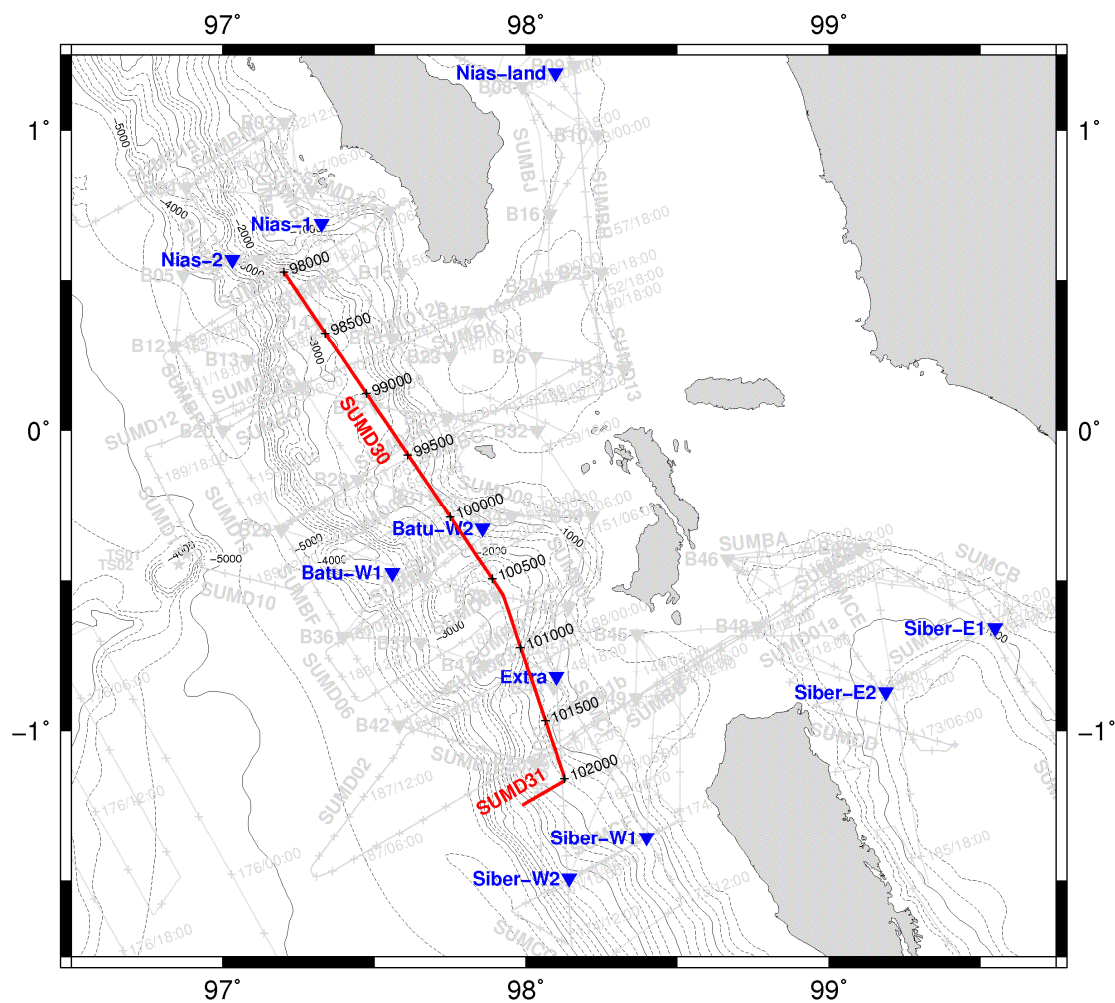

Figure 138: Shot point (FFID) map for multichannel seismic (MCS) profiles SUMD30-SUMD31. Black crosses identify every 500 FFIDs. GEBCO 1-minute bathymetry is contoured every 250 m.

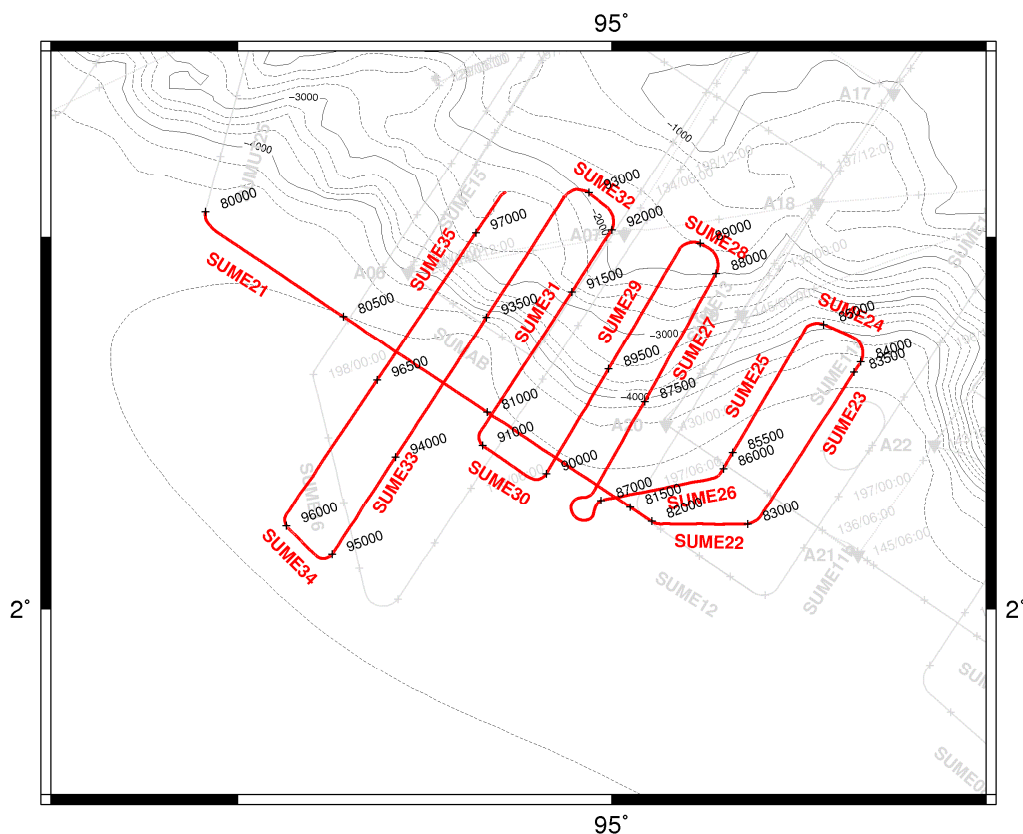

Figure 139: Shot point (FFID) map for multichannel seismic (MCS) profiles SUME21-SUME35. Black crosses identify every 500 FFIDs. GEBCO 1-minute bathymetry is contoured every 250 m.

Line	Start					End				
	Julian Day	Sercel Time	FFID No.	Lat.	Long.	Julian Day	Sercel Time	FFID No.	Lat.	Long.
SUMD30_1	209	13:40:24	98000	0.527	97.201	210	04:15:24	100625	-0.546	97.922
SUMD30_2	210	04:15:43	100626	-0.547	97.923	210	11:06:03	101857	-1.153	98.126
SUMD31	210	11:09:44	102000	-1.159	98.127	210	13:00:04	102331	-1.247	97.991
SUME21	206	16:56:45	80000	2.534	94.457	207	01:39:45	81569	2.118	95.051
SUME22	207	01:41:25	82000	2.117	95.053	207	03:11:45	82271	2.113	95.179
SUME23	207	03:13:45	83000	2.113	95.181	207	06:08:45	83525	2.329	95.330
SUME24	207	06:11:25	84000	2.332	95.332	207	07:04:05	84158	2.382	95.286
SUME25	207	07:06:45	85000	2.383	95.283	207	10:09:45	85549	2.192	95.151
SUME26	207	10:12:45	86000	2.189	95.149	207	12:16:25	86371	2.146	94.989
SUME27	207	12:19:25	87000	2.145	94.985	207	17:12:05	87878	2.449	95.138
SUME28	207	17:13:25	88000	2.451	95.139	207	17:46:45	88100	2.490	95.120
SUME29	207	17:48:25	89000	2.491	95.118	207	22:37:25	89867	2.184	94.914
SUME30	207	22:39:25	90000	2.182	94.912	207	23:52:25	90219	2.218	94.828
SUME31	207	23:53:45	91000	2.220	94.827	208	03:45:25	91695	2.508	94.999
SUME32	208	03:46:45	92000	2.509	95.000	208	04:30:45	92132	2.557	94.971
SUME33	208	04:32:45	93000	2.559	94.969	208	12:00:44	94344	2.075	94.628
SUME34	208	12:03:04	95000	2.073	94.626	208	13:00:05	95171	2.108	94.567
SUME35	208	13:03:05	96000	2.111	94.565	208	19:23:25	97141	2.559	94.857

Figure 140: Start and end times, FFID numbers and locations for multichannel seismic (MCS) lines SUME21-SUME35, SUMD30 and SUMD31, excluding turns. Times are extracted from the SEG-D headers and represent the system time on the Sercel, not UTC, although the clock was synchronised to UTC at the start of the experiment and is therefore correct to seconds.

Start		End		Depth	Comments
Julian Day	UTC Time	Julian Day	UTC Time		
206	16:57	207	01:40	12	All guns operational; Bird 1 consistently 6-9 m
207	01:40	207	03:20	12	Bird 1 consistently 7-8 m
207	03:20	207	06:09	12	
207	06:09	207	07:04	12	Streamer not fully settled
207	07:04	207	10:10	12	Bird 1 consistently 4.5-7 m
207	10:10	207	12:00	10?	Poorly recorded, possible misprint
207	12:00	207	15:00	12	Guns tested at beginning of line, finished by 207/12:44; Bird 1 consistently 14-17 m
207	15:00	207	17:12	12	
207	17:12	207	17:47	12	Streamer not fully settled (noisy)
207	17:47	207	22:37	12	Bird 1 consistently 4.5-6.5 m
207	22:37	207	23:52	12	Bird 1 consistently 7.5-8.5 m
207	23:52	208	03:45	12	
208	03:45	208	04:31	12	Short line, bird 1 8-10 m
208	04:31	208	09:40	12	Bird 1 rising from ~6 m to ~9.5 m during period
208	09:40	208	12:01	12	
208	12:01	208	13:00	12	Bird 1 8-9 m
208	13:00	208	19:23	12	Bird 1 8-10 m
209	13:40	210	11:06	12	Gun 4 not working at start, repaired at 109/15:51
210	11:06	210	13:00	12	Bird 1 consistently around 7 m

Table 28: Log of the streamer depth, set by command to the depth control birds, during the acquisition of MCS (MCS) lines SUME21-SUME35, SUMD30 and SUMD31.

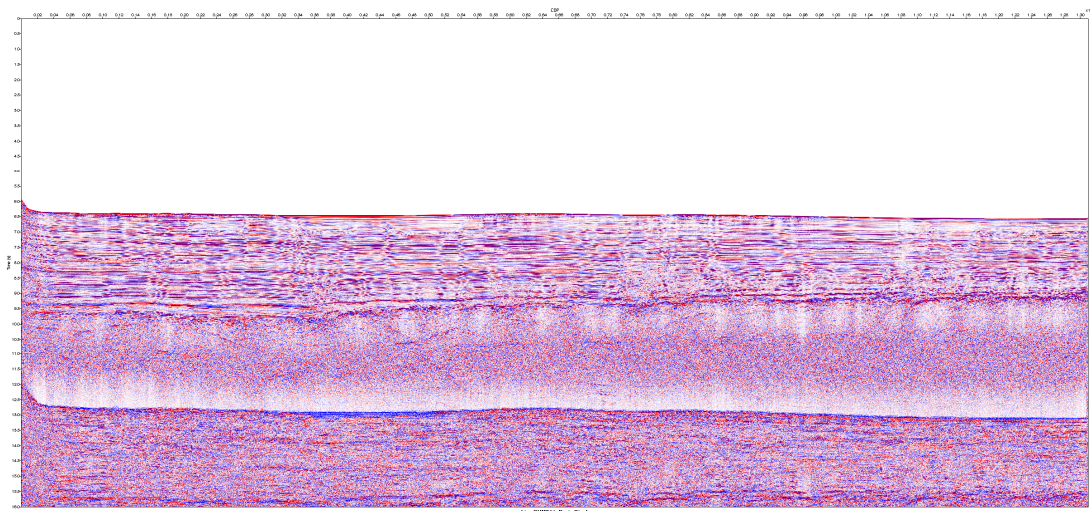

Figure 141: Stacked multichannel seismic section for profile SUME21.

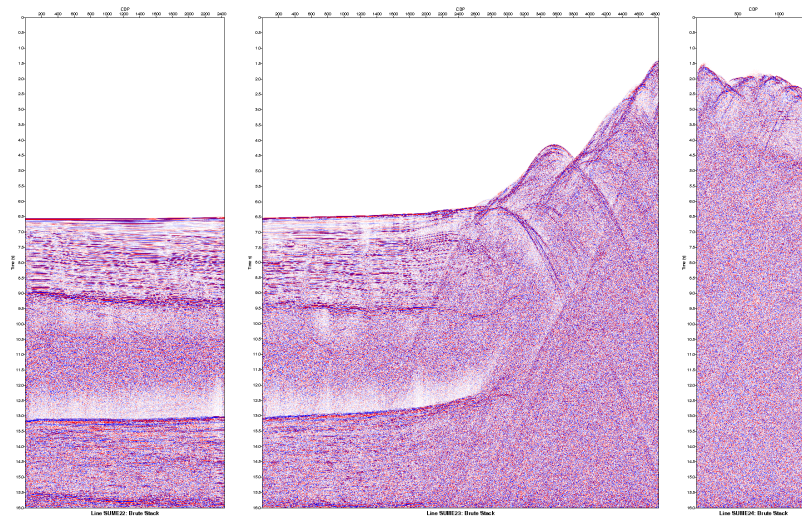

Figure 142: Stacked multichannel seismic sections for profile SUME22 (left), SUME23 (centre) and SUME24 (right).

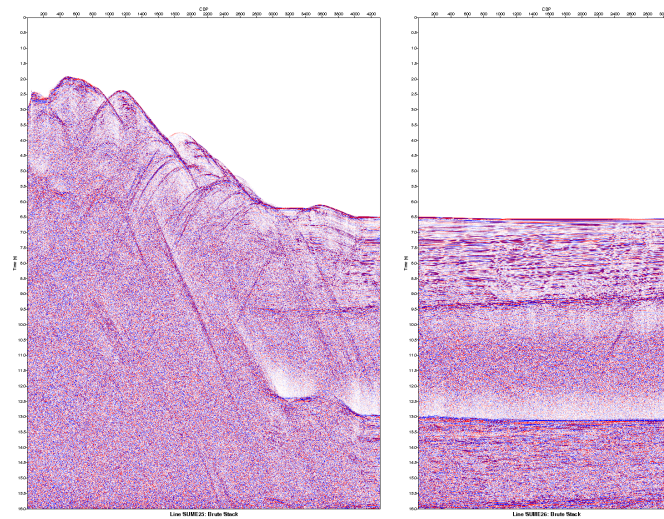

Figure 143: Stacked multichannel seismic sections for profile SUME25 (left) and SUME26 (right).

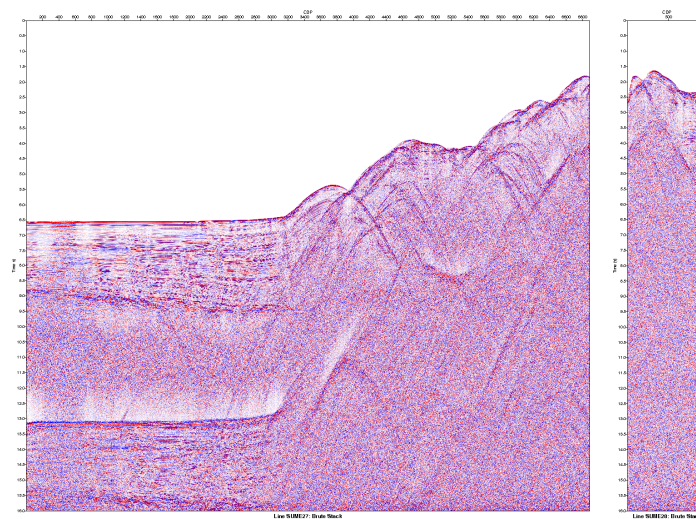

Figure 144: Stacked multichannel seismic sections for profile SUME27 (left) and SUME28 (right).

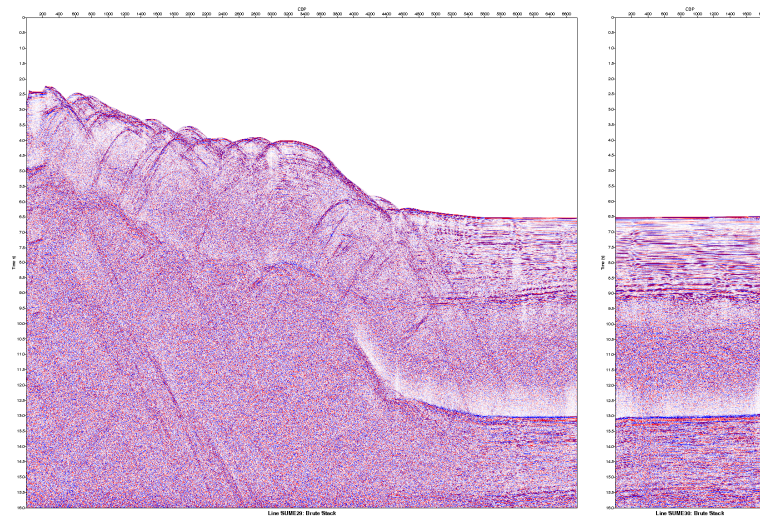

Figure 145: Stacked multichannel seismic sections for profile SUME29 (left) and SUME30 (right).

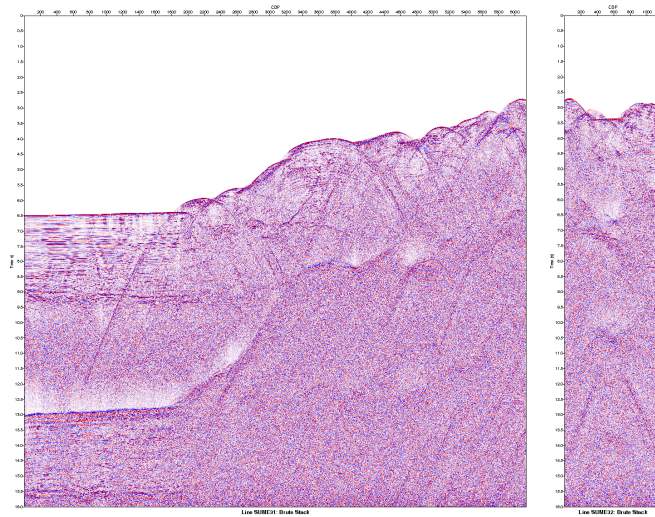

Figure 146: Stacked multichannel seismic sections for profile SUME31 (left) and SUME32 (right).

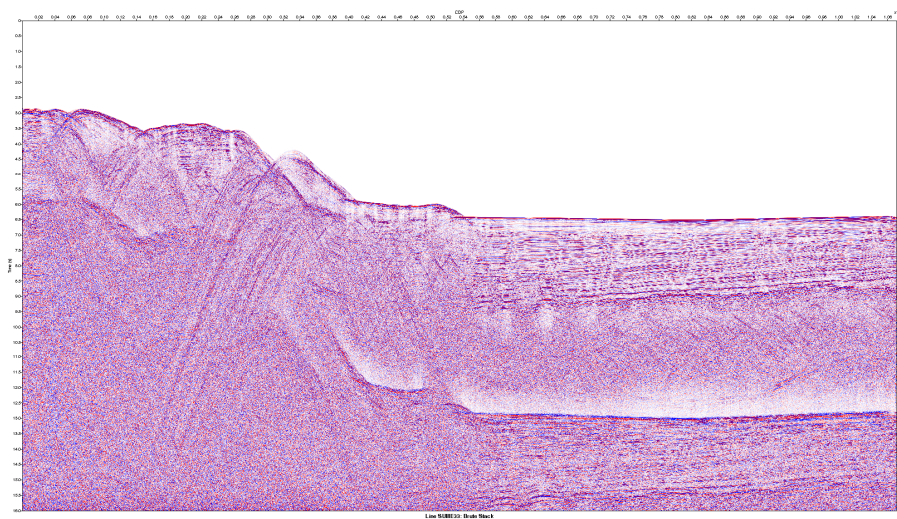

Figure 147: Stacked multichannel seismic section for profile SUME33.

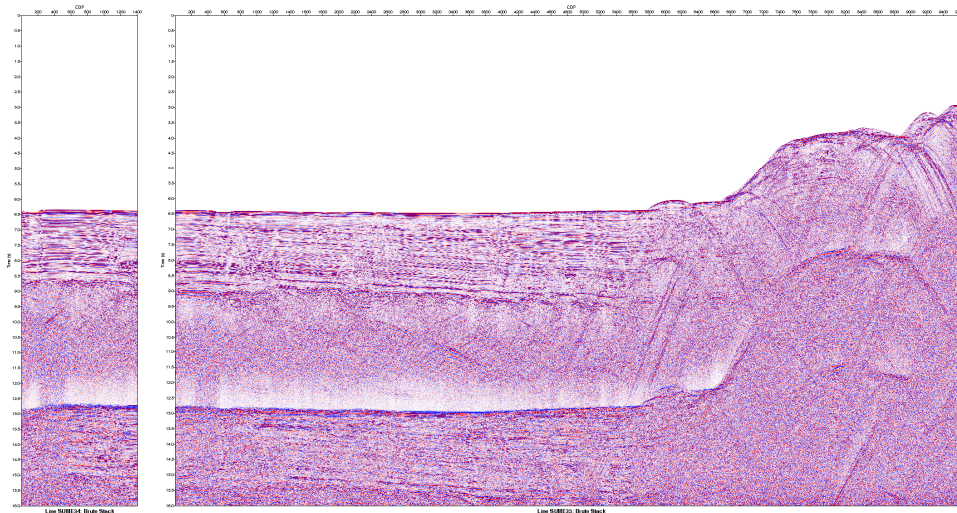

Figure 148: Stacked multichannel seismic sections for profile SUME34 (left) and SUME35 (right).

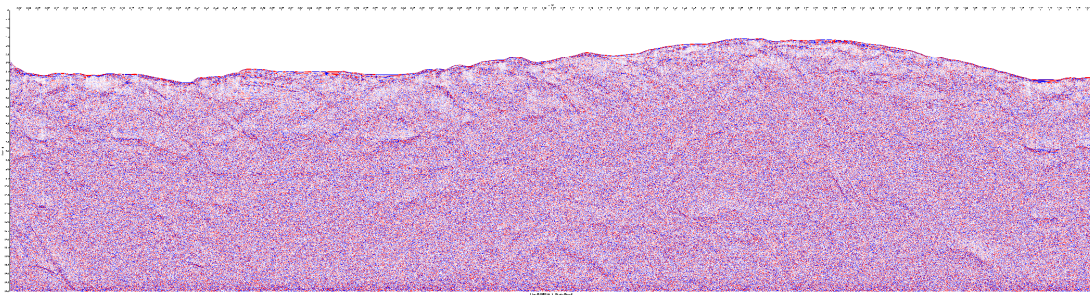

Figure 149: Stacked multichannel seismic section for the northern part of profile SUND30.

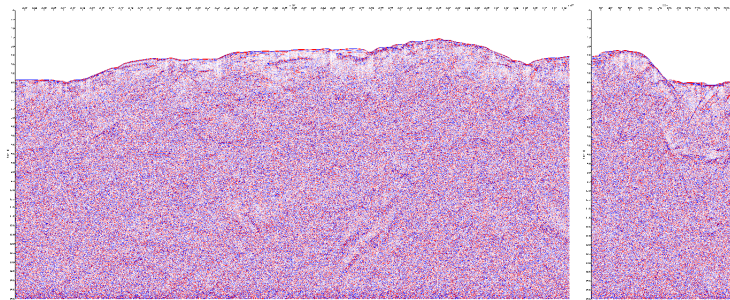

Figure 150: Stacked multichannel seismic sections for the southern part of profile SUND30 (left) and SUND31 (right).

Expendable bathythermograph data

A total of 6 XBT probes were deployed during the high-resolution and strike line MCS operations, before the airguns were deployed, during transit, and after they were recovered (Table 29 and Figure 151), when the airguns were onboard the ship.

Sequence (deployment) number	Probe type	Latitude	Longitude	Approximate water depth (m)
116	T5	2.51059	94.94194	
117	T5	1.88617	95.66865	
118	T5	0.65464	97.10412	
119	T5	-1.29492	97.94316	
120	T5	-1.30166	97.94546	
121		Not deployed		
122	T7	-2.51027	99.13853	

Table 29: Launch details for XBTs deployed during the high-resolution and strike line survey.

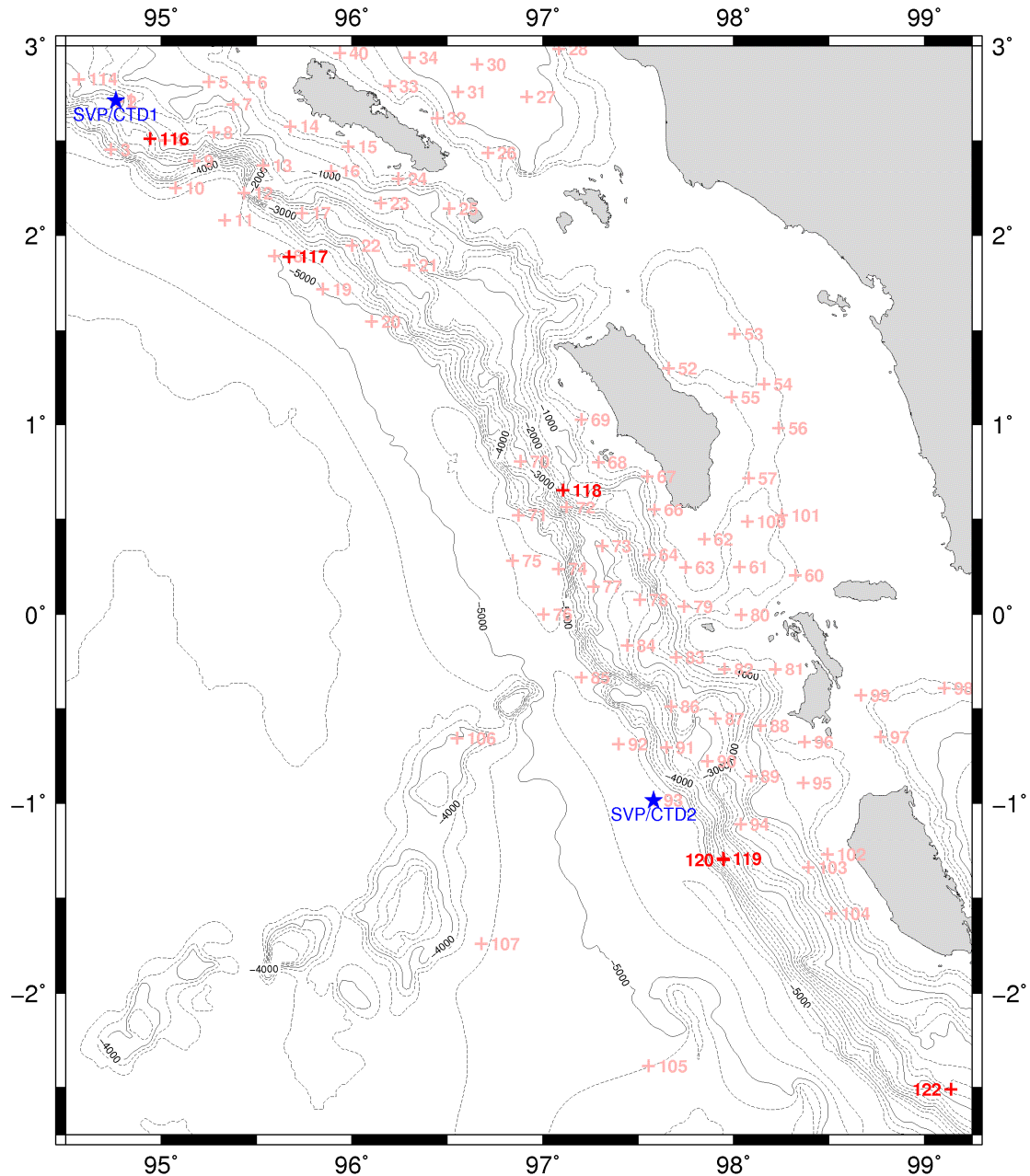

Figure 151: Location of the XBTs deployed during the high-resolution and strike line survey (red crosses) and their Sequence number; faint red crosses identify XBTs deployed earlier in SO198-2 and during SO198-1. The blue stars show the location of the SVP/CTD deployments acquired during SO198-1.

Summary of results for SO198

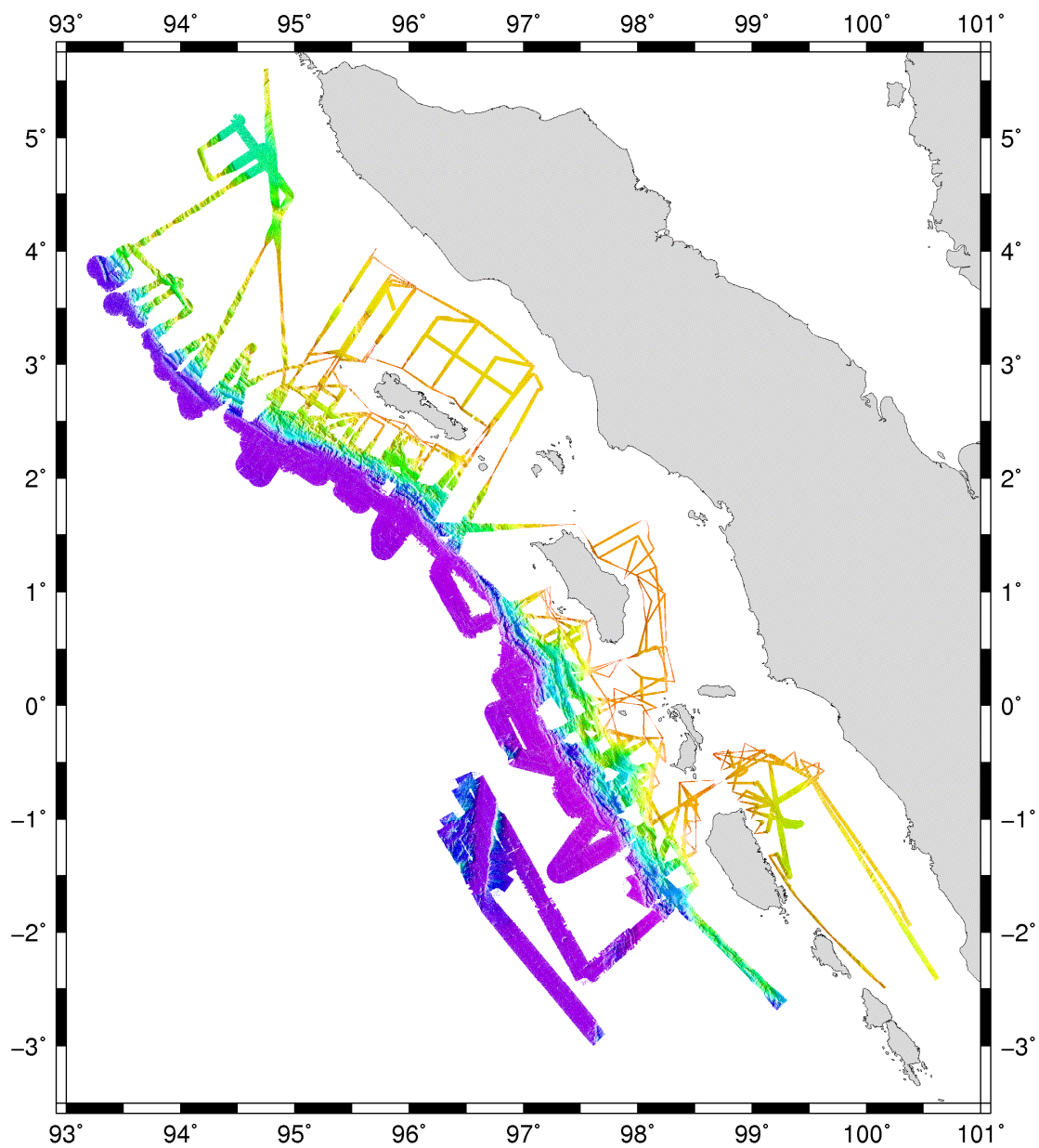

Figure 152: Swath bathymetry acquired during SO198.

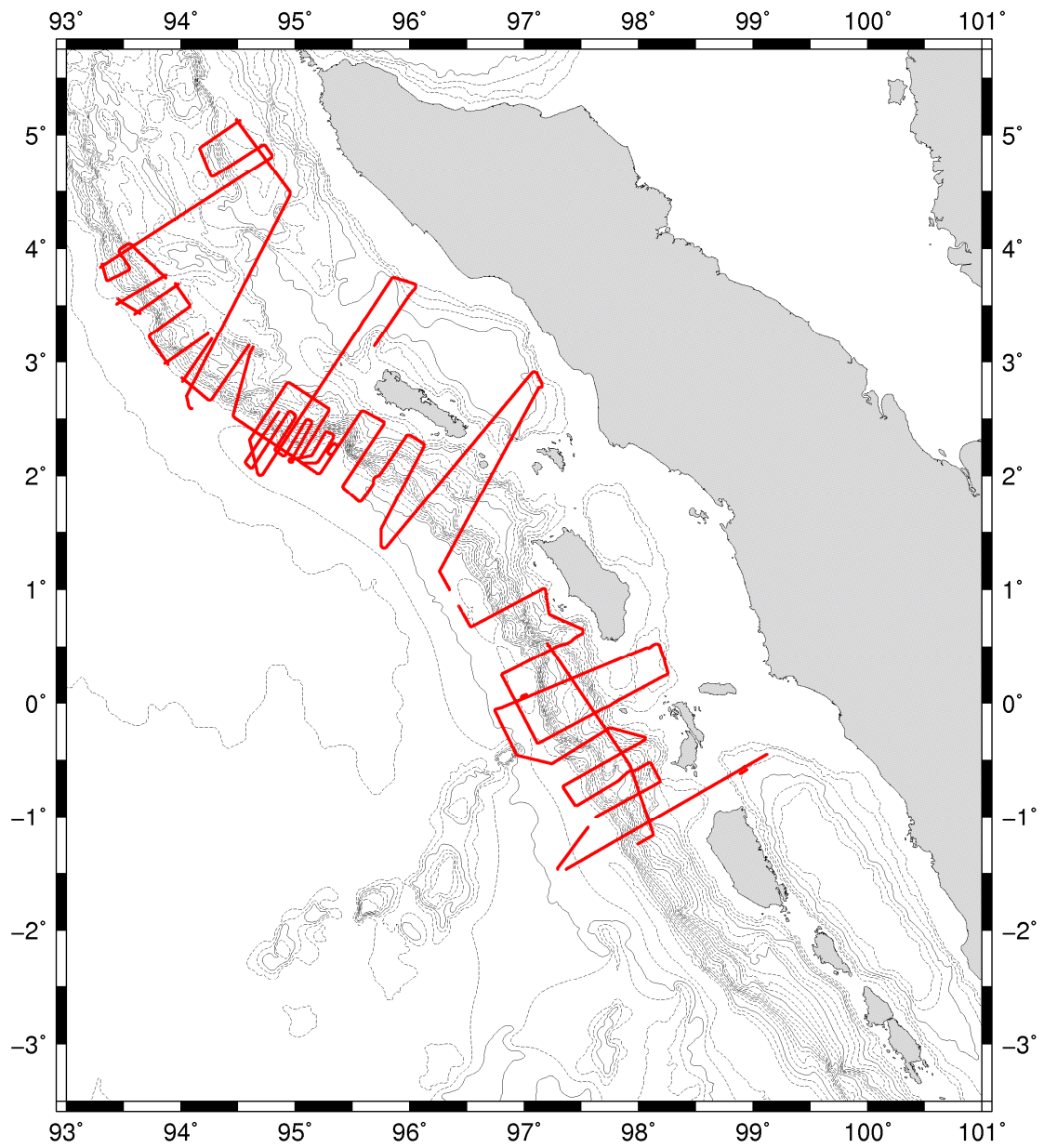

Figure 153: The location of multichannel seismic (MCS) data acquired during SO198.

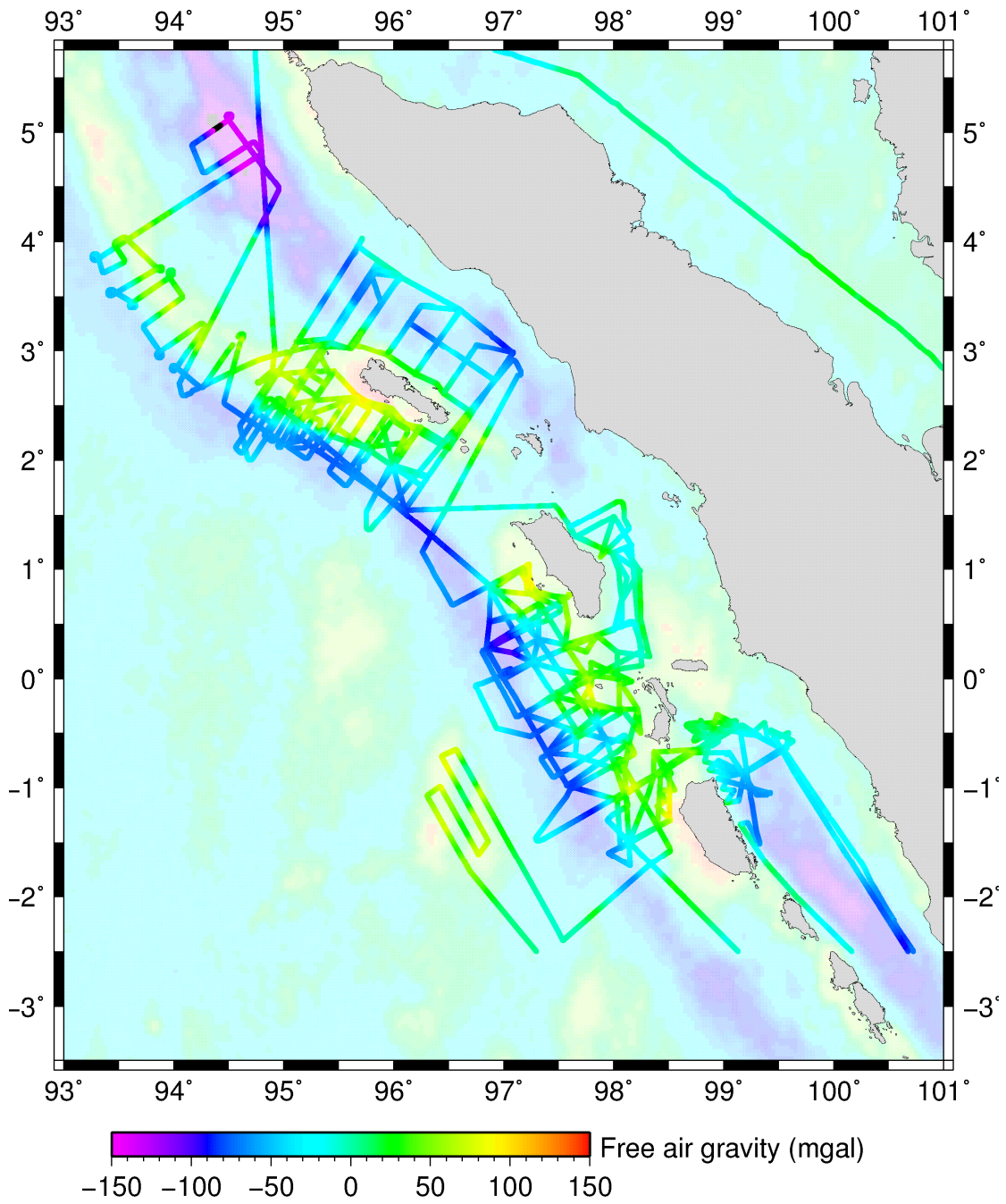

Figure 154: Gravity data acquired during SO198. The background grid is from Sandwell and Smith (1997).

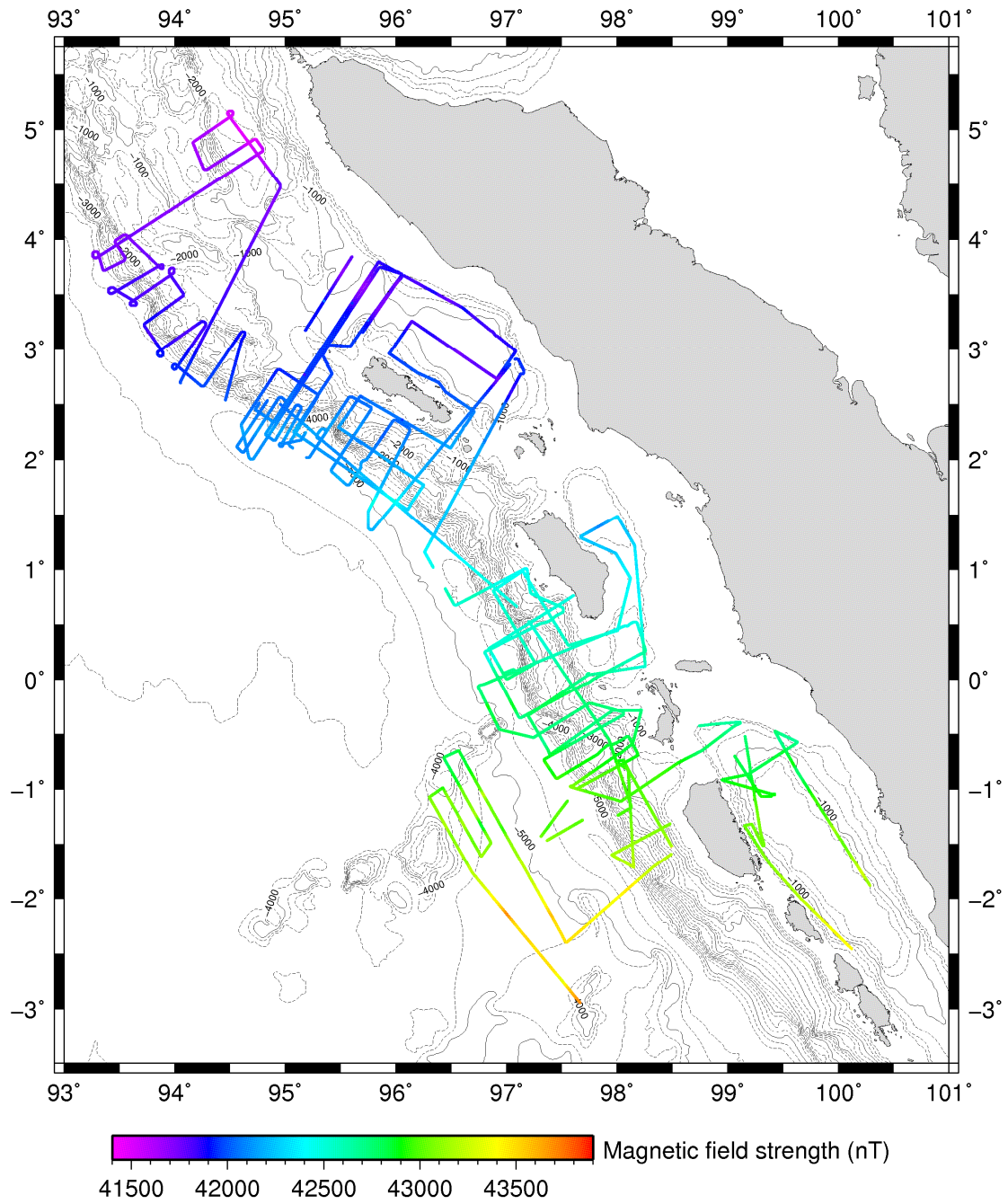

Figure 155: Magnetic data acquired during SO198.

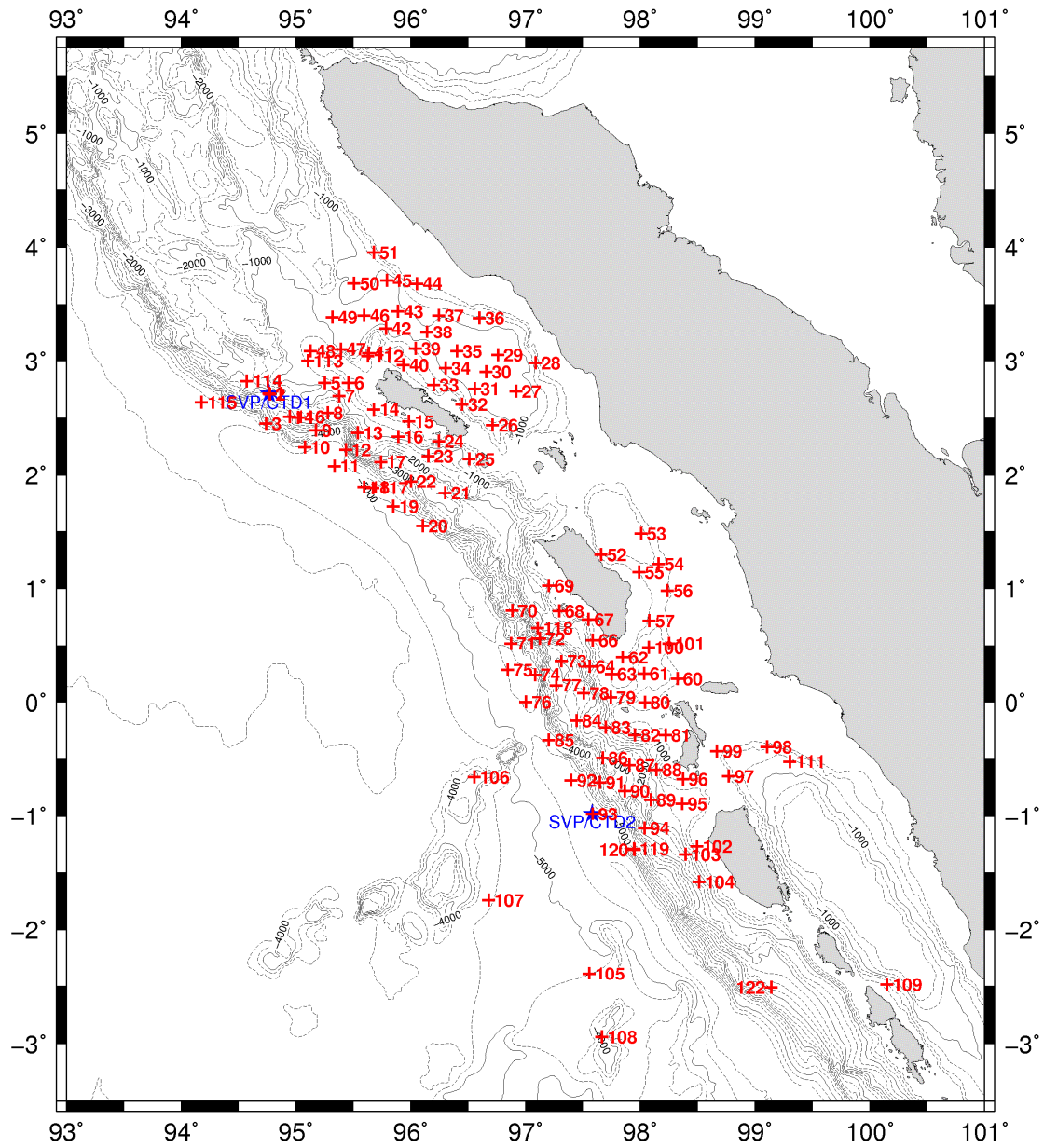

Figure 156: Location of XBTs (red crosses) and SVP/CTDs (blue stars) deployed during SO198.

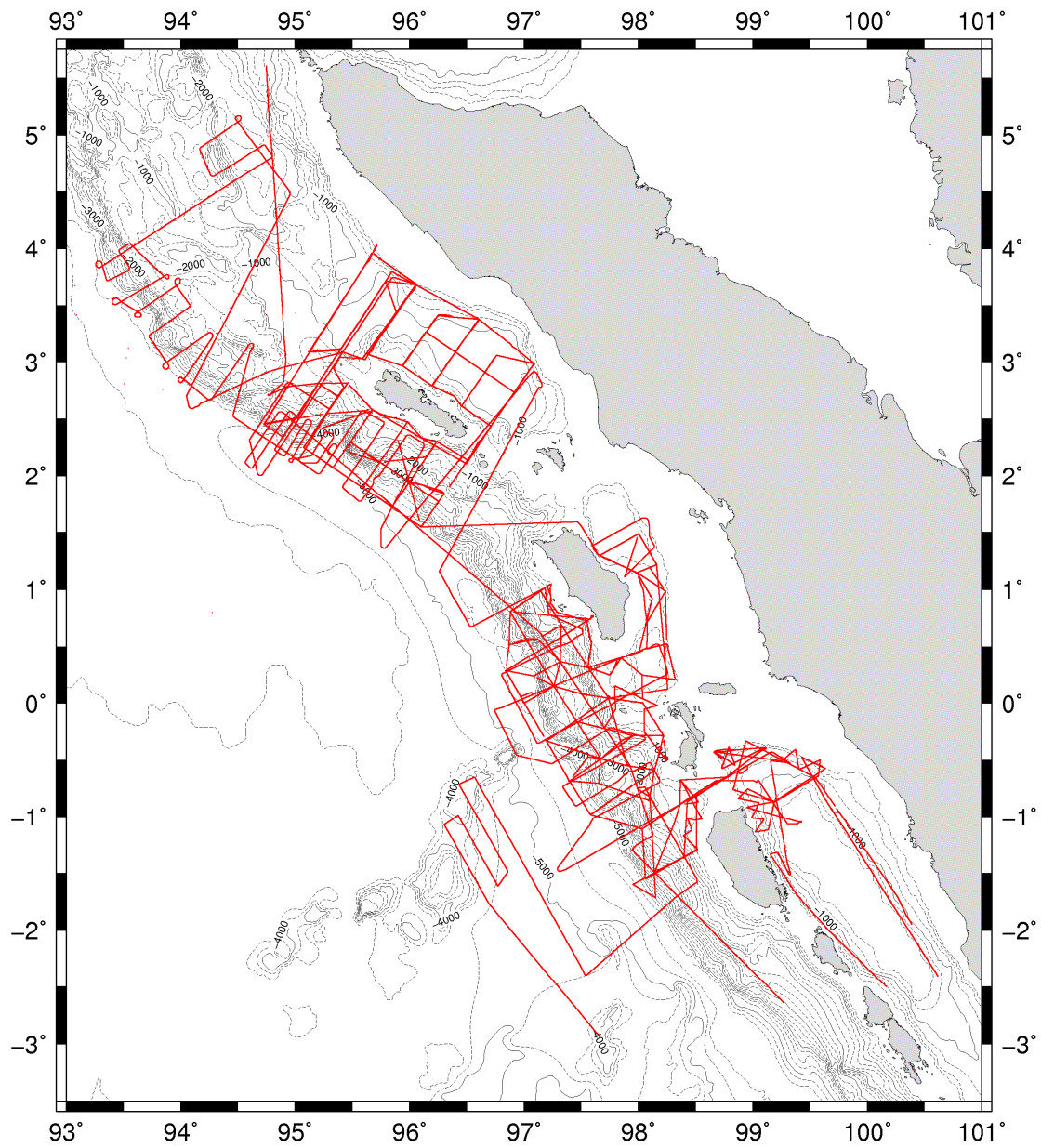

Figure 157: The location of *Parosound* sub-bottom profiler data acquired during SO198.

References

Atlas Elektronik GmbH, The ParaDigMA System (4.01) Digital Acquisition of Parasound Seismograms: User and Reference manual, GeoB, Department of Geoscience, University of Bremen, Bremen, 24th June 1994.

British Oceanographic Data Centre, GEBCO Digital Atlas compiled by R. L. Fisher, 197.

Chen, C.-T. and F. J. Millero, Speed of sound in seawater at high pressures, *J. Acoust. Soc. Am.*, 62, 1129-1135, 1977.

Fofonoff, N. P., and R. C. Millard Jr., Algorithms for computation of fundamental properties of water, *UNESCO Technical Papers in Marine Science*, 44, UNESCO Division of Marine Science (Paris), 53pp, 1983.

Marine Magnetics Corporation, SeaSPY Operation Manual Revision 4.7, Markham, Canada, 2008.

Sandwell, D. T., and W. H. F. Smith, Marine gravity anomaly from Geosat and ERS-1 satellite altimetry, *J. Geophys. Res.*, 102, 803-827, 1997.

Taner, M. T., F. Koehler and R. E. Sheriff, Complex seismic trace analysis, *Geophysics*, 44, 1041-1063, 1979.

Zyfer Inc., GPStarplus Model 565 User's Manual, Document 565-8006 Revision C, Anaheim, 8th November 2001.

Appendix A: Cruise data

./SO198-2-RawMCS	Multichannel seismic data <ul style="list-style-type: none"> - SEG-D format by line (SUMD/E)
./SO198-2-MCS-BruteStack	Shipboard stacks of the MCS in SEG-Y format
./SO198-2-Gun_logger	Airgun trigger pulse record <ul style="list-style-type: none"> - OBS instrument (see SO198-1) - 4x4 format data
./SO198-2-EM120-RAW	Swath Bathymetry <ul style="list-style-type: none"> - EM120 manual - EM120 configuration file - Caris vessel file - Caris project (on UTIG disk) - Raw data (by day)
./SO198-2-Paradigma	Parasound Sub-bottom Profiler <ul style="list-style-type: none"> - Raw data (by day)
./SO198-2-LongShot	LongShot Gun Controller Log <ul style="list-style-type: none"> - Text format
./SO198-2-Documents	Cruise Documents (scans) <ul style="list-style-type: none"> - Geophysical log books 1-3 - XBT log book - Gravity meter log book - Longshot log books 1-2 - Streamer log books 1-2 - EEL streamer logs - Bridge log
./SO198-2-Gravity	Gravity <ul style="list-style-type: none"> - /logged by laptop (1-minute data) ASCII format - /RAW meter data
./SO198-2-Magnetics	Magnetics <ul style="list-style-type: none"> - .mag Raw data - .XYZ ASCII data
./SO198-2-XBT	Expendable Bathythermographs <ul style="list-style-type: none"> - /T5 Raw T5 probe data - /T7 Raw T7 probe data
./SO198-2-Database-Export	Vessel Logs <ul style="list-style-type: none"> - /NAV ASCII format navigation etc. - /MRU ASCII format relative motion unit (heave/pitch/roll) - /AirWater ASCII format air/water environment

Appendix B: Julian Day Calendar

June	Julian Day	July	Julian Day
1	153	1	183
2	154	2	184
3	155	3	185
4	156	4	186
5	157	5	187
6	158	6	188
7	159	7	189
8	160	8	190
9	161	9	191
10	162	10	192
11	163	11	193
12	164	12	194
13	165	13	195
14	166	14	196
15	167	15	197
16	168	16	198
17	169	17	199
18	170	18	200
19	171	19	201
20	172	20	202
21	173	21	203
22	174	22	204
23	175	23	205
24	176	24	206
25	177	25	207
26	178	26	208
27	179	27	209
28	180	28	210
29	181	29	211
30	182	30	212
		31	213

Table 30: Julian Day dates for the months of June and July 2008.

Appendix C: RV Sonne

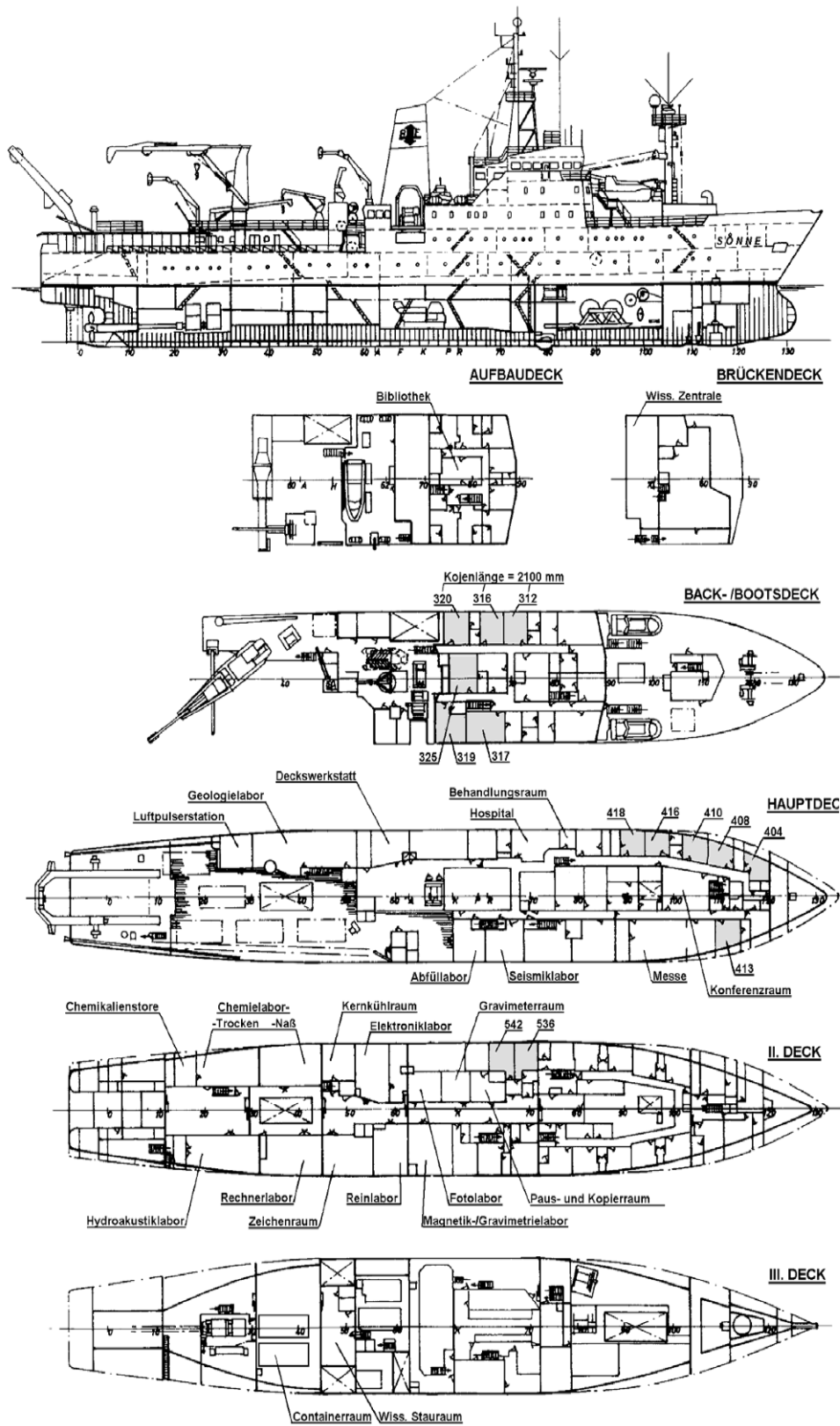

Figure 158: General deck plan for the RV Sonne.