

On the Biology of Krill Euphausia superba

**Proceedings of the Seminar
and Report of the Krill Ecology Group**

Bremerhaven, 12.–16. May 1983

Edited by S. B. Schnack

Berichte zur Polarforschung, Sonderheft 4, Dezember 1983

Hinweis

Die Berichte zur Polarforschung werden vom Alfred-Wegener-Institut für Polarforschung in Bremerhaven* in unregelmäßiger Abfolge herausgegeben.

Die Beiträge geben nicht notwendigerweise die Auffassung des Instituts wieder.

Die von den Verfassern eingereichten Manuskripte sind nicht redigiert.

Notice

The Reports on Polar Research are issued by the Alfred-Wegener-Institute for Polar Research, in Bremerhaven*, Federal Republic of Germany. They appear in non-regular intervals.

The papers contained in the Reports do not necessarily reflect the opinion of the institute.

Manuscripts have been printed without reviewing scientific content.

* Anschrift

Alfred-Wegener-Institut
für Polarforschung
Columbus-Center
D-2850 Bremerhaven
Telefon (04 71) 4 90 06/7
Telex 02 38 695 polar d
Telegramm: Polar Bremerhaven

* Address

Alfred-Wegener-Institute
for Polar Research
Columbus-Center
D-2850 Bremerhaven
Federal Republic of Germany
Phone (04 71) 4 90 06/7
Telex 02 38 695 polar d
Telegram: Polar Bremerhaven

FOREWORD

The Seminar under the auspices of the SCAR Group of Specialists on the Southern Ocean Ecosystem and their Living Resources reviewed the present state of knowledge on the biology of Euphausia superba Dana in order to indicate the major gaps in knowledge and to suggest steps to fill them within the framework of BIOMASS.

Participants had been invited on the basis of their particular knowledge and experience in the various krill research fields. The seminar was not meant as a formal symposium. However, some papers were required to set the stage for the discussions in small groups.

In an introductory talk, summarizing the 'First International Antarctic Krill Biology Symposium' in Wilmington, October 1982, Professor R.Y. George provided the participants of the Bremerhaven meeting with a review of the latest krill research projects.

Following this, the seminar consisted of six formal review talks on key problems in krill ecology and biology given by invited speakers:

- Dr. I. Everson: Estimations of krill abundance,
- Dr. T. Nemoto: Aspects of krill distribution assessed by the feeding analysis of larger predators,
- Dr. J. Beddington: Problems of modelling population dynamics of krill,
- Dr. C.M. MacDonald: Krill stock separation by electrophoretic analysis,
- Dr. U. Kils: Energetics and mechanics of swimming and feeding,
- Dr. F. Buchholz: Moulting and moult physiology in krill.

The seminar was split along three major topics:

1. Early life history,
2. Physiology and biochemistry including moulting, growth, longevity, krill growth model, feeding, energy budget, and vision,
3. Distribution and stock identity including also swimming, swarming, migration, in situ observations, field sampling and models of population dynamics.

Status reports on these topics by the participants were presented in plenary sessions followed by discussions in small sub-groups to define the gaps and directions. Towards the end of the seminar the current krill research programme as well as that planned for the future were discussed in the view of the forthcoming SIBEX-programme.

This proceedings volume consists of papers presented at the seminar. Some krill experts who were unable to attend personally had contributed manuscripts: G. Ettershank, R.R. Makarov, D.G.M. Miller, K. Nasu. S. Schnack compiled the papers and edited them for formal uniformity, but no effort was made to review the scientific content.

I express my thanks to the chairmen (I. Everson, R.Y. George, S. Rakusa-Suszczewski) and to the rapporteurs (A. Clarke, C.M. MacDonald, D. Morris, J.-O. Strömberg) of the sub-groups. G.S. Dieckmann, I. Everson and W. Hagen helped to bring some of the papers into more idiomatic English, and S. Marschall did the final typing. I wish to thank them for their help. My thanks are also due to S. Schnack for the preparation of the seminar. Under her guidance C. Dieckmann, S. Marschall, E. Mizdalski and D. Carsten of the local staff assisted the seminar in a very efficient and charming manner.

Gotthilf Hempel

CONTENTS

	Page
R.Y. GEORGE. Krill swarms and life cycle in relation to physical and biological oceanographic parameters in the Southern Ocean.....	9
 Early life history	
A. MUJICA and V. ASECIO. Distribution and abundance of krill larvae (<u>Euphausia superba</u> Dana).....	21
I. HEMPEL. Studies in eggs and larvae of <u>Euphausia superba</u> and <u>Euphausia crystallorophias</u> in the Atlantic sector of the Southern Ocean.....	30
R.R. MAKAROV. Geographical aspects in the investigation of the life history of <u>Euphausia superba</u> Dana.....	47
R.R. MAKAROV. Some problems in the investigation of larval euphausiids in the Antarctic.....	58
H.-P. MARSCHALL. Sinking speed of krill eggs and timing of early life history stages.....	70
R.Y. GEORGE and J.-O. STRÖMBERG. Development of eggs of Antarctic krill <u>Euphausia superba</u> in relation to pressure.....	74
Summary.....	75
 Physiology and biochemistry	
F. BUCHHOLZ. Moulting and moult physiology in krill..	81
T. IKEDA, P. DIXON and J. KIRKWOOD. Laboratory observations of moulting, growth and maturation of the Antarctic krill (<u>Euphausia superba</u> Dana).	89
H. ASTHEIMER, H. KRAUSE and S. RAKUSA-SUSZCZEWSKI. A simple krill growth model.....	91
P. MAYZAUD. Potential relationships between particulate matter and nutritional processes of <u>Euphausia superba</u> . A review of the results obtained during the MD25/FIBEX cruise.....	92
A. CLARKE and D. MORRIS. Development of an energy budget for <u>Euphausia superba</u>	102

D. MORRIS. Experimental investigations of the ecological physiology of <u>Euphausia superba</u>	111
A. CLARKE. Biochemistry of <u>Euphausia superba</u>	121
Summary.....	125
 Distribution, stock identity and population models	
U. KILS. Swimming and feeding of Antarctic krill, <u>Euphausia superba</u> - some outstanding energetics and dynamics, some unique morphological details.	130
I. EVERSON. Estimation of krill abundance.....	156
O. GUZMAN. Distribution and abundance of Antarctic krill (<u>Euphausia superba</u>) in the Bransfield Strait.....	169
A.P. TOMO. Study on the diurnal migration of <u>Euphausia superba</u> and the formation of shoals.....	191
A.P. TOMO. Observations on krill shoals luminescence at surface level and the accompanying fauna.....	196
T. ANTEZANA and K. RAY. Aggregation of <u>Euphausia superba</u> as an adaptive group strategy to the Antarctic ecosystem.....	199
K. NASU. On the geographic boundary of Antarctic krill distribution.....	216
T. NEMOTO. Some aspects of distribution of krill assessed by larger predators.....	223
M. STEIN and S. RAKUSA-SUSZCZEWSKI. Micro-scale structure of water masses and bottom topography as the basis for krill distribution in the SE Bransfield Strait February-March 1981.....	225
G. ETTERS HANK. The age structure of a population of the Antarctic krill <u>Euphausia superba</u> Dana.....	226
V. SIEGEL. Population structure of <u>Euphausia superba</u> in the eastern part of the Bransfield Strait....	227
R. SCHNEPPENHEIM and C.M. MACDONALD. Population genetics of krill (<u>Euphausia superba</u>).....	239
C.M. MACDONALD and R. SCHNEPPENHEIM. Breeding structure and stock identity in the Antarctic krill <u>Euphausia superba</u> Dana.....	240
W.S. GRANT. Population genetics of krill and comparison with other marine organisms.....	246

T. POMMERANZ. Analytical evaluation of technical RMT1+8 tow data.....	267
J.R. BEDDINGTON. Some problems in modelling the dynamics of krill.....	268
Summary.....	269
Summary of the discussions on plans for SIBEX in the south-west Atlantic sector and of the discussions of the various sub-groups.....	280
D.G.M. MILLER. Krill biology and FIBEX: Some problems of co-operative data analysis relevant to the planning of SIBEX.....	285
Working Party on Krill Ecology. Report of the First Meeting, 20 May 1983.....	297
List of participants.....	301

KRILL SWARMS AND LIFE CYCLE IN RELATION TO PHYSICAL
AND BIOLOGICAL OCEANOGRAPHIC PARAMETERS IN THE SOUTHERN OCEAN

by

Robert Y. George

Introduction

As outlined in the program, my task is to provide a synthesis of the Wilmington 1982 Krill Symposium on "Krill Swarms and Its Life Cycle."

During the Discovery Expeditions (Marr 1962), we learned a great deal about the Antarctic krill Euphausia superba which is extremely important because of its great commercial significance and scope for potential harvest for human and animal consumption. This cold-adapted crustacean is also important from a scientific point of view because of its unique life cycle, behavioral repertoire, and special physiological and biochemical adaptations. It is to the second aspect that the Krill Symposium in Wilmington focused upon.

In the past 4 or 5 years, there has been an outburst of studies on krill by various investigators from different institutions representing primarily the Antarctic Treaty countries. As a result, we have, in the literature, a potpourri of hypotheses concerning the biology of krill. Some of these recent findings are sound facts. Some are highly speculative ideas whereas a few are conflicting opinions. The 1982 Symposium, in essence, brought together a number of active krill researchers to address the biology of krill on the basis of the state of our knowledge today. Two major themes were emphasized, one revolving around the krill swarm in relation to biological and physical environment and a second theme dealing with the life cycle and physiology of krill. A total of 22 scientific papers were presented and a workshop following the Symposium addressed krill biology in

relation to water masses, and this workshop involved participation by three key physical oceanographers including Sir George Deacon, one of the Discovery investigators.

If we look at the water mass structure around the Antarctic continent, the mesoscale pattern is reasonably defined although there exists a confusing nomenclature about the terms used to delineate the major boundaries such as Antarctic Convergence or Divergence. It is still not clear what role water mass movements play in relation to the horizontal and vertical movements of krill. When it comes to regional currents, our knowledge is meager. Presumably, biological boundaries are not necessarily coinciding with physical boundaries because of meanders and eddy effect.

Krill swarms

Krill swarms tend to be more pronounced in certain regions of the Southern Ocean particularly in the Scotia Sea - Weddell Sea region. The size of these swarms and the pattern of their distribution, horizontal and vertical, has been the subject of study by several investigators in recent years. Recently Macaulay of U.S. National Oceanic and Atmospheric Administration presented a fairly comprehensive account on krill swarms (Macaulay et al. in press). Here are some of the profiles or echograms obtained in the Elephant Island - Bransfield Strait area in 1981 austral summer (Fig. 1-2). These echograms were obtained by towing 4' fin containing two down-looking transducers with 50 and 120 KHz frequency to document swarms in subsurface layers and a side-looking transducer of 105 KHz frequency to monitor the surface swarm down to 20 meters. With the use of appropriate equations derived in collaboration with mathematicians Macaulay et al. (in press) projected krill biomass figures on the basis of acoustic data. The estimate of peak biomass is as much as 2.1 million metric tons of krill occurring within a surface area of 450 km² in one of the super swarms observed north of Elephant Island during the Melville cruise in 1981. Moreover,

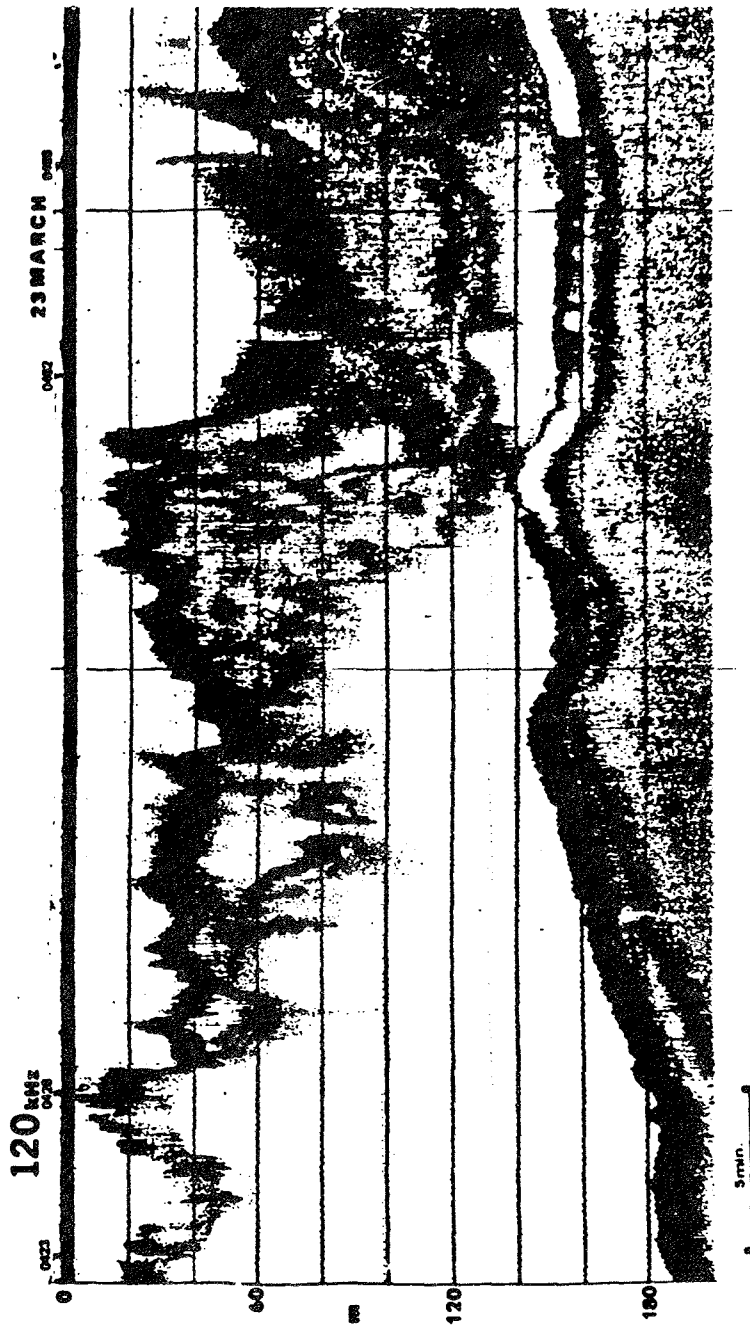

Fig. 1 Echogram of large krill swarm north of Elephant Island, March 23, 1981. (Courtesy of Dr. Macaulay). Note that the frequency scale is 120 KHz and maximum depth of swarm 140 meters.

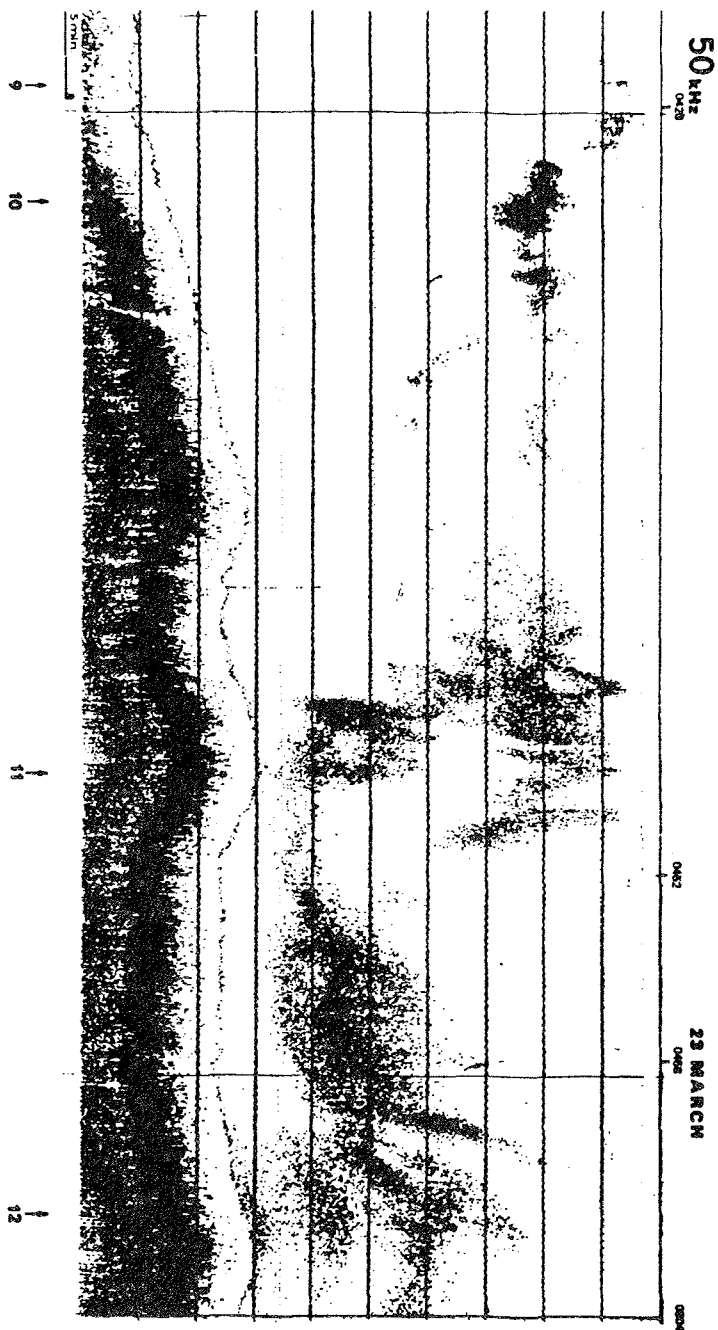

Fig. 2 Echogram of patchy krill swarm of Elephant Island, March 23, 1981. (Courtesy of Dr. Macaulay).

the average size of krill patch appears to be 100-500 meters in horizontal extent and 40-60 meters in bathymetric range. In a thick and dense swarm, the biomass reaches a value of 500 grams/m³. In patchy or diffused krill schools, the biomass is as low as 40-150 grams/m³. According to acoustic data, the number of individuals per m³ is 75-300 which seems to be an underestimate in orders of magnitude lower than net catch or in situ observations. It appears as though the swarms tend to occupy both shelf depths and oceanic regions with depth contours exceeding 1,000 meters. Most of the swarms of the Antarctic Peninsula area, primarily in the Bransfield Strait region, occur in depths lower than 150 meters and outside the Strait, occur over the shelf break. The impact of bottom topography on krill swarm has been earlier pointed out by Russian investigators (Makarov 1980, Voronina 1974, Ivanov 1970); however, spawning krill tend to school in open ocean conditions, and it is still not clear how the selection is made, and this may have a bearing upon the success of egg development.

There is also considerable new information on movement of krill school and behavioral responses in relation to predator impact. Hamner (in press) has provided new data on the basis of his diving within krill swarms in Bransfield Strait area. Accordingly, krill swarm should be looked upon as a "super organism" moving densely in one direction. The school exhibits infinite variety of shapes. It moves very seldom vertically but often obliquely or horizontally at an average speed of 20 cm/sec, nevertheless, during escape responses when attacked by whales, seals, or birds or disturbed by divers, krill is capable of moving in very high speeds as much as 100 cm/sec. This is in line with the data obtained earlier by Kils (1979). The krill swimming speed is analysed from its two modes of behavior with low speed while schooling and feeding and high speed while escaping. Diver estimations reveal krill density as much as 2,000-30,000 per m³. Apparently schooling krill is not image-oriented. They tend to move within a flat sheet or in long thin ribbons. I have often observed schools

of krill swimming in the surface always in one direction. The limitation of in situ diver observation is the limited depth of coverage because the swarm has been noted to occur to depths of 240 meters, far beyond the limits of diver's penetration into the sea.

The biomass of krill is still not clearly quantified. Net catches of krill do provide interesting data on krill biomass, but the information is conjectural since it can inject an artifact because of the net avoiding behavior of large krill. Shulenberger et al. (in press) using a "Mocness" net arrived at some preliminary generalizations on krill biomass and population structure in the Scotia Sea. The data suggest significant day-night variations and swarm compositions included non-euphausiid fractions such as copepods. Brinton and Antezana (in press) using "Bongo" nets in the Elephant Island and Bransfield Strait area, arrived at some conclusions in relation to krill population structure. They observed non-reproductive stages exceeding 35 mm size in the eastern Scotia Sea and reproductive stages in the western Scotia Sea in size class ranging from 35-55 mm. In the Bransfield Strait, they found a mixture of the age groups and off Elephant Island, they found two different schools of krill, one dominated by adult males 50-55 mm and another dominated by adult females 30-50 mm. Quetin and Ross (in press) have specifically focused upon krill population structure in different locations in the Bransfield Strait during the austral summer 1982 and encountered predominantly juveniles in the southern regions and reproducing females occurring in the vicinity of South Shetland Island. Fevolden and George (in press) reported a total lack of reproductive stages of krill even in the vicinity of South Shetland Island in the succeeding austral summer (1983) and pointed out the possible year-to-year variation of krill population structure. They proposed a hypothesis that the Bransfield Strait area is really not a breeding zone but a nursery ground with a recruitment of first and second year class immature male and female krill originating from different sites outside the

Strait due to the influx of water mass. Fevolden (in press) has also conducted electrophoretic analyses of different origins. He has pointed out genetic variation induced by environmental conditions such as temperature and trophic diversity.

Krill feeding and energy flow

There has been some new data presented by Antezana and Ray (in press) on the feeding activities of krill within a swarm. There is evidence to point out that feeding and swarming are indeed co-occurring events. Their conclusion is based on both stomach pigment analysis as a function of time up to days or even weeks and on the high egestion rate of krill in the absence of food. Presumably, in dense swarms, krill not only feed on phytoplankton but also exhibits cocophagy. From the point of view of energy acquisition, there is obviously adaptive advantage in the krill swarming behavior. There is also new data on the feeding behavior of krill in laboratory experiments by close-up photography. Boyd et al. (in press) documented the motion of thoracic legs during feeding activity. The frequent and rhythmic opening and closing of the feeding basket calls for 30% of the metabolic energy. Krill is also able to feed on particles of wide size range from nanophytoplankton to macrozooplankton. Krill of 120 mg dry weight propels as much as 450 ml of water per hour. By using radio labelled Pb^{210} , they demonstrated selective phytoplankton uptake by krill. In another laboratory-oriented investigation, Morris (in press) provided data on maximum filtration efficiency and maximum retention effect. All these informations on krill feeding suggest rather strongly the high level of filtration rate or consequently the elevated energy flow into the krill individually and energy flow into the swarm collectively.

The dynamics of energy flow into krill swarm was another sub-theme during the Wilmington Krill Symposium. Three different papers address this question. Holm-Hansen and

Huntley (in press) arrived at an energy budget model based on krill biomass and productivity data from the area north of Elephant Island. They estimated daily need of 0.1-0.2 mg of carbon/m³ for a krill biomass of 10.6 mg dry weight/m³. This situation holds good outside a giant swarm in small krill patches; however, in dense swarms krill biomass reaches as much as 270 mg dry weight/m³ and demands an inflow of 2.4-5.4 mg carbon per day/m³. Phytoplankton productivity data suggest that in this region the production value is about 4.8-5.2 mg carbon per day/m³. Based on these computations, they concluded that the available energy in the swarm region can only sustain maintenance metabolism and cannot support growth. They pointed out that in Prydz Bay region daily production is 61 mg carbon/m³ and this may be the reason why krill size is larger. This hypothesis again calls for further experimentation. Ikeda (in press) has also looked at krill energetics. Approaching the problem from a different angle, he has estimated the energetics of krill in terms of respiration and excretion. He has also computed food requirements of E. superba on the basis of two different schemes of krill growth and life span - one theme incorporating the negative growth and no feeding in the winter and another scheme incorporating feeding activity and moulting in the winter. In the growth strategy involving body shrinkage in winter, the food requirements for the entire life cycle is significantly low (1500-1700 calories as opposed to 2100-2800 calories in the other model). Rakusa-Suszczewski and Godlewska (in press) addressed the energy flow within a swarm taking into account productivity plus respiration, and arrived at daily assimilation rates in calories. Based on his equations, the krill life cycle is presumably much longer than 3 years as often estimated. Moreover, significant differences occur between larvae and adults in terms of energetics. Here again is an area that calls for substantial amount of new informations.

Krill life cycle

George (in press) focused upon the early life cycle of the Antarctic krill E. superba. He has pointed out that significant changes occur in metabolic scope and performance between the various ontogenetic stages of krill. This is reflected in metabolic rate and in the ammonia excretion. The embryology of krill was also examined, particularly in relation to the impact of temperature and pressure on egg development. His data suggested that early larval stages are readily acclimated to high pressure conditions up to 200 atm whereas adult krill including gravid females are sensitive to pressure and can only be acclimated to 20 atm. This implies that spawning cannot occur at depths greater than 200 meters. Krill egg development is also influenced by temperature and pressure.

Clarke (in press) has examined the lipid content and composition of krill. The data suggests significant increase in total lipid during the summer, particularly in the females as the ovary matures. He found that E. superba does not store lipid for winter use as Euphausia crystallorophias. Apparently the primary component of the stored lipid is triacylglyceron.

Krill growth pattern

Mauchline (in press) arrived at an empirical growth model indicating active summer growth with substantial differences between the year classes. Ettershank (in press) offered an innovative new approach to differentiate age classes of krill on the basis of an assay of lipofuscin - a fluorescent pigment associated in cells with aerobically respiring organisms as a function of physiological time. The traditional approach has been to look at size or length frequency. This method can be misleading. Ettershank's model illustrates two size classes of krill population from Prydz Bay on the basis of length frequency. The pigment analyses revealed three different age groups which were further augmented by morphometric changes in

the mature female populations analysed in this study. Evidently, this is a promising field with great scope for future growth or longevity studies.

Basic questions recommended for research

This, in essence, is the outcome of the 1982 Krill Symposium which was followed by a one day workshop that formulated and recommended the following key questions for further research:

1. How does the krill swarm vary as a function of environmental parameters such as (a) temperature, (b) currents, (c) dissolved oxygen, (d) sub-marine topography, (e) primary productivity, (f) ammonium concentration, etc.?
2. Is there a circumpolar spread of E. superba with recurrent breeding phenomena in one or more breeding sites? Can we distinguish E. superba populations as separate breeding stocks for Weddell-Scotia Seas, Bellingshausen Sea, and Ross Sea? What do we know about krill stocks in these seas? What will be the impact of large scale harvesting of krill?
3. How can one explain the presence of E. superba outside the Antarctic Convergence? What influences do eddies have on krill distribution? What is krill distribution along ice edge zones, boundary or frontal zones?
4. What is the status of the krill stocks in winter? When production ceases in late austral summer, is there a shift in krill feeding strategies and metabolism? Do the juvenile and post-spawned krill seek an alternate source of food in the winter? Do we have year-round data on krill distribution, e.g. Bransfield Strait; South Georgia; Elephant Island?
5. Do we have accurate information on life span, age structure, and rematuration phenomena in krill?
6. Is there any synchrony between krill egg development (while descending) and its position in the vertical column? What do we know about the impact of pressure on krill embryology?

7. What is the growth strategy of krill during the winter months?
8. Are there any unique biophysical or biochemical adaptations in krill for living in extremely low temperature conditions?
9. Can we arrive at a model (three dimensional) on krill distribution on the basis of our knowledge on vertical and horizontal water mass movements?

These questions call for detailed investigations during the SIBEX studies and in future investigations to uplift our knowledge on the biology of the Antarctic krill E. superba.

Acknowledgements

I wish to thank Professor G. Hempel for inviting me to present this talk and to participate in this International Krill Conference in West Germany. I am also grateful to the Division of Polar Programs, U.S. National Science Foundation for sponsoring my visit to Bremerhaven.

References

- Antezana TJ, Ray K (in press) Feeding of Euphausia superba in a swarm north of the Elephant Island. J Crust Biol
- Boyd CM, Heyraud M, Boyd CN (in press) Feeding behavior of krill Euphausia superba. J Crust Biol
- Brinton E, Antezana T (in press) Characterization of krill swarms in Bransfield Strait. J Crust Biol
- Clarke A (in press) Lipid content and composition of Antarctic krill E. superba Dana. J Crust Biol
- Ettershank G (in press) A new approach to the assessment of longevity in the Antarctic krill Euphausia superba. J Crust Biol
- Fevolden S (in press) Biotic and physical environmental impact on genetic variation of krill. J Crust Biol
- Fevolden S, George RY (in press) Size frequency patterns of Euphausia superba in the Antarctic Peninsula Waters in austral summer, 1983. J Crust Biol

- George RY (in press) Ontogenetic adaptations in growth and metabolism of Euphausia superba in relation to pressure and temperature. J Crust Biol
- Hamner W (in press) Aspects of schooling in Euphausia superba. J Crust Biol
- Holm-Hansen O, Huntley M (in press) Feeding requirements of krill in relation to food sources. J Crust Biol
- Ikeda T (in press) Sequences in metabolic rates and elemental composition (C,N,P) during the development of Euphausia superba and estimated food requirements during its life span. J Crust Biol
- Ivanov BG (1970) On the biology of the Antarctic krill Euphausia superba. Mar Biol 7:340-351
- Kils U (1979) Swimming speed and escape capacity of Antarctic krill Euphausia superba. Meeresforsch 27:264-266
- Macaulay MC, English TS, Mathisen DA (in press) Characteristics of Antarctic krill (Euphausia superba) swarms from the Elephant Island and Bransfield Strait. J Crust Biol
- Makarov RR (1980) Study of population composition in Euphausia superba Dana. (in Russ). In: Lubimova TG (ed) Biological Resources of the Antarctic Krill. pp 88-113
- Marr JWS (1962) The natural history and geography of the Antarctic krill Euphausia superba. Discovery Rep 32:33-464
- Mauchline J (in press) Growth rates of larvae and adults of Euphausia superba. J Crust Biol
- Morris D (in press) Filtration rates of Euphausia superba: Under or over estimates? J Crust Biol
- Quetin LB, Ross RM (in press) School composition of the Antarctic krill Euphausia superba in the waters west of the Antarctic Peninsula, austral summer, 1982. J Crust Biol
- Rakusa-Suszczewski S, Godlewska M (in press) Energy flow through krill aggregations in the Drake Passage and the Bransfield Strait. J Crust Biol
- Shulenberger E, Wormuth JH, Loeb V (in press) Super swarms of Euphausia: Overview of patch structure and composition. J Crust Biol
- Voronina NM (1974) An attempt at a function analysis of Euphausia superba. Mar Biol 24:347-352

DISTRIBUTION AND ABUNDANCE OF KRILL LARVAE
(EUPHAUSIA SUPERBA DANA)

by

Armando Mujica and Verónica Asencio

Summary

The present study is an analysis of Euphausia superba larvae sampled during the FIBEX project by the Chilean expedition in January/February 1981. Special reference has been made to the distribution and composition of the different developmental stages.

The results revealed the presence of intermediate developmental stages (metanauplius, calyptopis and first furciliias). The absence of the first phases may indicate their deeper distribution and the absence of the most advanced is possibly related to the reproductive period.

The highest concentration of the larvae with a maximum density of 190,650 larvae/1000 m³ was found at both ends of the Bransfield Strait and in the vicinity of the South Shetland Islands.

Introduction

The importance of krill (Euphausia superba) in the Antarctic ecosystem and as a possible exploitable natural resource makes the knowledge of the basic biological aspects of the species essential, so that decision making to establish a management of the resource becomes feasible. Numerous studies have been done independently by the consultative countries of the Antarctic Treaty, however, the FIBEX project is the first investigation which succeeded in uniting efforts by different countries, with the goal to study the abundance and ecology of this species.

During the Post-FIBEX Data Interpretation Workshop in Hamburg in 1981, it was proposed that a detailed analysis of the distribution and abundance of the developmental stages of the larvae of E. superba be initiated by the countries possessing the appropriate data. The Chilean Antarctic Institute, conscious of the importance of such an investigation, established an agreement with the Fisheries Development Institute to carry out this study, the results of which are included here.

Materials and methods

Zooplankton samples were collected in January/February 1981 during daylight hours, in the Bransfield Strait and the Drake Passage, in the vicinity of the South Shetland Islands and Elephant Island (Fig. 1). A standard CALCOFI * net (mesh size 335 μm) with a 0.79 m^2 mouth area and provided with flow-meter was used. The sampling was done obliquely from a maximum depth of 200 metres to the surface, according to the methodology recommended by FAO in ichthyoplankton's studies (Smith and Richardson 1979).

The euphausiid larvae were extracted from the total sample or from an aliquot obtained with a FOLSON sub-sampler, when the zooplankton biomass exceeded 20 cc/1000 m^3 (Mujica and Torres 1982).

Identification of the different developmental stages of the larvae of E. superba was based principally on papers of Fraser (1936), Makarov (1980) and Kirkwood (1982).

* California Cooperative Oceanic Fisheries Investigation

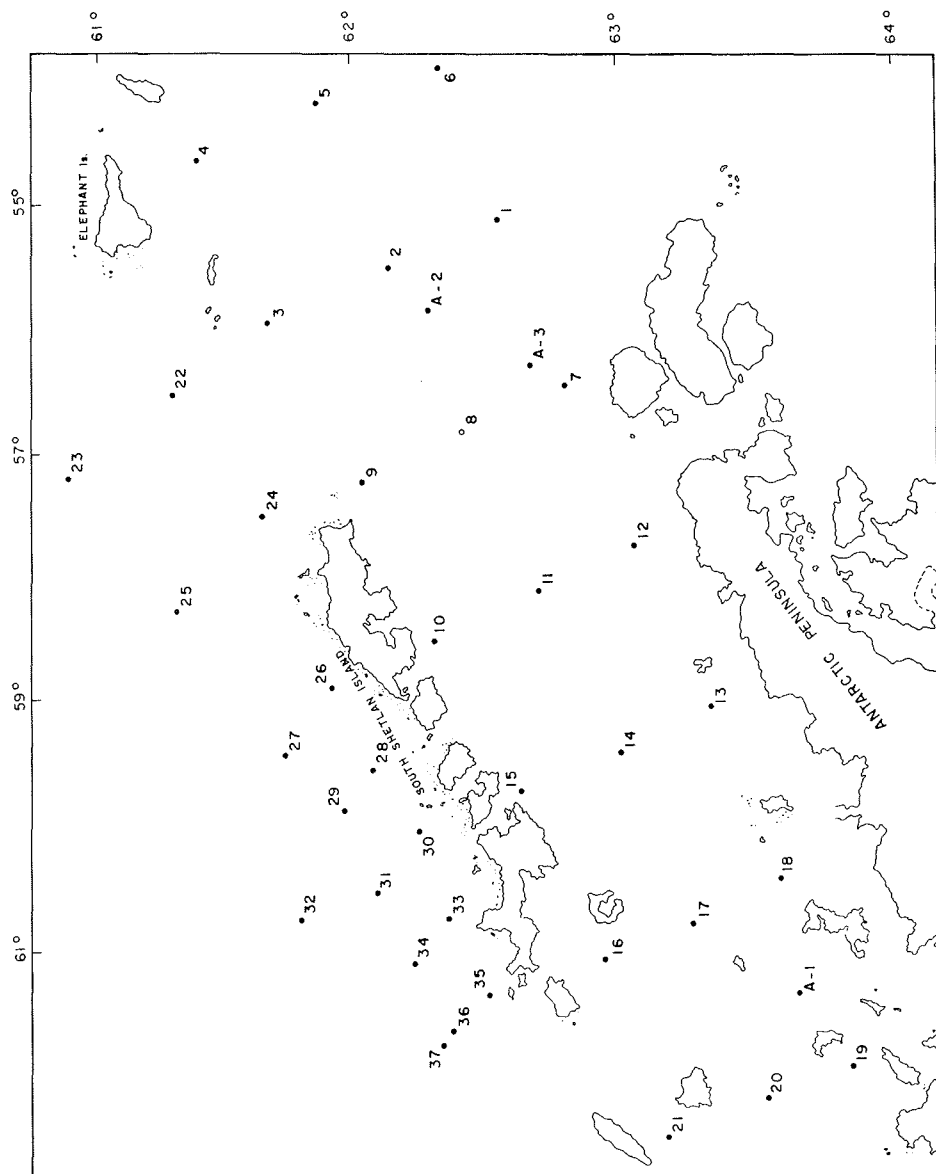

Fig. 1 Location of zooplankton sampling stations.

Results and discussion

The presence of larvae of E. superba detected during the study correspond principally to the three developmental stages denominated by calyptopis and the first two stages of furcilia. The developmental stages were dominated by calyptopis which made up more than 85% of the larvae in 32 of the 34 stations where they were found.

The absence of the first developmental stages (nauplius I and II), and the scarcity of metanauplius, which were found only in three stations (5, 9 and 12) with maximum densities of 11%, could be explained by the preferentially deep distribution during the first developmental stages, which has been described by some authors (Nast 1978, Hempel and Hempel 1978, Hempel et al. 1979). In relation to this behaviour we must emphasize that metanauplius in this study were found at sampling stations of nearly 200 metres coinciding with abrupt slopes where the depth is greater than 1,000 metres.

Furcilia occurred only in stage I and II at 21 of the 40 sampling stations, coinciding with high density centers of E. superba larvae with a relatively low abundance (Tab. 1). At 4 sampling stations located in the Drake Passage in front of the South Shetland Islands (26, 31, 32, 34) and in station 17 in the Bransfield Strait near Deception Island furcilia stages, however, made up high percentages compared to the other developmental stages (Fig. 2).

The total absence of larvae of E. superba in advanced developmental stages during the sampling period can be explained by the fact that the principal spawning time of this species is registered during summer, between January and March (Mackintosh 1972, Makarov 1976, Retamal and Quintana 1982). The larvae would have reached the more advanced developmental stages only at the beginning of autumn. The results obtained with respect to the composition of the developmental stages of

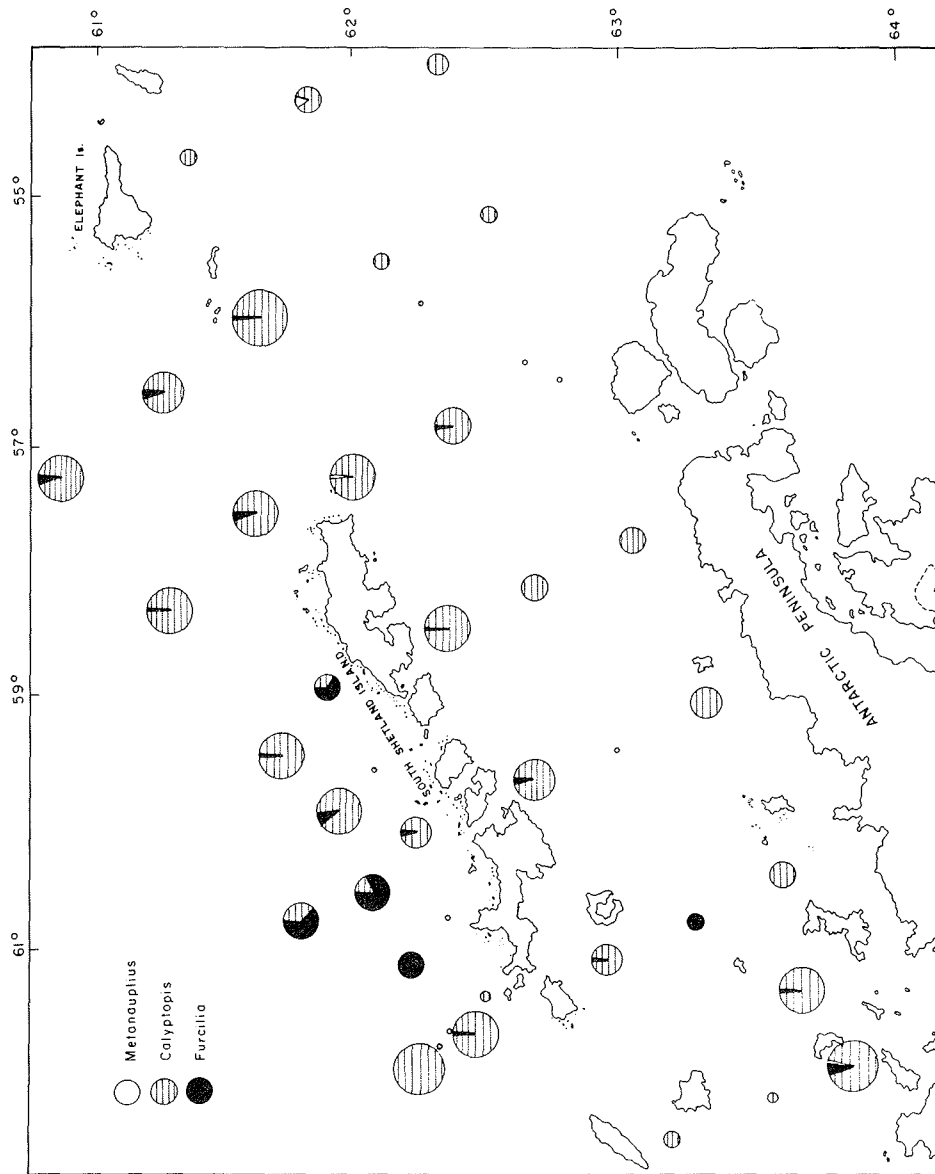

Fig. 2 Abundance ($r = \text{Log } A$) and composition of the developmental stages (%) of the *E. superba* larvae.

Table 1 Record of *Euphausia superba* larvae (N°/1,000 m³)

Stations	Developmental Stages											Total			
	Nauplius		Metanauplius	Calypptopsis			Furcilia								
	I	II		I	II	III	I	II	III	IV	V		VI		
01	-	-	-	87	-	-	-	-	-	-	-	-	-	-	87
02	-	-	-	73	-	-	-	-	-	-	-	-	-	-	73
03	-	-	-	156,197	32,057	1,917	120	359	-	-	-	-	-	-	190,650
04	-	-	-	61	12	-	-	-	-	-	-	-	-	-	73
05	-	-	13	77	-	29	-	-	-	-	-	-	-	-	119
06	-	-	-	76	15	-	-	-	-	-	-	-	-	-	91
07	-	-	-	-	-	-	-	-	-	-	-	-	-	-	-
08	-	-	-	6,684	1,089	212	60	60	-	-	-	-	-	-	8,106
09	-	-	197	8,255	9,998	888	197	-	-	-	-	-	-	-	19,535
10	-	-	-	16,266	7,325	1,046	380	-	-	-	-	-	-	-	25,017
11	-	-	-	268	65	-	-	-	-	-	-	-	-	-	333
12	-	-	-	66	49	16	-	-	-	-	-	-	-	-	131
13	-	-	-	-	164	327	-	-	-	-	-	-	-	-	491
14	-	-	-	-	-	-	-	-	-	-	-	-	-	-	-
15	-	-	-	3,981	388	129	129	78	-	-	-	-	-	-	4,705
16	-	-	-	528	68	11	11	-	-	-	-	-	-	-	618
17	-	-	-	-	-	-	-	26	-	-	-	-	-	-	26
18	-	-	-	-	254	-	-	-	-	-	-	-	-	-	254
19	-	-	110	8,462	25,495	3,077	1,429	-	-	-	-	-	-	-	38,573
20	-	-	-	-	3	-	-	-	-	-	-	-	-	-	3
21	-	-	-	73	4	4	-	-	-	-	-	-	-	-	80
22	-	-	-	2,774	6,670	295	354	59	-	-	-	-	-	-	10,152
23	-	-	-	1,183	19,958	23,587	1,341	79	-	-	-	-	-	-	46,069
24	-	-	-	6,213	16,696	3,340	1,068	-	-	-	-	-	-	-	27,317
25	-	-	-	7,296	7,242	486	81	-	-	-	-	-	-	-	15,105
26	-	-	-	24	145	72	72	217	-	-	-	-	-	-	530
27	-	-	-	7,773	19,530	360	138	-	-	-	-	-	-	-	27,801
28	-	-	-	-	-	-	-	-	-	-	-	-	-	-	-
29	-	-	-	202	6,864	3,937	1,211	505	-	-	-	-	-	-	12,719
30	-	-	-	98	456	68	17	-	-	-	-	-	-	-	639
31	-	-	-	-	203	51	1,170	51	-	-	-	-	-	-	1,475
32	-	-	-	60	156	289	817	192	-	-	-	-	-	-	1,515
33	-	-	-	-	-	-	-	-	-	-	-	-	-	-	-
34	-	-	-	-	-	-	22	110	-	-	-	-	-	-	132
35	-	-	-	-	5	-	-	-	-	-	-	-	-	-	5
36	-	-	-	8,715	30,758	695	46	-	-	-	-	-	-	-	40,214
37	-	-	-	50,910	3,874	456	-	-	-	-	-	-	-	-	55,240
A1	-	-	-	11,337	1,913	543	171	-	-	-	-	-	-	-	13,964
A2	-	-	-	-	-	-	-	-	-	-	-	-	-	-	-
A3	-	-	-	-	-	-	-	-	-	-	-	-	-	-	-

E. superba coincide well with those found by Hempel and Hempel (1978) during the German Antarctic Expedition in January/February 1976 in the same area.

The highest concentrations of these larvae, mainly represented by calyptopis I and II were detected at both extremes of the Bransfield Strait and northwest of Livingston Island at stations 3, 19, 36 and 37 (Fig. 1 and 2), with concentrations that fluctuated between 190,650 and 38,573 larvae/1000 m³. These numbers exceed those obtained by other authors from the same area, presumably due to the efficiency of the oblique sampling method with the CALCOFI net used. These high concentrations of E. superba larvae coincide with the maximum values of the zooplankton biomass detected by Mujica and Torres (1982) during the same time in the same area which indicates the dominating presence of these larvae in the zooplankton community.

In general, the study area during the sampling period, revealed two areas with high larval density; one was located between the extreme west end of the South Shetland Islands in the vicinity of Elephant Island in the Drake Passage and the northeast entrance of the Bransfield Strait. The second area was near Hoseason Island in the extreme southwest area of the Bransfield Strait (Fig. 2). These areas coincide with the highest phytoplankton densities detected by Uribe (1982) during the same expedition.

On the other hand, the areas with poor or without krill larvae located in the central and southeastern areas of the Bransfield Strait had low phytoplankton concentrations, probably due to the intense grazing carried out by adult krill (Uribe 1982). This would indicate the partial exclusion of larvae in areas with high concentrations of adult krill which confirms the results obtained by Lillo and Guzmán (1982). Consequently, the greatest diversity of zooplankton groups was detected in these areas (Mujica and Torres 1982).

Conclusions

The highest concentrations of E. superba larvae were found in the Drake Passage in front of the South Shetland Islands and the vicinity of the Elephant Island, and Bransfield Strait near Hoseason Island. They were composed mainly of calyptopis stages I and II. The maximum concentration recorded was 190,650 in 1000 m³. These areas seem to be important reproductive zones.

The first developmental stages of krill larvae were not found in the samples, probably due to their occurrence below 200 metres, which was not sampled. On the other hand, the absence of advanced stages of furciliars is attributed to the time of the sampling which coincides with the reproductive period. This may be explained by the occurrence of the first developmental stages.

Acknowledgements

The authors wish to express their gratitude to the Chilean Antarctic Institute whose financing made this project possible and to the Fisheries Development Institute for the use of its facilities in carrying out the project.

References

- Fraser FC (1936) On the development and distribution of the young stages of krill (Euphausia superba). Discovery Rep 14:1-192
- Hempel I, Hempel G (1978) Larval krill (Euphausia superba) in the plankton and neuston samples of the German Antarctic Expedition 1975-1976. Meeresforsch 26:206-216
- Hempel I, Hempel G, Baker A de C (1979) Early life history stages of krill (Euphausia superba) in Bransfield Strait and Weddell Sea. Meeresforsch 27:267-281
- Kirkwood JM (1982) A guide to the Euphausiacea of the Southern Ocean. Australia, Anare. Research Notes I:1-44

- Lillo S, Guzmán O (1982) Estimación de abundancia, distribución y comportamiento de krill mediante el empleo de métodos hidroacústicos. INACH, Ser Cient 28:23-55
- Mackintosh NA (1972) Life cycle of Antarctic krill in relation to ice and water conditions. Discovery Rep 36:1-94
- Makarov RR (1976) On the biology of reproduction of Euphausia superba Dana (Crustacea, Euphausiacea) Tr - Vses. Nauchno Issled Inst Mausk Rybn Khoz Okeanogr 110:9-85
- Makarov RR (1980) Larval development of Antarctic euphausiids. BIOMASS Handbook No 3
- Mujica A, Torres A (1982) Análisis cualitativo y cuantitativo del zooplankton antártico. INACH, Ser Cient 28:181-191
- Nast F (1978) The vertical distribution of larval and adult krill (Euphausia superba Dana) on a time station south of Elephant Island, South Shetlands. Meeresforsch 27:103-118
- Retamal MA, Quintana R (1982) Estudios biológicos básicos relacionados con la dinámica poblacional del krill Euphausia superba Dana, 1850. INACH, Ser Cient 28:193-211
- Smith PE, Richardson S (1979) Standard techniques for pelagic fish egg and larvae surveys. FAO Fish Tech Pap 175:110p
- Uribe E (1982) Influencia del fitoplancton y producción primaria de las aguas antárticas en relación con la distribución y comportamiento del krill. INACH, Ser Cient 28:163-180

Co-author's address: V. Asencio
Instituto de Fomento Pesquero
Casilla 1287
Santiago, Chile

STUDIES IN EGGS AND LARVAE OF EUPHAUSIA SUPERBA
AND EUPHAUSIA CRYSTALLOROPHIAS IN THE ATLANTIC SECTOR
OF THE SOUTHERN OCEAN

by
Irmtraut Hempel

Abstract

The paper describes the studies in geographical distribution of krill larvae (Euphausia superba) in Scotia Sea and adjacent waters, in 1975 - 1981. Striking differences in overall abundance were found. In 1981, during FIBEX, larvae were obtained in very high numbers over oceanic depths. A limited number of deep hauls revealed a vertical stratification of the eggs and early larvae of E. superba with calyptopes near the surface while eggs and nauplii were mainly below 500 m.

Two expeditions to the eastern and southern parts of Weddell Sea demonstrated the southern limits of the larvae of various species of euphausiids except the larvae of Euphausia crystallorophias which were widely distributed all along the edge of the Filchner Ice Shelf. In the southernmost part of Weddell Sea a detailed study gave indications for a developmental ascent of metanauplii and calyptopis I stages of E. crystallorophias.

Work in Scotia Sea and adjacent waters

Our work on the early life history stages of krill started with the expedition of RV "Walther Herwig" in 1975/76 followed by further five cruises (Tab. 1). Areas of study were mainly the Scotia Sea and waters adjacent to the Antarctic Peninsula. None of the expeditions was specially tailored to studies on krill larvae. The sampling was largely a by-product of general surveys of adult krill and of ichthyoplankton. The majority of samples were taken by oblique tows of the 1 m² net of 300

Tab. 1 German Expeditions on which krill larvae were taken.

1975/76	Nov. - March	RV Walther Herwig S-Georgia, Scotia Sea, S-Sandwich, northern Weddell Sea
1977/78	Dec. - March	RV Walther Herwig S-Georgia, Scotia Sea, Bransfield Str. northern Weddell Sea
1979/80	Dec. - Febr.	RV Polarsirkel S-Georgia, Bouvet Is., southern and eastern Weddell Sea
1980/81	Nov. - Febr.	RV Meteor Scotia Sea, Bransfield Str., northern Weddell Sea
	Jan. - March	RV Walther Herwig Scotia Sea, Bransfield Str.
	Jan. - Febr.	RV Polarsirkel eastern Weddell Sea
1982	Febr.+ March	RV John Biscoe Scotia Sea, Bransfield Str.
1983	Jan. - March	RV Polarstern Weddell Sea

μ m mesh size of RMT 8+1 fishing the upper 200 m. Only few deeper tows by RMT, MOCNESS or vertical closing nets were performed, as well as some neuston hauls during the first two expeditions.

Our early attempts were to find out, how and where to catch larvae. During this first phase the general distribution was established by a wide grid of stations covering the entire season. In 1975/76 only few rich samples of calyptopes were taken in Bransfield Strait in February (Fig. 1) (Hempel and Hempel 1977). The number of eggs found in February was negligible (Hempel 1979). Very early stages (eggs and nauplii) were first found in 1977/78 in the vicinity of the tip of the Antarctic Peninsula, particularly around Joinville Island in January and early February (Fig. 2) (Hempel et al. 1979). Virtually no calyptopis stages were found. In this area, two years before, spawning had been much earlier, resulting in numbers of calyptopes and even some furciliae in February. In both years early life history stages of krill were limited to Bransfield Strait and to the shelf areas around South Shetland Islands, Elephant Island and Antarctic Peninsula. Oblique hauls in Jan./Febr. 1978 which reached the near bottom layers yielded in some cases thousands of eggs while surface tows were rather poor in eggs. This confirms Marr's hypothesis that krill eggs concentrate near the bottom. In general, the number of eggs and nauplii found in 1977/78 was higher than most figures reported by earlier authors (Hempel et al. 1979).

It was only in 1980/81 that much higher numbers of up to millions of calyptopes per 1000 m³ were found. They ranged over a wide area extending from the Scotian arch into the oceanic Scotia Sea. The sampling programme of FIBEX in February 1981 ensured a good coverage of the area. All research vessels operating in the area reported very rich catches of krill larvae all along the continental slope from the southern Drake Passage to east of S. Orkney Islands. S. Rakusa-Suszczewski (pers. comm.) combined the data sets from RV "Meteor" and "Walther Herwig" (Fig. 3) (Hempel 1982) with

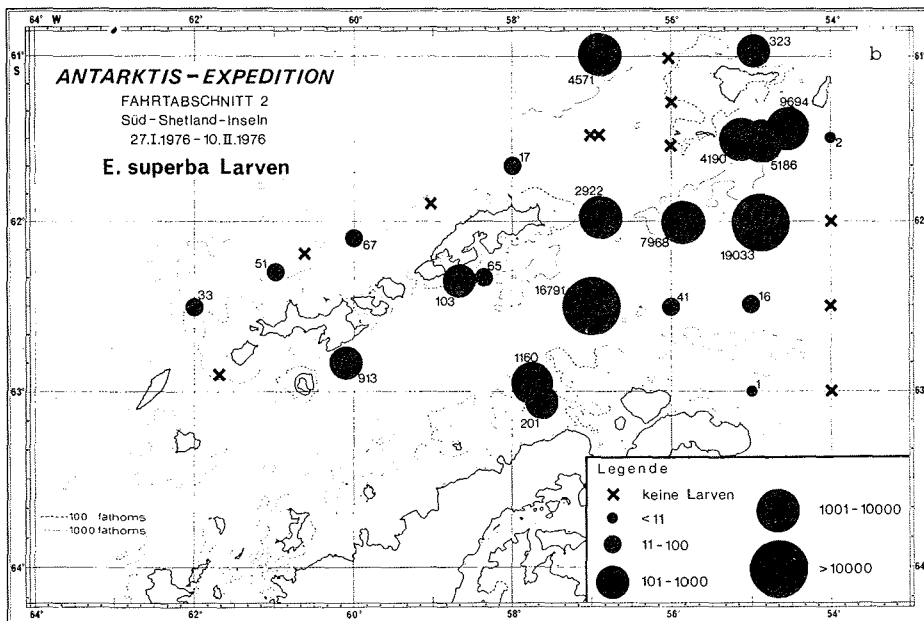
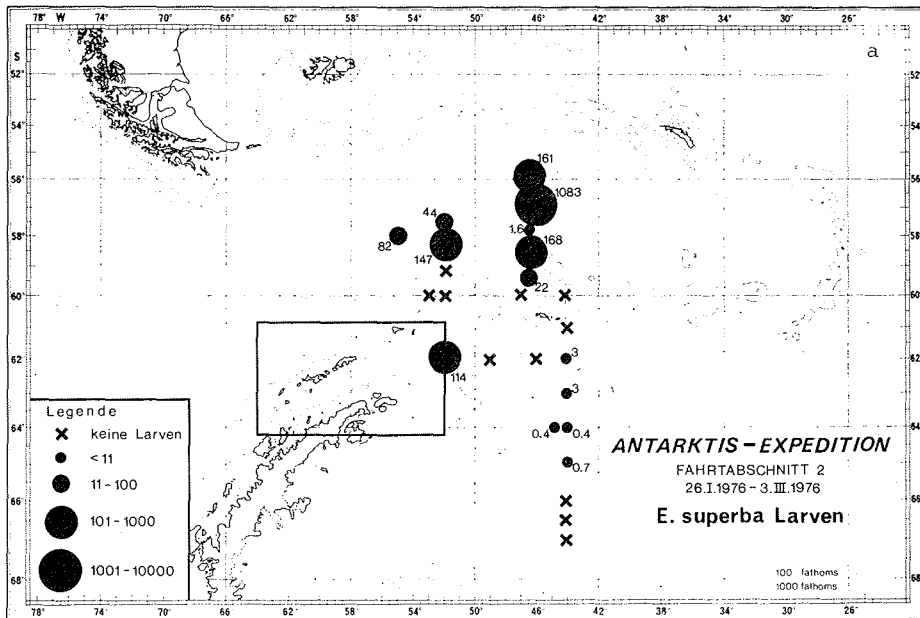

Fig. 1 "Walther Herwig". Jan.-Febr. 1976. Abundance of krill larvae in the central Scotia Sea (a) and in Bransfield Strait and adjacent waters (b).

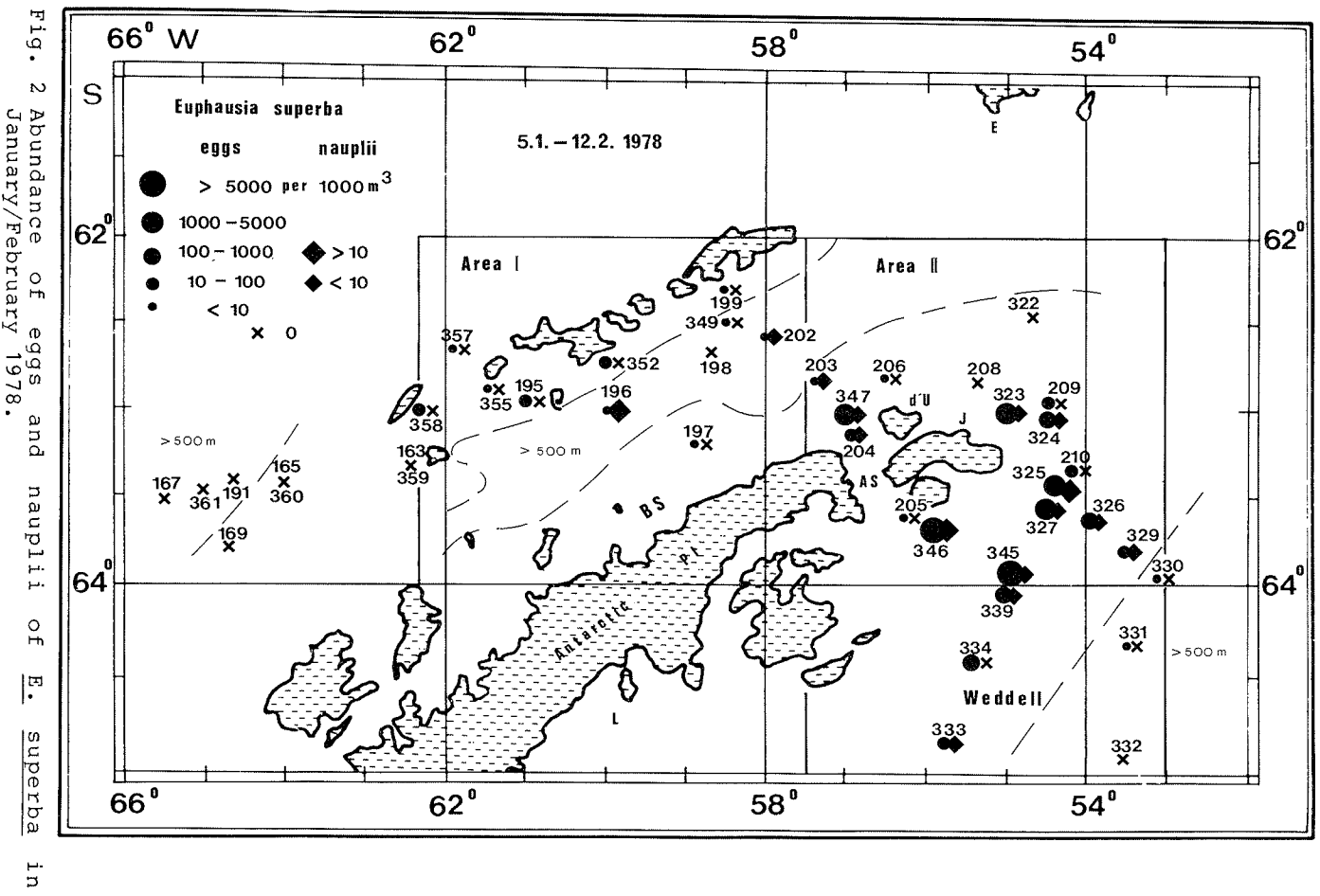

Fig. 2 Abundance of eggs and nauplii of *E. superba* in January/February 1978.

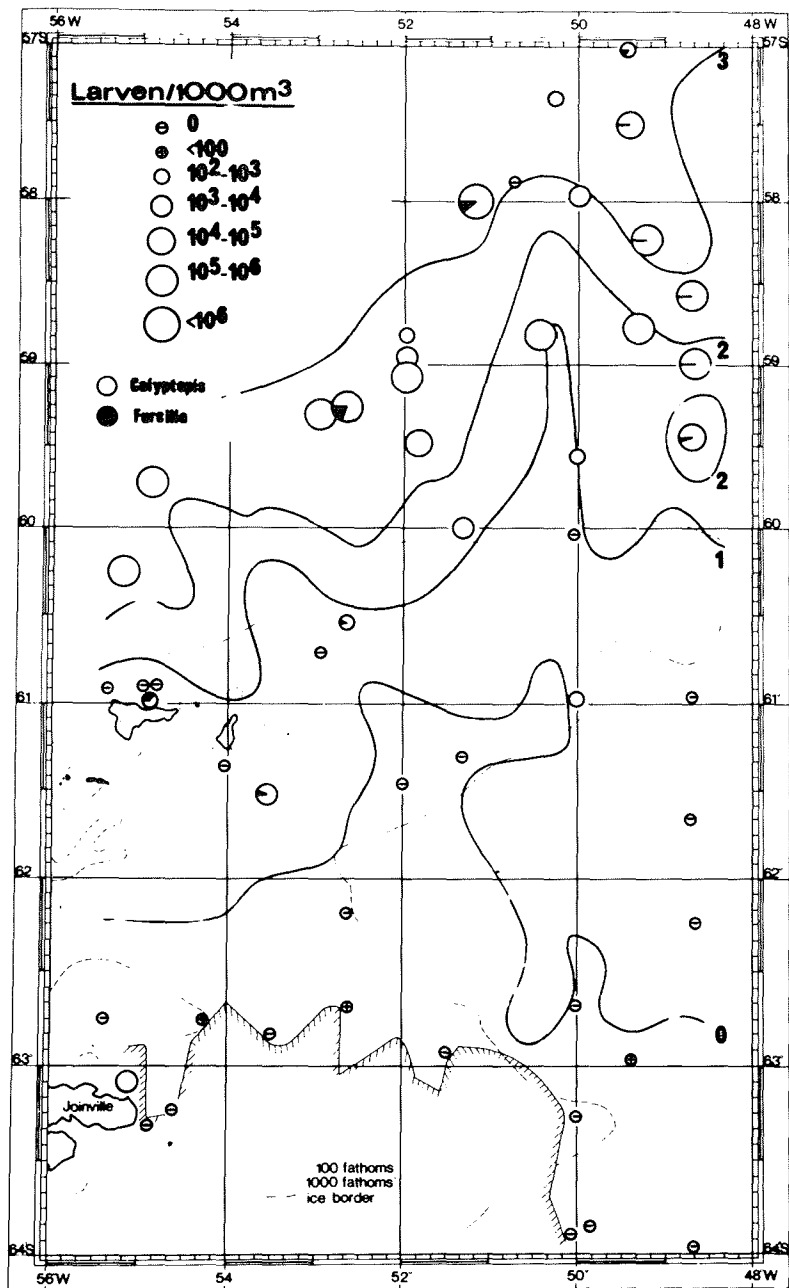

Fig. 3 Larvae of *E. superba* in the FIBEX area Jan. 1981.
RMT 1 ca. 200-0 m.
0, 1, 2, 3 = °C isotherms

those of RV "Prof. Siedlecki" (Poland) and RV "E. Holmberg" (Argentina). He found that the larvae have a much wider oceanic distribution than the adult krill which is mainly restricted to near shore waters.

The unusually high abundance of krill larvae in early 1981 shows that the reproduction in krill populations fluctuates strongly. This fact raises a number of questions which can only be answered by longterm observations:

- How often occur mass productions of krill larvae in certain areas?
- To what extent do the areas of higher concentrations shift from year to year?
- How are the variations in time and place of occurrence of early larvae related to the environment, particularly to the plankton communities and water masses?

While our knowledge on spawning and hatching in shelf areas has increased over recent years, virtually nothing is known about the fate of eggs spawned over oceanic depths. We do not know how deep these eggs will sink and at which depth the very early larval development takes place. So far no special sampling programme for collecting krill eggs at great depth in systematic way has been accomplished. This is because of the high demand of ships time for deep hauls.

A first attempt was made in the southern Scotia Sea during the second half of January 1981 where RV "Meteor" took 18 samples with vertical closing net below the standard depth of 140 m. 7 of those tows sampled from 500 to 140 m, 7 from 1000 to 500 m and 4 from 2000 to 1000 m. The mean values given in Fig. 4 show more eggs and larvae in the 500 - 1000 m layer than in the layers below or above. Only in this layer eggs were more frequent (relative and absolute). Metanauplii dominated also between 500 and 1000 m depth. Nauplii were found in highest

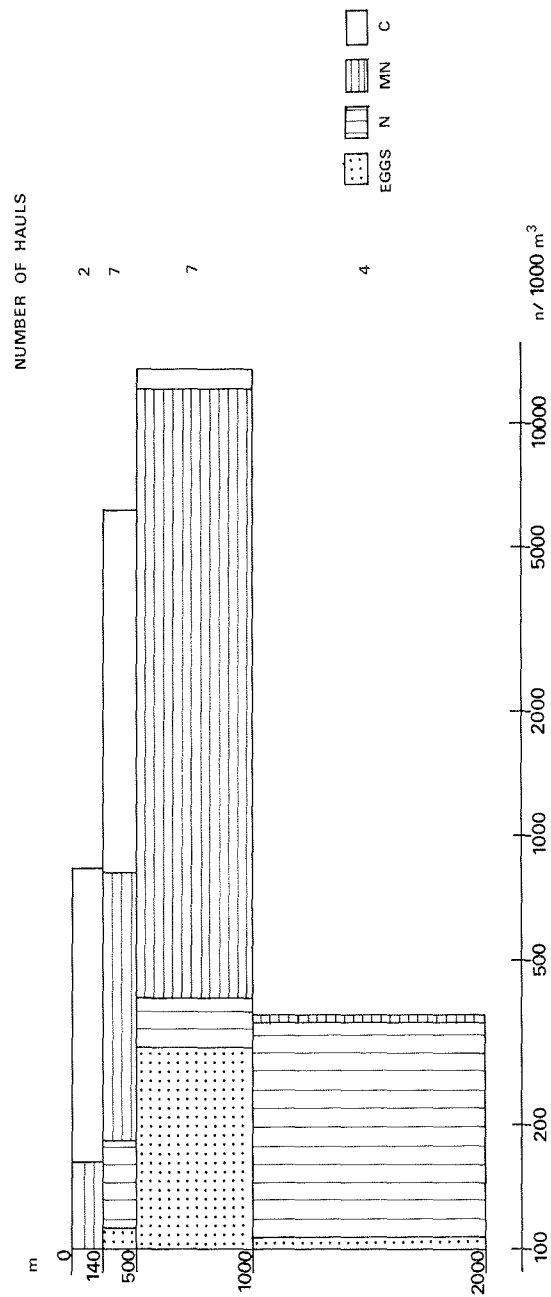

Fig. 4 "Meteor", Scotia Sea and Bransfield Str., 13-30 Jan. 1981. Vertical distribution of *E. superba* larvae. Mean number per depth layer.

numbers in the 1000 - 2000 m layer, their number decreased at the upper layers. Calyptopes show the opposite vertical distribution with almost no specimen below 500 m but rich numbers in the upper 500 m. These "Meteor"-samples confirm for oceanic waters Marr's (1962) hypothesis of a developmental ascent during the early life history of E. superba.

In addition, Marschall and Hirche (in press) have demonstrated that krill eggs are mechanically very fragile. Presumably only a small fraction of the eggs present at great depth will be recovered in the samples when they reach the laboratory.

Marschall (1983) compared size, density and sinking rate of the eggs of E. superba, Meganyctiphanes norvegica and Thysanoessa raschii. The eggs of Antarctic krill have the highest daily sinking rate of more than 200 m. From his own experimental data on incubation time in E. superba at different temperatures, Marschall (pers. comm.) estimated that krill eggs will normally not sink for more than 2000 m before hatching. His studies on the development of the mouth parts and alimentary tract revealed that feeding can commence at the CI or CII stage of E. superba.

Work in the eastern and southern Weddell Sea

In 1979/80 and 1980/81 two expeditions by RV "Polarsirkel" were performed for the establishment of the German Antarctic Station "Georg-von-Neumayer". The first expedition went from Atka Bay to the base of the Peninsula all along the ice shelf of the eastern and southern Weddell Sea. Plankton sampling and bottom trawling were carried out wherever time and ice conditions permitted. The area at 50°W off Filchner Ice Shelf was repeatedly sampled ("Filchner box").

In the following year the vessel reached only Gould Bay off Berkner Island. Plankton sampling in the Weddell Sea was restricted to the polynia between Halley Bay and Gould Bay from 3-16 January 1981. Therefore any comparison with the first cruise is limited to this area.

A summary of the results of the first expeditions may be quoted from Hempel and Hempel (1983). "In Weddell Sea only three species occur (Fig. 5): Thysanoessa macrura, E. superba and E. crystallorophias. T. macrura was present in most samples between South Georgia respective Bouvet Island and 73°S, i.e. to the eastern entrance of Weddell Sea where this species has its southern boundary of larval distribution with the exception of one locality even further south near the Filchner Depression. The occurrence of E. superba larvae en route was limited to the north eastern approaches of the Weddell Sea south of 67°S. The absence of E. superba larvae in the area of South Sandwich Islands and eastward agrees with the results of the survey in March 1976. Into the Weddell Sea E. superba larvae can be followed to 76°S with fair numbers of calyptopes southwest of Cape Norwegia, and fewer further south. E. superba appeared only in the second half of February, while samples taken six weeks earlier in the same area were negative. Therefore we may conclude that E. superba larvae occur late in the season and only in the eastern part of the southern Weddell Sea. The Filchner Depression is the south western boundary for the larvae of this species. The absence of nauplii of E. superba from all samples might be due to the relatively shallow sampling depth.

Larvae of E. crystallorophias occurred already north of the Antarctic Continent up to 65°S. The oceanic distribution of the larvae in this area is in contrast to the neritic distribution of adult E. crystallorophias. Along the ice shelf, E. crystallorophias had by far the widest distribution of all euphausiid larvae. They were present in considerable numbers in all samples, even to the far West near the Peninsula. Like E. superba also the larvae of E. crystallorophias were

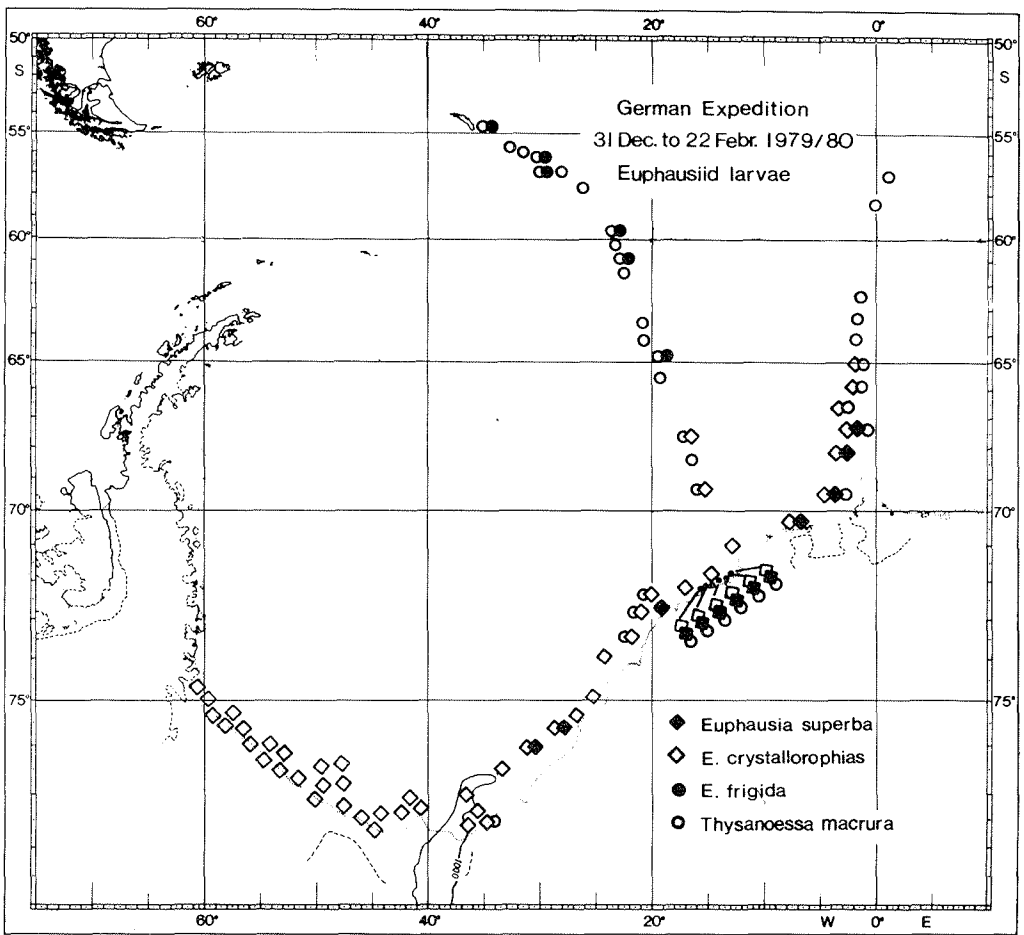

Fig. 5 Distribution of early life history stages of euphausiid larvae in 1979/80.

particularly abundant southwest of Cape Norwegia where the shelf is very narrow and the 2000 m isobath is near the ice shelf."

The results of the 1980/81 expedition are summarized in Hempel et al. (1983) as follows:

"In early/mid January 1981 sampling between Halley Bay and Gould Bay revealed eggs, nauplii and metanauplii of E. crystallorophias only. In 1980 larval development had been somewhat more advanced with calyptopis stages already occurring on 4 January off Halley Bay and on 5 January in Gould Bay. E. superba was absent in the area in 1981 just as in January 1980. The small concentration of T. macrura found at Filchner Depression in 1980 was not met again in 1981."

The occurrence of E. crystallorophias larvae on both the westward and eastward leg of the first expedition offered the opportunity for description of larval development of this species on a regional basis (Fig. 6) (Hempel and Hempel 1983). With regard to E. superba Fig. 6 does not permit an estimate of developmental rate as krill larvae occurred only late in the season.

For a study of the vertical distribution of plankton including larvae of E. crystallorophias two sets of samples are available from the Filchner box 17-21 January 1980 and from Gould Bay 7-15 January 1981. In 1980 samples were taken by a vertical net with closing device from near bottom at 250 m to the surface in 4 steps. The 1981 samples came from an open vertical net without closing device which was lowered to various depth zones (50-400 m) and hauled to the surface.

Fig. 7 indicates higher concentrations of larvae in the 100-25 m layer. Particularly CI stages are considerably more abundant in this layer than further down, while vertical differences in abundance of the naupliar stages are rather small. A lower abundance in the uppermost 25 m is noticeable.

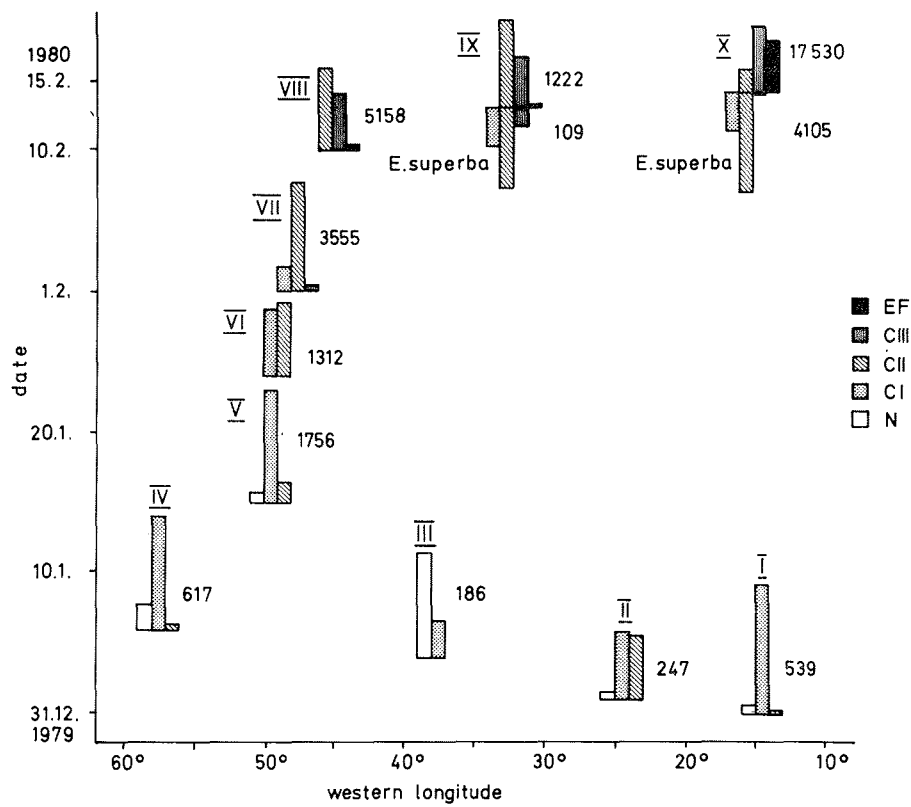

Fig. 6 Space/time diagramme of percentage mean distribution of developmental stages of *E. crystallorophias* and *E. superba* in groups of stations. Numbers refer to average abundance of larvae per 1000 m³.

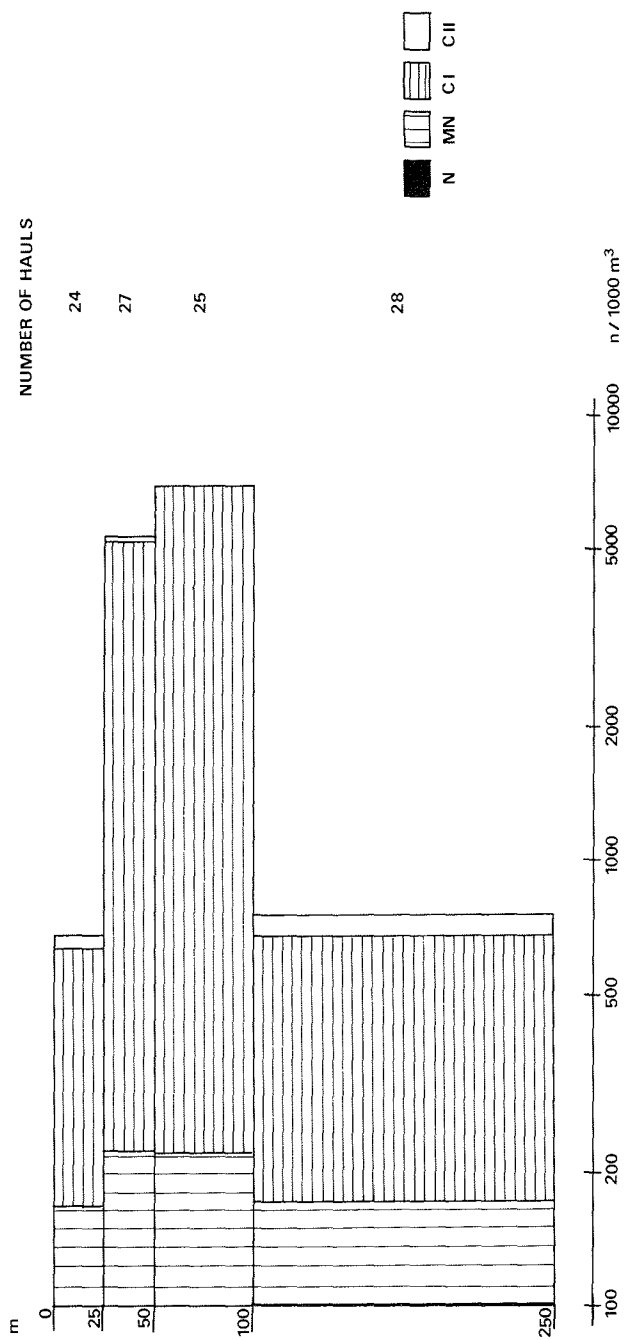

Fig. 7 "Polarsirkel", S-Weddell Sea, Stn. 60, time station 17-21 Jan. 1980. Vertical distribution of *E. crystallorophias* larvae. Mean number per depth layer.

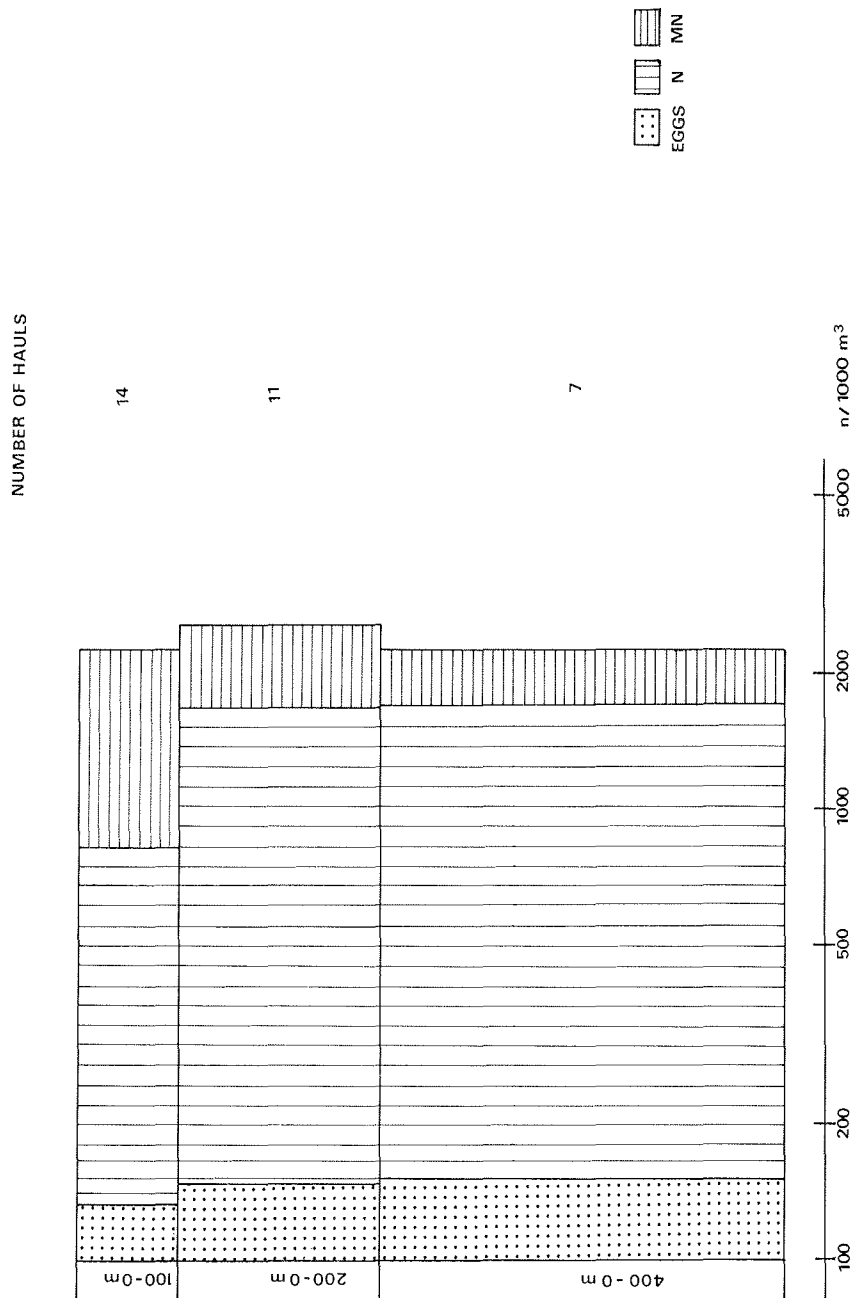

Fig. 8 "Polarsirkel", S-Weddell Sea, Stn. 103-116, 7-15 Jan. 1981. Vertical distribution of *E. crystallorophias* larvae.

In the samples of 1981 (Fig. 8), calyptopes are missing and nauplii are dominant. This difference in age structure can not be attributed to the difference of one week in sampling dates, but at least partly to a delay in spawning. The interpretation of the vertical distribution is limited by the fact that the samples were not taken by a closing net. It seems that metanauplii are more abundant in the upper 100 meters than deeper down, both in absolute and relative figures. Egg abundance does not differ much with depth, although a slight preference for the deeper layers may be observed.

Marschoff (pers. comm.) has treated the data of 1980 and 1981 statistically. He also found an upward shift of the mean depth of larvae with developmental stage from nauplius to metanauplius in 1981 and from metanauplius to calyptopis in 1980. No diurnal vertical migration was observed by the statistical analysis.

References

- Hempel I (1979) Vertical distribution of eggs and nauplii of krill (Euphausia superba) south of Elephant Island. Meeresforsch 27:119-123
- Hempel I (1982) Zur Verbreitung der Brut von Euphausia superba in der mittleren Scotia See während FIBEX 1981. Arch Fisch Wiss 33 (Beih 1):89-95
- Hempel I, Hempel G (1977) Larval krill (Euphausia superba) in the plankton and neuston samples of the German Antarctic Expedition 1975/76. Meeresforsch 26:206-216
- Hempel I, Hempel G (1983) Distribution of euphausiid larvae in the southern Weddell Sea. Meeresforsch 29:253-266
- Hempel I, Hempel G, Baker A de C (1979) Early life history stages of krill (Euphausia superba) in Bransfield Strait and Weddell Sea. Meeresforsch 27:267-281
- Hempel I, Hubold G, Kaczmaruk B, Keller R, Weigmann-Haass R (1983) Distribution of some groups of zooplankton in the inner Weddell Sea in summer 1979/80. Ber Polarforsch 9:1-35

Marr J (1962) The natural history and geography of the Antarctic krill (Euphausia superba Dana). Discovery Rep 32:33-464)

Marschall HP (1983) Sinking speed, density and size of euphausiid eggs. Meeresforsch 30:1-9

Marschall HP, Hirche HJ (in press) Development of eggs and nauplii of Euphausia superba. Polar Biol

GEOGRAPHICAL ASPECTS IN THE INVESTIGATION OF
THE LIFE HISTORY OF EUPHAUSIA SUPERBA DANA

by

R.R. Makarov

Introduction

Features of the life history of Euphausia superba have in recent years been the subject of many investigations. A comprehensive knowledge has been obtained on the growth and seasonal development of E. superba. Populations of E. superba include three principle groups (generations): larvae, juveniles and adults. The evidence that breeding can take place in at least two successive seasons (Makarov 1975) confirms the presence of one or more generations in the population (at least in certain years). The seasonal fluctuations of plankton in the Southern Ocean are responsible for temporary limits to the breeding season and also influence the growth rate in euphausiids. It is due to this that distinct size groups emerge which correspond to different generations of the population of euphausiids. The situation is, however, even more complex in practice. In samples taken from different areas the size composition of euphausiids varies considerably. The increase in the number of size-age groups in populations of E. superba inhabiting different areas was investigated by Mackintosh (1972) who found changes with latitude. This is one of the reasons why the number of size groups may increase. The second reason is the drift of euphausiids. Even if they have a similar age structure; when transported to one locality from different areas individuals may differ by modal values of the size groups, if prior to that, their developmental pathway occurred under quite different conditions. From the above it becomes obvious, that the analysis of the structure of populations and the distinguishing of generations are difficult.

An attempt is made below, to discuss both types of influences in detail and to review methods to eliminate or reduce to a minimum difficulties experienced in analysing the biostatistical data on E. superba populations.

Seasonal influences on the life history of E. superba

The onset of the vegetative season and its duration in the Southern Ocean differ with latitude. Latitudinal zones characterized by deviations in seasonal timing of plankton development are distinguishable (Hart 1942, Voronina 1971). The author's efforts were aimed at substantiating a so-called phenological wave in the development of plankton. No doubt, similar phenomena also occur in the Northern Hemisphere, but it is more distinct in the Antarctic. This is due to the fact that the above mentioned tendencies remain undistorted over a vast area of the Southern Ocean.

Although different latitudinal zones can be identified, Voronina (1971) for example, interprets the movement of the phenological wave as a continuous process. However, as will be shown later, the process is more complicated than at first assumed.

Reviewing the peculiarities in size composition of E. superba with regard to latitude, Mackintosh (1972) found distinct changes in the growth rate of E. superba in relation to latitude. According to his observations, the growth rate of euphausiids is slower in high latitudes with the result that they attain sexual maturity after longer periods. Therefore, populations of E. superba living under such conditions may include several generations, and specimens of an intermediate size between two generations are always present in populations of E. superba at all latitudes. This observation is not in agreement with that of Ivanov (1970) who found that size groups were similar in all populations while Aseev (1979) believes that several groups occurring in an area represent a row of successive generations. This concept leads to obvious

overestimation of age and life span of E. superba. The concept of Mackintosh (1972) fits into the above mentioned theory concerning the path of the phenological wave and differences in the seasonal timing of plankton development in different latitudes.

Large-scale investigations carried out in various localities of krill have indicated that our understanding of a gradual shift in the seasonal phases in plankton or in variations in the size composition of populations of E. superba could be improved. Hart (1942) and Voronina (1971) distinguish between phenological areas on the one hand, and stress the continuity and gradualness of the course of the phenological wave from the Antarctic Convergence to the Antarctic coast on the other. It is quite evident, however, that if such zones do exist, the course of the phenological wave one may expect would be stepwise and not gradual. Such discontinuities in the phenological development of plankton, that is, a sudden abrupt rejuvenation in the age composition of a population, particularly of larval euphausiid, have been found (Makarov 1977, 1979b, Vladimirskaia 1978). Discontinuities were observed in areas where waters of different types converge, e.g. water of the Antarctic Circumpolar Current and water of the high-latitudinal origin which forms secondary frontal zones. A good example of such a zone is the Scotia Sea (Bogdanov et al. 1969, Solyankin 1969). Similar zones are believed to exist in other areas of the Southern Ocean. They are situated at various distances from the Antarctic continent and, as a rule, closer to it than the secondary frontal zone of the Scotia Sea (Maslennikov 1980) though this is not always so. With reference to the Scotia Sea it can be shown (Vladimirskaia 1975, 1978, Makarov 1977, 1979), that plankton (both copepods and larval euphausiids) in the Weddell Sea, i.e. in the water of high-latitudinal modification is at an earlier stage of seasonal development than plankton in the Antarctic Circumpolar Current water (of low-latitudinal modification) flowing north. This is clearly noticeable in organisms which undergo rapid transition. Processes proceeding at a slower rate, e.g.

the three-year life span in E. superba, respond to such effects more gradually. Thus the modal values of sizes of individuals inhabiting each type of water differ, although they belong to generations of the same age.

Euphausiids of the Weddell Sea were found to be smaller in size (in similar age groups) than those of the Antarctic Circumpolar Current (Makarov 1980). This is explained by the fact that accelerated growth rate of euphausiids in the Weddell Sea begins later than in the Antarctic Circumpolar Current. In some localities specimens from all the groups are intermingled and under such conditions size groups encountered cannot be interpreted as belonging to separate generations. It is evident, that populations of plankters inhabiting each type of water mass are, on the whole, characterized by their own seasonal rhythm of development.

In the example mentioned, specimens of E. superba in the Weddell Sea and water of the south periphery of the Antarctic Circumpolar Current have already drifted over low latitudes for a long time and do not reveal a complicated age composition. Such a phenomenon may be expected in areas lying in higher latitudes. The investigations made in the Lasarev Sea have provided an opportunity to demonstrate this. In this area there is a boundary between waters of two modifications, the Antarctic Circumpolar Current (a high-latitudinal modification) and Weddell Drift (a high-latitudinal modification transformed as a result of a long-term drift in low latitudes) and the interaction between them is rather weak (Makarov and Solyankin 1982). It is in the water of the Antarctic Circumpolar Current that a definite intercalary group within the population of E. superba was found, with modal sizes of 40-44 mm. The group occupies an intermediate position between two groups: juveniles 28-37 mm and mature euphausiids 48-50 mm long (March 1981). Further to the north juveniles again occur over the Maud Rise, but they were not seen in the middle latitudes of the Lasarev Sea. The juveniles and mature adults inhabiting the same water belong to the group transported with

the Weddell Drift. The sizes of juveniles and adults are similar in both areas. The populations differ only due to the presence of an intercalary group characterizing the age structure of euphausiids brought over with the Antarctic Circumpolar Current.

During the period of observations, the breeding of E. superba occurred in the Lasarev Sea. The similar physiological condition of females and similar age composition of larvae (they were distributed in two isolated zones in the north and south; individuals not older than calyptopis stages I and II were predominant) indicates that the breeding in both populations took place at similar dates and in a shorter breeding season. Such a discrepancy in the size-age structure and similarity in the breeding timing of specimens from both populations may be explained by the following circumstances: If the group in the Antarctic Circumpolar Current originated there then the other group which is moving with the Weddell Drift has drifted here from lower latitudes. The given age composition of euphausiids was formed there and is characterized by a certain degree of inertness and cannot undergo very rapid changes when euphausiids are transported to higher latitudes. On the other hand, the breeding timing depends firstly, on maturation conditions and secondly, on the availability of appropriate feeding conditions for larvae. The total latitudinal extension of the region involved is not so great (360 miles) therefore euphausiids exist in almost similar conditions. In particular low-latitudinal specimens find themselves under conditions of high latitudes which affect the reproduction timing of specimens from both subpopulations in the same way. It is the great extent of lability of the breeding ecology that is responsible, in the long run, for such similarity in the reproductive state of adults and larvae of E. superba, regardless of their origin. In contrast zones of lower latitudes, in the Scotia Sea the secondary frontal zone in particular, the situation is somewhat different. As was observed, the size of specimens in populations of E. superba inhabiting the waters of the Weddell Drift and Antarctic

Circumpolar Current, differed. The intercalary group was not always found in the population of southern euphausiids. The difference in the breeding timing is more distinct (breeding in the southern waters begins later). In the area off the Antarctic Peninsula the situation appears to be somewhat different. This is due to a peculiar position of the peninsula itself in relation to latitudinal zones. Owing to a very complicated hydrological pattern various combinations may be encountered here which manifest themselves in the occurrence of several waters of different origin (modifications) (Makarov and Maslennikov 1981, Makarov et al. 1982). The interpretation of peculiarities of the size composition which varies substantially from locality to locality (Kock and Stein 1977/78, Makarov 1979a, Nast 1982, Siegel 1982) is very difficult due to the mosaic distribution of background characteristics. We will not relate to details of the situations, but, it is clear that they would be interpreted better if our understanding of processes in simpler cases could be more thorough, particularly in regions similar to the two under discussion.

Thus, euphausiids of different origin in different latitudes, but living side by side are characterized by different features of their life cycles. By that, some biological characteristics which are of conservative character change insignificantly whereas others are very liable to alterations.

The size composition of euphausiids and problems of ageing

In general, ageing in crustaceans is very difficult because there are no structures in these animals allowing for direct determination (Hartnoll 1982). Until now the only accepted procedure of this analysis is the comparison of size groups by modal values of sizes and corresponding identification of size groups with age groups (generations).

The available methods of graphic, mathematical or any other division of groups (Cassie 1954, Harding 1949, Mauchline 1976, Hartnoll 1982) in complicated variation curves, allow the identification of groups with some or other degree of confidence, but they give no indication of the absolute age of specimens examined.

A method should be developed to compare complicated curves of size composition in euphausiids segregated by mechanical influence of water dynamics, with variation curves characterizing euphausiids distributed beyond the area of segregation. Variation curves have, as a rule, a simpler pattern. The success of the procedure depends, on to what extent all size groups of euphausiids present in a given area are covered in a "pure form". This requires extensive surveys (Makarov 1979a). At the same time the frequency of occurrence of size groups should be assessed. It is quite clear that groups occurring seldomly, especially among juveniles, can be interpreted as separate generations with less confidence than groups occurring more regularly. The young individuals grow fast and their increment depends on living conditions in their habitat. Since phytoplankton is not evenly distributed, the feeding conditions for the young are unlikely to be uniform. Although the euphausiids are of different sizes they may be of the same age. As far as mature euphausiids are concerned differences in sizes of individuals of the same age depend primarily on living conditions which existed when these adults were juveniles, and finally, on conditions in the current season. Proceeding from the assumption that some size groups of euphausiids in a given area may be of different origin, all the conditions involved are not enough for an adequate analysis. For example, several groups of specimens occurring in the secondary frontal zone of the Scotia Sea in certain years belong to different populations (Makarov 1979a, Makarov and Maslennikov 1980). It means that the analysis of the size-age composition of krill should be made together with the study of hydrological data and primarily with the study of

distribution of waters of different modifications in the region involved. This will provide a basis for consideration of the origin of krill in association with waters.

The distinguishing of modifications is a rather difficult aspect of investigations, but it is absolutely necessary (Maslennikov 1980, Bogdanov et al. 1980). They are distinguished not only by the vertical stratification of waters, but also by hydrochemical characteristics, such as the ratio of SiO_2/P (Arzhanova and Mikhajlovskij 1980). Of significance are planktological data. As was mentioned above, populations of mass copepods are characterized by different age composition in waters of different types (Vladimirskaya 1978). Widely-distributed larvae of Thysanoessa macrura are very indicative (Makarov 1979, Makarov and Maslennikov 1980). And finally data on phytoplankton are also very important (Vladimirskaya et al. 1976).

Only after a thorough analysis of the distribution and association with waters of different modifications, can the size groups be identified by ages. The procedure is still very difficult. The recent data on the cessation of growth in smaller E. superba under unfavourable feeding conditions, especially in winter (McWhinnie et al. 1979, Ikeda and Dixon 1982) introduce new difficulties. If this phenomenon is found to occur in the field (until now it was observed only in the aquarium) it will introduce difficulties and throw a new light on the methods of ageing E. superba. The recent investigations have confirmed the phenomenon of juvenation of individuals and their repeated breeding in the following year (Makarov 1975), which also affects the results of the analysis.

Despite these difficulties, however, investigations should go on. The search for various biochemical tags (Ettershank 1982) seems very promising. The more extensive the explorations, the more reliable will be the results obtained. Cooperation and

joint expeditions will be very useful to solve problems such as ageing of generations of E. superba under variable Antarctic environmental conditions.

References

- Arzhanova NV, Mikhajlovskij YuA (1980) Hydrochemical conditions in the southern part of the Sea of Scotia and in the Pacific Antarctic. In: Biological Resources of the Antarctic Krill. VNIRO, Moscow, pp 73-88
- Aseev JuP (1979) Life span in Antarctic krill. ISNIITEIRKH No. 266, 9p
- Bogdanov MF, Oradovsky SG, Solyankin EV, Khvatsky NV (1969) On the frontal zone of the Scotia Sea. (in Russ). Okeanologiya 9:989-994
- Bogdanov MA, Solyankin EV, Rodionov SN (1980) The distribution of mingled water of the secondary frontal zone in the Sea of Scotia and the distribution of krill swarms. (in Russ). In: Biological Resources of the Antarctic krill. VNIRO, Moscow, pp 28-41
- Cassie RM (1954) Some uses of probability paper in the analysis of size frequency distribution. Austr J Mar Freshwater Res 5:513-522
- Ettershank G (1982) A new look at the age structure of the Antarctic krill, Euphausia superba. BIOMASS Newsletter 4:5,9
- Harding JP (1949) The use of probability paper for the graphical analysis of polymodal frequency distributions. J Mar Biol Ass UK 28:141-153
- Hart TJ (1942) Phytoplankton periodicity in Antarctic surface waters. Discovery Rep 21:261-356
- Hartnoll RG (1982) Growth. In: Biology of Crustacea. Acad Press Inc, vol 2, pp 111-196
- Ikeda T, Dixon P (1982) Body shrinkage: a possible overwintering strategy of the Antarctic krill (Euphausia superba Dana). J Exp Mar Biol Ecol 35:141-148
- Ivanov BG (1970) On the biology of Antarctic krill Euphausia superba Dana. Mar Biol 7:340-351
- Kock KH, Stein M (1977/78) Krill and hydrographic conditions off the Antarctic Peninsula. Meeresforsch 26:79-95

- Mackintosh NA (1972) Life cycle of Antarctic krill in relation to ice and water conditions. *Discovery Rep* 36:1-94
- Makarov RR (1975) A study of repeated maturation of females in euphausiids (Eucarida, Euphausiacea). *Zool J* 54: 670-681
- Makarov RR (1977) Larval distribution and some aspects of reproduction ecology of Euphausia frigida Hansen, 1911 (Crustacea: Euphausiacea) in the southern part of the Scotia Sea. (in Russ). *Okeanologiya* 17:324-332
- Makarov RR (1979a) Size composition and conditions of existence of Euphausia superba Dana (Crustacea: Euphausiacea) in the eastern part of the Pacific sector of the Southern Ocean. (in Russ). *Okeanologiya* 19:878-884
- Makarov RR (1979b) Larval distribution and reproductive ecology of Thysanoessa macrura (Crustacea: Euphausiacea) in the Scotia Sea. *Mar Biol* 52:377-386
- Makarov RR (1980) The study of the composition of population of Euphausia superba Dana, 1852. (in Russ). In: *Biological Resources of the Antarctic Krill*. VNIRO, Moscow, pp 89-113
- Makarov RR, Maslennikov VV (1980) Distribution and age composition of larvae of Thysanoessa macrura G.O. Sars 1885 in relation to hydrological conditions in the Pacific sector of the Antarctic. (in Russ). *Biol Morya, Vladivostok* 4:8-17
- Makarov RR, Maslennikov VV (1981) Ecology of larval development of the crustacean Euphausia superba. Change in dominant larval forms as a function of environmental conditions. *Mar Ecol Prog Ser* 4:265-271
- Makarov RR, Solyankin EV (1982) Living conditions and structure of the population of Euphausia superba in the Lasarev Sea area. *Tez dokl III Vses Konf "Problemy ratsional" nogo ispol'zovaniya promyslovykh bespozvochnykh*, 61-62. Kaliningrad, AtlantNIRO
- Makarov RR, Maslennikov VV, Movchan OA, Solyankin, EV (1982) Oceanographic conditions and regional peculiarities of seasonal successions in plankton from the coastal water of Antarctic Peninsula. In: *Antarktika. Dokl mezhdomestv komissii po izucheniyu Antarktiki*. Moscow, Nauka, Issue 21, pp 101-117
- Maslennikov VV (1980) Modern concepts of the large-scale circulation of the Antarctic water and routes of mass drift of Euphausia superba. In: *Biological Resources of the Antarctic Krill*. VNIRO, Moscow, pp 8-27
- Mauchline J (1976) The Hiatt growth diagram for Crustacea. *Mar Biol* 35:79-84

- McWhinnie MA, Denys CJ, Parkin R, Parkin K (1979) Biological investigation of Euphausia superba (krill). Antarctic JUS 14:163-164
- Nast F (1982) The assessment of krill (Euphausia superba Dana) biomass from a net sampling programme. Meeresforsch 29:154-165
- Siegel V (1982) Untersuchungen an Nachlaichkonzentrationen des antarktischen Krills Euphausia superba. Arch Fisch Wiss 33:1-176
- Solyankin EV (1969) Changeability of the frontal zone position of the Scotia Sea. (in Russ). Mezhdunar Rybolov 11:42-48
- Vladimirskaya EV (1975) Zooplankton distribution in the Scotia Sea in autumn and winter. (in Russ). Okeanologiya 15:520-525
- Vladimirskaya EV (1978) Age composition of the populations of mass copepod species in the southern part of the Scotia Sea. (in Russ). Okeanologiya 18:307-311
- Vladimirskaya EV, Makarov RR, Maslennikov VV, Movchan OA (1976) Some traits of phytoplankton distribution on the southern part of the Scotia Sea in spring. (in Russ). Okeanologiya 6:1069-1975
- Voronina NM (1971) Annual cycle of Antarctic plankton. In: Beklemishev (ed) Fundamentals of the biological productivity of the ocean and its exploitation. Nauka, Moscow, pp 64-71

Author's address: R.R. Makarov
VNIRO
17, Krasnoselskaja Street
Moscow 107140
USSR

SOME PROBLEMS IN THE INVESTIGATION OF
LARVAL EUPHAUSIIDS IN THE ANTARCTIC

by
R.R. Makarov

Introduction

The many investigations on Euphausia superba have increased our knowledge of this species, but in order to obtain a comprehensive picture, other euphausiids will have to be studied. Only then can we gain a better understanding of adaptations as well as the unique biological features and life history of E. superba.

The first phase of the investigation of larval euphausiids from the Antarctic was the publication of papers by Norwegian and English workers in the 1930's (Rustad 1930, 1934, Ruud 1932, Fraser 1936, John 1936). To this list should be added a series of general planktological papers dealing with material of the Discovery Committee Expeditions in the Southern Ocean. Marr's (1962) famous monography appeared shortly after Baker's publication (1959) on life history of Euphausia triacantha. It was a decade later that modern large-scale investigations began: Mackintosh (1972) introduced a new series which is still continuing today. The work done by specialists from the USSR, Federal Republic of Germany and Poland have broadened our knowledge of Antarctic larval euphausiids studied on the basis of planktological material. Most papers are devoted to E. superba, but some deal with larvae of the species: Euphausia frigida, E. triacantha, Euphausia crystallorophias and Thysanoessa macrura. Excellent experimental work on larvae of E. superba was done by Japanese researchers (Ikeda 1981, Ikeda and Dixon 1982).

Data from a series of oceanographic surveys beginning in 1964 and made regularly in various areas of the Antarctic by R/V "Akademic Knipovich" and on material collected by R/V "Odissej" in 1981 (FIBEX) have thrown light upon many problems of the breeding ecology and larval stages of Antarctic euphausiids. Regular hauls to depths of up to 1000 m have provided collections which allow the characterization of ontogenetic migrations of all species and which can be used for description of early larval stages, e.g. nauplii and metanauplii of those species which up to now have not yet been studied. Thus only the nauplii of E. triacantha remain unknown. Observations made in different seasons have increased our knowledge of the breeding season of euphausiids.

Some results of the investigation made and presentation of problems to be solved in the future are discussed below.

General distribution of larvae and breeding grounds of euphausiids

Occurrence of larval euphausiids generally follows the pattern of the latitudinal distribution of adults, in particular their breeding localities (Lomakina 1964).

Larvae of E. frigida and E. triacantha as a rule, have a more northerly distribution than others. Larvae of E. superba and especially E. crystallorophias tend to a large extent, to remain in the south, while larvae of T. macrura occur almost at all latitudes. They are regularly encountered even in the Weddell Sea (Hempel and Marschoff 1980, Fevolden 1980). The distribution patterns of early stage larvae are similar to those of adult breeding zones.

This trend or principal pattern is substantially transformed due to peculiarities in the distribution of waters of different origin in the Southern Ocean (Bogdanov et al. 1980, Maslennikov 1980). The situation becomes extremely complicated in the Atlantic sector, in particular the Scotia Sea, due to

convergence of two Antarctic water masses, i.e. low-latitudinal (the Antarctic Circumpolar Current) and high-latitudinal (the Weddell Drift). The latter extends to the north which is reflected by the distribution patterns of larvae of all five species. At the same time it is clear that breeding zones of euphausiids and the distribution of their larvae are associated with each water mass.

Thus larvae of E. triacantha and E. frigida, representatives of low latitudes, occur in waters of the Antarctic Circumpolar Current, while the former are rarely encountered in the southern periphery when compared with the latter which are very abundant in the breeding season, which is to be expected because this species penetrates further south than E. triacantha. Larvae of E. frigida are, however, practically absent in the Weddell Drift. Larvae of T. macrura have a very wide distribution. Larvae of E. superba, primarily at early stages of development, are heavily concentrated in the zone of contact between the different water masses (Bogdanov et al. 1980). The situation changes in areas of higher latitudes. For example, larvae of E. frigida are not found frequently while larvae of E. triacantha are practically absent off the northwest coast of the Antarctic Peninsula where waters of the high latitudinal coastal origin occur (Makarov and Maslennikov 1980). Larvae of E. crystallorophias are encountered near the shore, yet they are not represented in the Scotia Sea. Larvae of T. macrura have an overall distribution, and larvae of E. superba occur near the shore in most areas. Moving southwest along the northwest coast of the Antarctic Peninsula (Makarov 1982b), the abundance of E. superba larvae increases but declines towards the southwest area. At the same time the abundance of larvae of E. crystallorophias increases. They occur in large numbers close inshore, in shallow waters of coastal archipelagos but not in the Bransfield Strait, where they are rarely encountered.

At higher latitudes, off the Antarctic continent in the Lasarev Sea, larvae of E. superba and E. crystallorophias are the only representative species. Even larvae of T. macrura distributed mainly off-shore are transported to the continent by currents. No larvae of other species are present due to waters of high-latitudinal origin, the Weddell Drift in the north and the Antarctic Circumpolar Current in the south (Makarov and Solyankin 1982).

The mixing of waters on the account of drifts plays an important role in the distribution of larvae.

As was mentioned, remarkable anomalies are observed in the Scotia Sea where the most intensive investigations were carried out. The pattern described above was registered many times. Waters of high-latitudinal origin extend far to the north. The same anomaly occurs in the area lying 30°E of the Scotia Sea (Mackintosh 1973). Further to the east the water of the Antarctic Circumpolar Current penetrates to far higher latitudes due to the Weddell Drift. Thus, it would be of interest to investigate the area using extensive transects aimed at elucidating the reasons for the changes in faunistic composition of euphausiid larvae.

E. frigida, E. triacantha and T. macrura breed over the whole area of their habitat. In this case it was found, that they occurred only in waters of different origins. A narrow localization of breeding grounds is characteristic of E. crystallorophias, which is restricted to shallow waters of the Antarctic continent. The position of breeding grounds of E. superba appears to be unique. This species forms breeding aggregations in places associated with convergence zones of waters of different origins. Such zones may be situated both in the open sea and inshore. It is significant that within such zones seasonal blooms of phytoplankton continue longer (Vladimirskaia 1982), which explains the adaptive selection of these areas for breeding zones by Antarctic euphausiids.

Breeding depth and ontogenetic migration

The investigations show, that sinking of eggs and developmental ascent of larvae are characteristic for all species of Antarctic euphausiids except for E. crystallorophias (and not, as was originally believed for E. superba only). It is between 500 and 1000 m depth that early larval stages (nauplii and metanauplii) of all species occur regularly in catches. This evidence supports the findings of Zelickman (1958) and Mauchline and Fisher (1969) who maintain that migrations are a characteristic feature of all euphausiids and not only of Antarctic species. Developmental ascent in shallow waters is suppressed as was observed off South Georgia. The existence of deep and extensive migrations has recently been shown for Thysanoessa longicaudata by Williams and Lindley (1982).

Euphausiid eggs appear to be released in the upper 0-100 m layer. The evidence is at least available for E. frigida and T. macrura off South Georgia. At night most eggs are found in this layer. It is very likely that eggs sink even further before the larvae hatch. The sinking is suspended at this moment and they do not sink further. According to McWhinnie (pers. comm.) nauplii and metanauplii do not rise in the water column. The evidence is supported by the fact that they are rarely found in layers above 500 m. It is at the stage of calyptopes I that the larvae begin to rise. These observations are different to the developmental ascent described by Marr (1962).

Thus the problem of where the larvae occur during their development remains unsolved. In most species except for E. superba and E. crystallorophias, the breeding zone is dispersed over a wide area. As far as E. superba is concerned larvae should be sought near the frontal zones.

It should be emphasized that species differences seem to be reflected by the maximum depth to which eggs can sink.

Species differences are also shown in the ontogenetic migration pattern (Makarov 1982a). With an increase in age larvae of E. superba and T. macrura rise to the surface and concentrate in the sub-surface layers, whereas larvae of E. triacantha and E. frigida tend to sink again after some time. Sinking during the larval development is found in E. crystallorophias only.

Of importance are the shallow coastal zones, where frequency of younger larvae appears to be higher. This supports the idea suggested by Marr (1962) that eggs sink to the sea bottom. No horizontal hauls in the vicinity of the sea bottom have been made up to now, and attempts should be made to do so in future.

Breeding season

The investigation of the age composition of larvae during various seasons allows the prediction of the time of reproduction. As may be expected, it depends to a certain extent on the zoogeographical position of species and probably also follows Orthon's rule (Makarov 1979a). However, such interrelationships are altered by waters of different origins. They are pronounced most distinctly in the Antarctic Circumpolar Current water while they are more obscure in the water of the high-latitudinal origin (Makarov 1979b).

Under normal conditions larvae are younger as one moves to the north (within one water type). The timing of spawning in euphausiids follows the course of the well-known Hart's phenological wave.

In some cases, however, an accelerated rate of development was observed in the coastal waters. The development begins earlier here than in the open waters further north. And it is only much further north, that the age composition of larvae is again similar to that observed in close proximity to the shore. Such a phenomenon was observed for T. macrura in the

inshore waters of the Antarctic Peninsula but does not necessarily occur regularly. The comparison shows that plankton in the inshore water may be in a more or less advanced stage of development and correspondingly, the spawning of T. macrura may be earlier or later in relation to the interaction of the inshore water and the Antarctic Circumpolar Current water. The situation may also depend on the annual melting of the ice which does not follow a fixed pattern. Hence, the spring development of life off the South Shetland Islands, in the Bransfield Strait and further to the south along the Antarctic Peninsula may begin at different times. This is very important for E. superba since one of its most important breeding grounds lies in this area (Marr 1962). The reasons for selecting such a zone, as was revealed in the study of the distribution and age composition of larvae, are not very clear and require further investigation.

Duration of the larval development

Larvae of euphausiids seem to occur in Antarctic plankton all the year round. Their abundance, age and species composition, however, changes. Thus, in October when breeding begins and larvae of E. frigida, E. triacantha, T. macrura have hatched, one year old larvae (furciliae VI) of E. superba may also occur. This is a general picture of the assessment of plankton in the Antarctic. As was said, breeding takes place in different types of water at different dates, and this reason together with the general extension of the breeding season are responsible for the presence of larval euphausiids in the Antarctic plankton all the year round.

There are no data, however, on the development time of each larval stage. This problem is very complicated and is partially solved from data available for North Atlantic species, or from experimentally hatched larvae. Mackintosh (1972) points out that low temperature retards the development of larvae of the species and it takes them three weeks to reach the stage of calyptopes I. The experiment done by Ikeda and

Dixon (1982) indicates that it takes E. superba 25 days to reach the stage of metanauplii. The same figures are obtained by Mauchline (1980). These direct or indirect assessments are doubtful, especially with regard to the effects of low temperatures, since the whole life cycle of E. superba is adapted to low temperatures.

The comparison of the age composition of larvae of T. macrura collected in the oceanic zone off the Antarctic Peninsula during two cruises (January 12 - February 5, 1976 and December 13, 1978 - January 8, 1979) showed that larvae in the early summer were at the furcilia I stage and in the late summer had attained the furcilia V stage. Thus, each developmental stage lasts between 7 and 8 days. This conclusion agrees well with data obtained for northern species (Heegaard 1948). Consequently, low temperature does not appear to affect the development of T. macrura which is to be expected, since it must be adapted to such an environment.

Because of the annual variations in the breeding season the above results need to be confirmed. Also to be considered, is the interspecific variation. For example, it may appear that owing to the large eggs, the development of E. superba is slower than that of T. macrura, although in species with low fecundity and large eggs (Nematoscelis, Nyctiphanes, Stylocheiron) the development is not slower (Ponomareva 1969, Le Roux 1973, Gopalakrishnan 1973), while on the other hand Eucarida larvae hatched from large eggs develop even more rapidly.

The ratio of egg size and body size in females of E. superba is similar to that of T. macrura. E. superba is characterized by larger sizes at all stages of the life history which reflects phylogenetic growth of this euphausiid. In fact, large larvae hatch from large eggs, the pathway of development of larvae of E. superba is, in principle, similar to that of larvae of T. macrura in terms of general morphogenesis.

Conclusions

Unfortunately it was not possible to cover the whole problem on larval euphausiids in the discussion, but it could be shown, that the aspects mentioned are strongly interlaced. It is desirable that the assessment of larval abundance, the most important aspect, should be made using an approach which takes all ecological characteristics into account.

Future investigations on larval euphausiids in the Antarctic should be conducted along the following lines:

1. Investigations on individual species in order to characterize aspects of their life history.
2. Assessment of the role of larvae in the plankton as they constitute a large portion of plankton during the spring-summer season. Larvae of E. superba are often the most abundant organisms in the plankton and may thus suppress the other species.
3. Larvae of euphausiids are very useful bioindicators with regard to geographical characteristics. For example, larvae of T. macrura occur practically everywhere, but their age composition is different in various types of water. Larvae of E. frigida are indicators of the Antarctic Circumpolar Current water. Less useful in these respects are larvae of E. superba and E. crystallorophias.

In conclusion, it should be stressed that the above discussion deals primarily with water of the Atlantic sector and adjacent areas where the Weddell Drift and position of the Antarctic Peninsula play a decisive role. In other Antarctic areas many features of the larval ecology may be similar, but the geographical aspects of, and effects, on the ecology may be modified. These areas, however, have been studied very little and this gap should be filled as soon as possible.

Investigations which are expected to be carried out in line with the SIBEX off the Antarctic Peninsula will be most useful if the geographical factor is taken into account. In view of complex conditions in the region which are expressed primarily by variable size composition of euphausiids occurring together in relatively small areas, a thorough identification of the distribution of water of different origin is important. It would also be valuable if the routes of approaching waters could be ascertained in the area to be investigated in line with SIBEX.

References

- Baker A de C (1959) The distribution and life-history of Euphausia triacantha Holt and Tattersall. *Discovery Rep* 29:309-339
- Bogdanov MA, Solyankin EV, Rodionov SN (1980) The distribution of mingled water of the secondary frontal zone in the Sea of Scotia and the distribution of krill swarms. (in Russ). In: *Biological Resources of the Antarctic Krill*. VNIRO, Moscow, pp 28-41
- Fevolden S (1980) Krill off Bouvetöya and in the Southern Weddell Sea, with a description of larval stages of Euphausia crystallorophias. *Sarsia* 65:149-162
- Fraser FC (1936) On the development and distribution of the young stages of krill (Euphausia superba). *Discovery Rep* 14:1-192
- Gopalakrishnan K (1973) Developmental and growth studies of the euphausiid Nematoscelis difficilis (Crustacea) based on rearing. *Bull Scripps Inst Ocean Univ Calif* 20:1-87
- Heegaard P (1948) Larval stages of Meganyctiphanes (Euphausiacea) and some general phylogenetic remarks. *Medd Komm Havundersøg (Ser Plankton)* 5:1-27
- Hempel I, Marschoff E (1980) Euphausiid larvae in the Atlantic sector of the Southern Ocean. *Meeresforsch* 28:32-47
- Ikeda T (1981) Metabolic activity of larval stages of Antarctic krill. *Ant J U S* 12:161-162
- Ikeda T, Dixon P (1982) Body shrinkage as a possible overwintering strategy of the Antarctic krill (Euphausia superba Dana). *J exp Mar Biol Ecol* 35:141-148

- John DD (1936) The southern species of the genus *Euphausia*. *Discovery Rep* 14:193-324
- Le Roux A (1973) Observations sur le développement larvaire de *Nyctiphanes couchii* (Crustacea, Euphausiacea) au laboratoire. *Mar Biol* 22:159-166
- Lomakina NB (1964) The euphausiid fauna of the Antarctic and notal regions. (in Russ). In: *Biological Results of the Soviet Antarctic Expedition (1955-1958)*. Nauka, Moscow Leningrad, vol 2, pp 254-334
- Mackintosh NA (1972) Life cycle of Antarctic krill in relation to ice and water conditions. *Discovery Rep* 36:1-94
- Mackintosh NA (1973) Distribution of post-larval krill in the Antarctic. *Discovery Rep* 36:95-156
- Makarov RR (1979a) Spawning terms of Antarctic euphausiids. (in Russ). *Biol Morya, Vladivostok* 3:30-38
- Makarov RR (1979b) Larval distribution and reproductive ecology of *Thysanoessa macrura* (Crustacea: Euphausiacea). *Mar Biol* 52:377-386
- Makarov RR (1982a) Ontogenetic migrations of Antarctic euphausiids. In: *Antarktika. Dokl mezhvedomstv komissii po izucheniyu Antarktiki*. Nauka, Moscow, issue 21, pp 118-132
- Makarov RR (1982b) The distribution and age composition of euphausiid larvae in the Scotia Sea and off the western coast of the Graham Land in spring and early summer. (in Russ). In: *Characteristics of the pelagic community from the Sea of Scotia and adjacent waters*. VNIRO, Moscow, pp 30-47
- Makarov RR, Maslennikov VV (1980) Distribution and age composition of larvae of *Thysanoessa macrura* G.O. Sars 1885 in relation to hydrological conditions in the Pacific sector of the Antarctic. (in Russ). *Biol Morya, Vladivostok* 4:8-17
- Makarov RR, Solyankin EV (1982) Living conditions and population structure of *Euphausia superba* in the Lasarev Sea. *Tesisy Dokl III Vsesouznoj konferentsii Probl ispolzov promys bespozvonochnykh* 61-62, Kaliningrad, AtlantNIRO
- Marr JWS (1962) The natural history and geography of the Antarctic krill (*Euphausia superba* Dana). *Discovery Rep* 32:33-464
- Maslennikov VV (1980) Modern concepts on the large-scale circulation of the Antarctic water and routes of mass drift of *Euphausia superba*. (in Russ). In: *Biological Resources of the Antarctic Krill*. VNIRO, Moscow, pp 8-27

- Mauchline J (1980) The biology of mysids and euphausiids. Adv Mar Biol 18:1-681
- Mauchline J, Fisher LR (1969) The biology of euphausiids. Adv Mar Biol 7:1-454
- Ponomareva LA (1969) Investigations on some tropical euphausiid species of the Indian Ocean. Mar Biol 3:81-86
- Rustad D (1930) Euphausiacea with notes on their biogeography and development. Sci Res Norveg Ant Exped 5:1-83
- Rustad D (1934) On the Antarctic euphausiid from the "Norvegia" Expedition 1929-30 and 1930-31. Sci Res Norveg Ant Exped 12:1-53
- Ruud JT (1932) On the biology of southern Euphausiidae. Hvalradets Skrifter 2:1-105
- Vladimirskaya EV (1982) Seasonal changes in zooplankton in the Sea of Scotia and adjacent waters. (in Russ). In: Characteristics of the Pelagic Community from the Sea of Scotia and Adjacent Waters. VNIRO, Moscow, pp 48-60
- Williams R, Lindley JA (1982) Variability in abundance, vertical distribution and ontogenetic migrations of Thysanoessa longicaudata (Crustacea: Euphausiacea) in the North-Eastern Atlantic Ocean. Mar Biol 69:321-330
- Zelickman EA (1958) Material on the distribution and breeding of euphausiids off Murman. Trudy Murmansk Biol Stat, vol 4, pp 79-117

Author's address: R.R. Makarov
VNIRO
17, Krasnoselskaja Street
Moscow 107140
USSR

SINKING SPEED OF KRILL EGGS AND
TIMING OF EARLY LIFE HISTORY STAGES

by

Hans-Peter Marschall

Summary of the lecture

During the Joint Biological Expedition on RRS "John Biscoe" in February 1982 sinking speed and density of Euphausia superba eggs was measured in the laboratory (Tab. 1; Marschall 1983).

Tab. 1 Mean sinking speed (U) of Euphausia superba eggs. sd=standard deviation, n= number of eggs

	U mday ⁻¹	sd +mday ⁻¹	range mday ⁻¹	n
T= 1.8°C S= 33.67‰/∞	211.3	38.3	141-320	14
T= 1.9°C S= 33.93‰/∞	232.5	32.6	172-315	19

Applying the Navier-Stoke's equation

$$U = \frac{2 r^2 g (\rho' - \rho)}{9 \eta} \quad (1).$$

(U = sinking speed; r = radius of a sphere; g = earth acceleration; ρ' = density of a sphere; ρ = density of the fluid; η = viscosity of the fluid)

density of the krill eggs was calculated (Tab. 2; Marschall 1983).

Tab. 2 Size, sinking speed and density of *Euphausia superba* eggs.

$T=1.9^{\circ}\text{C}$, $S=34.16^{\circ}/\text{oo}$, $\rho=1.0273 \text{ gcm}^{-3}$,
 $\eta=0.01766 \text{ gcm}^{-1}\text{s}^{-1}$

OD=outer diameter, U=sinking speed, ρ' =density of a sphere, sd=standard deviation, n=number of intervals sinking speed was measured for

Run No.	OD cm 10^{-3}	U cm $^{-1}$	sd +cm $^{-1}$	U md $^{-1}$	ρ' gcm $^{-3}$	n
1	60.1	0.2552	0.0090	221	1.0502	4
2	60.2	0.2673	0.0044	231	1.0512	4
3	58.3	0.2562	0.0202	222	1.0507	4
4	59.6	0.2347	0.0035	203	1.0487	4

From these results it is obvious that krill eggs will not become buoyant at any depth, as suggested by Voronina (1974).

Timing of the early life history stages was also determined during the above mentioned expedition (Tab. 3; Marschall and Hirche in press).

Tab. 3 Timing of developing krill eggs and larvae at $1,5 \pm 0,5^{\circ}\text{C}$.

Days after spawning	Developmental stage
1,2	gastrulation
2,4	limb-buds visible
4,3	nauplii twitch within the egg
5,3	50 - 60% hatched, most of the remained eggs just before hatching
7,2	nauplii with one pair of spines
10,3	nauplii with three pairs of spines
13,3	some nauplii moulted to metanauplii
19,0	still metanauplii

After last control beaker broken due to stormy weather

Within the two nauplius stages a successive development of the morphological characteristics could be observed. Although we looked carefully for exuviae none was found. It seemed that no

moulting has taken place during the development from first to second nauplius. Between nauplius and metanauplius stage moulting was observed (Marschall and Hirche in press).

Assuming that the females shed their eggs near the surface and that environmental factors e.g. turbulences (see Stommel 1949) will not effect the sinking rates significantly, it can be calculated that eggs will sink down to about 1000 to 1600 m. Hatching will then take place much shallower than assumed by Marr (1962) and other authors (Voronina 1974, Everson 1976).

If this is true the question raises, why krill eggs are so seldom found in plankton samples (e.g. see Hempel et al. 1979). From our point of view this could possibly be explained by a reduced catch efficiency of the employed nets.

To show the effect of plankton nets on krill eggs 1 l of seawater with 200 krill eggs was carefully poured through a 200 μ m sieve (Marschall and Hirche in press). This procedure - carried out four times - is equal to the concentration of a plankton sample after the catch. In two cases eggs were counted immediately after pouring. In the other cases eggs were preserved in 4% borax buffered formaldehyd and counted one year later. Results are given in Tab. 4.

Tab. 4 Decrease of egg number after pouring through a 200 μ m sieve.
Number of eggs at start of each experiment: 200.

	pouring		number of recovered eggs			
	time	sec	intact	deformed	total	% lost
fresh eggs	1	15	68	22	90	55
	2	13	84	39	123	39
preserved after pouring	3	15	75	35	110	45
	4	11	68	33	101	50

Egg number decreases in all experiments - due to pouring through a sieve - to about 50%.

From our results we feel that rare numbers of krill eggs in the former plankton samples could be explained by low catch efficiency of the employed nets and that other methods for determining the abundance of krill eggs, such as sediment traps, underwater photography or more indulgent nets have to be evaluated.

References

- Hempel I, Hempel G, Baker A de C (1979) Early life history stages of krill (Euphausia superba) in Bransfield Strait and Weddell Sea. *Meeresforsch* 27:267-281
- Everson I (1976) Antarctic krill: a reappraisal of its distribution. *Polar Record* 18, 112:15-23
- Marr JWS (1962) The natural history and geography of the Antarctic krill (Euphausia superba Dana). *Discovery Rep* 32:33-464
- Marschall HP (1983) Sinking speed, density and size of Euphausiid eggs. *Meeresforsch* 30:1-9
- Marschall HP, Hirche HJ (in press) Development of eggs and nauplii of Euphausia superba. *Polar Biol*
- Stommel H (1949) Trajectories of small bodies sinking slowly through convection cells. *J Mar Res* 8:24-29
- Voronina NM (1974) An attempt at a functional analysis of the distributional range of Euphausia superba. *Mar Biol* 24:347-352.

DEVELOPMENT OF EGGS OF ANTARCTIC KRILL EUPHAUSIA SUPERBA
IN RELATION TO PRESSURE

by

Robert Y. George and Jarl-Ove Strömberg

Abstract

This paper focuses upon the influence of increasing hydrostatic pressure on the development of krill eggs at 2°C. This experimental study on embryology of Euphausia superba was conducted at Palmer Station during 1982/83 austral summer. The gravid females were captured from Bransfield Strait aboard R/V Hero. The various embryological stages such as cleavage, blastula, gastrula and limb bud nauplius larva were defined and described. The duration for these various developmental stages at 1 Atm. was also established at +2°C and compared with the timing of this event at negative temperature. Krill egg development is inhibited at 4°C. The sinking rate of eggs and embryos was also measured at various pressure. The data suggests that pressure does not significantly influence the sinking rate. However, the cleaving eggs sink at faster rate (111-142 m/day) than the blastula and gastrula stages (91-96 m/day) and the advanced embryos at limb bud stage also have an increased velocity of sinking (121-132 m/day). There appears to be a wide variation of sinking rates of eggs within the same brood. Based on a simulated model of sinking rate, egg development was studied at increasing pressure. Pressure of 5-20 Atm. accelerates the rate of cleavage and therefore the 32-celled stage is attained within 5-8 hours and at 1 Atm. it took 13 hours to reach the same stage. Pressure seems to influence the duration of the development of krill eggs and embryos.

SUMMARY OF THE DISCUSSIONS OF THE SUB-GROUP ON
KRILL EARLY LIFE HISTORY

Chairman: Robert Y. George

Rapporteur: Jarl-Ove Strömberg

Present: C.J. Denys, R.Y. George, G. Hempel, I. Hempel,
H.-P. Marschall, A. Mujica and J.-O. Strömberg

Three phases of early life history of krill were defined as follows:

- I. Spawning to hatching,
- II. Non-feeding larval stages from nauplius I to metanauplius and
- III. Feeding larvae stages from calyptopes I to furcilia VI.

The focus of the discussion was to identify the major gaps in our knowledge on these three phases and to recommend possible avenue of research during the SIBEX and post-SIBEX period. The approach involved a critical look at our present state of knowledge on these three phases of early life history on the basis of two sets of data, namely (A) Field Data and (B) Laboratory Data. The field data included analyses of (a) Vertical Distribution, (b) Horizontal Distribution and (c) Temporal Distribution.

I. Spawning to Hatching

A. Field Data

- (a) Vertical distribution of krill eggs suggests minimum depth of occurrence at about 100-140 meters and maximum depth between 1000-2000 meters. This depth range for eggs and various stages of embryos is in agreement with available informations on sinking velocity of eggs in different levels of embryological development. Most of

the data on vertical distribution of eggs come from the studies of Hempel in the Scotia Sea and Antarctic peninsular area. The data suggests apparent depth stratification with earlier stages in shallower depth (100-400 m) and later stages in deeper depths (400-800 m).

- (b) Data on horizontal distribution of eggs and embryos suggests that they are primarily reported in the Atlantic Sector and peninsular areas and are rarely or seldom encountered in the vicinity of South Georgia. Although there have been reports of eggs and embryos in the Indian Ocean and Ross Sea, recent findings of the eggs come from the Atlantic Sector.
 - (c) Data on temporal distribution of eggs and embryos pointed out that the spawning event occurs during the Antarctic austral summer as early as late December and as late as mid-February.
- B. Laboratory data on egg development suggests that hatching occurs within 3 days at 2°C and 5-6 days at -1°C. Recent experimental data of George and Strömberg (in press) indicate that pressure appears to accelerate the cleavage of krill eggs and also egg development is inhibited at pressures exceeding 200 Atm. Low metabolism of krill eggs is recently reported by Ikeda (in press) and biochemical composition of the eggs with a low lipid level was reported recently by George (in press). However, our knowledge on energy budget for krill egg development and biochemical compositional change during embryogenesis remains still incomplete.

Recommended Studies

In situ capture of krill eggs and embryos from various depths should focus upon better sampling methods due to the extreme fragility and apparent rupture of the eggs in

conventional net trawls. The group felt the need for developing moored and drifting traps (like sediment traps) for in situ capture of krill eggs and embryos. Such traps should be deployed in January or early February in tune with the spawning event in areas adjacent to Elephant Island and near tip of Antarctic peninsular areas where schools of spawning gravid females occur.

II. Non-Feeding Larval Stages (nauplius I to metanauplius)

A. Field Data

- (a) Data on the vertical distribution of these early larval stages are very scarce. The few records nauplius I & II at depths between 1000 and 2000 meters indicate that after hatching these larvae still sink to deeper depths. Metanauplius is found between 500 and 1000 meters.
- (b) Data on geographic distribution around the Antarctic continent is very fragmentary since the few known records come from the peninsular area within the SIBEX study area.
- (c) The duration between hatching and metanauplius larval stage is approximately 21 days. Therefore, these non-feeding larvae are encountered in the field between late January and early February period.

B. Laboratory data on the behavior of nauplius I & II suggests that these larvae are pressure-adapted up to 250 Atm. (George in press). There is some evidence of uptake of dissolved organic substances such as amino acids (George, unpublished data).

Observations on lab-spawned larvae (Marschall and Hirche in press) point out that nauplii still sink in the water column and are extremely poor swimmers. The metanauplius larvae are good swimmers and begin to show the developmental ascent.

Recommended studies

There is need for studies on

- (1) the behavioral patterns of these larvae in simulated habitat pressure;
- (2) biochemical investigations on lipid density and compositional changes to explain the buoyancy modifications.
- (3) Morphometric and anatomical (including ultrastructural) studies on swimming appendages of metanauplius and
- (4) metamorphic moulting and growth studies and
- (5) studies on vision and sensory systems in relation to gravity fields and phototaxis.

III. Feeding Larval Stages (C1,C2,C3,F1,F2,F3,F4,F5 & F6)

A. Field data

- (a) The vertical distribution of these larvae is confined to the photic zone down to 200 meters. Recent investigations revealed extensive swarms of calytopis larvae at the surface. Diurnal migration trends of the calytopis larvae is poorly understood. Late furcilia stages exhibit more pronounced vertical diurnal migrations.
- (b) Mass production of calytopes at the surface in millions per 1000 m³, was recently encountered during the German investigations in the vicinity of the Scotian Arc/Scotia Sea. "Melville" studies by US investigators also reported on the calytopes swarms north of Elephant Island (ref. Wilmington Krill Symposium, Oct. 1982). When the C1-2

larvae occur in great abundance, they also occupy wide ranges. The C1 & C2 are also known in the vicinity of King George Island. These larvae were also reported from the Indian Ocean during the Discovery Investigations (Marr's data). However, the calyptopes do not occur near South Georgia, but most seen near the tip of Antarctic Peninsula.

(c) The calyptopes occur in the field mostly in February during the Antarctic austral summer and can possibly occur also in early March. The furcilia stages are poorly known and most likely occur in the late austral summer, the late stages extending into the early winter months.

B. Laboratory data on these feeding larval stages is practically lacking.

Recommended studies

The group felt that it is important to obtain data on

- (1) the growth of late furcilia stages in the winter and
- (2) the feeding strategy of these larvae in relation to temperature, photo-periodism, low hydrostatic pressure and food availability.
- (3) The group also felt the need for laboratory-oriented morphological (feeding and swimming patterns), physiological and biochemical studies on lab-spawned krill larvae.

In conclusion, the working group on the early life history of the Antarctic krill Euphausia superba emphasized the following three conceptual ideas for potential studies during the SIBEX and post-SIBEX period.

A. Investigations on the fate of the millions and millions of the spawned krill eggs, both in the shelf and oceanic regions. This is feasible by conducting "Krill Egg Trap" (KET) experiments by drifting and moored traps.

- B. Elucidation of the mechanisms behind the ascent of early non-feeding larval stages.
- C. Growth and feeding strategies of the late furcilia in the winter.

References

- George RY (in press) Ontogenetic adaptations in growth and metabolism of Euphausia superba in relation to pressure and temperature. J Crust Biol
- George RY, Strömberg JO (in press) Development of eggs of Antarctic krill Euphausia superba in relation to pressure. Polar Biol
- Ikeda T (in press) Sequences in metabolic rates and elemental composition (C,N,P) during the development of Euphausia superba and estimated food requirements during its life span. J Crust Biol
- Marschall HP, Hirche HJ (in press) Development of eggs and nauplii of Euphausia superba. Polar Biol

MOULTING AND MOULT PHYSIOLOGY IN KRILL

by

Fritz Buchholz

Growth in the arthropods is dependent on moulting. In contrast to insecta the last metamorphic moult in the crustacea is not the last one at all; moulting continues in basically identical cycles during the larger part of the life span. Important physiological and biochemical changes are observed during the course of a single moult cycle.

Moulting studies in krill follow two aims. Firstly to assess growth rates in order to gain data on production and to provide a basis for longevity calculations. Secondly to quantify the cyclical biochemical turnover involved in the moulting process, particularly with regard to the energy balance of the animal. Furthermore, in direct comparison to other crustaceans, the special adaptation of krill to the Antarctic environment is of interest.

An experimental approach to these aims calls for certain standard methods. To investigate moult frequencies and growth increments in individual animals, sophisticated maintenance experiments over prolonged periods and under controlled environmental conditions are required. These meet with two difficulties. Firstly, as a pelagic animal, krill lives in an environment without any kind of boundary. Accordingly, living in maintenance chambers is a highly unnatural situation. Secondly, being a phytoplankton feeder, it is not easy to supply the krill with sufficient food regularly.

In conjunction with aquaria experiments and length-frequency determinations, direct monitoring of moulting in the field is necessary. As krill appears in highly mobile swarms, and as

the Antarctic weather conditions impede continuous sampling, this is also a difficult task.

Furthermore, to assess the dynamics of various biochemical and physiological parameters during the moult cycle, a system is needed to subdivide it into distinct and easily distinguishable phases and stages. Using such a system, samples can be moult staged, frozen, and determined in the home laboratory.

An overview of the current state of progress in these three approaches (with the exception of metamorphic moulting) will be given in the following. A detailed review is currently being prepared. Mackintosh (1967), Clarke (1976), Murano et al. (1979), Ikeda and Dixon (1982a, b), and Poleck and Denys (1982) have published results of laboratory observations on moulting so far. The investigations of Morris and Keck, Ikeda et al., Segawa et al., and Buchholz are in preparation.

All authors kept krill singly under relatively simple conditions, specifically using 1-7 l closed-vessel containers, with the exception of Morris and Keck (in press) who used a through-flow system, a prototype of the one employed by Buchholz (in prep). Mackintosh (1967) and Clarke (1976) fed krill by changing the water contents of the experimental chambers regularly, or constantly [through-flow, Morris and Keck (in press) and Buchholz (in prep)]. All others added phytoplankton, either cultured for this purpose or taken from the field.

In all papers it is either obvious, judging from the present knowledge of the high filtering rate of krill, or it was stated by the authors, that the food supply was not optimal. Ikeda et al. (in prep) and Buchholz (in prep) included starvation experiments. The intermoult periods (IMP) registered ranged between 13 and 30 days. Morris and Keck (in press) and Ikeda and Dixon (1982a, b) noted a clear dependence on temperature (-1.0 - +8.0) in this respect, which could not be confirmed in a later experiment (Ikeda et al. in

prep) but was again supported by Poleck and Denys (1982). Whether IMP is directly proportional to body size in krill as is common in other crustaceans, is not clear (Murano et al. 1979, Ikeda and Dixon 1982a, b, Poleck and Denys 1982, Buchholz in prep). Under laboratory conditions moulting goes on regularly and without great variation, even when animals are starved (Ikeda and Dixon 1982a, b). The surprising fact is that all authors noted either no growth or body shrinkage, with positive growth as the exception. This is most certainly due to the maintenance situation and may particularly be caused by handling effects, insufficient size of the containers and deficiencies in food. When moulting rates of starved krill were directly compared to fed krill (Ikeda and Dixon 1982a, b) neither group grew, but the starved krill showed a substantial decrease in body length and weight which amounted to up to 56% over a period of seven months. It was argued that body shrinkage might be a strategy for overwintering, when the stock of phytoplankton is scarce or nil so that krill has to burn up body substance to fulfil its energy needs.

As maintenance effects seem to be a major cause of low-growth data so far, it is certainly necessary to develop more sophisticated aquaria facilities. Buchholz (in prep) 1979 developed a through-flow system that reduces handling on one part and furnishes a constant supply of natural phytoplankton on the other. This device was employed by Morris and Keck (in press), and positive growth of 8% per moult and a mean IMP of 14.3 days was encountered in 12 specimens. The second moults registered showed negative growth though. This system was improved, consisting of 54 submerged perspex-jars (1.1 l) with an inflow of fresh seawater to each container, and was used for three months at the Polish Arctowski-Station in 1982/83 (Buchholz in prep). A second constant-volume system was employed additionally. It consisted of 96 1 l jars, each having two outlets at the bottom, allowing water to be exchanged at regular intervals without touching the animals. The krill was fed in the latter case with phytoplankton

cultures, with the best results gained by employing the fresh-water plankter Chlorella spec. which can be found in large quantities in hypertrophied fresh-water lakes near Arctowski Station. Chlorella was fed to such an extent that the digestive tract of the krill constantly showed a dark green to black colour. The experimental temperature was 3 and 2°C and the light cycle 16 : 8 h light/dark. The general mortality of both systems was less than 6%/month. To further reduce handling, only the uropods and carapaces of exuviae were measured to determine the growth increments.

A detailed description of the experiments is being prepared, so only a short summary of the major results will be given here. 610 moults were registered and it was noted that moulting occurs rhythmically with low variation, with a mean for the first and second IMP of 15 days in the through-flow tanks and 17 days in the closed system.

The shorter interval is due to the higher temperature (3°C). The length of the moult interval could be altered experimentally by changing the amount of food given. Cutting the through-flow, which corresponded to starving the animals, resulted in a considerable increase of up to 100% of the IMP and also increased the individual variation substantially. Secondly the IMP was statistically significantly shortened by three days when the amount of Chlorella given was doubled in comparison to the amount fed initially.

The growth increment expressed in percent linear growth per moult stayed comparable throughout all experiments on fed animals. The mean of the first moults was always highest (3.5-5%).

The following growth increments decreased but stayed positive with only one exception. When the animals were starved the mean growth increment became negative. The values of the

individual animals showed a remarkable variation and ranged from 20% increase to -15% negative growth, with a wide spread of values between these extremes.

Interpreting the results, it can be noted that the length of the IMP decreases when more food is offered, and the opposite happens under starvation conditions. Accordingly, krill adjusts to the food situation by changing its frequency of moulting. This mechanism is also found in decapod crustaceans.

Considering the growth increments, the first moult always shows the greatest increase, and this possibly comes nearest to the situation in the field.

Thereafter, the effects of the still unfavourable maintenance conditions set in and growth decreases. Body shrinkage occurs, when the food source is eliminated completely. Apparently krill adjusts its growth very sensitively to the specific environmental situation by both altering its frequency of moulting as well as the increase in size. In contrast decapod crustaceans only change their sequence of moults while the growth increment at each ecdysis stays largely constant. This sensitive double reaction found in krill has certainly consequences for the design of maintenance experiments. It may well happen that after a certain period of adjustment krill adapts its growth perfectly to the experimental situation when moulting goes on regularly, but the moulting parameters become far different from those under natural conditions. Consequently, the described experiments were constructed in such a way that a large number of animals were studied over shorter periods rather than fewer animals observed over prolonged times. A larger set of data also helps to reduce the effects of individual variation by statistical means.

The published moulting data should be carefully evaluated, particularly in respect to determining the ranges of positive and negative growth and to the consequences of calculating longevity on the basis of maintenance experiments. Generally

it can be stated that the published data on positive growth seem to be low seen in the light of the data of Morris and Keck (in press) and those of the experiments described. These latter values fall well into the range of a theoretical growth curve which was constructed by Mauchline (1980) and from which growth of 0.133 mm/day can be extrapolated for krill of the same size class.

A phenomenon was noted in the experiments which was also described by Clarke (1976): although the krill was kept in isolated cylinders the animals tended to moult together. It could be verified by moult staging that the krill was not synchronized by physiological shock due to capture. Instead the initial state of moulting seen in the field population was reflected in the subsequent experimental moults.

The concept of simultaneous moulting can also help in field investigations. If swarms or part of swarms moult synchronously, a coincident temporal development of the moult cycles in individual animals should be seen. The moult staging method to be employed in such observations considers the rigidity of the exoskeleton and the formation of new bristles inside the present ones, to monitor the progress of individual krill towards the next ecdysis (Buchholz 1982). A good temporal correlation of the moult stages could be verified (Morris and Keck in press and Buchholz in prep). It is then possible to predict when an individual animal or, if synchrony occurs, an aggregation of krill will moult. As a matter of fact, a simultaneous development could be observed using the said method in 250 krill kept in a 700 l through-flow tank. In analysing field samples, clearly uneven, unimodal distribution of stages were seen, which also suggest synchronous moulting. The system will be used to investigate the overall moulting structure of swarms in more detail, and to gain data, employing the moult/time correlation, on moulting frequencies in the field. If times of mass moulting could be detected, direct measurements of growth should also be possible. Currently the

system is being used, in collaboration with D. Morris, to monitor the moulting activity of winter swarms off South Georgia.

Furthermore the biochemistry of the moult cycle is being analysed in our laboratory at present. The major aims are to gain a picture of the general chemical composition of the individual krill, and of how much its energy-needs are affected by the moulting processes. A study on the turnover of lipids is now being completed. Proteins, carbohydrates, the moulting hormone, and other parameters are currently under investigation. Special regard is being given to the composition of the cuticle. In this connection we studied the balance of fluorine during the moult cycle. Over 90% of the fluorine is lost with the exuvia. Inside 36 h after the moult, almost the full amount of fluorine has been reaccumulated in the exoskeleton. Accordingly, a very effective mechanism for uptake must exist. During the time of fluorine accumulation the feeding activity of the animals is reduced, so the major source of the fluorine must be the water and not plankton. The internal values stay low and do not change appreciably. Consequently the functional location of the compound is the cuticle. Currently we are investigating if fluorine is directly involved in the hardening process.

References

- Buchholz F (1982) Drach's moult staging system adapted for euphausiids. *Mar Biol* 66:301-305
- Buchholz (in prep) Growth of Euphausia superba in aquaria
- Clarke A (1976) Some observations on krill (Euphausia superba Dana) maintained alive in the laboratory. *Bull Br Antarct Surv* 43:111-118
- Ikeda T, Dixon P (1982a) Body shrinkage as a possible over-wintering mechanism of the Antarctic Krill, Euphausia superba Dana. *J Exp Mar Biol Ecol* 62:143-152
- Ikeda T, Dixon P (1982b) Observations on moulting in Antarctic Krill (Euphausia superba Dana). *Aust J Fr Freshwater Res* 33:71-76

- Ikeda T, Dixon P, Kirkwood J (in prep) Laboratory observations of moulting, growth and maturation of the Antarctic Krill Euphausia superba.
- Mackintosh NA (1967) Maintenance of living Euphausia superba and frequency of moults. *Nor Hvalfangs-Tid* 56:97-102
- Mauchline J (1980) The biology of mysids and euphausiids. *Adv Mar Biol* 18:681pp
- Morris DJ, Keck A (in press) Preliminary studies of the time course of the moult cycle of Euphausia superba in the laboratory. *Meeresforsch*
- Murano M, Segawa S, Kato M (1979) Moults and growth of the Antarctic krill in laboratory. *Trans Tokyo Univ Fish* 3:99-106
- Poleck TP, Denys CJ (1982) Effect of temperature on the moulting, growth and maturation of the Antarctic krill Euphausia superba (Crustacea: Euphausiacea) under laboratory conditions. *Mar Biol* 70:255-265
- Segawa S, Kato M, Murano M (in prep) Growth, moult and filtering rate of krill in laboratory conditions.

LABORATORY OBSERVATIONS OF MOULTING, GROWTH AND MATURATION
OF THE ANTARCTIC KRILL (EUPHAUSIA SUPERBA DANA)

by

Tom Ikeda, P. Dixon and John M. Kirkwood

Abstract

Observations of intermoult period, growth and maturation were made on krill maintained in the laboratory over a three year period. The mean intermoult period (IP) for each of 10 specimens (initial body length: 24.7-46.8 mm) kept at -0.5°C varied from 22.0 to 29.8 days (overall mean = 26.6 days). These measurements of IP are significantly longer than those obtained in some previous studies. Differences in experimental temperatures and body sizes of the specimens between studies are unlikely to be causes of these dissimilar results.

The pattern of changes in body lengths (BL) varied from one individual to the next. The greatest increase in BL over a series of 4-5 moults ranged from 0.024 to 0.070 mm/day, which is equivalent to 0.0020 to 0.0086/day in body weight, assuming exponential growth. This maximum growth rate is about half of the rate predicted from the growth scheme of Mauchline (1980) for wild krill. Comparison of growth data for other euphausiids suggests that Mauchline's scheme produces an anomalous growth rate.

The slower growth rate observed in the present study would extend the estimated life span of krill from 3-4 years, as calculated by Mauchline (1980), to 4-7 years. If krill undergo body shrinkage during the Antarctic winter the estimated life span would be even longer.

Examination of the external sexual characters of moults showed both progression and regression of maturity stage in association with changes in BL.

References

Mauchline J (1980) The biology of mysids and euphausiids. Adv
Mar Biol 18:681pp

Co-authors' addresses: P. Dixon
Australian Institute of Marine Sciences
P.M.B. No. 3
Townsville M.S.O.
Queensland 4810
Australia

J. Kirkwood
Australian Antarctic Division
Department of Science and Technology
Channel Highway
Kingston 7150 Tasmania
Australia

A SIMPLE KRILL GROWTH MODEL

by

Henning Astheimer, Hans Krause

and

Stanislaw Rakusa-Suszczewski

Abstract

Growth of the Antarctic krill, Euphausia superba, is not easily determined from catches nor from laboratory experiments. Therefore, in support of these methods, a phenomenological model was constructed which in its present state describes the growth of a single krill specimen under periodically limiting food conditions with summer seasons of variable lengths.

Published data of krill body length vs. age and of the annual cycle of primary production of algae in the Drake Passage were used to formulate equations and to calculate growth curves. At 1,000 days after hatching, the model predicts a body length of 62 mm, growth being delayed by 390 days compared with constant feeding conditions. Final length, weight and time delay were related to the amount of food supplied and compared with published population growth curves.

In general, modelled individual lengths exceeded those for population means in the wild, probably because of processes like mortality, actual food conditions, advection, catchability, etc. These processes can be incorporated in future model versions as soon as their dynamics and impact on krill growth will be understood and described in terms of mathematical expressions.

Co-author's address: H. Krause
Alfred-Wegener-Institut
für Polarforschung
Columbus-Center
2850 Bremerhaven
Fed. Rep. Germany

POTENTIAL RELATIONSHIPS BETWEEN PARTICULATE MATTER
AND NUTRITIONAL PROCESSES OF EUPHAUSIA SUPERBA.

A REVIEW OF THE RESULTS OBTAINED
DURING THE MD25/FIBEX CRUISE

by

Patrick Mayzaud

In the pelagic environment, the sequence of physiological phenomenon which govern biological productivity is now well established. Animal must locate their food and when possible ingest it. Once this has been done, the enzyme facilitate the assimilation of a portion, the residual being discarded as faeces. Of that assimilated, one portion is respired to provide energy for all life processes and another dissipated in the urine. The residual constitutes growth whether the end product be new tissue, reproductive products or stored energy.

During the FIBEX cruise in the Indian sector of the Antarctic ocean of the R.V. Marion-Dufresne (Fig. 1), our studies on the nutritional processes of Euphausia superba was aimed at a definition of the trophic environment, an evaluation of the feeding-digestion relationships and an estimation of the krill productivity.

Trophic environment of E. superba

The results clearly illustrate the difficulties involve in applying to the Antarctic ecosystem the concepts and methodologies adapted to northern waters. Indeed, any study of nutritional processes in natural planktonic communities relies on several assumptions:

- 1) the particulate matter collected is representative of the food supply,
- 2) there is a trophic link between the food sampled and the consumers and

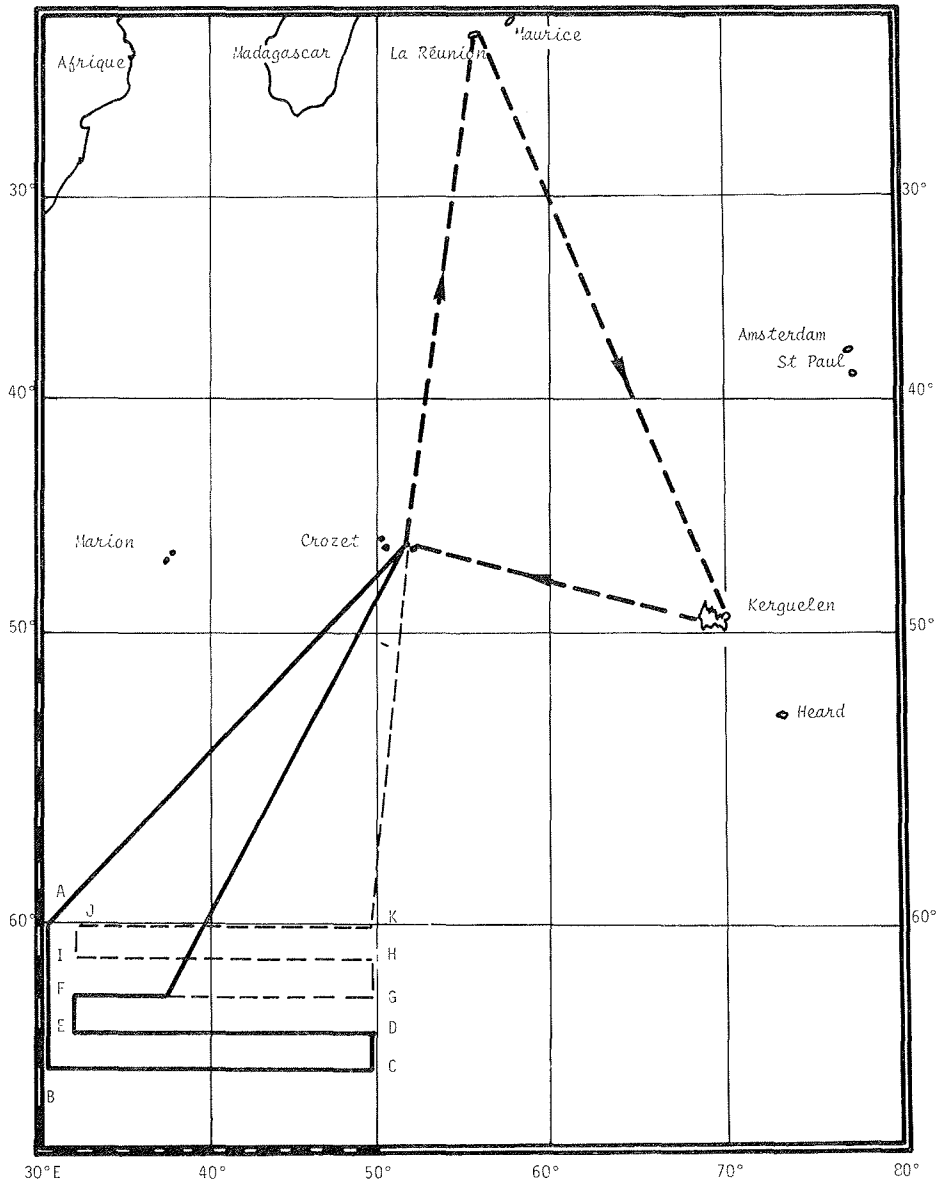

Fig. 1 Area surveyed during the FIBEX cruise of the R.V. Marion-Dufresne.
 — covered distance during FIBEX (Jan.-Mar. 1981)
 - - - transit
 planned route

3) our knowledge of the biology of the organisms is good enough to evaluate the impact of adaptative strategies on the general metabolism.

The low levels of chlorophyll and primary production (Tab. 1) confirmed the conclusions of Jacques et al. (1982) that during the summer we were dealing with a low primary productivity and low biomass system. The amount of total protein, carbohydrates and lipids observed were quite comparable with those of an oligotrophic sea such as the Ligurian Sea. Decreasing amounts of particulate matter were observed from north to south with different vertical distributions: stations located along the 63°S latitude showed higher concentrations, restricted to the surface layer, while stations along the 64°S presented subsurface low levels at 50 or 75 m depths. Except for station 1, the carbohydrates to protein ratio was generally low (0.2 to 0.7) suggesting that phytoplankton was in an early stage of growth.

Distribution and chemical composition of E. superba

Krill biomass was estimated by echo-integration over the entire sampling area. Four zones were defined and the krill density appears to increase from west to east (Fig. 2). The occurrence of E. superba between 38°E and 44°E was somewhat surprising since mostly Thysanoessa macrura was sampled in that area (A3).

Comparisons of size frequency distribution were carried out from samples collected either with a RMT8 net or a 2 mm mesh size, 2 m² aperture net. From the data reported by Gely (1983), it appears that the western populations were mostly constitute of juveniles and subadults (30 to 46 mm average length) while the eastern populations were composed of large subadults and adults (47 to 50 mm average length - Tab. 2).

Tab. 1 Integrated chlorophyll a and primary production over the first 75 m (from M. Panouze, unpubl. data)

Station no	Chlorophyll <u>a</u> mg.m ⁻²	Production mgC.m ⁻² .d ⁻¹
1	10.7	457
2	28.7	211
3	10.8	57
4	23.6	41
5	37.9	186
6	33.0	145
7	25.3	132
8	17.3	178
9	24.7	242
10	17.2	228
11	12.2	75
12	35.9	211
13	28.2	364
15	26.5	285
16	32.7	304
17	60.7	183
18	29.8	418
19	8.1	112
20	19.7	250
21	36.3	113
22	11.9	242
23	13.3	404

Tab. 2 Maturity stages of the populations sampled (% total) from Gely (1983).

Station	Juveniles	Subadultes	Adult males	Adult females	
				non-ovigerous	ovigerous
1	92	0	0	0	0
3	12	60	13	8	8
5	0	47	25	10	19
17	31	33	14	9	13
19	17	71	8	0	4
23	100	0	0	0	0
9	0	0	50	0	50
9A	0	31	20	2	47
10	0	40	36	0	24
13	0	0	46	0	54

A ₁	d = 2.4
A ₂	d = 3.0
A ₃	d = 8.3
A ₄	d = 11.6

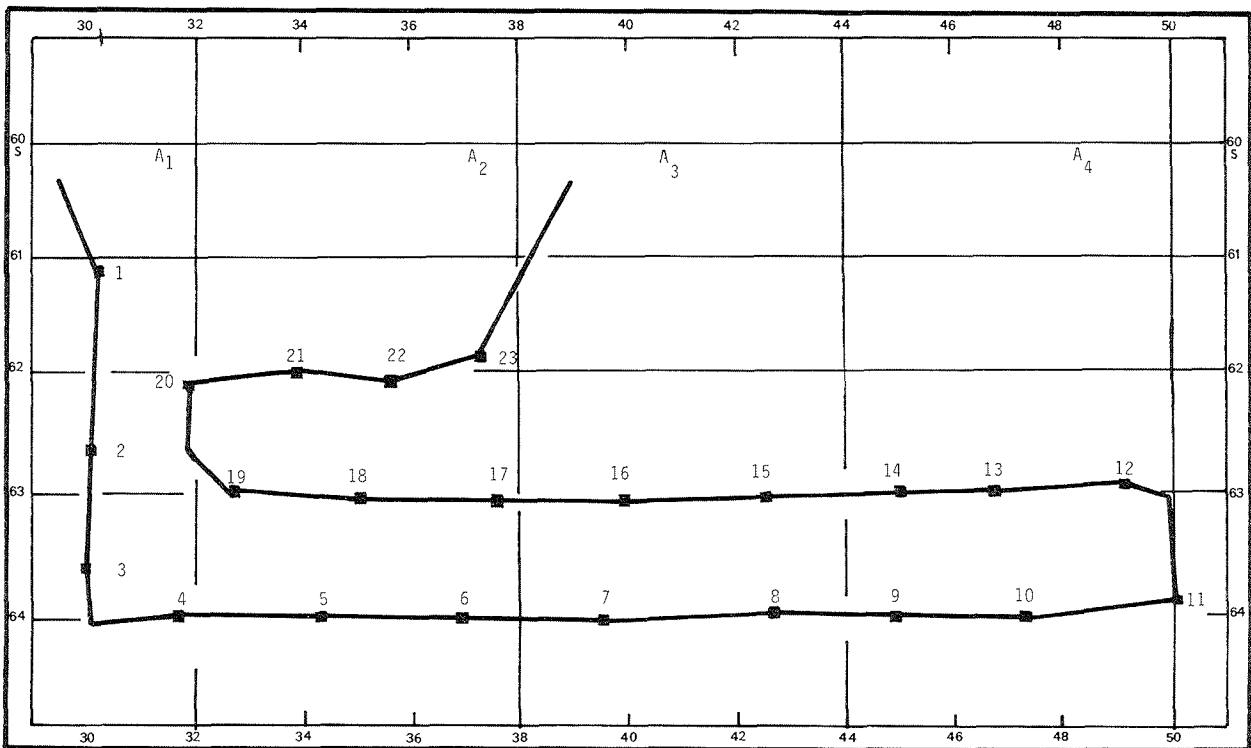

Fig. 2 Krill densities recorded by echosounder for the different areas surveyed. d in g/m². ■ station

The biochemical composition of the individuals collected at the same stations confirms this west-east separation. As shown in Tab. 3, western smaller animals seemed to display, on average, slightly higher lipid content than the eastern ones. The variability of the results prevented any statistical assurance for such relationship.

Tab. 3 Lipid and protein content of E. superba as % of the dry weight (from F. Lorda in prep)

Station	Protein % dry weight	Lipid % dry weight
2	45	16
3	58	15
5	43	10
5A	59	7
6	56	7
17	71	12
18	63	12
19	52	17
23	57	11
9	60	10
9A	50	8
10	57	15
11	57	6

Digestive enzymes activities

The exact nature of the diet of E. superba remains somewhat unknown. Phytoplankton is certainly an important component, but microzooplankton and small crustaceans may be used to supplement their diet. This omnivorous character is well reflected in the spectrum of digestive enzymes observed with strong carbohydrases (laminarinase) and protease (trypsin). That larger animals with lower lipid content displayed the higher enzyme activities was somewhat surprising but could be understood if we consider that larger adults had higher energy requirements to build up new lipid reserves. Changes in enzyme

activities as well as biochemical composition strongly suggest that we were dealing with two populations corresponded respectively, to the descending and ascending branches of these structures.

Estimation of krill production

Production of zooplankton is usually estimated via laboratory established energy budget. Time consuming, this method give little information on the in situ values of secondary production and none on the spatial and temporal changes. Introduced by Butler et al. (1969) and applied to field zooplankton by Le Borgne (1978), the method based on the estimation of nitrogen/phosphorus ratios of food, feeders and excretory products seemed a promising approach. Unfortunately, technical limitations related to the specific chemical characteristics of the Antarctic waters, prevented the use of this method for accurate productivity estimate. Nevertheless the measurements of ammonia and phosphorus excretion yielded some interesting data since nitrogen excretion rates were maximum for the eastern animals while phosphorus excretion did not vary over the area sampled (Gely 1983). Excretion rates were high for both compounds, mainly when considering the large animal size and the low environmental temperature.

Conclusions and prospects

Rather than trophic relationships, it seems that we have described populations with different metabolic strategies, likely related to the reproductive one. Why particulate matter is spatially distributed in a different way than the animals remains to be clarified, but suggests that the hydrographic conditions affected differently the geographic distribution of food and consumers, except if we consider the possibility that the phytoplankton collected was not truly representative of the food supply of the euphausiids.

Several questions are worth considering in the context of the Antarctic environment and of the krill biology. What is the food of E. superba? Phytoplankton is an important component of the diet, but it seems unlikely that the other constituents of the particulate matter larger than 20 μm (Meyer and El-Sayed 1983) are not ingested. Little is known on the factors affecting grazing rates, even though size and chemical composition of the food have been shown to be important for other grazers (Conover 1978, Poulet and Marsot 1980). E. superba is known to migrate horizontally, thus a time shift between the moment the animals are captured and the location of the food is possible. In this context, how should we define practically the actual food supply? More studies on the nutritional strategy of this species are needed, as well as new approaches to the description of prey-predators relationships.

Growth and to a minor extent reproduction are linked to food supply through assimilation and energy storage. When seasonal changes cannot be easily studied, one should rely on biometric data and proximate analyses of the populations. Nevertheless, at any time it is very difficult to discriminate between animals where anabolism dominates and animals where catabolism dominates. Indices of lipid or carbohydrate turn-over are necessary before we can define the metabolic state of the various populations. Probably measurements of the enzyme systems responsible of the energy transfers will yield valuable informations.

Even if the physical processes are the major ones to explain the distribution of the krill, the demographic success of these populations reveals a sophisticated adaptative strategy to cope with such an unstable environment. Adaptations are known to occur at different time scale (Mayzaud and Poulet 1978) and the search for functional relationships should consider them. How individuals and populations acclimate to short and medium term changes of food quality and quantity?

Are there critical growth stages which present difficulties to adapt to such changes? Here are some of the questions which should be considered in the near future.

The ultimate goal of biological oceanography is to understand the distribution and abundance of the organisms in the sea. This appears to be a problem of population dynamics and trophic interactions which is qualitatively known for some time. Specific quantitative informations are needed for natural populations and the input of biochemistry in that venture can be triple:

- 1) help to reconsider critically the meaning of the measurements classically made and see their relevance to the problems;
- 2) propose new approaches to quantify physiological processes responsible of the transformations of the organic matter and the energy;
- 3) bring new concepts leading to the insertion of the biological events in the physical environment.

References

- Butler EI, Corner EDS, Marshall SM (1969) On the nutrition and metabolism of zooplankton: Feeding efficiency of Calanus in terms of nitrogen and phosphorus. J Mar Biol Ass UK 49:977-1001
- Conover RJ (1978) Transformation of organic matter. In: Kinne O (ed) Marine Ecology. John Wiley and Sons, Chichester, vol IV, pp 221-499
- Gely C (1983) Contribution à l'étude du krill Euphausia superba. Essai d'évaluation de la production secondaire par l'intermédiaire des coefficients d'utilisation de la nourriture assimilée. Doct 3ème cycle, Université Pierre et Marie Curie, 201pp
- Jacques G, de Billy G, Panouse M (1982) Biomasse et production primaire dans les secteurs antarctiques et subantarctiques de l'océan indien. CNFRA 53:87-99
- Le Borgne R (1978) Evaluation de la production secondaire planctonique en milieu océanique par la méthode des rapports C/N/P. Oceanologica Acta 1:107-118

- Mayzaud P, Poulet SA (1978) The importance of the time factor in the response of zooplankton to varying concentrations of naturally occurring particulate matter. *Limnol Oceanogr* 23:1144-1154
- Meyer MA, El-Sayed SZ (1983) Grazing of *Euphausia superba* on natural phytoplankton populations. *Polar Biol* 1:193-197
- Poulet SA, Marsot P (1980) Chemosensory feeding and food gathering by omnivorous marine copepod. In: Kerfoot C (ed) *Evolution and Ecology of Zooplankton Communities*. University Press of New England, Hannover, New Hampshire and London, England, pp 198-218

DEVELOPMENT OF AN ENERGY BUDGET FOR EUPHAUSIA SUPERBA

by

Andrew Clarke and David J. Morris

Introduction

In the past years we have developed a preliminary energy budget for the Antarctic krill, Euphausia superba Dana (Clarke and Morris 1983). We decided at the outset that the frequently used energetic equation (Ricker 1968):

$$C = P + R + F + U$$

(where C = consumption, P = production, that is growth + gonads, R = respiration, F = faeces and U = energy lost as urine, all in energetic units) was inappropriate for a pelagic crustacean which must expend significant amounts of energy merely staying in the water column. In particular, we felt that it is necessary to view metabolic rate (measured by oxygen consumption) as composed of several distinct but interlinked components, rather than as a single entity. We therefore decided to base our approach on that used for other (benthic) marine invertebrate filter feeders, whilst adding a component for swimming activity.

The major feature of this approach has been the partitioning of respiration into separate physiological processes. This division is discussed more fully in Clarke (1983) and Clarke and Morris (1983), but in outline respiration is taken to consist of the following components:

Basal metabolism: this is essentially the cost of staying alive, separate from any costs of activity or feeding. It is the sum of basal protein, lipid and nucleic acid turnover, ion pump activity, and basal circulation and nervous activity.

Metabolic cost of feeding: this includes the cost of filtration activity as well as the synthesis of digestive proteins and the transport of molecules across membranes (analogous to the specific dynamic action of fish).

Metabolic cost of swimming: this is the cost of moving through the water. In the sense that krill must swim continuously to prevent themselves from sinking, this may be regarded as a component of basal metabolism; we have, however, distinguished this as separate from true basal metabolism.

Two things are immediately clear. Firstly, that the costs of swimming and feeding are intimately linked (where for example should we place the energetic cost of vertical migration, swarming or complex search behaviour?), and secondly, that it will be impossible to make a direct measurement of basal metabolism as defined here. Dividing total respiration in this way does, however, indicate that unless measurements of the oxygen consumption of krill control for swimming or filtration activity, they tell us only little about the energetics of krill.

Making the (unlikely) assumption that values available in the literature for the oxygen consumption of krill at -1°C approximate true basal metabolism, and that the relative proportion of total respiration to growth may be estimated from published data for Euphausia pacifica (Lasker 1966), we have constructed a preliminary energy budget for Antarctic

krill (Tab. 1). Growth was estimated from the data in Mauchline (1980), and reproductive output taken as estimated by Clarke (1980). Note that the literature values for oxygen consumption are liable to be overestimates of basal metabolism, and hence the relative importance of respiration in the total budget may be similarly overestimated. This preliminary energy budget implies a daily food intake of $\sim 5\%$ body weight per day in male krill.

An improved model

Clearly basal metabolism (as defined above) cannot be measured directly. It can, however, be estimated indirectly as 'standard metabolism' from the relationship between swimming speed and oxygen consumption, QO_2 (Fig. 1). This approach is frequently used in studies of fish physiology, and has been applied to the euphausiid Thysanoessa spinifera (Torres et al. 1982). We feel that it is very important that this relationship is determined for a range of sizes of krill. Such an experiment would provide data for:

- i. The relationship between basal oxygen consumption and fresh weight (W), which is liable to be of the form

$$QO_2 = aW^b$$

with b probably between 0.7 and 0.9 for adult feeding stages. Note that basal metabolism estimated by such extrapolation will include the respiratory cost of any growth in progress at the time of the experiment. The QO_2 /weight relationship will therefore be different in summer and winter, and a true estimate of basal metabolism will likely only be obtainable in winter (when growth is minimal).

- ii. The cost of swimming, which is itself likely to be a function of krill size.

Tab. 1 An estimated energy budget for adult male and female Euphausia superba during the summer at South Georgia (from Clarke and Morris 1983).

	Total energy intake in 190 days (kJ)	
	male	female
Basal metabolic rate	(7.637)	(8.742)
Metabolic cost of activity (including swarming and vertical migration)	unknown	unknown
Metabolic cost of feeding	unknown	unknown
Somatic growth	6.754	6.754
Moults	0.837	0.837
Testis	unknown	-
Ovary	-	6.390
	Total	Total
	15.228 kJ	22.723 kJ
Assuming total respiratory losses (basal + swimming + feeding) are 80% of assimilated energy in males, total becomes	37.955 kJ	

If mean weight of a male krill in summer is taken to be 1.08 g (= 3.94 kJ), then daily energy intake is $0.0506 \text{ J J}^{-1}\text{d}^{-1}$ (= 5.1% body weight per day)

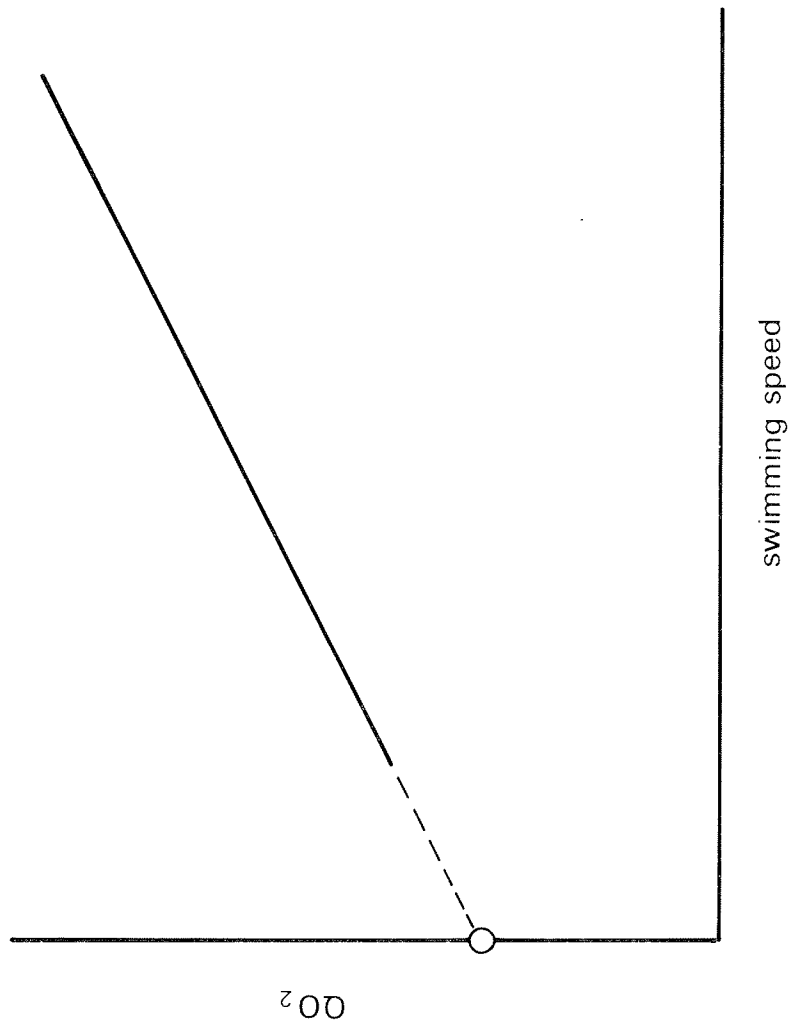

Fig. 1 Idealised representation of the relationship between swimming speed and oxygen consumption (QO_2) in krill. Basal metabolic rate is estimated by the standard rate of oxygen consumption (\circ), which is the oxygen consumption predicted for zero swimming speed by extrapolation (- - - -) of the experimental data (———) to the y axis.

Since feeding activity is superimposed on swimming, a small increment will need to be added to the model to account for the metabolic cost of feeding activity (Fig. 2). At the moment we have little idea whether this increment will prove to be large or small, and we realise that complex feeding behaviour (for example under sea-ice) will be difficult to interpret energetically. It is unlikely that experimental measurements will be as clear as the above model, and we will probably have to make do (at least initially) with a single increment for oxygen consumption as a function of feeding time and feeding method. However, until we know at least approximately the costs of swimming and feeding, these cannot be ignored just because they are difficult to measure.

The energetic cost of growth is often ignored in energy budgets (see Parry 1978, Clarke and Morris 1983), but is likely to be important. Basically, it is necessary to correct estimates of the energy content of new tissue for the fact that synthesis is not 100% efficient. It costs a krill more than 1 kJ to produce 1 kJ of new tissue; in other words it is not sufficient to quantify the energy diverted to growth merely as the calorific value of that tissue as determined by bomb calorimetry or as calculated from chemical composition data. Current estimates suggest that tissue synthesis is about 60-70% efficient, and a suitable correction factor will be built into the model. (Note that the respiratory cost of synthesis will be measured as a component of basal or standard metabolic rate, if this is measured in summer).

The cost of reproduction is also difficult to estimate, but as a first approximation it will be assumed that it is valid to use the energy content of new tissue (corrected, like growth, for the efficiency of synthesis). In doing so, the model must take into account the results of Makarov, Ross, Quetin and Denys on multiple ovary maturation. This will be difficult to quantify since the female krill are feeding and spawning eggs

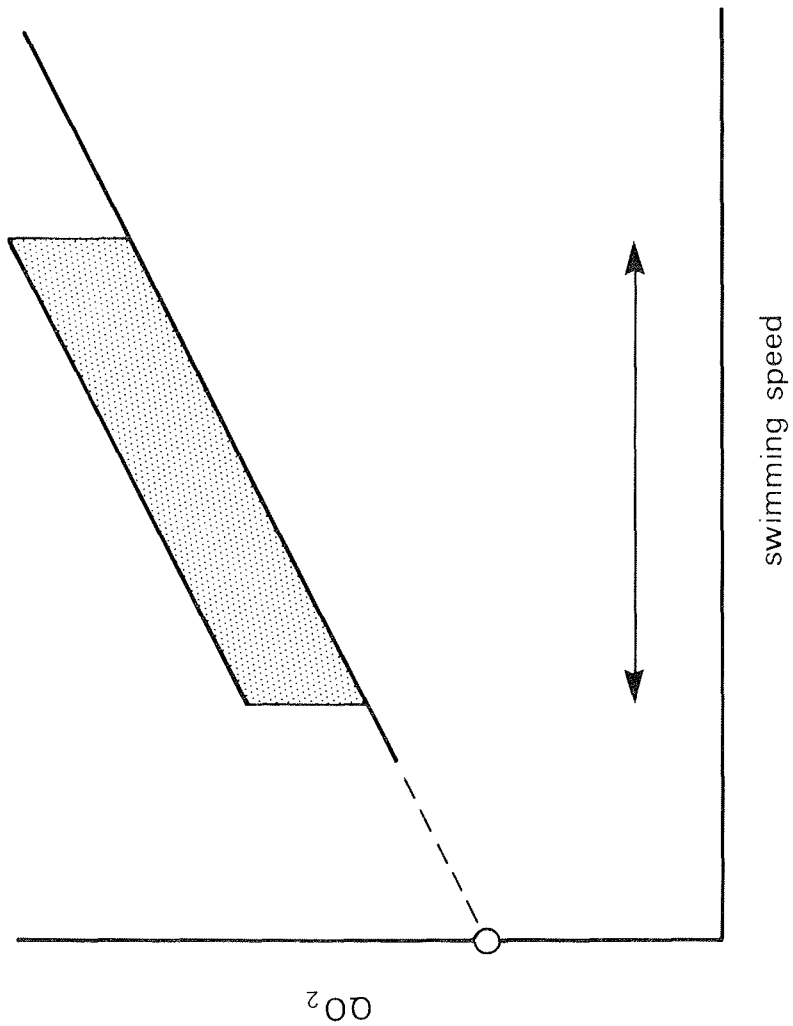

Fig. 2 Idealised representation of the relationship between swimming speed and oxygen consumption (QO_2) in krill, showing the increment due to feeding activity (grey area). The horizontal arrow shows the range of swimming speeds over which filtration activity is possible.

at the same time, whilst maintaining a fairly large ovary. At the moment we do not know how to estimate the cost of sperm production in males.

Compared with the errors in most of the above estimates, corrections for the effects of seasonal variations in temperature will be small, and in the first analysis they will be ignored. We do, however, recognise that some physiological processes in krill appear to be very sensitive to temperature (for example moulting rate), and that some temperature correction may eventually be necessary.

We propose to use this second-generation model as a basis for a program in PASCAL. The program will be structured so that changes in the accepted value of any given parameter (as a result of experimental work) can easily be accommodated, and the overall energetic consequences rapidly assessed.

We are fully aware that our approach has a number of difficulties. For one, it suggests that physiological measurements need to be made with a good degree of control for variables such as swimming speed and filtration activity. Whilst we appreciate that this makes krill physiology more difficult than dropping a freshly-trawled krill into a beaker of seawater, we do feel that it does make the eventual results more meaningful, both ecologically and physiologically. The effects of experimental design have been considered in a companion document by Morris (this volume); these and the factors discussed above have greatly influenced the construction of our experimental apparatus.

A final aspect of our approach to krill energetics is the need for substantial inputs from field observations in order to interpret physiological results in any meaningful way. For example, we need to know for what lengths of time krill feed, at what speeds they swim, and considerably more about swarming

behaviour. Perhaps this just serves to emphasize that E. superba is a social and active swimming organism, and needs to be viewed as such.

References

- Clarke A (1980) The biochemical composition of krill, Euphausia superba Dana, from South Georgia. *J Exp Mar Biol Ecol* 43:221-236
- Clarke A (1983) Life in cold water: the physiological ecology of polar marine ectotherms. *Oceanogr Mar Biol Ann Rev* 21:341-453
- Clarke A, Morris DJ (1983) Towards an energy budget for krill: the physiology and biochemistry of Euphausia superba Dana. *Polar Biol* 2:69-86
- Lasker R (1966) Feeding, growth and carbon utilization of a euphausiid crustacean. *J Fish Res Bd Can* 23:1291-1317
- Mauchline J (1980) The biology of mysids and euphausiids. *Adv Mar Biol* 18:1-681
- Morris DJ (1983) Experimental investigations of the ecological physiology of Euphausia superba. (This volume)
- Parry GD (1978) Effects of growth and temperature acclimation on metabolic rate in the limpet, Cellana tramoserica (Gastropoda: Patellidae). *J Anim Ecol* 47:351-368
- Ricker WE (ed) (1968) Methods for assessment of fish production in fresh waters. IBP Handbook No 3. Blackwell, Oxford, 313 pp
- Torres JJ, Childress JJ, Quetin LB (1982) A pressure vessel for the simultaneous determination of oxygen consumption and swimming speed. *Deep Sea Res* 29:631-639

EXPERIMENTAL INVESTIGATIONS OF THE ECOLOGICAL
PHYSIOLOGY OF EUPHAUSIA SUPERBA

by

David J. Morris

The constraints on experimental time and equipment involved in shipboard studies of the physiology of krill have limited the scope of investigations, and have generally necessitated short term experiments utilising krill immediately post-capture. The application to krill of experimental techniques derived from studies of other marine invertebrates (for example copepods) has imposed other limitations. Recently the aquarium facilities at South Georgia have been used to overcome some of the limitations of shipboard studies, and to investigate aspects of the physiology of krill over periods of weeks rather than days. This paper outlines the results of those investigations. Data will be presented more completely elsewhere.

Filtration rate

This was a preliminary study, investigating both filtration rate, and the reaction of krill to laboratory experiments. Initial experiments using constant volume vessels and measurement of the decrease in the number of particles (using a Coulter Counter), provided filtration estimates in accord with published data (obtained by estimating changes in chlorophyll concentration). Time course experiments, however, revealed that filtration rates during the first 15-30 minutes of the experiment were high, and then declined. This was a consequence of both an actual reduction in filtration activity, and an averaging effect resulting from the use of inappropriate time intervals. Subsequent investigations used throughflow vessels in an attempt to overcome the problems of refiltration. These techniques confirmed the limitations of the

constant volume experiments, which underestimated filtration rates whether measured as a function of chlorophyll or total particle depletion.

Further throughflow experiments, examining the particle size selection mechanism of *Euphausia superba*, also indicated that the methods used for the initial throughflow experiments were still underestimating filtration rate. This was because the techniques involved assumptions similar to those in measuring changes in chlorophyll concentrations in constant volume experiments, namely krill filter all particles with a uniform and high retention efficiency. Particle size analyses of krill filtration revealed a marked change in retention efficiency, above and below particles in the range 15-25 μm . If it is assumed that the maximum observed retention efficiency approximates 100%, then this increases the estimated filtration rate by a factor of at least 10. Backcalculation of filtration rates to be expected from physiological, energetic and behavioural data confirm these high filtration rates (Morris in press). The concept of filtration rate as a measure of food intake is therefore less useful than might be inferred from observations on other marine filter feeders. It is suggested that filtration rate, determined from particle size analyses, is used as an estimate of the work done (i.e. water filtered) to obtain food. Estimates of actual food (or carbon) intake should be made from direct measurements of carbon, chlorophyll or summed particle depletion in throughflow experiments.

The relationship between the amount of work done (water filtered) and the amount of food ingested, is dependant upon the actual filtration mechanism of krill. There have been several suggestions as to possible filtration mechanisms (Hamner in press, Kils pers. comm., McClatchie and Boyd 1983, Morris in press), falling roughly into two basic categories. These are a mechanical model of filtration (e.g. a sieve) and a model utilising the fluid dynamics of the filter basket in which the majority of the water flow is over not through the

setae. Recent scanning electron microscope work (Kils pers. comm., McClatchie and Boyd 1982, Morris unpublished observations) has shown a very complex structure for the filter basket, with microsetules on the setules forming a potential sieve of mesh $\leq 1 \mu\text{m}$. Experimental data show that krill can filter particles down to 1-2 μm in diameter, whatever the mechanism involved. It is likely that the filtration mechanism of krill is very flexible and that the two types of mechanism proposed are not mutually exclusive. This is possibly reflected in the wide range of feeding strategies employed by krill (on very small particles, such as bacteria or picoplankton ?, or copepods). Long term structural changes in the filtration mechanism of krill may also occur during growth, possibly as a strategy to cope with changes in food availability during winter.

The results of these studies on filtration rate led to an overall reappraisal of the requirements for experimental apparatus and design in studies of krill metabolism. It is felt that steady state, throughflow, experiments are preferable to non-steady state systems, as environmental parameters such as oxygen tension, ammonia and particle concentration do not change markedly during the experiment. In addition, the active pelagic mode of existence of krill indicates that confinement to relatively small static chambers is behaviourally inappropriate. As krill can be considered as crustacean equivalents of pelagic fish, it is likely that experimental techniques applicable to animals such as fish are more appropriate. This approach, however, has several disadvantages, particularly from a logistic viewpoint. Whilst krill may be behaviourally equivalent to fish, the corresponding changes in measured parameters due to metabolic activity are much reduced, resulting in undetectable differences between inflowing and outflowing seawater if relatively high throughflow rates are utilised. This is less of a limitation in the measurement of filtration rate, which is itself relatively high, but of great importance in measurements of oxygen consumption or ammonia excretion. The duality of a requirement

for both high and low flows (for filtration and respiration respectively) can now be considered, as it is felt that the use of throughflow systems in the study of krill metabolism are sufficiently well understood.

Before proposing an experimental protocol for eco-physiological studies of krill metabolism it is necessary to outline some of the effects on krill observed in throughflow systems.

The steady state

The use of throughflow experiments generally requires the assumption that prior to measurement the system is in a steady state, and that mixing inside the chamber is perfect and instantaneous (these conditions can be approximated with appropriate stirring and suitable chamber design). Variations in the flow rate, inflowing concentration and consumption rate of the animal all affect the equilibrium state. The equilibrium process which returns the system to a steady state after such variation is a function of the turnover time of the experimental chamber (chamber volume/(flow rate + consumption rate)). The duration of fluctuations in the supposedly steady state can therefore be minimised by controlling variations in the inflow concentration, utilising a high flow rate and minimising the volume of the chamber. The above must, however, be subject to constraints imposed by the behaviour of the krill and the relationship between the relative changes in the parameters measured.

System perturbation

Experiments have shown that artificial perturbation of a nominally steady state system (for example by altering the flow or the inflowing concentration) can provide estimates of consumption rates that are not based upon the assumptions required for a steady state system. This technique follows the equilibration process and estimates the metabolic parameter under study as a component of the turnover time. It provides a

useful adjunct to steady state determinations as the validity of the assumptions required can be tested. In addition, if logistic constraints prevent the elaborate control of parameters required for steady state experiments, system perturbation could be used as an alternative to determine physiological parameters such as filtration rate or respiration.

Flow rate

Except at very low flow rates, where environmental effects such as a fall in oxygen tension may occur, filtration rate is dependant of flow rate, except where particle concentrations are also low. System perturbation experiments reveal that during the equilibration process (when the flow has been altered from high to low) filtration rate remains high. This indicates that filtration rate is limited by particle concentration rather than flow rate. Equilibration occurs very rapidly in filtration experiments, so it is unlikely that a fall in oxygen tension or a rise in ammonia, resulting from the metabolism of the krill, are factors despite the low flow rate.

Current speed

The experiments on flow rate were primarily designed to investigate effects on filtration behaviour. Thus maximum flow rates utilised were determined by the requirement to measure differences in particle concentration. The requirement to simulate an "infinite" environment for the krill means that current speeds of the order of reported swimming speeds are needed. The above data on flow rate were obtained using flows up to 80 l/h for vessels ranging in volume from 0.145 to 23 l. The maximum nominal current speed (assuming laminar flow in the vessels) was approximately 0.3 cm/s. This occurred in the smallest vessel, and krill were observed to swim normally against the current, maintaining position within the vessel.

Reputed krill swimming speeds are in the range of 6 to 30 cm/s or greater. Thus flow rates required to simulate swimming speeds would not allow the measurement of filtration rate.

For a 2 l cylindrical vessel (diameter 10 cm, length 25 cm) a nominal current speed of 6 cm/s requires a flow rate of approximately 1,700 l/h. At such flow rates a 5% decrease in particle concentration requires a filtration rate of approximately 90 l/h. At the maximum reported filtration rate of krill (60 l/h), such a flow rate would result in a decrease in particle concentration of 4%. If the current speed is 30 cm/s (flow rate = 8,500 l/h), the required filtration rate rises to 450 l/h and the decrease in particle concentration falls to < 1%.

Chamber volume

The effects of chamber volume (for cylindrical vessels) have also been investigated as the turnover rate for equilibration can be increased by utilising low volume vessels. For individual krill, chamber volumes as low as 145 ml (adolescents) and 250 ml (adults) do not appear to affect filtration, provided the animal has a current to swim against. Krill have been kept in such conditions for > 2 weeks, generally maintaining position swimming into the current and filtering normally. On several occasions krill moulted successfully in the chambers. Individuals in larger vessels (up to 5 l) showed minimal orientation to inflowing water (probably as a result of reduced current speeds and non-laminar flows) but otherwise appeared to behave and feed as in smaller volumes.

Studies of large numbers of krill (at swarm densities of approximately 1, 5, 10 and 30 thousand per cubic meter) have been conducted using chamber volumes of approximately 5-25 l. Over this range there were no detectable effects of chamber volume on krill filtration. That is, filtration rates per animal were the same (for similar densities) whatever the chamber volume used.

Density of krill

The most marked effect of increasing density is a reduction in the filtration rate per animal. This has also been observed for lower numbers of animals in smaller chambers (Morris, Ward and Clarke 1983). Within certain limits, there is a trend for total filtration rate to reach a steady low level, at which further increases in krill density have no effect. This is interpreted as a limitation of food input (as a consequence of the relatively low flows used) resulting in a decrease in either the level or duration of filtration activity. Some experiments, however, indicated that the decrease in filtration may also be due, at least in part, to a behavioural response to the presence of other krill. The extrapolation of laboratory feeding studies to swarm conditions requires the resolution of the experimental and behavioural components of the observed reduction in filtration with increasing density.

Oxygen tension

Constant volume experiments measuring the respiration rate of krill result in a decrease in oxygen tension and an increase in the concentration of metabolites, primarily ammonia. Thus respiration rate is measured under conditions of changing experimental stress. The use of throughflow systems overcomes these problems and, in addition, allows repeated measurement of respiration rate over long periods of time. Preliminary studies of the respiration of krill using this technique have revealed an elevation in respiration rate by a factor of six as a direct result of introduction to the respirometer. A similar increase has also been observed immediately prior to an animal moulting.

The experimental limitation on throughflow respiration experiments is the requirement to measure oxygen differences in the inflowing and outflowing water. This necessitates the use of very low flow rates, which have effects upon the

swimming and feeding behaviour. Very low flow rates also increase the turnover time, reducing the sensitivity of the technique to short term changes in respiration rate.

Experiments to determine the effects of reduced levels of environmental oxygen tension have been performed, using inflowing water with the oxygen tension reduced artificially by nitrogen. These experiments revealed that decreased oxygen tension has a minimal effect on filtration rate above oxygen tension levels of 40-50 mm Hg. Below this, filtration decreases markedly and behavioural changes occur. This would suggest that the observed sensitivity of krill to decreased oxygen tension found in constant volume experiments (Kils 1979) may not be an effect of oxygen tension (whether it reflects a sensitivity to increasing concentrations of ammonia is as yet unknown). This is further supported by recent data on the oxygen affinity of krill haemocyanin which suggests a greater tolerance to decreased oxygen tension than indicated by Kils.

Given the logistic constraints of shipboard operations and the complex behaviour of krill, it is likely that adequate experimental measurements of eco-physiological parameters will require the use of sophisticated land based facilities. These will have to provide maintenance conditions that allow a simulation of the natural environment with particular emphasis on adequate supplies of food. Whether suitable food is provided as natural or cultured algae, artificial diet or smaller zooplankton will depend upon the results of the feeding studies currently being undertaken in several countries. Whatever the source, a controlled nutritional input is a vital requirement for land based studies. In addition, experimental facilities should allow repeated and long term measurements of physiological parameters in conjunction with experiments determining growth and behaviour. Such integrated studies should provide information which can then be extrapolated to natural conditions and tested by shipboard experiments.

An experimental design for eco-physiological studies of krill metabolism

From the above summaries of experimental determinations of the effects of laboratory studies on krill it has emerged that an ideal experimental apparatus would provide the following:

High current speeds, high turnover rates, low flow rates, and controlled inflowing concentrations. In addition continuous measurements of oxygen consumption, filtration rate, food intake and excretion rate should, if possible be made.

The contradictory requirements of a low flow rate and a high turnover rate can be overcome by the intermittent use of system perturbation experiments. The requirements for low flows and high current speeds can be met by recirculating the water through an open-flow respirometer. The high flows needed to provide sufficient food for normal filtration could be reduced by the use of controlled dosing of food to the inflowing water. Any reduction in flow, however, must be matched by a reduction in volume (to keep turnover times low). Further experimentation is required to determine the most suitable shape for the apparatus, but it seems likely that either a circular tank, or a cylindrical experimental chamber in a recirculating circuit, will be the most appropriate. The latter has been used with considerable success by Kils for swimming speed determinations and a version of the former will be tested on the forthcoming Winter Cruise of the John Biscoe.

References

- Hamner W (in press) In situ and laboratory studies on behaviour of E. superba in swarms and predator impact. J Crust Biol
- Kils U (1979) Performance of Antarctic krill Euphausia superba, at different levels of oxygen saturation. Meeresforsch 27:35-48

- McClatchie S, Boyd CM (1983) A morphological study of sieve efficiencies and mandibular surfaces in the Antarctic krill, Euphausia superba. Can J Fish Aquat Sci 40:955-967
- Morris DJ (in press) Filtration rates of Euphausia superba Dana: Under or over estimates? J Crust Biol
- Morris DJ, Ward P, Clarke A (1983) Some aspects of feeding in the Antarctic krill, Euphausia superba. Polar Biol 1:21-26

BIOCHEMISTRY OF EUPHAUSIA SUPERBA

by

Andrew Clarke

To date most of biochemical studies of Antarctic krill, Euphausia superba Dana, have concentrated either on proximate composition (Raymont et al. 1971, Clarke 1980) or the lipid fraction (Clarke 1983a), although there have been several investigations of enzyme function.

Lipid content data are now available in the literature for krill sampled on dates ranging from spring through to autumn. Unfortunately, in very few cases have the samples been separated according to sex or age before analysis. This makes the data rather difficult to interpret biologically. For example, the lipid content of adult female krill increases as the ovary matures. This may explain the increase in krill total lipid through the summer reported by several workers, but unless males, females and immatures are separated before analysis, it is not possible to say whether males are also increasing in lipid content. Evidence from South Georgia suggests that there may be some increase in male lipid during the summer, and the immatures tend to be richer in lipid than males. Current knowledge of krill lipid biochemistry has been summarised by Clarke (1980, 1983a, b).

The major requirement to complete the basic seasonal picture of krill biochemistry is for winter samples. In particular we need to determine whether an overwintering lipid store is synthesised at any stage of the life-cycle, and if so, what type of lipid is synthesised.

This information would give valuable clues to whether or not krill feed during the winter months. We are collecting a series of samples of krill throughout the late summer, autumn and winter from the Antarctic Peninsula and South Georgia

areas. These will be analysed for lipid content, lipid class composition and fatty acid composition. In addition, samples of krill will be taken in winter from around South Georgia for proximate chemical analysis, and an extensive sample over a wide size range will be taken to examine the relationships between total length, fresh weight, dry weight and ash weight. It is likely that if krill are undergoing the extensive tissue utilisation proposed by Ikeda and Dixon (1982), then these relationships will be different from those previously reported in the literature for krill sampled in summer.

So far physiological work in vivo or in vitro on lipid synthesis has been limited. The results from a preliminary study (Morris et al. 1983) gave a sensible biological picture, but were very much lower than values reported elsewhere for euphausiids. Lipid synthesis activity in the hepatopancreas was found to be more variable but with a greater median value in krill taken from the surface at night compared with krill sampled from 100 and 400 m. In future field seasons we propose to try alternative methods for following synthesis and utilisation of lipid. In particular, we will be feeding krill radio-labelled algae and bacteria and attempting to monitor specifically the transfer of food lipid to the krill hepatopancreas.

Recommendations

Lipids have been extracted from marine invertebrates (including krill) by a variety of methods, not all of which extract the total lipid. In addition, specimens are frequently dried before analysis. Based on experiences with extracting lipid from a wide range of marine invertebrates, it is recommended that in future studies of krill biochemistry the following procedures are used.

- i. Specimens are analysed fresh where possible, and stored deep frozen where this is not possible. Freezing should be rapid, and krill should be stored at -20°C or below.

- ii. Krill should be neither dried nor lyophilised before analysis, since both procedures affect the lipid composition. If it is necessary to express lipid as a function of dry weight, then a separate sample should be dried to determine water content.
- iii. Lipid should be extracted by homogenisation in methanol-chloroform (Bligh and Dyer 1959). Single solvent extractions (for example Soxhlet extraction with diethyl ether) should be avoided.
- iv. Total lipid should be determined either colorimetrically (using a suitable standard), or gravimetrically as long as solvents are removed at a fairly low temperature and under nitrogen. Useful colorimetric assays are either digestion in concentrated sulphuric acid at 180°C for 30 mins (optical density at 375 nm for a 1 cm path length is linear up to 1.5, equivalent to about 120 microgram triolein standard), or the sulpho-phospho-vanillin reaction (Barnes and Blackstock 1973).

References

- Barnes H, Blackstock J (1973) Estimation of lipids in marine animals and tissues: detailed investigation of the sulphophosphovanillin method for 'total' lipids. *J Exp Mar Biol Ecol* 12:103-118
- Bligh EG, Dyer WJ (1959) A rapid method of total lipid extraction and purification. *Can J Biochem Physiol* 37:911-917
- Clarke A (1980) The biochemical composition of krill, Euphausia superba Dana, from South Georgia. *J Exp Mar Biol Ecol* 43:221-236
- Clarke A (1983a) Lipid content and composition of Antarctic krill Euphausia superba Dana. *J Crust Biol*
- Clarke A (1983b) Life in cold water: the physiological ecology of polar marine ectotherms. *Oceanogr Mar Biol Ann Rev* 21:341-453
- Ikeda T, Dixon P (1982) Body shrinkage as a possible over-wintering mechanism of the Antarctic krill, Euphausia superba Dana. *J Exp Mar Biol Ecol* 62:143-151

- Morris DJ, Ward P, Clarke A (1983) Some aspects of feeding in the Antarctic krill, Euphausia superba. Polar Biol 2:21-26
- Raymont JEG, Srinivasagam RT, Raymont JKB (1971) Biochemical studies on marine zooplankton. IX. The biochemical composition of Euphausia superba. J Mar Biol Ass UK 51:581-588

SUMMARY OF THE DISCUSSIONS OF THE SUB-GROUP ON
THE PHYSIOLOGY AND BIOCHEMISTRY OF KRILL

Chairman: S. Rakusa-Suszczewski

Rapporteur: D.J. Morris

Present: H. Astheimer, F. Buchholz, A. Clarke, H.-J. Hirsche, M. Huntley, T. Ikeda, P. Mayzaud, D.J. Morris, S. Rakusa-Suszczewski

The main problems under discussion were moulting, growth, longevity, feeding, energetics and biochemistry. The purposes of the sub-group discussions had previously been outlined by the chairman. They were:

1. To find the key for the understanding of the relationship between energy flow and circulation of matter in Antarctic ecosystems. The results should serve as a basis for future modelling.
2. The quantitative evaluation of the energy budget of krill in order to establish a relationship between the biomass and the production of krill with regard to both lower trophic levels (phytoplankton), and competing organisms.
3. The evaluation of the energy budget parameters and their coefficients should allow us to recognize the specific adaptations of krill.

The meeting opened with the completion of a chart prepared by Professor Rakusa-Suszczewski. The function of this was to highlight areas where knowledge was lacking, and it was clear that a major gap was the lack of any data on the chemical composition of the early stages of krill.

However, although in many areas some data were available, the suitability of these data for use in an energy budget were questionable. It was therefore decided to discuss the energy budget from scratch to establish where new data are most needed.

A simple growth model which attempted to mimic the observed growth pattern of krill by superimposing idealised summer periods of production upon a sigmoid curve was presented by Astheimer. It was difficult to evaluate this in the absence of estimates of many necessary parameters. Particular disadvantages were the lack of any data on assimilation efficiency, and the inability to age krill.

Determination of the age of krill, and particularly the use of age-pigments as proposed by Ettershank was discussed in detail. Lipofuscin seems to have great potential as an indicator of "metabolic age", but the seasonal nature of growth in krill means that calibration is against calendar time of vital importance for any application to field samples of krill. It was felt that a clear protocol was needed so that other workers investigating age-pigments could ensure that their methods were comparable to those used by Ettershank, and this would also allow calibrations to be prepared for different areas. It is possible that the relationship between Lipofuscin content and calendar age will vary between different populations of krill. There was general agreement that this looked to be an important development in krill biology, and was deserving of wide publicity.

It was decided that a useful approach for discussing krill energetics would be to re-organise the standard energetic equation, to read:

growth (including reproduction) = energy intake - respiratory
costs

i.e.

$$G = a.F.C. - R$$

where G = growth, C = food concentration, F = filtration or clearance rate, a = assimilation efficiency, and R = total respiratory costs (including costs of feeding and activity).

This approach was discussed and immediately highlighted two problems

1. That oxygen consumption was a complex parameter which required some knowledge of activity during measurement. Since this had not been done in any of the many published data, the latter were best regarded as "routine" metabolic rates and were thus of little use in calculating energy budgets.
2. That knowledge of assimilation efficiency was of paramount importance, but totally lacking in krill. In particular detailed information from copepods (and some initial work on krill) indicated that both assimilation efficiency (a) and clearance or filtration rate (F) were functions of food concentration.

The first point had been discussed in a presented paper, the second had not. It was also noted that the units used varied. Thus physiologists usually expressed flows as energy, biological oceanographers as carbon. It was decided that both methods had advantages and disadvantages, and neither was to be preferred.

Dr. Ikeda indicated that he had a considerable amount of relevant data (many of them for the younger stages), but that these had been obtained at different times. The difficulties of relating different sets of individual experimental results to each other was agreed. The most sensible move would be to attempt to define the major energetic parameters at one go, on the same population of krill. Such a project would require many investigators and a spacious, well-equipped laboratory on shore. It was decided to outline the major features of such a program.

The focus of the program would be the mass budget for growth discussed above, i.e.

$$\text{Growth} = \text{a.F.C.} - \text{R}$$

Reproduction would obviously need to be considered separately.

Assimilation efficiency and clearance rates should both be investigated as a function of food availability (and as a function of food type). Also the respiratory costs should be studied as a function of swimming speed, since this would provide information on both standard metabolism and the cost of swimming.

Such investigations will provide primary energetics data and will form the basis for energy budget computations. In addition, the information on growth will provide a valuable input for field ecology studies.

The sophisticated experiments proposed require land-based studies as ship-board operations are precluded by the need for:

1. complex maintenance apparatus for krill
2. adequate control of the food supply (e.g. algal culture)
3. advanced experimental techniques and equipment
4. long acclimation periods to the laboratory conditions
5. high requirements for laboratory space and
6. a 3-4 month study period, as a minimum.

Acute changes of temperature can affect the physiology of krill markedly, but those changes are difficult to interpret. Studies of the effects of temperature should instead concentrate on studying different populations of krill living in different areas, at the temperature to which they are adapted.

The major proposal of the sub-group is thus the establishment of a long-term multiple investigator physiology program, under the auspices of BIOMASS.

Once the basic physiological parameters have been established, the energy flow through Euphausia superba can be related to the available data on primary production, competition with other zooplankton, predation levels and environmental variations.

SWIMMING AND FEEDING
 OF ANTARCTIC KRILL, EUPHAUSIA SUPERBA
 - SOME OUTSTANDING ENERGETICS AND DYNAMICS -
 - SOME UNIQUE MORPHOLOGICAL DETAILS -
 by
 Uwe Kils

Introduction

The more knowledge we accumulate about physiological and biological data of Euphausia superba the more it appears, that this animal is quite an "extreme" one. We might look upon it as the Elephant is in comparative physiological discussions.

Some characteristics of E. superba:

Unusually high weight (60 times that of Euphausia pacifica).
 Unusually high metabolism for an euphausiid of that size and environment (reflected in a respiration of $1 \text{ mg O}_2 \text{ g}^{-1} \text{ h}^{-1}$, swimming speeds up to $60 \text{ cm} \cdot \text{s}^{-1}$ and a reaction time of 40 ms).
 Unusually high size step between krill and its food (see Tab. 1).

Tab. 1 Size- and weight-relationship between krill and its food.

	Phytoplankton	relation	<u>E. superba</u>
length	$6 \mu\text{m}$	$\frac{1}{10\ 000}$	60 mm
weight	$2.2 \cdot 10^{-10} \text{g}$	$\frac{1}{7000 \text{ mill.}}$	1.5 g

Unusual too is the relationship between energetics and size. Normally bigger animals have a lower specific metabolism (energy per body unit and time unit) than smaller have, with an exponent of 0.6-0.7 to the weight. This is shown in Fig. 1 by the solid line. The reasons for this will not be discussed here, for details see Bertalanffy (1951), Champalbert and Gaudy (1972), Conover (1960), Ivlev (1963), Kils (1982b), Pauly (1979), Winberg (1961). The abundant investigations of euphausiid respiration, however, all find exponents close to 1, what means, that respiration increases much too strong during the growth of the animal (Chekunova and Rynkova 1974, Hirche 1983, Lasker 1966, Rakusa-Suszczewski and Opalinski 1978, Segawa et al. 1979, 1982, Small and Hebard 1967, Voss 1982). There must be some parts in the summ-equation of energy which strongly increase with size or weight. One indication into this direction is described in detail in Kils (1982b) and summarized here: Due to an unusually high underwater-weight (the gravity of adult krill is 1.070 compared to 1.055 of "normal" pelagic animals) krill has to bring up a considerable amount of energy not to loose height. This part of energy for hovering grows even exponentially with weight, as indicated in Fig. 1.

Further hints into this direction are the findings of Antezana et al. (1982), who reports an even overproportional food-intake with increasing animal-size (see Fig. 1) and the well developed gills of adult E. superba (Alberti and Kils 1983).

All these extreme findings make it feasible to expect in krill highly effective functional principles and "welldesigned" morphological solutions.

This paper describes recent experiments of the Antarctic expedition of FS "Meteor" during austral summer 1980/81 around the Antarctic Peninsula, and it presents preliminary results, some regarding swimming, and some feeding.

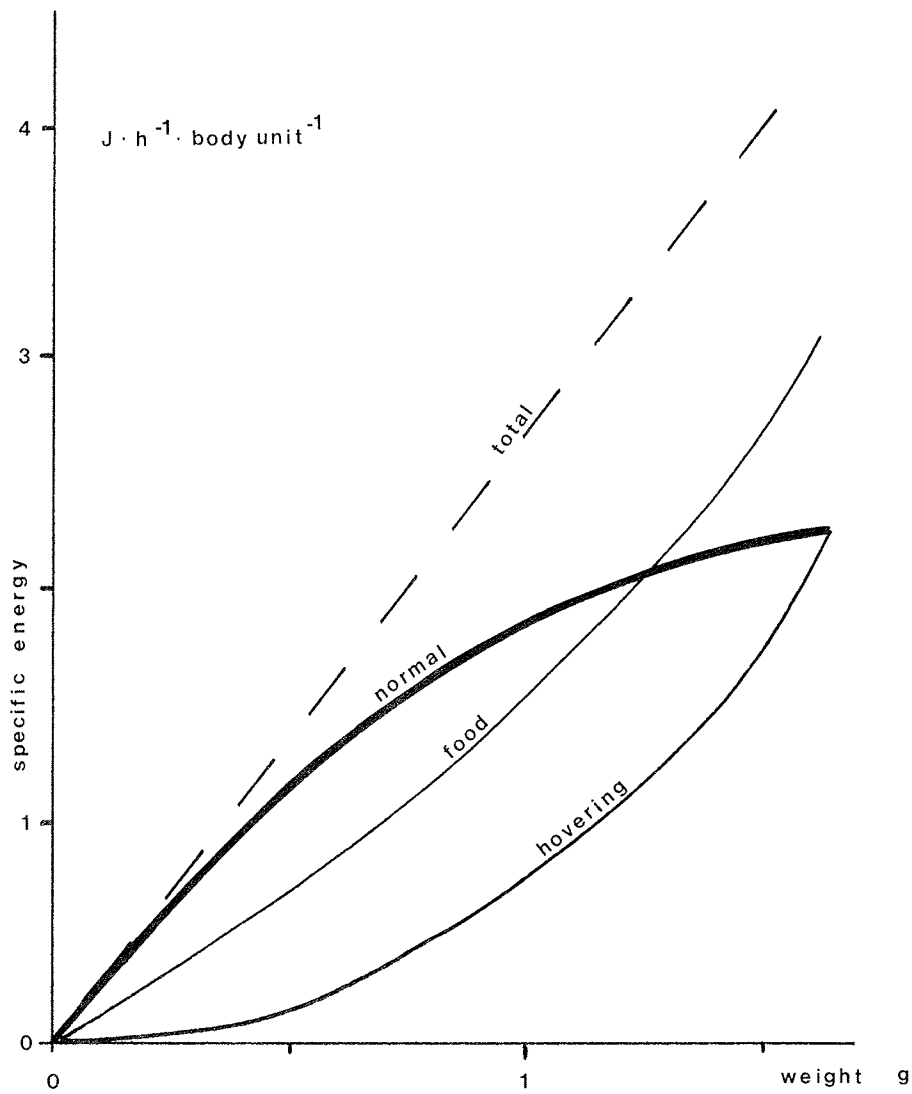

Fig. 1 Tendencies of specific energy in relation to body-weight.
 (scale only correct for hovering)

Methods

Morphological investigations were performed by an especially developed macrophotography system with high speed flashes and lenses with high resolution. Some details were evaluated using a scanning electron microscope (SEM).

For in situ observations we used underwater TV-, film- and photo equipment, combined with a low-light-level tube. This equipment was not lowered directly from the ship but from a non-wave-following buoy.

The forces acting on the krill were measured in a flume (with dead animals), and the forces produced by the krill were measured by glueing a tiny steel-rod onto the carapace (of a living animal), or by indirect methods measuring the water acceleration and flow field produced by a swimming krill.

The reaction-time was estimated by synchronizing a flash to one frame of an already running high-speed film registration. The animals reacted with a beat of their telson, and the frames passed between the flash and this event were counted.

As - in my opinion - the krill is a constantly swimming organism, travelling at a relatively high speed through most of its lifetime, all dynamics should be investigated preferably in such a state. For this purpose a flow chamber was constructed, in which the swimming krill held position relatively to the outside, thus making it accessible to the measurements. This tank (Fig. 2) was built of two perspex tube-sections, one bigger outer one (a), and one smaller inner one (i). At the top and bottom there were sealed plates (p) with sealed lids (l) and sealed probe openings (o). Water was only between the two tube-sections, forming a "water-ring". Into this ring the water was injected tangentially at the inner side through a slit (in), ranging from the top to the bottom. The water-outlet (out) was a net-screened window (5*25 cm), again at the inner side. As a result there is a water-

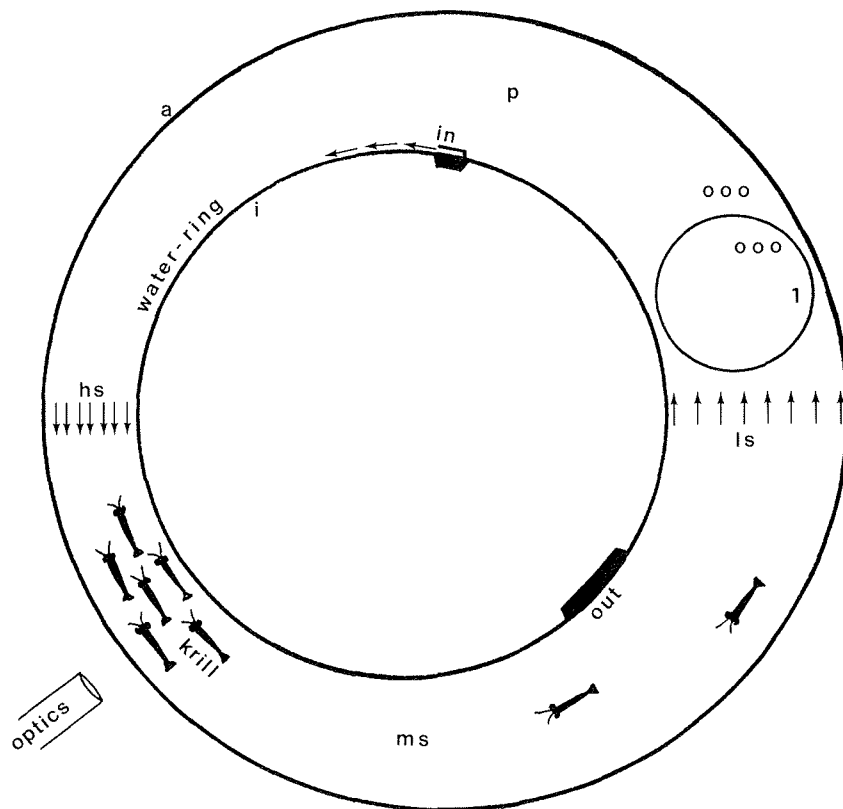

Fig. 2 Schematic top-view of the flow chamber.
(for explanation see text)

current running in the ring, which could be adjusted to the desired range by controlling the inflow. A very important detail is, that the inner and outer tube sections are arranged excentrically. Therefore the cross-section area of the water-ring changes from narrow at the one side (hs) to wide at the opposite side (ls). As the water mass-transport is constant at all sections of the tank, the current has to adopt, and so we find a high water-velocity at the narrow side, and a lower one at the wide side, and - what is even more important - there is a gradual increase in velocity in the areas between these two points (ms).

Engaging this method we were able to offer the krill a variety of water-velocities, so it could freely select an area with a condition suiting its demands. For an example let us consider a krill with a swimming-speed of $10 \text{ cm}\cdot\text{s}^{-1}$; at position (ls) we adjusted the current to $5 \text{ cm}\cdot\text{s}^{-1}$, and at (hs) to $15 \text{ cm}\cdot\text{s}^{-1}$. If this krill is near the area (ls), it swims relatively too fast and will change position ahead ($10-5=+5$) into an area, where it meets a higher current. If it starts out near the area (hs), its swimming-speed is relatively too low ($10-15=-5$), it will fall back into an area, where water-current is lower. After a few seconds there is a balance between swimming-speed and water-current, and the krill stands still relative to the outside. For the investigator this state has several advantages:

- a) Now it is easy to focus optical equipment onto the swimming animal.
- b) The time of this dynamic experiment is nearly unlimited -we ran such a system for several weeks.
- c) As the position of each animal is correlated with its swimming-speed, we can, by simply registrating the animal-position, acquire its swimming-speed.

d) As there are no free water-surfaces, no swapping of the water can disturb water-current or krill, thus making ship-based studies possible on one hand; by measuring the water parameters at the in- and outflow of this controlled waterbody calculations of animal metabolism are possible on the other.

For the animal this system has advantages too:

As they are mainly orientated in parallel to the walls, they nearly never hit against parts of the equipment. Such crashes must be quite a stress considering the normal way of living of this animal and its delicate antenna-system.

Results related to swimming

In an older publication (Kils 1982b) I postulated, that krill is capable - from the energetic and morphological point of view - to travel at a considerably high speed for extended periods of time; therefore we continued experiments into this field. The evaluation of the material has not been completed yet, but what can be said already is, that most of our healthy krill in the above described experimental setup kept up swimming-speeds in the range of 1.5 to 3.5 bodylengths per second for more than a week - through day and night. There was a tendency, that smaller krill travelled with a slightly higher relative speed than the bigger did. There are several other observations of good swimming-capability: Hamner (in press) reported similar speeds from diving observations, Marr (1962) observed a krill swarm swimming against a current at $18 \text{ cm}\cdot\text{s}^{-1}$ for several hours, and in the experiments of Torres and Childress (1983), E. pacifica travelled quite often at speeds between 3 and 6 bodylengths per second.

Many of the dynamics in krill ask for a sensor to detect velocity and direction of the water flowing over the animal (filter-feeding activities or utilizing the hydrodynamic lift as described in Kils 1982b). This sensing seems to be done by

the krill engaging its second pair of antenna. Morphologically this antenna is well suited for such a task: Its cross-section looks like a flat hydrofoil (Fig. 3). If the water flows towards such an "antenna-wing" at no angle of attack the antenna will keep its position; if there is an angle of attack, this will result in a deflection to the one or the other side (indicated by the arrows in Fig. 3 and 4). The position of these antenna during cruising is demonstrated in Fig. 4: They keep an angle of 45 degree to the horizontal on each side, forming a total angle of 90 degree between them, best suited to analyse the direction by splitting it into two vectors.

A change in the water-velocity will cause a change in the hydrodynamic drag and as a result the antennas bend more backwards at higher velocities (demonstrated by the big arrows in Fig. 5, which gives a lateral view of the animal), sensing by this method the speed of swimming.

These findings are the preliminary results from the flow-channel experiments, which have been proven by the underwater TV- and film-observations to some extent. Whether we can find confirmation for this theory at the neurophysiological level must be shown by further experiments.

The measurements of the propulsion force produced by the krill showed a result, which, at first sight, seemed not to fit into the general picture. The metacronally beat-succession of the pleopods would theoretically allow the animal to produce a constant propulsion-force (for details see Kils 1982b). However, the measured forces showed quite an oscillation: The strongest propulsion is produced during the beat of the second pleopod, whereas the fifth pleopod produced only half that force. For a good travelling performance alone this would not be very beneficial, as this will result in a repeated acceleration and deceleration - from the energetic point of view a dissipation. I will come back to this point later on.

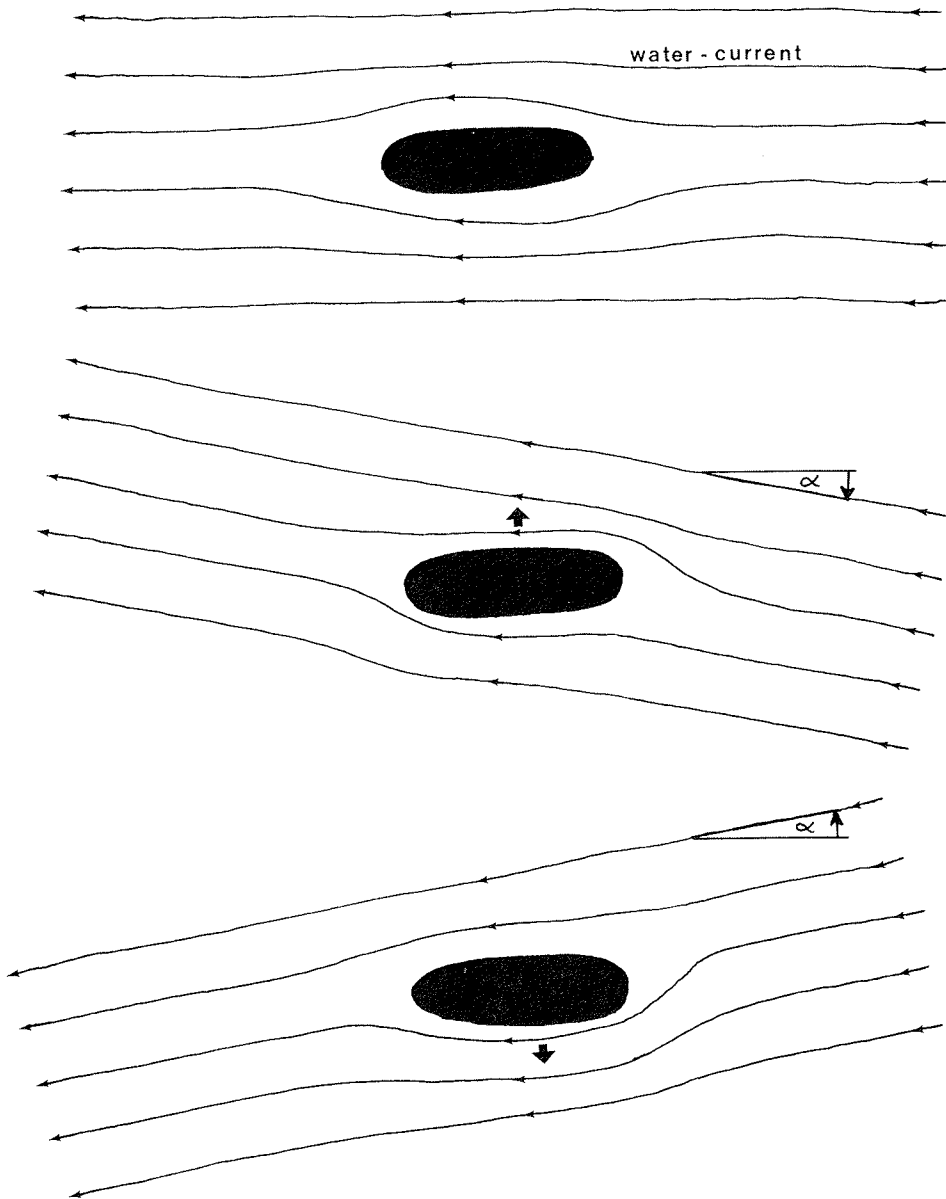
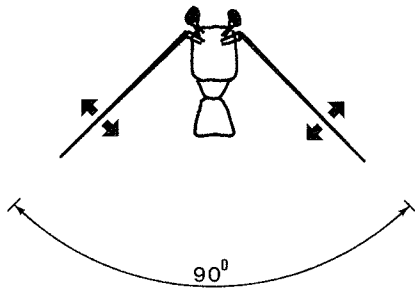

Fig. 3 Cross-section of the second antenna and the hydrodynamic force at different angles of attack. (for explanation see text)

4



5

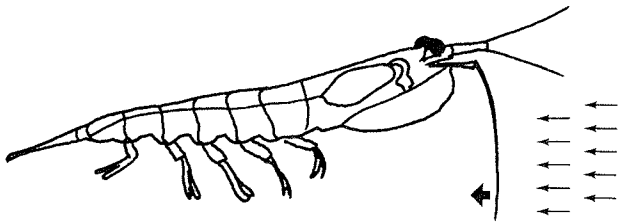

Fig. 4 and 5 Front and side view of krill showing the posture of the second antenna and its deflection by the watercurrent.
(for explanation see text)

The reaction time of krill to optical stimulus is, considering the environmental temperature, very short: 35 to 55 ms. This again is an indication of the extreme metabolism.

A very interesting morphological detail we found at the pleopods. For details of the function and dynamic of the pleopods see Kils (1982b). During their backstroke, the exo- and endopodites are spread out to form a deeply ventral and lateral reaching surface, like a paddle. Left and right pleopod do this synchronized. However, if the spreading to the sides would be too far, a gap in the middle could be the result. To limit this excessive spreading krill developed a connection between the endopodites of both sides, as drawn schematically in Fig. 6 (during the backward stroke): Two bars reach from the inner side of the endopodites to the middleline and form a joint there. This connection does not hamper the folding of the pleopods during the forward stroke, but limits the angle during the backward stroke. Possibly this device aids in pulling the endo- and exopodites apart to form a bigger paddle-area. This detail, though small, is another indication of the very efficiency of the swimming apparatus in krill.

Morphologically there are some more interesting points regarding this connection: It is a secondary reconnection of two extremities; analog would be a joint between the thumbs of our left and right hand. In preserved animals this link is lost, and we are now investigating, how the holding mechanism in alive animals is performed. At what lifestage is this joint developed? What happens during moulting, as this structure it forms a ring?

Results related to feeding

The findings of workers in the field of feeding are quite contradictory: Some find a preference for small food particles and propose a selection, others find the antithesis (Antezana

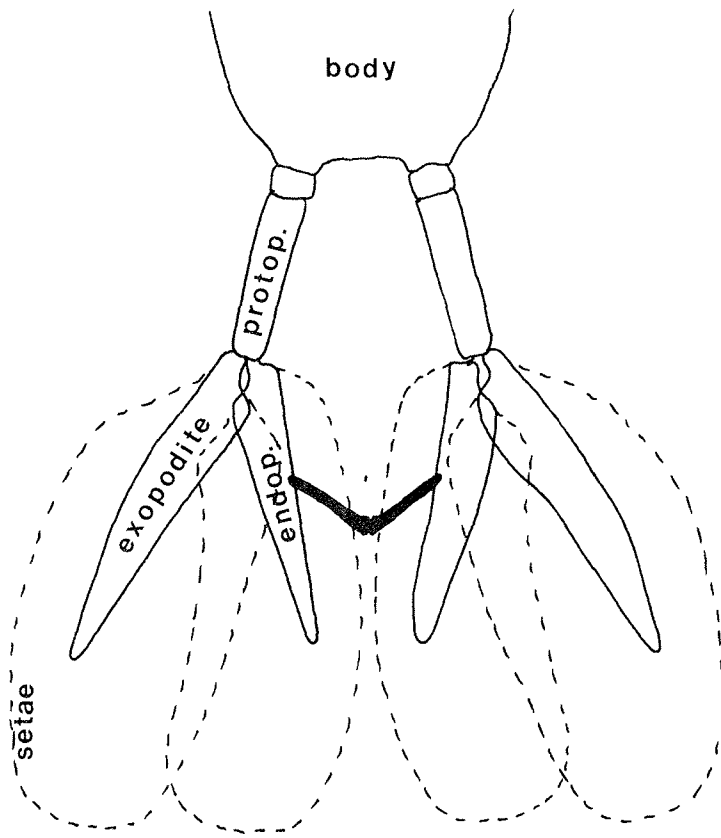

Fig. 6 Front view of a cross-section showing the connection between a pair of pleopods. (drawn solid, schematic)

pers. comm., Barkley 1940, Meyer and El-Sayed 1983, Kawamura unpublished manuscript, Morris unpublished manuscript, Nemoto pers. comm.).

Our results of the evaluation of the high-speed macro-photo-registrations (following the path of particles and analysing the dynamics) led us not to join a special party. However, there is not such one feeding-method but a variety of highly effective skills developed by this animal, so probably all authors are right. Depending on several conditions such as food density, food spectrum, size of krill and probably the energetic state of the animal, different methods are engaged to get the needed energy. In this short presentation it is not possible to describe each method and its morphological and dynamic details, but I want to sum up the basic principles to demonstrate the variability in krill feeding.

The morphology of the filtering basket has been described in detail by Barkley (1940) with recent detail investigation by Alberti and Kils (1980), McClatchie and Boyd (1983), Boyd et al. (in press), Kils (1982a).

The dominant part of the net area is formed by the filter-setae of the thoracopods and has a basic construction as shown in Fig. 7: The 1st-degree-setae (pointing from one thoracopod to the anterior one) carry two rows of 2nd-degree-setae, forming V-shaped micro-nets. The gaps of these nets are half-crossed by 3rd-degree-setae (Fig. 8), resulting in a meshsize smaller than 1 μm . To get an idea of the total net area: One would have to glue 7500 times the Fig. 7 together to display the whole net!

Another important structure is formed by the "comb-setae", shown in Fig. 9. Over ca. 85% of their length they show a rather similar construction as the filter-setae do, but at the very end they carry a comblike device (Fig. 10). These two basic types of setae form two different kinds of nets: One very fine net with a relatively large net area formed by the

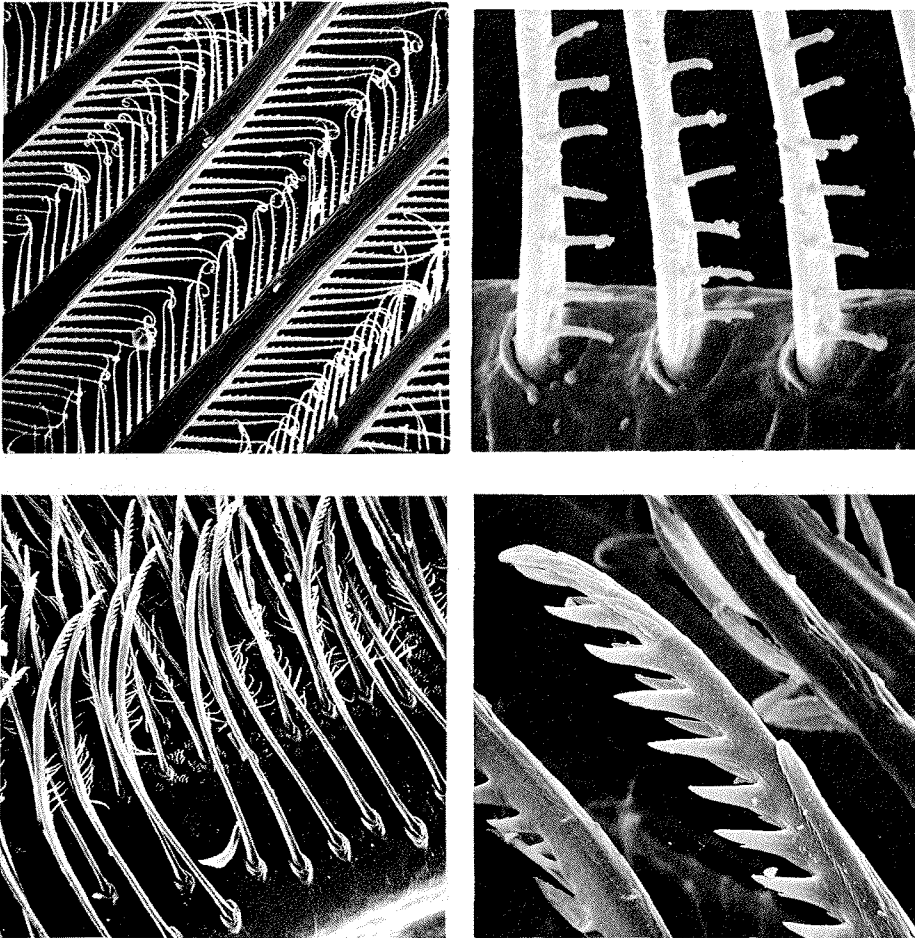

Fig. 7 and 8 (above) SEM-photos of filter-setae (x530 and x6170).
Fig. 9 and 10 (below) SEM-photos of comb-setae (x130 and x1255).
(for explanation see text)

filter-setae (meshsize 1-4 μm), and one coarse net with a comparatively small net area formed by the basal parts of the comb-setae (meshsize 25-40 μm).

One feeding-behavior we often observed is a "pump-filtering" or "compression-filtering": The filtering basket is periodically opened and closed by swinging the thoracopods to the side and front, then pulling them towards the middle-line, and finally drawing them back towards the body. Such a pumping-behaviour is also reported by Antezana et al. (1982), Boyd et al. (in press), Hamner (in press), McWhinnie (pers. comm.). This pumping is generally synchronized with the beat of the pleopods (frequency between 1.5 and 3 beats per second). The details happening during the course of one beat are manifold and will only be scratched here: Fig. 11 shows a schematic 3-dimensional view of the left side of the filtering basket during the opening phase. At this stage the thoracopods travel forward-outwards. The arrangement of the comb-setae is at right angle to the direction of travel. As a consequence the water passes the 30 μm comb-setae-nets from the outside to the inside, and particles bigger than 30 μm are rejected. At the same time the very ends of the comb-setae travel through the meshes of the filter-setae-net, collecting particles caught there at the stroke before and moving them a little bit towards the mouth.

In the second phase (during the movement of the basket towards the middle-line) the filter-setae swing their free end onto the inside of the anterior thoracopod, acting like a valve and closing the net of the comb-setae. Inside the filtering-basket is now water containing all the particles smaller than 30 μm . During the movement of the thoracopods to the inside, this water body is compressed. Part of this water body is pressed out through the posterior comb-setae-nets of the last thoracopods, and the other portion is forced through the fine net of the filter-setae. The relation of those two water portions has not been estimated yet. As the tiny structures of the filter-setae bring about quite low Reynolds numbers, such a net has

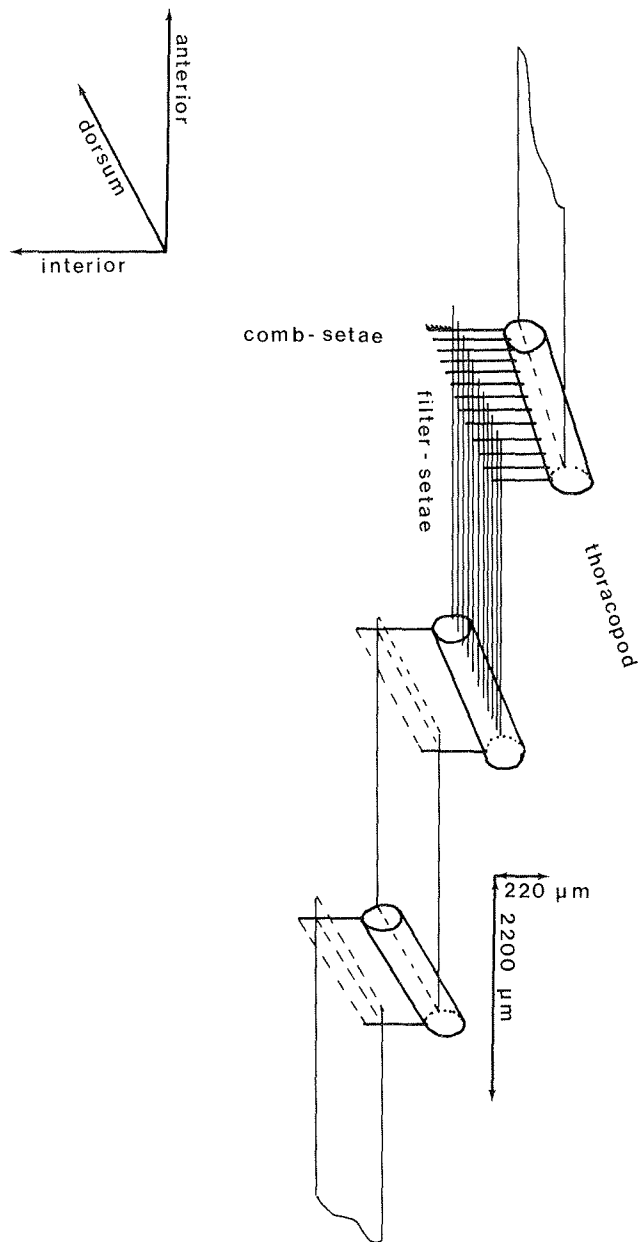

Fig. 11 Schematic 3-dimensional view of the left side of the filtering basket.
(only two net-areas are drawn in detail)

an extreme high drag, and it depends strongly on the pressure inside the filtering-basket, how much water really passes the fine filter-setae-net. For details of fluid-mechanics see Joergensen (1983). As net structures and food particles range in the size of μm , it is not unrealistic to expect, that electrostatic forces might play an important part in collecting particles at the filter surfaces.

To give an impression of the two nets in comparison with the ambient food in Fig. 12 the meshes of the nets are drawn schematically at the same scale as the food is.

Anyhow, by using this method krill can reject selectively particles bigger than $30 \mu\text{m}$ on one side, and the $1 \mu\text{m}$ meshes are small enough on the other side, to catch even bacteria.

The above described pump-filtering could be observed when there was abundant food in the water, and in my opinion this is the filtering-method krill performs most of the time. The evaluation of the underwater-films confirmed this belief and so does the following: As the moment of the opening of the filter-basket is correlated with the highest drag (Kils 1982b), now it makes sense to have the propulsion force of the pleopods oscillating, and indeed the moment of highest thrust of the pleopods coincides with the moment of the opening of the basket. So if we take both, the swimming-dynamics and the filtering-dynamics into account, we now find a balanced and smooth force-budget - a prerequisite for economic and continuous performance.

Another type of pump-filtering with a slightly different succession of thoracopod movements is similar to a "back-flushing" of the filter-setae-net: During the movement to the outside the water enters the basket across the 1st-degree-setae, while the V-shaped nets formed by the 2nd-degree-setae swing back like an opening valve. This behaviour was often correlated with very thick plankton conditions and a considerable decrease in swimming speed of krill.

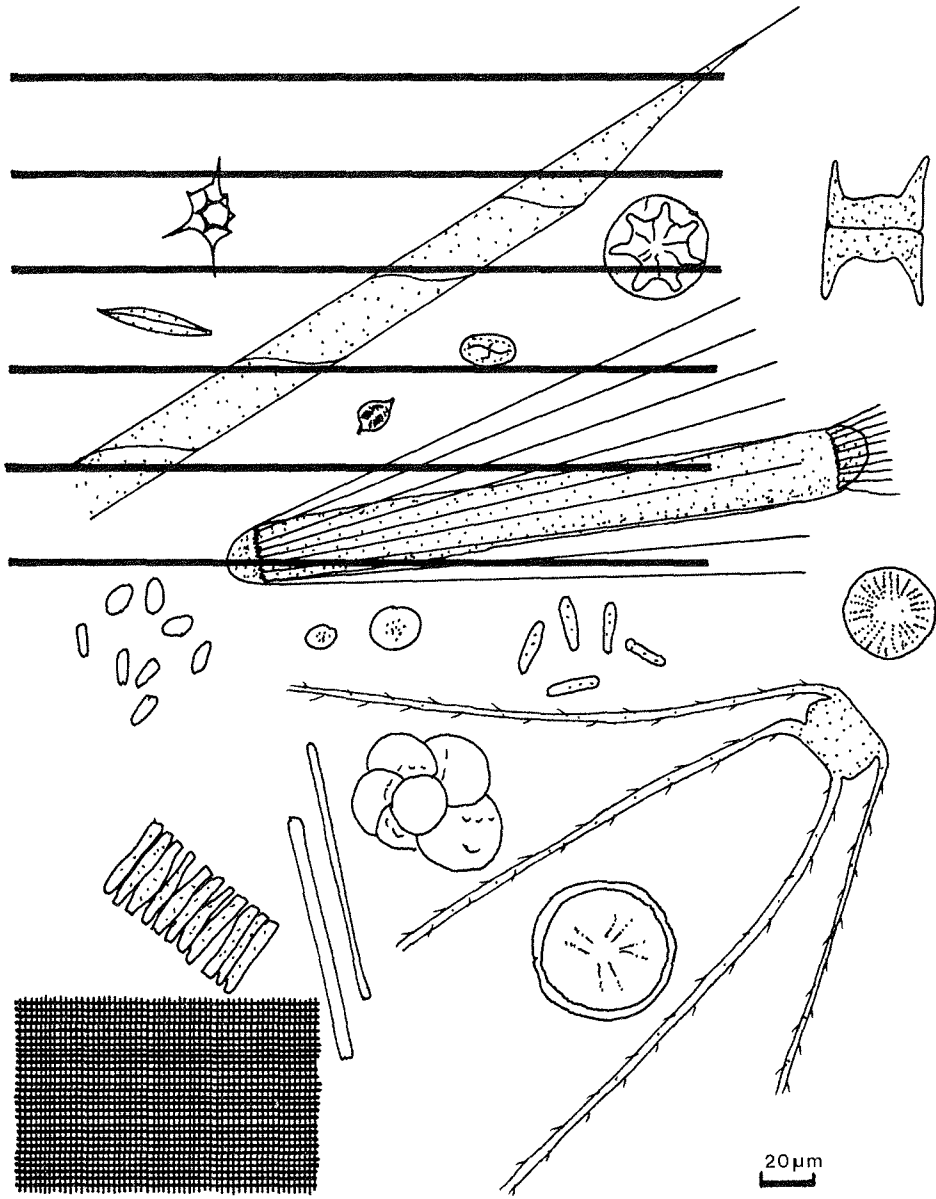

Fig. 12 Size-relationship between ambient food organisms and the filtering-nets. Comb-setae-net : Top solid bars
 Filter-setae-net: Left lower corner

At lower food availability we observed krill travelling with a steadily opened basket for quite a distance, followed by a couple of pump movements. Fig. 13 shows an animal at such a state. This figure has been drawn directly from a photographic registration, so that the proportions are realistic. This feeding-method will not reject particles bigger than 30 μm . It might be a "get all there is" method. Here the portion of water passing the filter-setae-net is certainly very small, as during the phase of open tow there is only a small pressure increase inside. At this low pressure condition the function of the filter-setae-net shifts: It predominately acts as a deflector to channel the water across the comb-setae-nets, but a though small portion of the water might still pass the fine net.

If there is nearly no food in the water, the basket is folded close to the body; this of course is senseful, as the open filtering-basket produces quite a drag (see Kils 1982b), consuming a lot of energy.

Summarizing the filtration process it can be said, that krill developed extreme skills, covering diverse methods, thus utilizing a wide variety of available plankton conditions. All principles for good net construction are fulfilled: The smaller mesh size:

- a) the lower the towing speed,
- b) the bigger the net area,
- c) the shorter the towed distance and
- d) the higher the pressure and

this all realized in one apparatus and partially even at the same time. The complex processes can only be scratched in this presentation, and will be described in more detail in a separate publication.

Besides suspension-feeding krill has a variety of additional opportunities: Cannibalism has often been reported, and we filmed (in aquarium) several animals incorporating a colleague

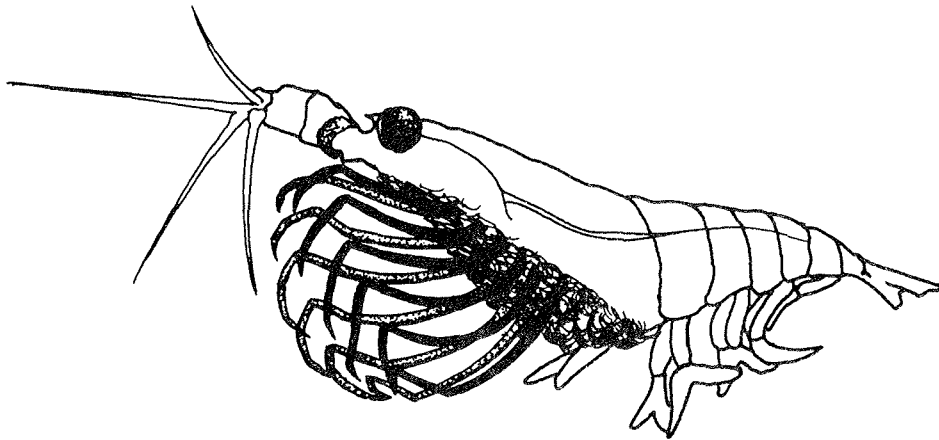

Fig. 13 Three-dimensional view of the filtering basket from front-below, showing the posture during the phase of open tow. Drawn directly from a photographic registration. Right thoracopods drawn solid, left dotted. Second antenna and exopodites of the thoracopods omitted.

totally within few hours, preferably "white" krill or krill stuck in the old exuvie during moulting. Maybe other big zooplankton can be caught too, as the krill exhibits quite a skill in using the two sides of the basket to grab bigger objects.

The dactylopodites of the thoracopods carry rake-like structures, which show quite a different morphology than the normal setae: They are much stronger and increase in diameter from the tip to the base. Their static points to the fact, that they are well suited for grazing diatoms from the ice or other surfaces, a behaviour that has often been reported. Fig. 14 gives a summary of the different feeding methods.

Discussion

The fascinating morphological structures of the filtering-basket, the unique functional principles of the filtration dynamics, the extreme performances in metabolism, the well developed gills, the high feeding rates and the susceptibility of the adults to unfavourable conditions are for me all indications, that the adult krill is spending its life at a kind of physiological frontier: Energy-expenditure is enormous on one side and highly efficient and adaptive energy-supply-systems are needed on the other. This is a living at high risk, as even a relatively small trouble or change in the environment can lead to a catastrophe. But krill shurely is the most abundant animal of its size range in the world, so this species really can effort to take such a risk, and the profit is high: Living in a very attractive oceanic community.

If we consider krill to be a more or less constantly travelling organism, this has quite some implications to our general understanding of its biology. As the crusing speed is size-dependent, a mixed swarm will dissociate after some time in one swarm ahead consisting of big animals and one swarm behind consisting of small animals. Also, the synchronisation in moulting, as reported by Buchholz (this volume), could be

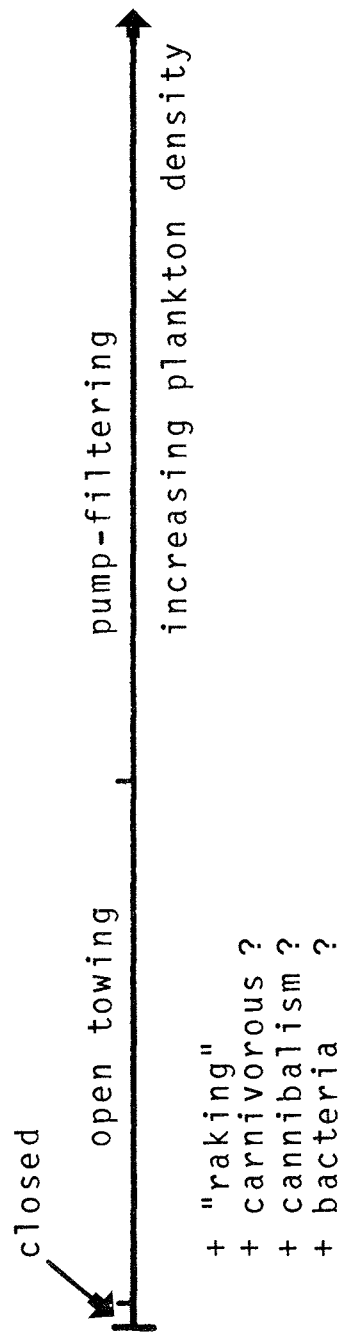

Fig. 14 The different feeding methods in relation to plankton-density.

caused by the inability of freshly moulted individuals to keep up with a moving swarm, thus falling behind and then gathering again with the other "moulters" to form a new swarm. All individuals of this new swarm will then moult together the next time.

The investigations of Denys (pers. comm.) showed structures in the eyes of krill suspected of sensing polarized light. This might enable a swarm to navigate, to migrate over great distances into one direction. A report of Guzman (this volume), citing Kanda et al. (1982), supports such an idea: They followed two swarms over 46 and 116 miles travelling at a speed of $15 \text{ cm}\cdot\text{s}^{-1}$ in a south general trend. If we make the two assumptions, that we have animals migrating at constant direction and at a constant speed and take into account the hydrography of the Southern Ocean with its turbulences, we might develop a theory for the unevenly large-scale distribution of krill: In Fig. 15 the parallel arrows represent the swimming-vectors of evenly distributed swarms. The circular arrow-system represents the superimposing current-vectors of an eddy. As the cruising speed of a krill swarm can be about $15 \text{ cm}\cdot\text{s}^{-1}$ and the rotation-velocity of an eddy can be about $20\text{-}40 \text{ cm}\cdot\text{s}^{-1}$, the parameters are not too far from reality. And the assumption of having krill-swarms travelling for some period into one direction might not be too odd, as bird-swarms and insect-swarms do so. The additions of the two vector-systems are drawn as the solid arrows. In such a system after a while there will be much more krill swarms in the shaded area, and many of the new entering swarms will be caught in the eddy.

I am quite aware of the fact, that this model is very hypothetical, but I think it might be worth while to investigate into such directions to find out more about this fascinating animal and ocean.

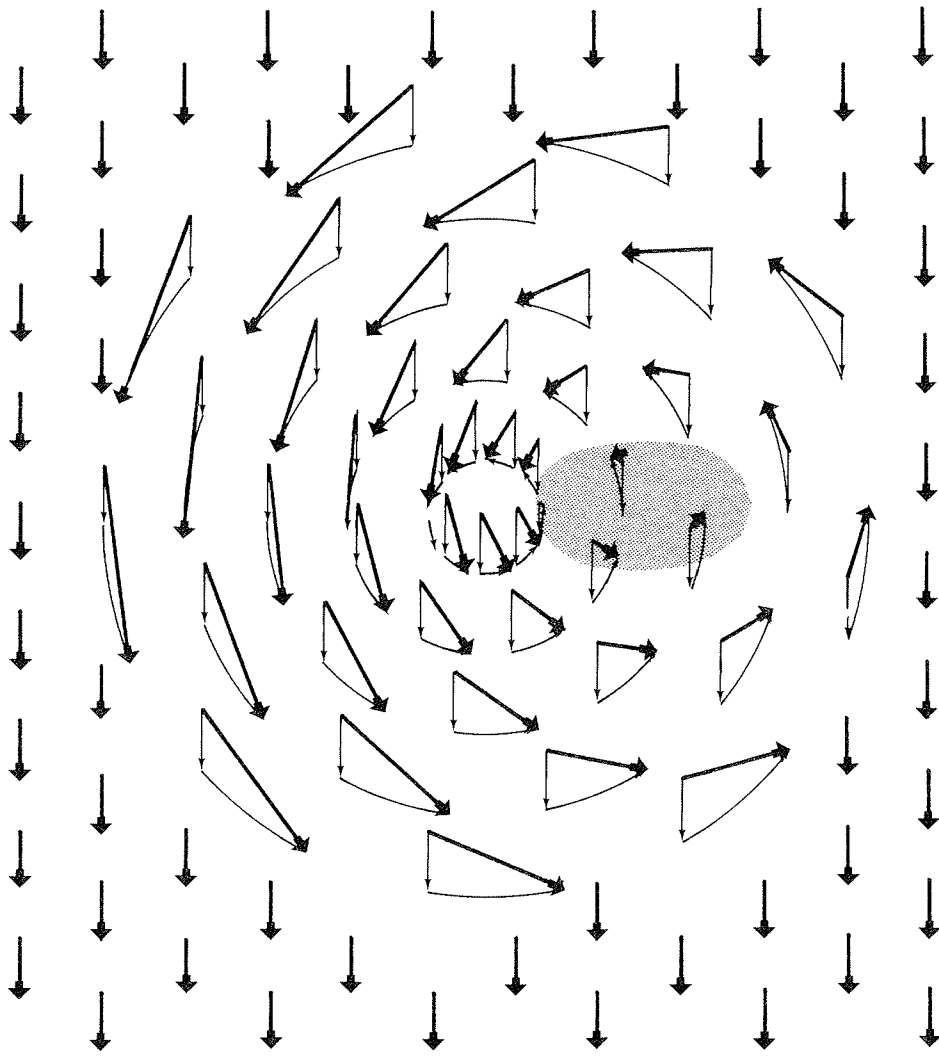

Fig. 15 Hypothetic gathering effect of a superimposed eddy.
There are much more swarms in the shaded area.
(for explanation see text)

References

- Alberti G, Kils U (1980) The filtering-basket of Euphausia superba. ICES CM 1980/L:54
- Alberti G, Kils U (1983) Light- and electron microscopical studies on the anatomy and function of the gills of krill (Euphausiacea, Crustacea). Polar Biol 1:233-242
- Antezana T, Ray K, Melo C (1982) Trophic behaviour of Euphausia superba Dana in laboratory conditions. Polar Biol 1:77-82
- Barkley E (1940) Nahrung und Filterapparat des Walkrebschens Euphausia superba Dana. Z f Fischerei und deren Hilfswissenschaften, Beiheft 1, Walforschung 1:65-156
- Bertalanffy L von (1951) Theoretische Biologie - Zweiter Band: Stoffwechsel, Wachstum. A. Francke AG Verlag, Bern, 418pp
- Boyd C, Heyraud M, Boyd C (in press) Feeding of the Antarctic krill, Euphausia superba. J Crust Biol
- Buchholz F (1983) Moulting and moult physiology in krill. (This volume)
- Champalbert G, Gaudy R (1972) Etude de la respiration chez des copepodes de niveaux bathymetriques varies dans la region sud marocaine at canarienne. Mar Biol 12:159-169
- Chekunova VI, Rynkova TI (1974) Energy requirements of the Antarctic crustacean Euphausia superba Dana. Oceanology 14:434-440
- Conover R (1960) The feeding behavior and respiration of some marine planktonic Crustacea. Biol Bull Mar Biol Lab, Woods Hole 119:399-415
- Guzman O (1983) Distribution and abundance of the Antarctic krill (Euphausia superba) in the Bransfield Strait. (This volume)
- Hamner W (in press) Aspects of schooling in Euphausia superba. J Crust Biol
- Hirche H (1983) Excretion and respiration of the Antarctic krill Euphausia superba. Polar Biol 1:205-209
- Ivlev V (1963) Energy consumption during the motion of shrimps. Zool, Zh 1465/1471 (Engl. summary)
- Joergensen C (1983) Fluid mechanical aspects of suspension feeding. Mar Ecol Prog Ser 11:89-103
- Kanda K, Takagi K, Seki Y (1982) Movement of the larger swarms of Antarctic krill (Euphausia superba) population off Enderby Land during 1976-77 season. J Tokyo Univ Fish 68:25-42

- Kils U (1982a) The unique position of krill in the Antarctic system. Joint Oceanographic Assembly (Abstracts). SCOR Department of Fisheries and Oceans, Scientific Information and Publication Branch, Ottawa, Ontario, Canada
- Kils U (1982b) Swimming behaviour, swimming performance and energy balance of Antarctic krill, Euphausia superba. BIOMASS Scientific Series 3:1-121
- Lasker R (1966) Feeding, growth, respiration and carbon utilisation of a euphausiid crustacean. J Fish Res Bd Can 23:1291-1317
- Marr JWS (1962) The natural history and geography of the Antarctic krill (Euphausia superba Dana). Discovery Rep 32:33-464
- MaClatchie S, Boyd C (1983) A morphological study of sieve efficiencies and mandibular surfaces in the Antarctic krill, Euphausia superba. Can J Fish Aquat Sci 40:955-967
- Meyer MA, El-Sayed SZ (1983) Grazing of Euphausia superba Dana on natural phytoplankton populations. Polar Biol 1:193-197
- Pauly D (1979) Gill size and temperature as governing factors in fish growth: A generalisation of von Bertalanffy's growth formula. Berichte aus dem Institut für Meereskunde 63, Kiel
- Rakusa-Suszczewski S, Opalinski W (1978) Oxygen consumption in Euphausia superba. Pol Arch Hydrobiol 3:633-641
- Segawa S, Kato M, Murano M (1979) Oxygen consumption of the Antarctic krill. Trans Tokyo Univ Fish 3:113-119
- Segawa S, Kato M, Murano M (1982) Respiration and ammonia excretion rates of the Antarctic krill, Euphausia superba Dana. Trans Tokyo Univ Fish 5:177-187
- Small F, Hebard J (1967) Respiration of a vertically migrating marine crustacean Euphausia pacifica Hansen. Limnol Oceanogr 2:272
- Torres J, Childress J (1983) Relationship of oxygen consumption to swimming speed in Euphausia pacifica. 1. Effects of temperature and pressure. Mar Biol 74:79-86
- Voss J (1982) Sauerstoff-Verbrauch des Antarktischen Krill, Euphausia superba. Diplomarbeit, Universität Kiel 1982
- Winberg G (1961) New information on metabolic rate in fishes. J Fish Res Bd Can Trans 362

ESTIMATION OF KRILL ABUNDANCE

by

Inigo Everson

Requirements for estimating krill abundance

Depending on the circumstances, estimating the abundance of krill can mean a wide variety of things. In its simplest form it can mean estimating the total number or total weight of krill present in the Southern Ocean. Such an exercise, whilst providing answers of some interest is of little value ecologically. In studying living resources, because of their capacity for renewal, we are interested in not simply abundance but rates of change in abundance. Although this is an extension of the basic requirement it is an essential component of ecosystem models and highlights one specific application of abundance estimation.

In the context of ecosystem models abundance estimation may be considered in several additional ways. The predator/prey interaction poses additional questions concerning abundance estimation. Consider, for example, two species of penguin breeding on an isolated island. The critical time of year occurs when the chicks are being fed. At this time the area over which the adults can search for food is governed by their swimming speed and the time between feeds. In the case of the Gentoo and Macaroni Penguins this indicates foraging ranges of 31.5 and 115 km respectively (Croxall in press). Thus the areas over which the two species can search and feed are markedly different. Krill are known to have a strongly aggregated distribution and hence are unlikely to be evenly distributed over the whole area but more likely to be present in local patches of high concentration (Fig. 1). A concentration of a given size may only be available to one predator (Fig. 1a) or totally to one and in only a limited way to the other (Fig. 1b). This abundance estimation needs to be defined

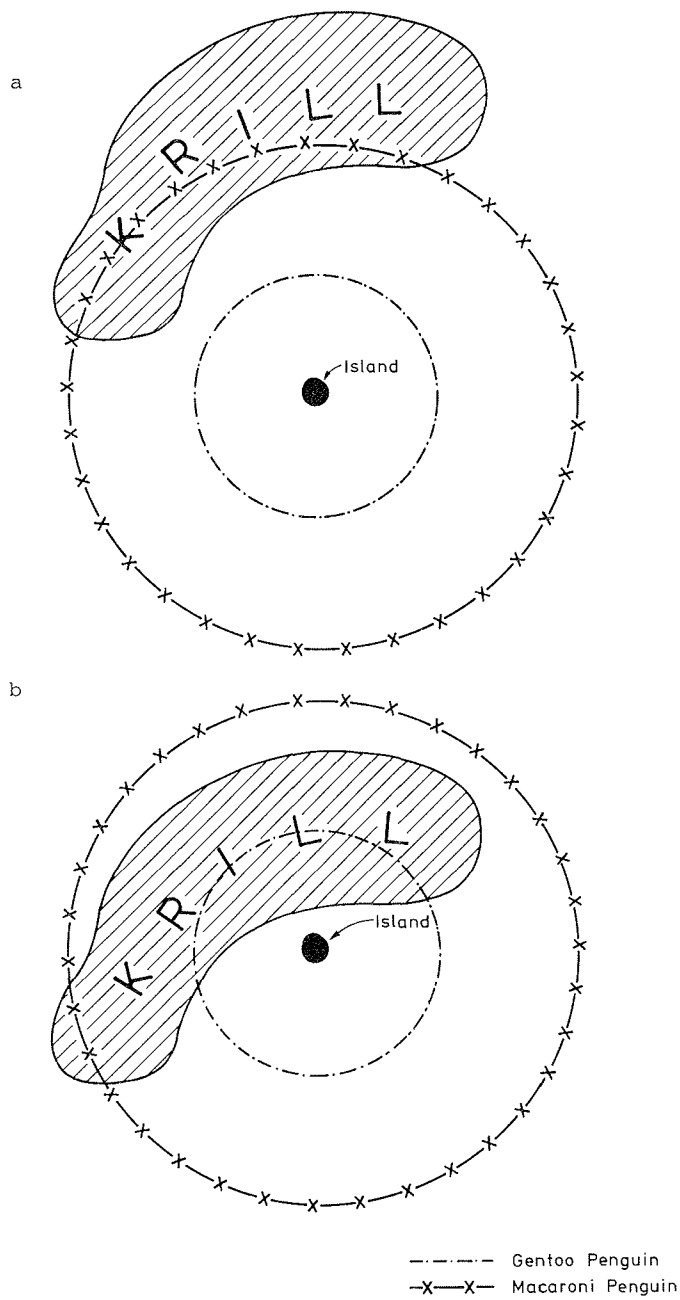

Fig. 1 Hypothetical map indicating foraging ranges of two penguin species in a situation where a patch of krill is distant (1a) and close (1b) to the island on which the birds breed.

within defined geographical localities. Implicit in this is a requirement to know the environmental conditions associated with regions of abundance which in turn requires a knowledge of water movements.

Predators are not only separated geographically. The wide diversity of krill predators are able to forage over differing depth strata that may be classified into several groups (Tab. 1).

Tab. 1 Classification of krill predators by foraging depth range.

<u>Type</u>	<u>Range</u>	<u>Examples</u>
Unrestricted	Surface to bottom	Fish, squid
Deep diving	Surface to 600 m	Whales, Weddell Seal
Shallow diving	Surface to 250 m	Penguins, seals
Surface	Surface to 2 m	Albatross, petrels etc.

The vertical distribution patterns of krill are complicated and poorly understood. Although no simple pattern has been recognised it may be stated that by day krill tend to be deep whilst after dark they tend to be at or near the surface. Such a rhythm will mean that krill will only be available to surface feeding predators for a brief period of the day or night (Fig. 2). Furthermore the proportion of the total krill available that are within the foraging range of such predators would be strictly limited.

Thus there are good reasons for considering abundance estimation in terms of locality and depth. Such an approach does, however, mean that all krill are usually susceptible to predation. Recent evidence indicates that this is not the case and that there is significant selection for particular

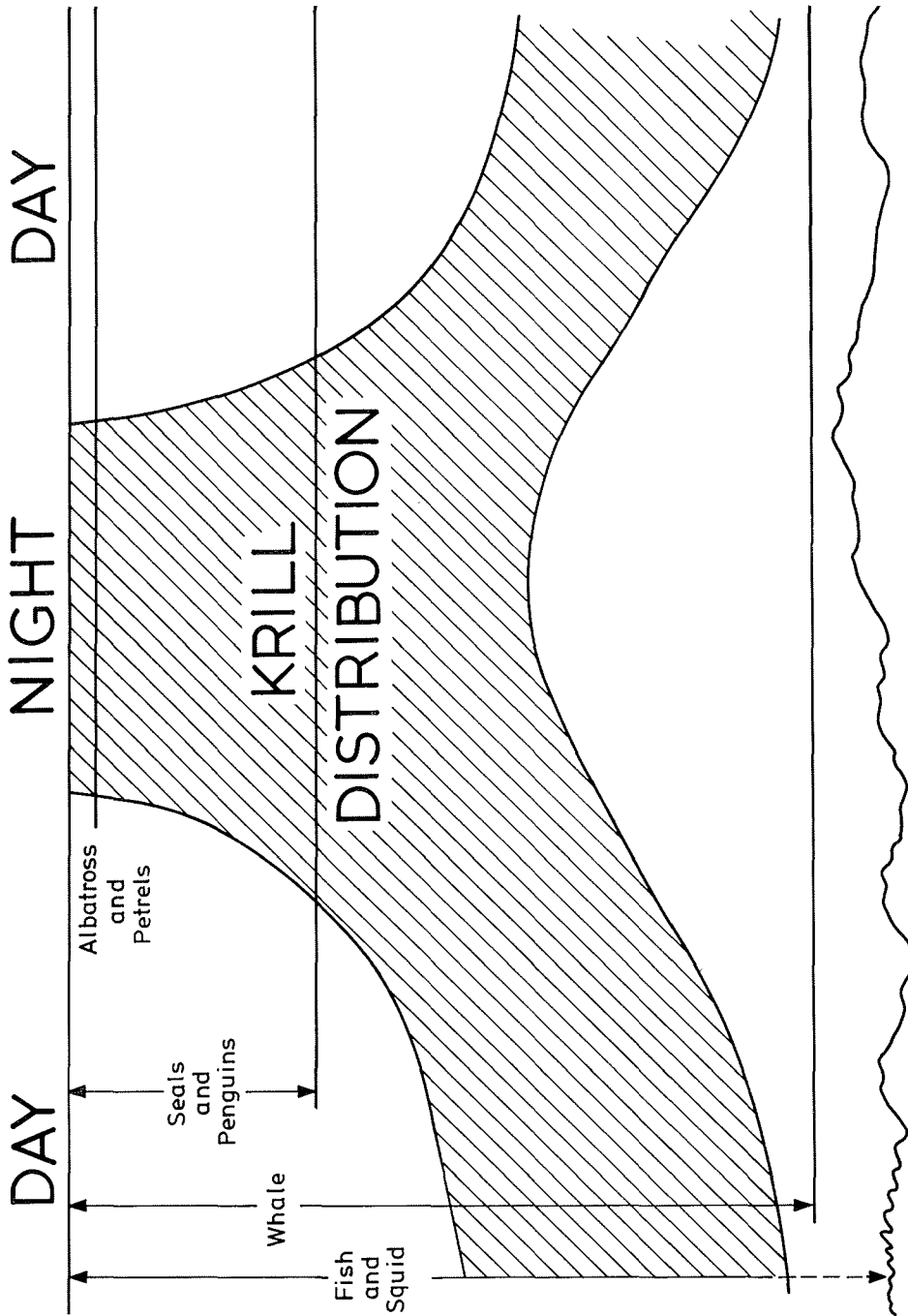

Fig. 2 Stylised indication of the vertical distribution of krill with respect to the foraging depths of major predators.

classes. Based on an extensive series of samples Croxall and Prince (1980) showed that the major krill predators are feeding on krill of 50 mm total length or larger. Krill of this size represent only a small proportion of those present around South Georgia, the bulk of the biomass being composed of much smaller individuals. This indicates a significant level of selection for larger krill.

There is also selection by density of swarms. Nemoto (this symposium) has demonstrated that baleen whales feed only on dense swarms of krill and do not feed when krill are dispersed.

The estimation of krill abundance, if it is to have value on understanding the interactions within the ecosystem, is not just a single question. Rather it should be thought of as a series of estimates which are based on defined geographical and depth limits.

Methods of estimating krill abundance

Remote sensing

The possibility of estimating krill abundance using satellite imagery has long been an attractive one. At present, however, there is no evidence to suggest that this technique can provide any useful direct estimates. However, satellite data may prove useful in indicating water circulation patterns and this information will be of use in stratifying data from abundance estimation surveys by other methods.

Nets

Net sampling offers two distinct advantages. Firstly nets are capable of sampling over the full depth range of the krill. Their second advantage is that what was caught was undoubtedly present within the depth stratum sampled. This second point may seem trite but there have been instances when other methods indicate krill are absent when simultaneous net hauls

have produced krill. The inference in such circumstances must be that 'krill were present albeit at low density' rather than 'such low densities are insignificant when compared to swarms'.

There are certain problems, or disadvantages associated with net sampling. The most obvious problem is that of gear selectivity and this factor may operate in two ways. Nets having coarse meshes such as commercial midwater trawls are capable of catching large krill but the smaller krill pass through the meshes. This introduces a bias into the size frequency distribution of the catch although this can be compensated for by comparing catches using nets of differing mesh size. The second selectivity problem is that of avoidance. Large krill being more powerful swimmers are more able to avoid sampling nets than small krill. Unlike mesh selection this is an active form of selectivity whose effects are dependent on net type and the prevailing conditions. These may be considered under several headings:

<u>Factor in design or Operation of net</u>	<u>Likely avoidance effect</u>
1. Towing wire and bridles in front of net mouth	Increase
2. Net size	The larger the net the less the effect of avoidance.
3. Mesh size	Fine meshes likely to clog easily resulting in pressure wave at mouth increasing avoidance.
4. Colour	Black or dull coloration reduces visual clues and hence reduces avoidance.

- | | |
|----------------------|--|
| 5. Fast towing speed | Krill less able to avoid net but increased speed increases pressure wave and hence increases warning to krill. |
| 6. Slow towing speed | Krill given less warning by pressure wave. Avoidance depends on visual clues. |
| 7. Time of day | Darkness will reduce visual clues and hence avoidance. |
| 8. Sampling depth | Increased depth reduces light level and hence avoidance. |

Ideally a krill sampling net should be large, have nothing that in any way obstructs the general area of the mouth, be coloured dull black, have a mesh size small enough to catch all post larval stages of krill but large enough not to clog with phytoplankton. The optimum towing speed of the net should be such as to minimise the pressure wave at the mouth. Nets are thus most effective after dark and at depth, situations only likely to be present for part of a sampling programme. Determination of correction factors to be applied when the situation is less than ideal poses great problems particularly in differentiating between effects caused by net selectivity and those others associated with krill behaviour.

A further problem associated with net sampling is that from the point of view of abundance estimation the amount of data per net haul is low and each haul takes a significant amount of time. This restricts the number of samples that can be obtained in a reasonable time. This problem is exacerbated by the contagious nature of the krill distribution causing the variance to be high.

Hydroacoustics

Increased sophistication coupled with reliability has meant that hydroacoustics is now a recognised and standard method for estimating fish abundance. The technique has also been used with success to detect and quantify krill.

A typical echosounder arrangement is shown in Fig. 3. The transmitter produces a series of high frequency pulses which radiate into the water from the transducer. The transducer is so designed that nearly all the energy is concentrated into a single, conical beam. Solid objects within the beam cause the sound to be reflected in all directions. Some of this reflected sound will reach the transducer and the resultant signal is amplified by the receiver. Since the beam is conical the sound level declines with range (r) from the transducer by a simple squared function which in decibel notation becomes $20 \log r$.; also the sound level is attenuated by the water. These two factors, often referred to as the spreading and attenuation losses, mean that echosounders have a finite range for detection. They also mean that the echo level at the transducer for two identical targets will depend on their range. To make the echo level independent of range a time varied gain function (TVG) is incorporated into the system often in the receiver amplifier. The signal is then passed to a recorder and an integrator.

The hydroacoustic method has several distinct advantages. Firstly the time delay between the transmission pulse and the return echo can be measured very accurately thus giving a very fine depth discrimination. Secondly since the echosounder can operate effectively when the survey vessel is travelling at speed, large areas can be covered in reasonable time. Thirdly because the pulse repetition frequency is quite high sampling along a transect is effectively complete. In addition to these theoretical advantages the stability of modern electronic

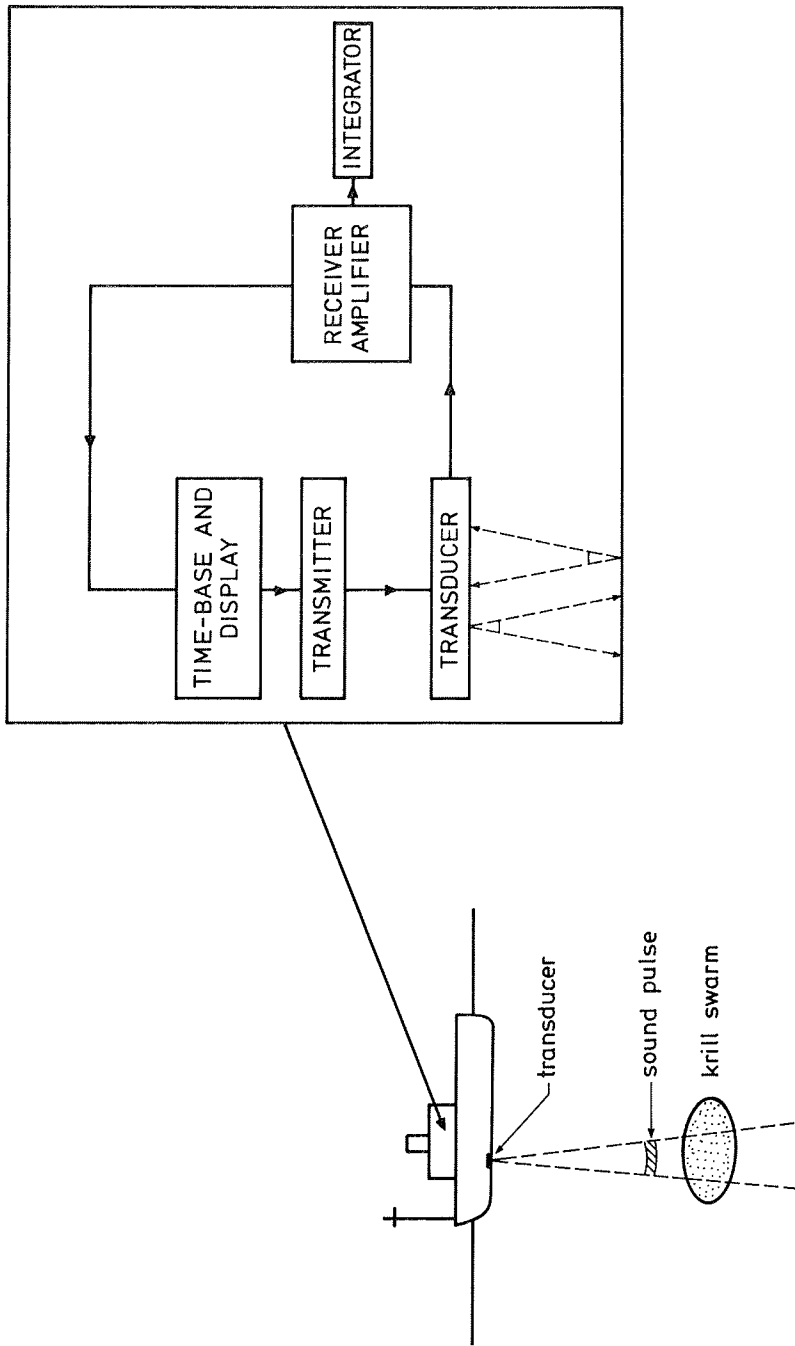

Fig. 3 Diagram of principal components of a quantitative echosounder.

circuitry means that consistent results are possible and that realistic comparisons can be made between individual installations.

There are unfortunately some difficulties associated with the acoustic technique. The echo integrator is measuring echo levels irrespective of the targets that caused the echo. In situations where there are likely to be several species present, unless the species cause different and recognisable patterns on the echochart, they cannot be differentiated directly. This situation can be extended to consider sizes and life history stages of krill and the only way of resolving it is by net hauls aimed at specific targets. Since only a very small proportion of targets can be sampled in this way a degree of judgement has to be employed in assigning species and life history stages to individual acoustic indications. In practice the error is probably not great.

A second problem with the acoustic method is that the effective depth range is limited. The spreading and attenuation losses mentioned above mean that at 120 KHz, a commonly used frequency, the effective quantitative range is probably no more than 250 m. Since the bulk of the krill appear to be in the top 100 m this is probably a minor disadvantage although it should be borne in mind that krill swarms have been detected as deep as 400 m. Of greater significance is the fact that krill do occur at the surface and are therefore above the level of downward directed hull mounted transducers. The unsampled layer is from the surface to about 10 m, a stratum of particular significance in the context of avian predation. In theory this layer could be sampled using towed, upward-directed transducers although there is no published information to confirm this.

To convert the acoustic data into abundance measurements a scaling factor, the target strength (TS), is required. Bearing in mind that relatively small errors in TS, since it is measured on a logarithmic scale, cause large errors in

abundance estimates it is important that it is accurately determined. The major factors affecting TS are summarised below:

1. Krill size - proportional to TS.
2. Reproductive state - gravid females have a higher total lipid content and thus TS.
3. Behaviour - krill orientated at right angles to the sound field will have a higher TS.
4. Echosounder operating frequency.

The method for determining TS, whilst being relatively simple, is not easy to perform in the South Ocean. The need for these measurements is recognised so that we can expect reasonably accurate figures in the not too distant future.

A more significant problem is that of determining a minimum detectable level for krill. It is not uncommon in situations when echosounders and nets are used simultaneously for the echosounder to indicate that no krill are present and yet the net catches krill. Such observations can be explained by assuming that the two devices did not sample the same water and the net sampled small swarms outside the echosounder's beam. The probability of such a situation arising must be very low which would tend to indicate that such an occurrence would be very rare. It is a situation that is more frequent than this explanation would suggest it ought to be. An alternative explanation is that the krill are so widely dispersed that they go undetected by the echosounder, i.e. there is a minimum detectable level.

An echosounder transmission pulse of 1 ms duration is effectively 1.5 metres long and because of the conical beam pattern the sampled layer is increasing with range. A single target of low TS may not produce a sufficiently strong echo to be detected by the receiver or to be seen above the background noise level. Two similar targets within a single pulse length may however give a detectable echo which although twice that

of a single target would be only slightly greater than the threshold value. As range increases so does the sampled volume (beam pattern) but this is more than offset by the reduced signal level due to spreading and attenuation. Thus it is possible for low levels of krill abundance to go undetected. This then begs the two related questions:

1. What is the minimum detection level?
2. Does it cause an unacceptable error in abundance estimates?

Currently we do not have answers to either question but if the minimum detection level were, say, one krill per 10 m^3 and this were evenly distributed around an island such as South Georgia the undetected biomass would be over a million tonnes.

Conclusions

The sheer size of the area covered by the distribution of krill allied to shortcomings in the available sampling methods means that there is no single method that should be applied. The optimal method must in turn be determined paying respect to the aims of the survey. Thus, accepting that the needs for individual abundance estimates will require different combinations of sampling techniques, we can outline a generalised plan, the major components of which would be as follows:

- Acoustic - Major source of abundance data using both downward and upward directed transducers.
- Nets - Define size range and life history stage of krill. Depending on effectiveness of acoustic techniques also abundance estimates in "low abundance regions".
- Oceanography - Provide information on oceanographic features so as to assist stratification of sampling and analysis.

There are also key topics which warrant further investigation and these may be summarised as follows:

- Acoustics - Target Strength of krill
- Minimum Detection level
- Nets - Selectivity.

The methodology for estimating krill abundance is reasonably well developed; with further studies in the specific fields mentioned above it will become a valuable component of ecological models of krill.

References

- Croxall JP (in press) Seabird ecology. In: Laws RM (ed) Ecology of the Antarctic. Academic Press, London
- Croxall JP, Prince PA (1980) The food of Gentoo Penguins Pygoscelis papua and Macaroni Penguins Eudyptes chrysolophus at South Georgia. Ibis 122:245-253

DISTRIBUTION AND ABUNDANCE OF ANTARCTIC KRILL
(EUPHAUSIA SUPERBA) IN THE BRANSFIELD STRAIT

by

Oscar Guzmán

Summary

The main results about abundance, distribution and behavior of Antarctic krill (Euphausia superba), obtained during the first three Chilean expeditions (January-March 1975; May-June 1976; September-October 1976) and during FIBEX (February 1981) are presented. The most important conclusions deduced are: krill maintains an important biomass and shows swarming behavior along the year in the Bransfield Strait; under the pack-ice that surrounds the South Shetland Islands during winter, high larvae densities (furcilia V-VI) and juvenile krill (< 15 mm) were found. Finally, the possible ecological process that enables the occurrence of the mentioned behavior, is discussed. The marine currents prevailing in the zone and the influence of the rise and reflux of the pack-ice could be the most important factors for the distribution of the advanced larval stages (furcilia V-VI) as well as for the recruitment of the juvenile krill from the adult population fraction.

Introduction

In 1974 the Instituto de Fomento Pesquero (IFOP) commissioned by the Corporación de Fomento de la Producción (CORFO) started a longterm scientific and technological research programme in order to decide the feasibility of an Antarctic krill fishery development. This research programme that finished in 1979, was mainly orientated to study the abundance and distribution of the resource, the most efficient systems for its capture, the environmental conditions of the investigated area, the alternatives for its industrial processing and the marketing possibilities of several products.

Three expeditions were done to the Weddell Sea and the Bransfield Strait, to catch the necessary raw material and to carry out the food technology research. These expeditions took place within the following dates:

1st expedition: From 1st January to 27th March 1975 on board Valparaíso side trawler.

2nd expedition: From 8th May to 11 June, 1976 on board Arosa VII factory vessel.

3rd expedition: From 23rd September to 22nd October 1976 on board Arosa VII factory vessel.

Later on in 1980, the Instituto Antártico Chileno (INACH) coordinated and sponsored the FIBEX project done in February 1981 in the Bransfield Strait, following the agreements of the Technical Group on Implementation of BIOMASS. In the development of this project, IFOP was in charge of the krill assessment applying hydroacoustical methods and the zooplankton survey. The ship used was the "Itzumi" belonging to the "Undersecretariat of Fisheries".

Materials and methods

During the first expedition performed in summer 1975, only a SIMRAD E.Q. echo sounder of 38 KHz was used, to find out about the relative krill distribution and abundance (Guzmán 1981).

During the second and third expeditions, a SIMRAD EK-120 echo sounder was used with a source level (SL) of 215.3 dB/μ Pa. ref. 1m. and a voltage response (VR) of -107.8 dB/1V μ Pa.

The controls setting of this equipment were: pulse length 06 ms; pulse repetition frequency 96 p.p.m.; bandwidth 10 KHz; receiver gain 0 db TVG 20 Log R. For the purposes of quantification an echo integrator SIMRAD QM-MK-II was utilized, setting its echointegration channels over the range of

10-100 m, using different gains to avoid equipment saturation in densest aggregations, but at the same time having a good resolution for low densities.

The only difference between the equipment described above and that used during the FIBEX expedition, was that a SIMRAD EK-120 echo sounder was employed with a pulse repetition rate of 125 p.p.m. that had a SL = 215.5 dB/μ Pa. ref. 1 m and a VR = 107.3 dB/μ Pa. With the purpose to integrate the whole water column, where krill is distributed during summer time, the channel A of the echo integrator was applied in 10 and 100 m, and B in 100 and 200 m. Considering that the TVG function of that echo sounder only covered up to 100 m, the integrated millimeters below this depth were corrected.

The echo integration constant considered to transform the integrated voltage, in absolute densities (ton/nmile²), was:

$$\hat{C}_b = 8.88 \text{ (ton/nmile}^2\text{/mm)} \quad \text{(Guzmán 1981)}$$

The mean target strength per krill specimen, deduced from the results of this calibration was $\overline{TS} = -65.1 \pm 1.8$ dB, considering a mean size per specimen of 46 ± 13 mm (T.L.).

Taking into account that this constant was calibrated during the FIBEX expedition, it was necessary to correct it in order to apply it to the obtained data in the expeditions carried out during 1976, according to the transmission (SL) and reception (VR) characteristics of the utilized echo sounder, to be able to compare the abundance estimates.

With regard to the considered sampling procedure applied to estimate krill abundance, during the expeditions carried out in 1976 the simple random method was applied (Snedecor and Cochran 1967) and during FIBEX the cluster sampling method (Hansen et al. 1953).

Results

In Figs. 1 to 4 the surveyed areas are shown and the places of highest krill abundance, detected during the four Chilean expeditions. In Tab. 1 the corresponding estimated biomass is given.

Tab. 1 Estimated krill biomass during Chilean surveys.

Survey	\hat{B}_0 (ton)	Conf. Lim. (ton)	Area (nm ²)	e_a (ton/nm ²)
IFOP (May-Jun, 1976)	513,700 (*)	<u>+150,000 (**)</u>	3,360	153
IFOP (Sep-Oct, 1976)	598,100 (*)	<u>+ 55,000 (**)</u>	8,014	75
FIBEX-INACH (Feb, 1981)	902,200	<u>+170,000</u>	5,890	153

Notes:

- (*) Corrected values applying the calibrated echo integration constant during the FIBEX survey $\hat{C}_b = 8.88$ (ton/nmile²/mm).
- (**) Underestimated confidence limits.

Even though, during the first survey done in March 1975, krill was not quantified in absolute terms, it was possible to assert, that the abundance detected during that summer was significantly higher in relative terms compared to the ones found later at the beginning of winter and in spring (Guzmán 1981). This was confirmed in 1981 when during the FIBEX survey it was possible to quantify an abundance of 902,000 tons, that is 35% higher than the ones estimated for winter and spring.

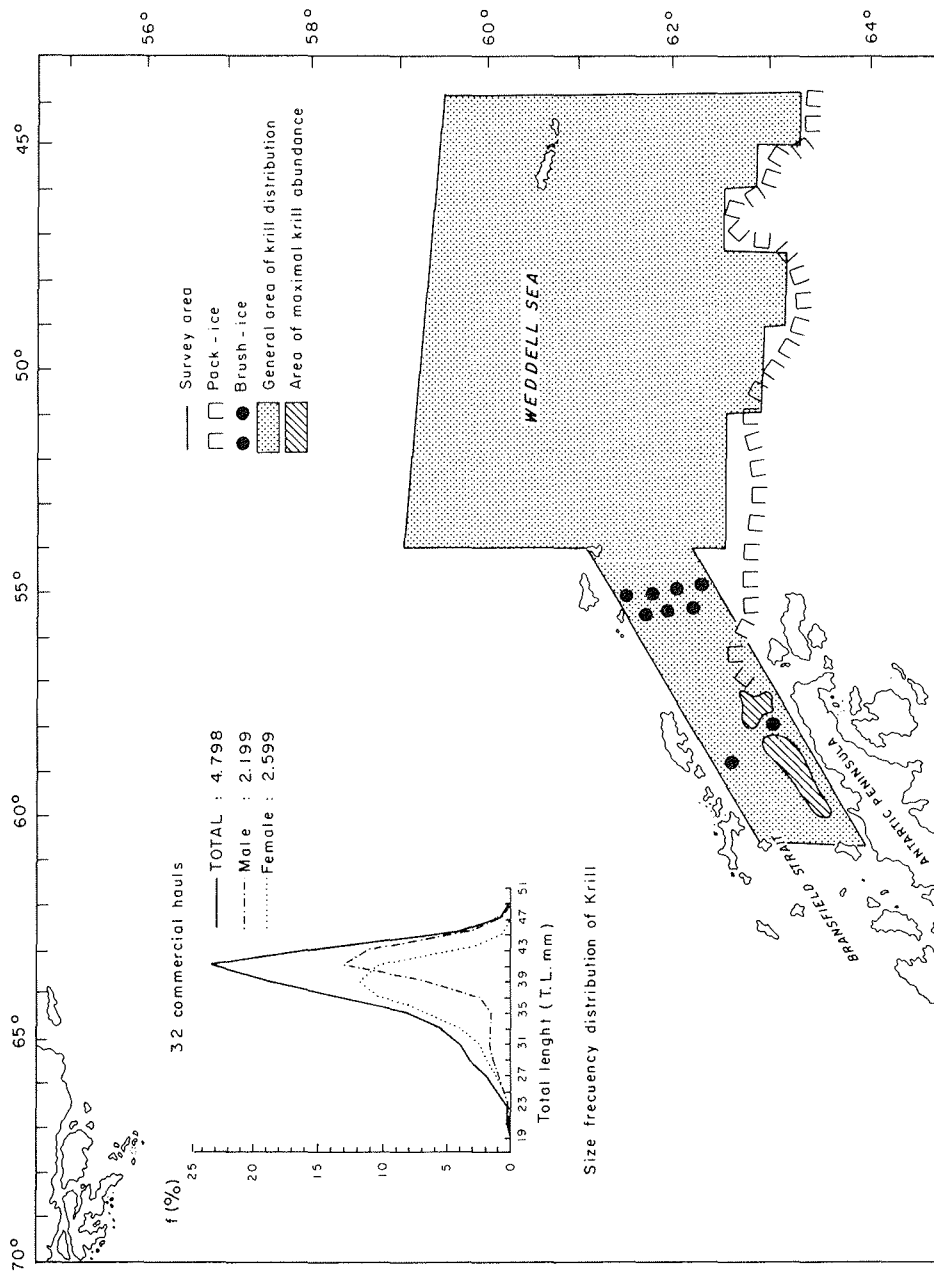

Fig. 1 Krill (*Euphausia superba*) biomass distribution detected during the first Chilean expedition (Jan.-Nov. 1975). Source: Guzmán 1981

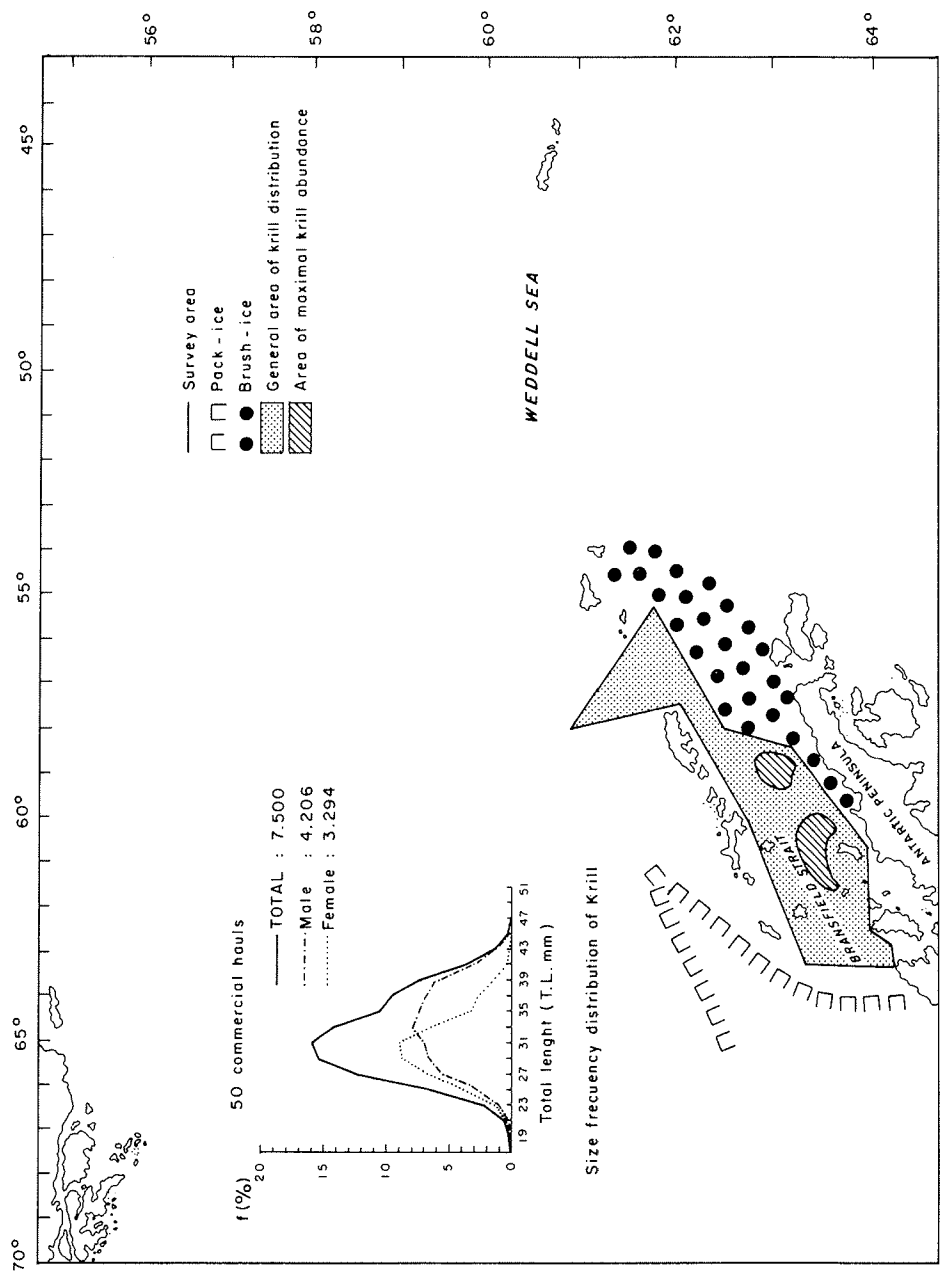

Fig. 2 Krill (*Euphausia superba*) biomass distribution detected during the second Chilean expedition (May-Jun. 1976). Source: Guzmán 1981.

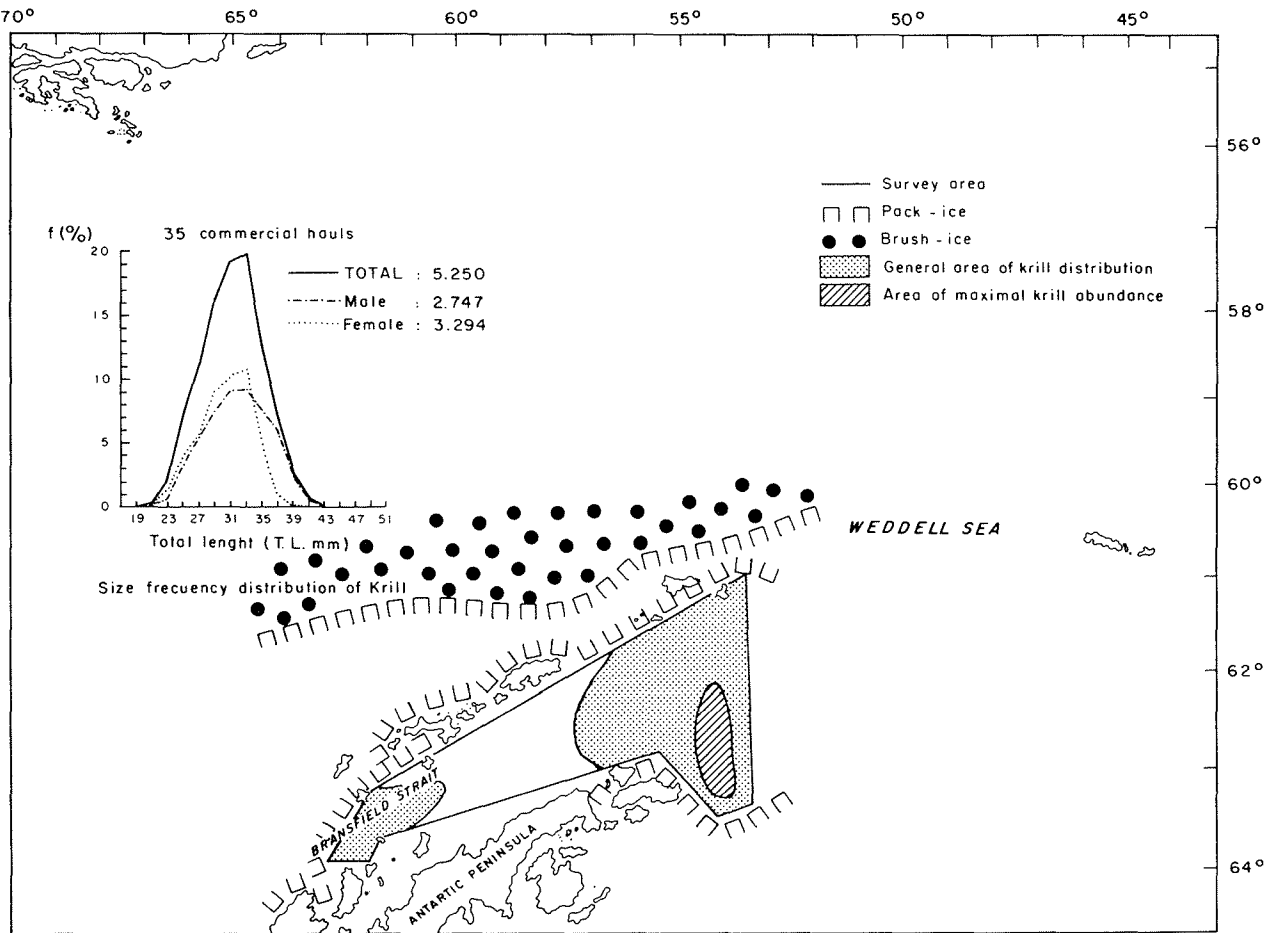

Fig. 3 Krill (*Euphausia superba*) biomass distribution detected during the third Chilean expedition (Sep.-Oct. 1976). Source: Guzmán 1981.

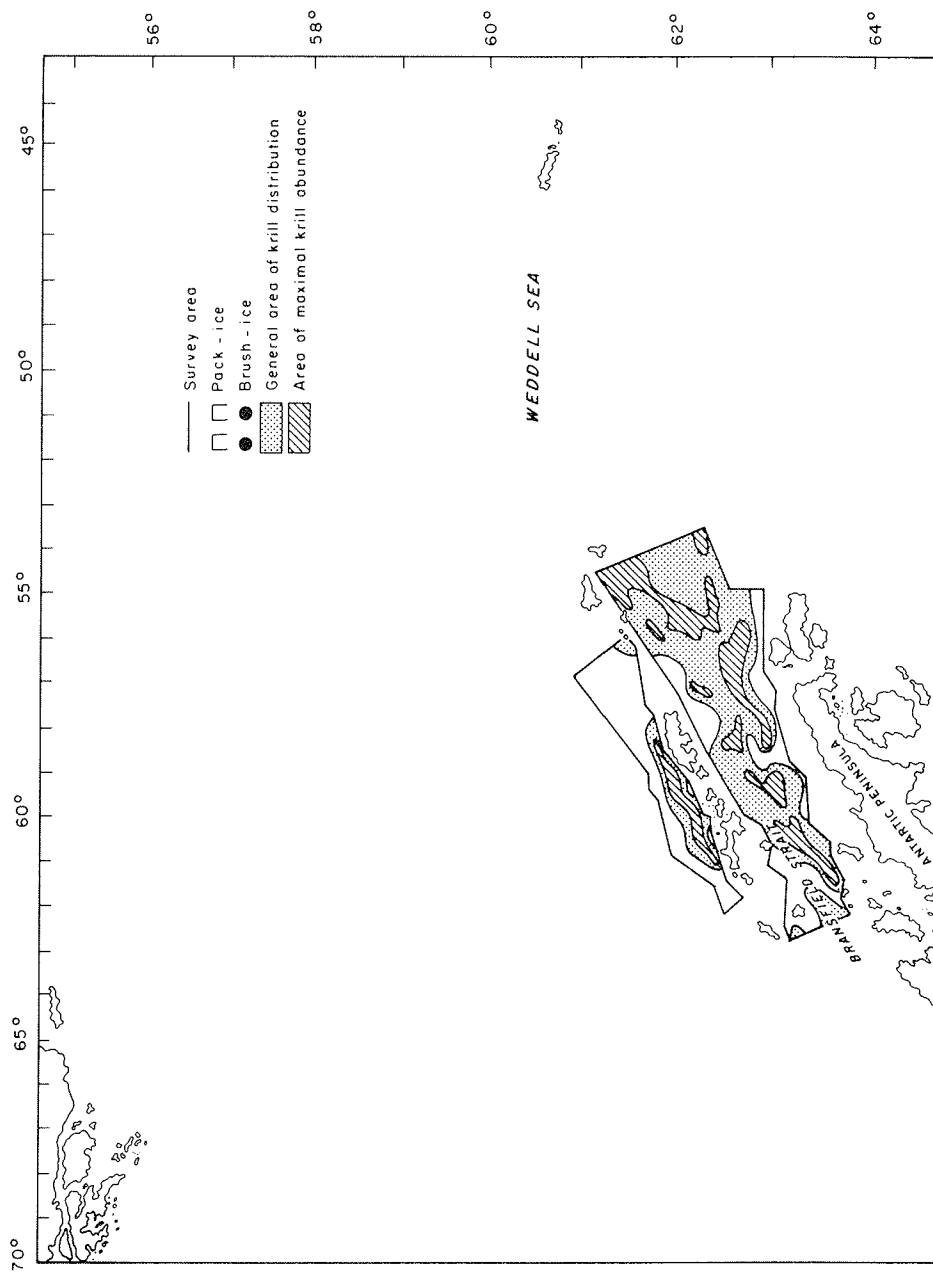

Fig. 4 Krill (*Euphausia superba*) biomass distribution detected during the Chilean FIBEX expedition (Feb. 1981). Source: Lillo and Guzmán 1982.

A common element observed during winter and spring surveys was that krill formed aggregations that maintained the tendency to migrate up to the surface, between 06.00 and 20.00 hours, this tendency being a little bit less sharp at the beginning of spring.

The fact of having applied different depth intervals during the surveys done in 1976 (5-100 m) with respect to 1981 (10-220 m), does not nullify the possibility to compare the estimated biomass, since the greatest depth that krill reached during winter and spring generally did not exceed 100 m.

The important seasonal fluctuations that the krill abundance experiments in the Bransfield Strait (500,000 tons in autumn - 900,000 tons in summer) showed, may be the product of a massive death rate of adult specimens, probably of the third annual class, occurring at the end of summer after they have completed their last reproductive cycle.

Up to a certain extent, the above mentioned opinion can be verified with the size distribution graphics of krill specimens captured during the surveys done by IFOP (Fig. 1 to 3), between 1975 and 1976 (Rojas 1979). In spite of the fact that they were obtained by means of industrial fishing gears, which shows certain selectivity for the smaller sizes, their distributions are comparable in relative terms, because the utilized lining inner net had the same mesh size (20 mm).

In 1976, when going through the pack-ice fields in the Drake Passage in order to enter the Bransfield Strait (Fig. 5), underneath the solid ice a large quantity of larvae (furcilia V to VI) and juvenile krill (< 15 mm) were observed, their intestinal tract showing a green colour, probably due to the ingestion of microorganisms that grow under the ice. This fact represents an important difference, compared to those specimens of larger sizes that formed aggregations at higher depths

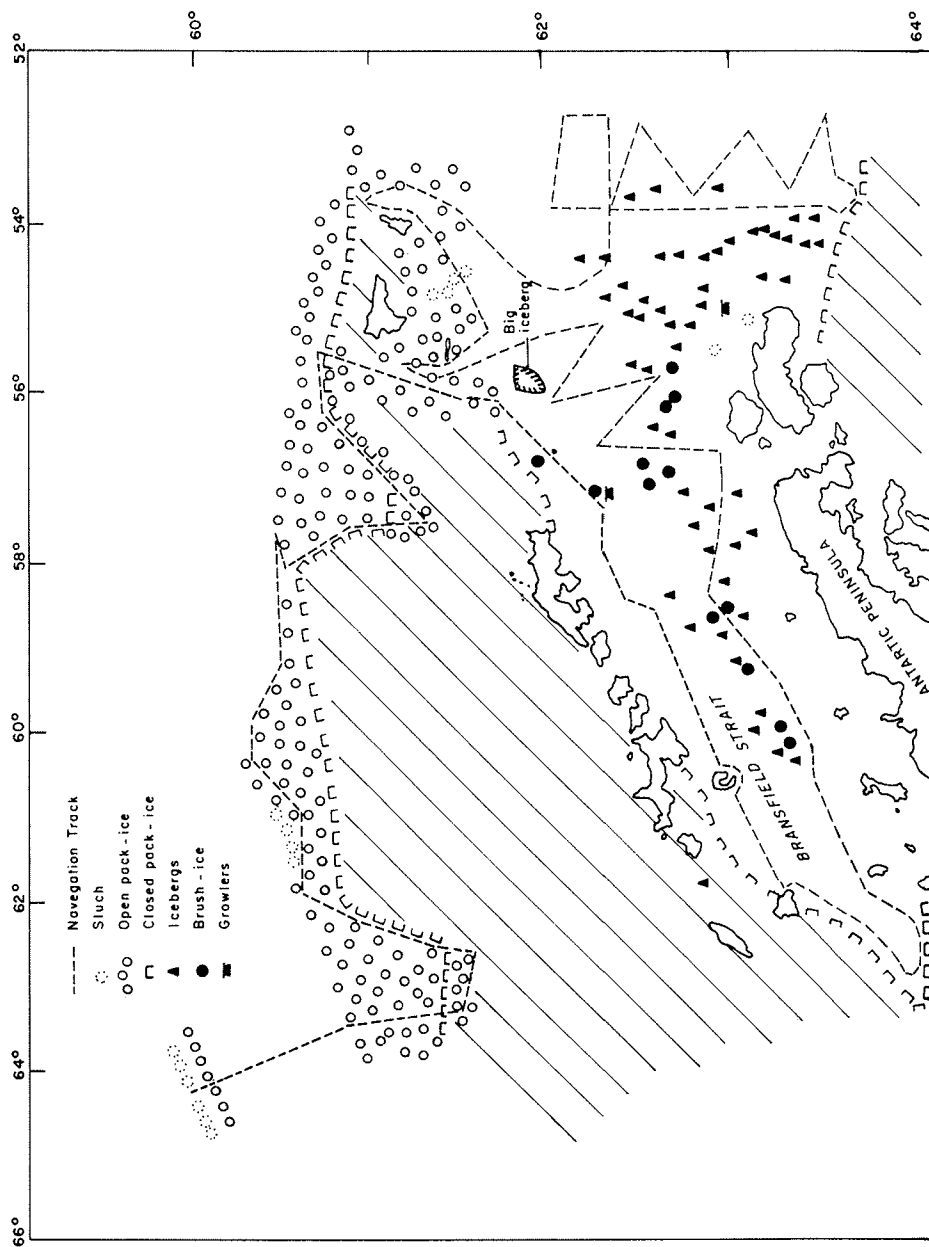

Fig. 5 Sea ice conditions found during the third Chilean expedition (Sep.-Oct. 1976).
Source: Nakanishi and Guzmán 1978.

within the Bransfield Strait in zones free of ice, their intestines being of a whitish colour, probably due to the ingestion of sediments.

In accordance to these results, the main conclusions that may be deduced in respect to the krill behavior are the following:

- a) Krill maintains an important biomass all along the year in the Bransfield Strait and tends to be distributed over the slope, corresponding to the Antarctic Peninsula and Elephant Island.
- b) Krill maintains its gregarious behavior all along the year forming swarms of high density.
- c) Under the pack-ice fields that surround the South Shetlands and Elephant Island during winter, high larvae densities (furcilia V to VI) and juvenile krill (< 15 mm) were found.

Discussion

Following these conclusions, the next question arising is, what kind of an ecological process supports the maintenance of such an important krill biomass in the Bransfield Strait during the whole year.

The first reasonable hypothesis, that up to a certain extent allows to explain this fact, is that at least the adult fraction of the krill population is capable of staying in those places where the environmental conditions are appropriate for its subsistence, overcoming the local currents by means of active swimming movements. This hypothesis is supported by the observations done by Kanda et al. (1982) of the Tokyo Fishery University. During the fifth Japanese krill expedition in December 1976, they followed the movements of super swarms on distances of 46.3 and 115.9 miles, detecting average krill swimming velocities of 0.26 to 0.29 knots,

reaching maxima of 3.6 knots in a mainly southward direction (Fig. 6 and 7). The authors consider these displacements a product of active swimming, because during this experience they could follow several icebergs, drifting towards northwest at a speed of 0.18 knots. During that period the wind was calm (Force 1-2 Beaufort), so they estimated that the iceberg movements were caused by marine currents. Finally the authors conclude that these krill swarm displacements towards the coast may be considered as spawning migrations.

This characteristic of swimming by means of active movements that the krill aggregations present, is also described by Witek et al. (1982), in one of the most specific publications that have been written on this subject. In it the authors also point out that there is enough evidence, to sustain that this species tends to form great concentrations in places with strong currents and turbulences (Fig. 8 and 9), which the specimens may easily perceive, by means of their spatial orientation that supports the formation of aggregations.

The krill submarine photographs obtained during the FIBEX survey by Guzmán et al. (1982) in dense aggregations, also sustain Witek's statements: in 80% of the 700 positive exposures obtained krill showed a well defined corporal orientation (Fig. 10) even in deeper waters.

In this respect it is also very significant, that krill continues to form aggregations of big sizes and high densities in winter and spring, in spite of the short solar-light lapse that characterizes the days of these periods of the year (Guzmán 1981).

To verify the hypothesis above stated about the permanence of an important biomass in the Bransfield Strait it will be necessary to determine the size at which krill reaches sufficient swimming capacity for independent movements to recruit or form aggregations. Considering the low swimming capacity of larvae and juveniles, there is no doubt that

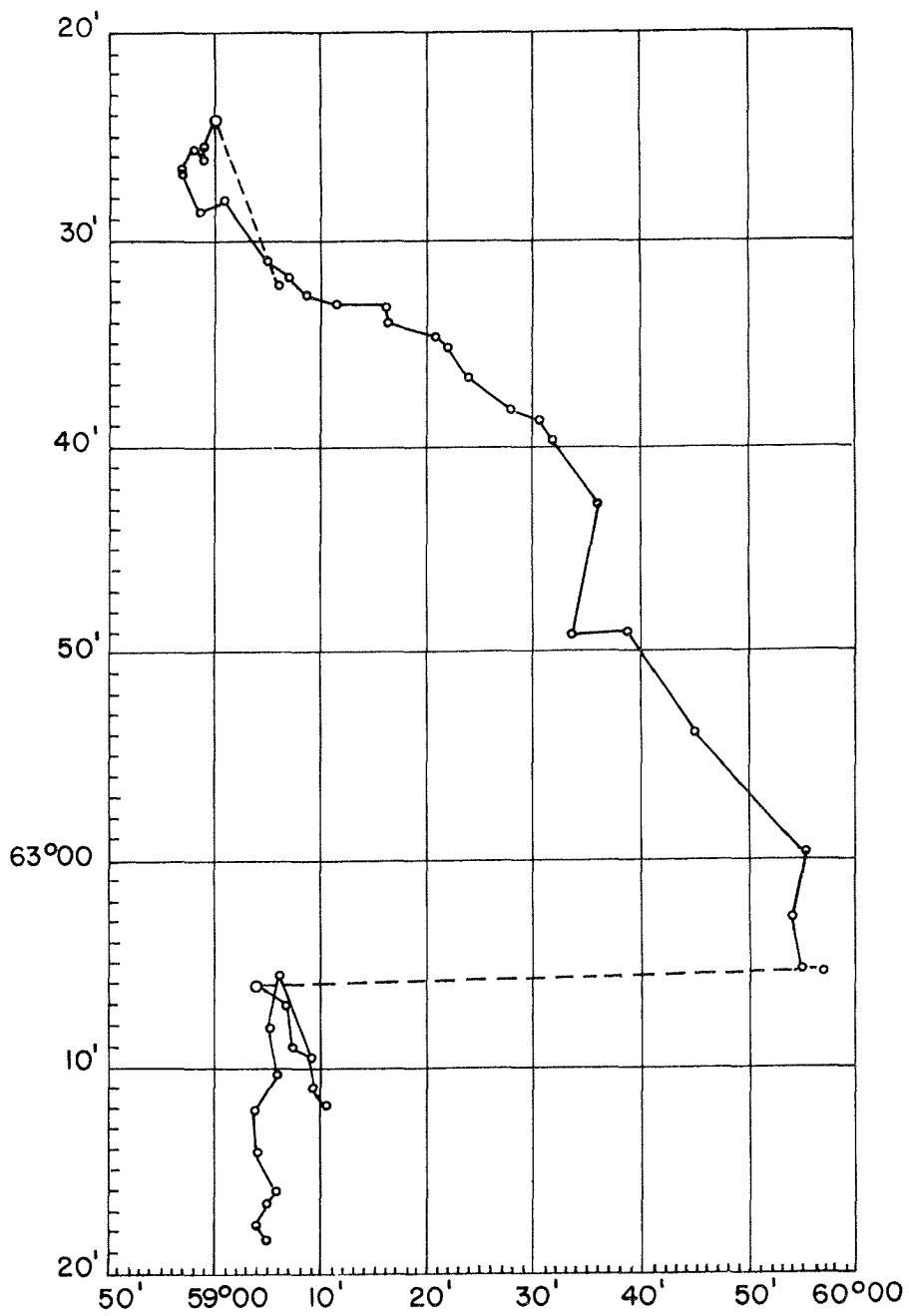

Fig. 6 Diagrammatical courses of the trawler Yoshino Maru following the movement of krill swarm No. 149, during the fifth Japanese expedition (Dec. 1976). Source: Kanda et al. 1982.

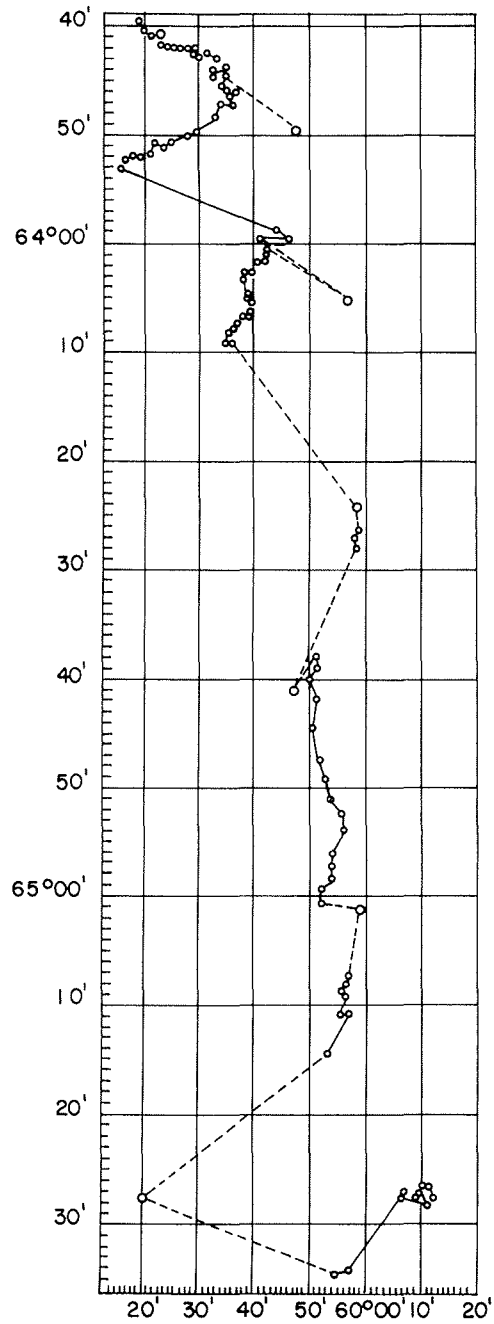

Fig. 7 Diagrammatical courses of the trawler Yoshino Maru following the movement of krill swarm No. 193, during the fifth Japanese expedition (Dec. 1976). Source: Kanda et al. 1982.

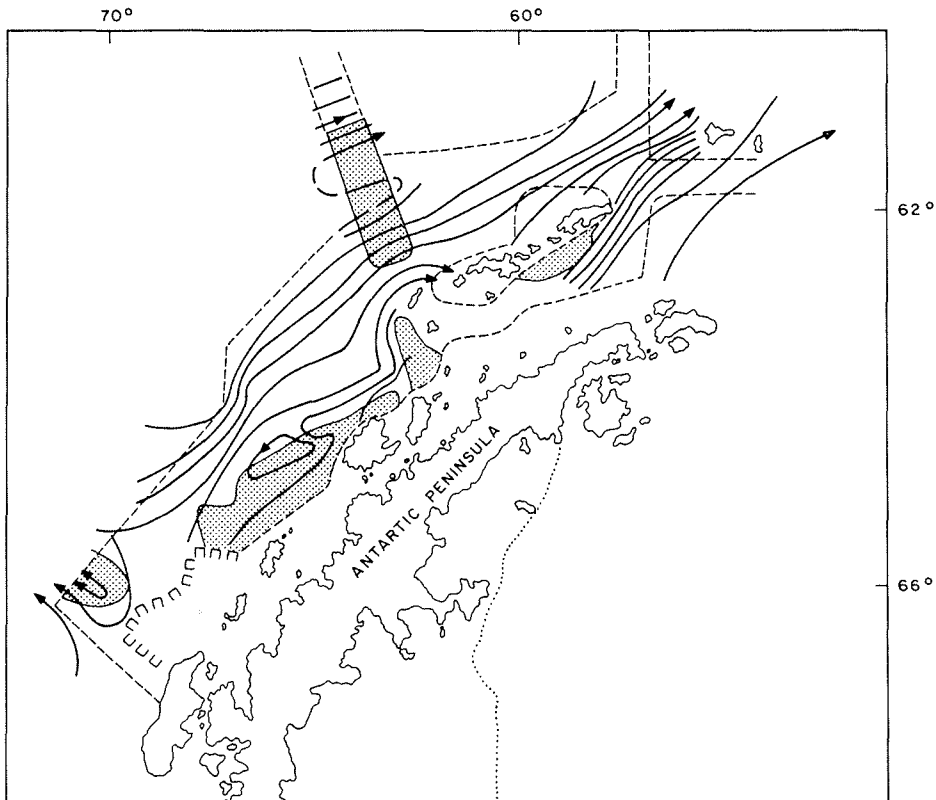

Fig. 8 Sea surface dynamic topography (rel. 500 dB) and areas of krill densities over 100 ton/nmile² (Feb. 1977). Source: Witek et al. 1982.

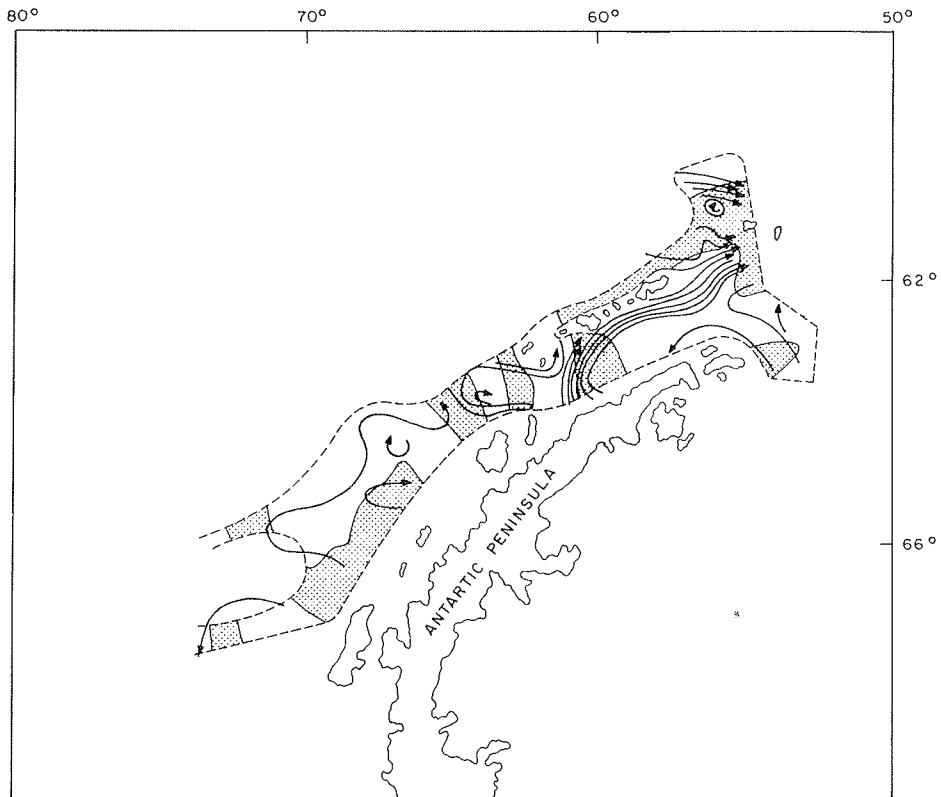
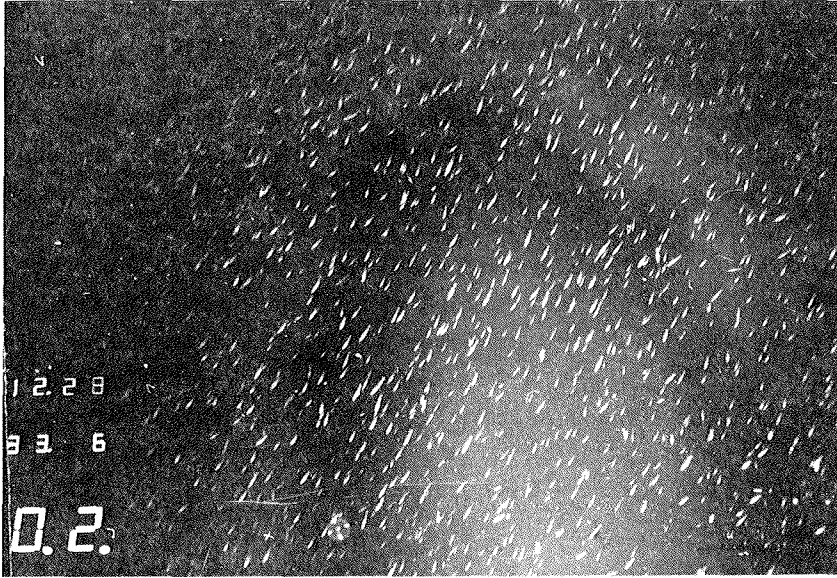
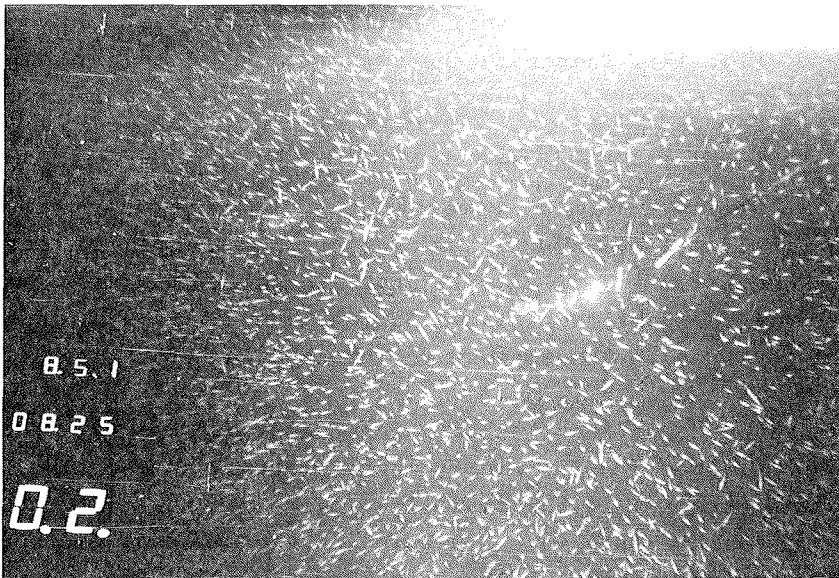

Fig. 9 Sea surface dynamic topography (rel. 500 dB) and areas of krill densities over 100 ton/nm² (Jan.-Feb. 1979).
Source: Witek et al. 1982.



Krill swimming horizontally



Krill swimming upward

Fig. 10 Krill (*Euphausia superba*) underwater photographs obtained during the Chilean FIBEX survey (Feb. 1981). Source: Guzmán et al. 1982.

external conditions may influence the recruitment process, such as currents or the pack-ice action. However, if the krill larvae distribution only depended on currents, especially considering the Antarctic Peninsula area with its generally northwesterly currents, it would be very difficult to explain the abundance of juvenile krill found near the coast.

During the Polish survey carried out in summer 1977, Witek et al. (1982) reported that they found basically juvenile and adolescent krill in the Bransfield Strait and in the region of the Antarctic Peninsula platform, located between Adelaide Island and the Palmer Archipelago. The same scientist detected a very similar situation again in summer 1978, when the fourth Polish survey took place (Witek 1979), which can be seen in Fig. 11.

Finally, the results given by Nast (1982), corresponding to the FIBEX survey done by the Federal Republic of Germany, also shows the presence of juvenile krill in the east of Joinville Island (Fig. 12). Therefore the reiteration of this behavior in several succeeding years, means that it is no incidental phenomenon.

Now it is important to remember the observations from the third Chilean expedition about large amounts of larvae (furcilia) and juvenile krill under the solid pack-ice, which surrounds the Shetland Islands during September, a fact that might be important to support the hypothesis before stated.

There is no doubt that the pack-ice fields offer an excellent winter shelter for larvae from the previous summer. They may remain stationary in the stability layer that the ice produces in the intermediate water, grazing on the abundant microorganisms that grow in its lower part (Deacon 1982). Later on, at the beginning of spring when the ice starts to recede towards the south, it will withdraw the juvenile specimens that in the following summer could easily recruit the adult populations located in optimum places for its development.

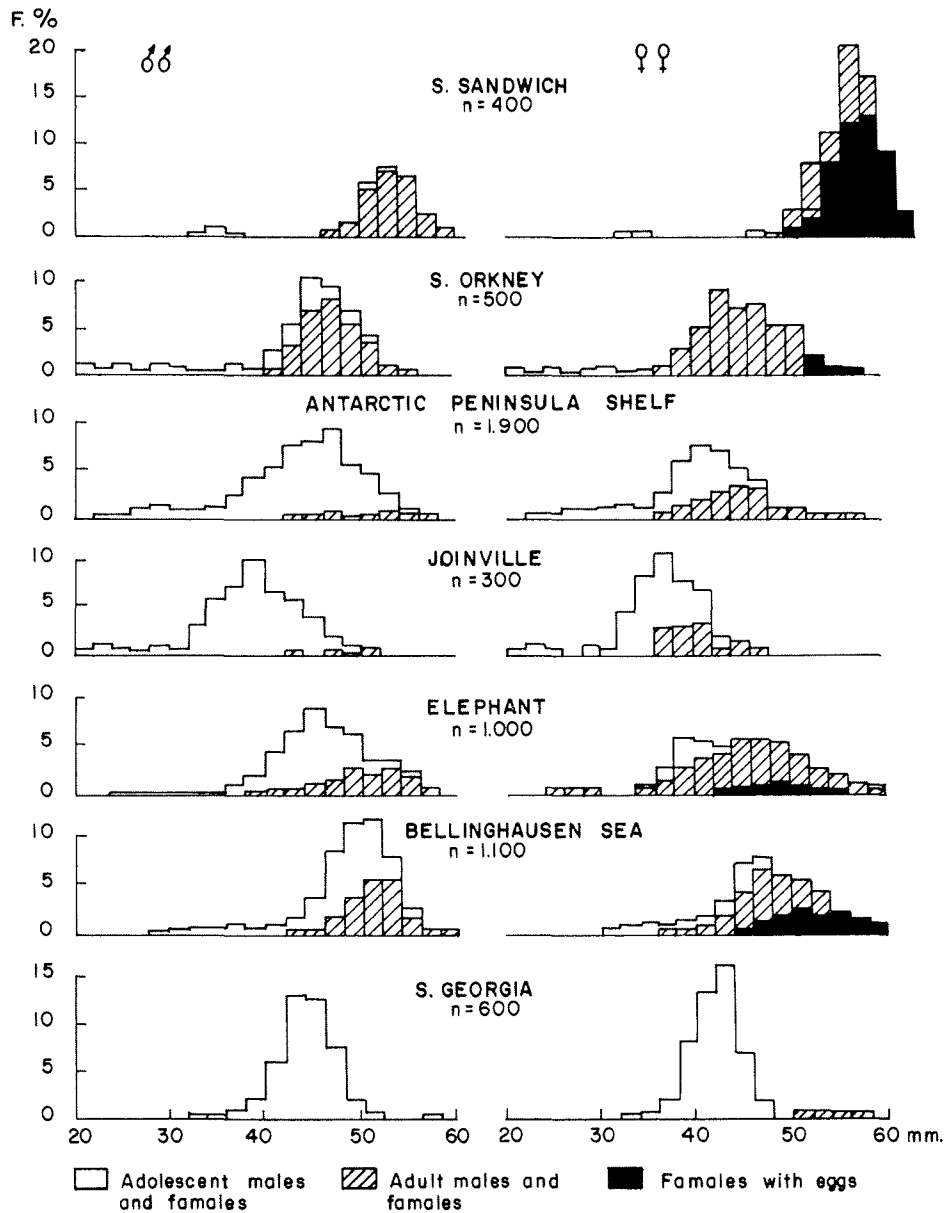

Fig. 11 Scope of krill length and maturity sampled in studied regions during the fourth Polish expedition (summer 1978-1979).
 Source: Witek 1979.

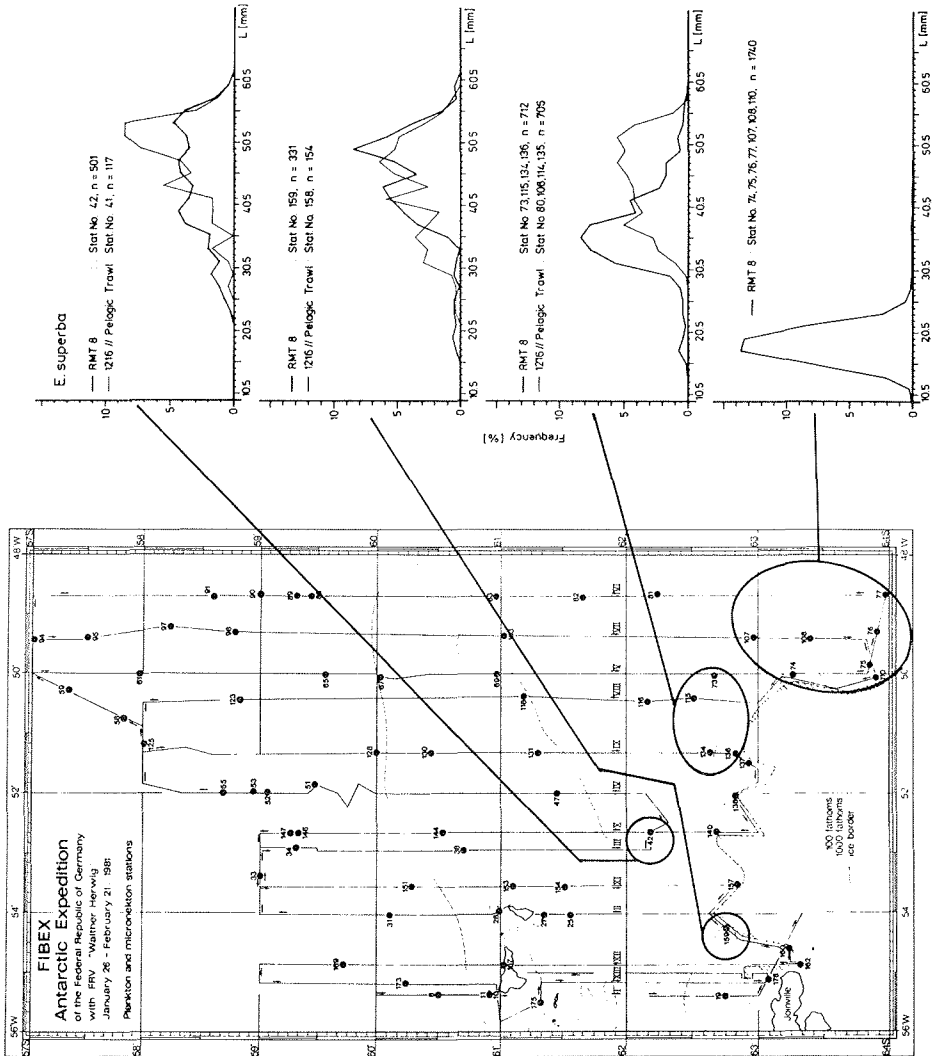

Fig. 12 Krill size distribution sampled by RMT 8 net and a pelagic trawl during the FIBEX expedition, carried out by the Federal Republic of Germany with FVR "Walther Herwig".
 Source: Nast 1982.

In the outlined behavioral pattern, the larvae that have the best opportunities of being protected and retained by winter ice, will be those from adult aggregations located in the south, because of their late arrival at lower latitudes. Also, according to Witek (1981), those aggregations spawn later.

Summarizing, the principal factors hypothetically supporting the existence and maintenance of such a large krill biomass in the surroundings of the Bransfield Strait are the prevailing marine currents in that area and the rise and reflux of pack-ice. If this hypothesis about the ice effect on the maintenance of krill abundance is correct, it is very probable that the krill biomass distributed within the Scotian Arch, comprises a population formed by local subpopulations.

Therefore, an eventual regulation tending to maintain the krill abundance, should be orientated to protect those "parental stocks". Especially towards the beginning of autumn until the end of spring when the older annual class of the population (III-IV), has died after their last reproduction cycle protection is necessary.

References

- Deacon GER (1982) Physical and biological zonation in the Southern Ocean. *Deep-Sea Res* 29:1-15
- Guzmán O (1981) Cuantificación del krill antártico (Euphausia superba) en el Estrecho de Bransfield mediante técnicas hidroacústicas AP/81/32 Instituto de Fomento Pesquero. Corporación de Fomento de la Producción
- Guzmán O, Lillo S, Marín B (1982) Calibration of the echointegration constant of krill (Euphausia superba). *INACH, Ser Cient* 28:57-86
- Guzmán O, Marín B (1982) Hydroacoustic and photographic techniques applied to study the behavior of krill (Euphausia superba). *Proceedings of the BIOMASS Colloquium, 1982. National Institute of Polar Res. Japan.* 129-152

- Hansen R, Madow W, Huwitz W (1953) Sample survey methods and theory. Vol. I and II. Methods and applications. John Wiley and Sons, Inc.
- Kanda K, Takagi K, Seki Y (1982) Movement of the larger swarms of Antarctic krill (Euphausia superba) population off Enderby Land during 1976-77 season. J Tokio Univ Fish 68:25-42
- Lillo S, Guzmán O (1982) Study of the abundance, distribution and behavior of krill at the Bransfield Strait and Drake Passage, by means of hydroacoustic techniques. INACH, Ser Cient 28:23-55
- Nakanishi A, Guzmán O (1978) Condiciones meteorológicas y de hielos. Segunda y tercera expedición antártica. Investigaciones biológico-pesqueras del krill. Instituto de Fomento Pesquero. Corporación de Fomento de la Producción
- Nast F (1982) The assessment of krill (Euphausia superba) biomass from net sampling programme. Arch Fisch Wiss 33:1-176
- Snedecor G, Cochran W (1967) Statistical methods. Iowa, USA. The Iowa State University Press. Arnes, 593pp
- Rojas O (1979) Antecedentes biológicos del krill (Euphausia superba). Instituto de Fomento Pesquero. Corporación de Fomento de la Producción
- Witek Z (1979) Phytoplankton distribution and some aspects of the biology of Antarctic krill (Euphausia superba). ICES CM 1979/L:14
- Witek Z (1981) On the life cycle of Antarctic krill (Euphausia superba). ICES CM 1981/L:20
- Witek Z, Grelowski A, Kalinowski J (1982) Formation of Antarctic krill concentrations in relation to hydrodynamic process and social behavior. ICES CM 1982/L:59

STUDY ON THE DIURNAL MIGRATION OF EUPHAUSIA SUPERBA
AND THE FORMATION OF SHOALS

by

Aldo P. Tomo

Abstract

This paper describes the methods employed in the study of the diurnal migration of Euphausia superba and the formation of shoals. The data were obtained during the First Biological Experiment (FIBEX) in the area "C" assigned to Argentina, by F.R.S. "Dr. Eduardo L. Holmberg" using hydroacoustic equipment - echosounder and echointegrator (Fig. 1 and 2). A computer was used to analyse the data. Visual observations were carried out in order to locate shoals which could not be detected with the hydroacoustic equipment because of the position of the transducer under the keel.

Investigations on the migration and formation of shoals were analysed using a complex system of graphs and statistical programs. This permitted the user to establish interactions between the various parameters.

Conclusions

1. Visual observations of shoals at the surface were found to be inadequate during the day, due to unfavourable meteorological conditions. Shoals several meters below the sea surface can, however, be detected by side scan sonar.
2. During the night krill shoals are easily observed by their luminescence, apart from being detectable by sonar. A closer scrutiny of the shoals showed that migration to the surface depended on the calmness of the sea and would probably also take place during the day.

3. The study of 268 shoals revealed that diurnal migration was as follows (Fig. 3): shoals were found to occur at depths from 20 to 50 m between 7:00 and 11:00 hours. Migration towards the surface was observed between 4:00 and 7:00 and 12:00 and 22:00 hours. No shoals were observed between 22:00 and 4:00 hours; this means that shoals were above the sonar range, between 0 and 5 m. On rare occasions shoals were observed at 100 m between 12:00 and 20:00 hours.

4. A correlation analysis of the factors:

1 Time

2 Depth

Shoal dimensions:

3 Vertical

4 Horizontal

5 Density

6 Abundance

A significant correlation was only found between density and horizontal dimension (0,57) and between density and abundance. The significance of these observations is discussed in a subsequent paper.

HOLMBERG '81 - TRANSECTOS -

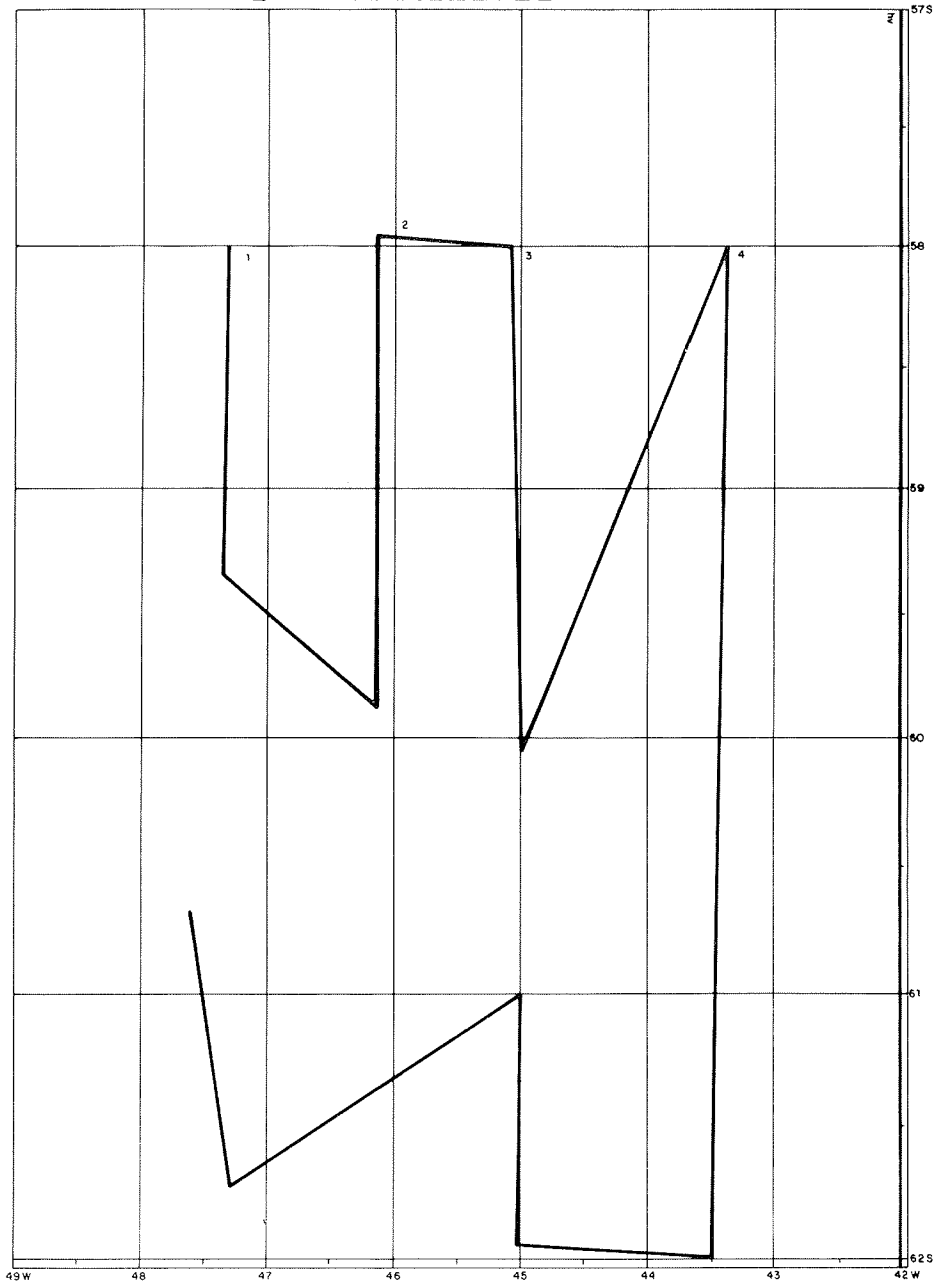

Fig. 1 First cruise of F.R.S. "Dr. Eduardo L. Holmberg".

HOLMBERG '81 -TRANSECTOS-

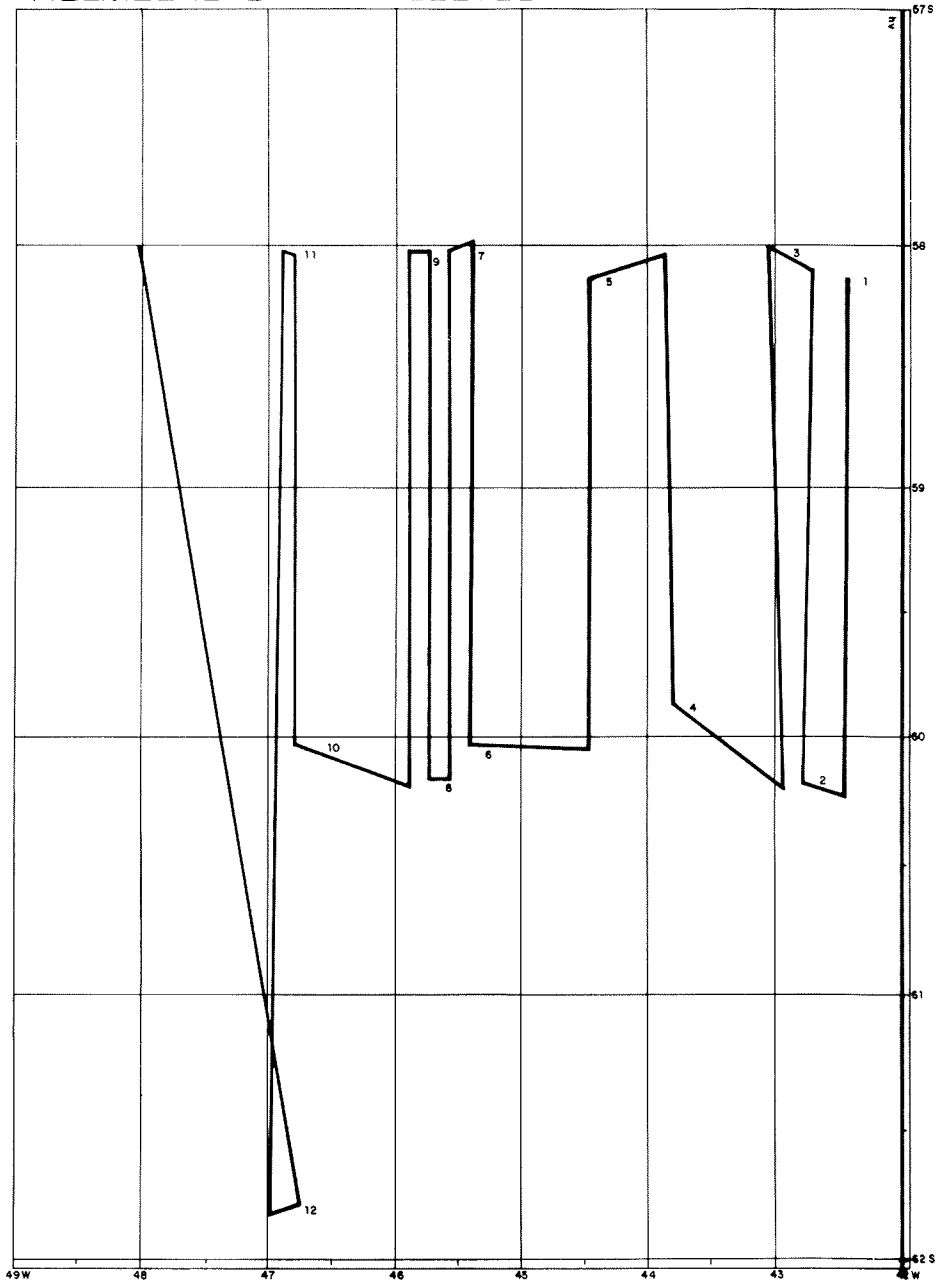
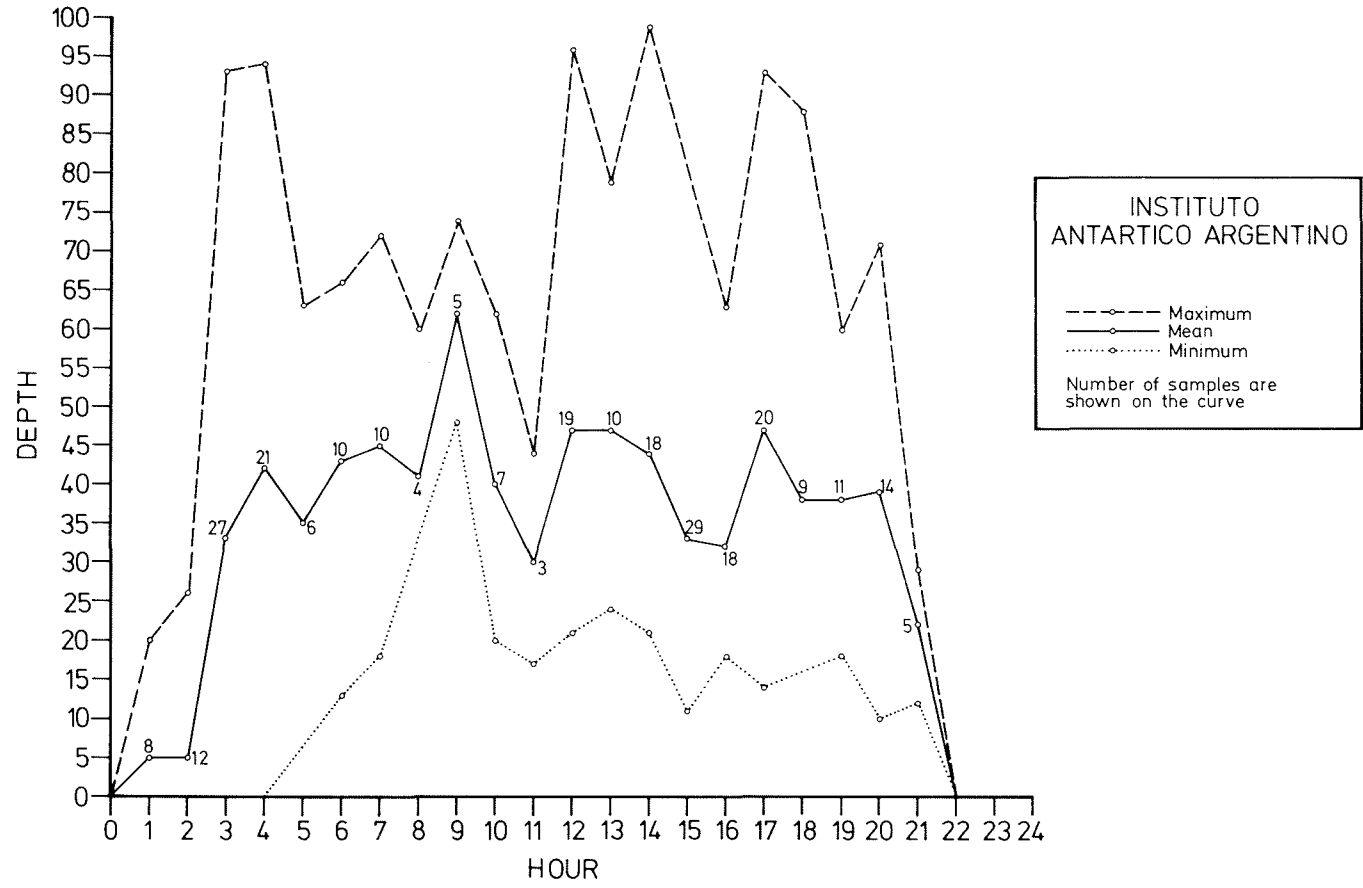

Fig. 2 Second cruise of F.R.S. "Dr. Eduardo L. Holmberg".

Fig. 3 Depth of swarms determined hourly intervals.



Depth of swarms determined hourly intervals.

OBSERVATIONS ON KRILL SHOAL LUMINESCENCE AT THE SEA SURFACE
AND THE ACCOMPANYING FAUNA

by
Aldo P. Tomo

Abstract

Observations of luminescing krill shoals and accompanying predators were carried out during night time cruises. The observations were made during the FIBEX programme on the FRS "Dr. Eduardo L. Holmberg" in the vicinity of the South Orkney Islands.

It was found that krill shoals were accompanied by Myctophid fish (Fig. 1). On the shoal peripheries, predation by Chaenichthyidae sp. of various sizes was observed. Petrels, (Daption capensis and Pchyptila sp.) appeared to be feeding on the surface. A large shoal of salpas interspersed with fish was seen underneath the krill shoal between approximately 20 and 40 m (Fig. 1).

The krill shoals near the surface resembled the Milky Way (Fig. 2).

Conclusions

1. It was fortunate that meteorological conditions permitted these observations to be made.
2. Myctophid fish accompanied the krill shoals and could be detected by their own luminescence.
3. Chaenichthyidae and Notothenidae, fishes with benthic-demersal habits rose to the surface to feed on the krill. Krill were observed to "jump" out of the water.
4. Birds, especially Petrels fed on the krill at the surface.
5. It could not be established whether the observed shoal of salps bore any relation to the krill shoal or whether their occurrence was a coincidence.

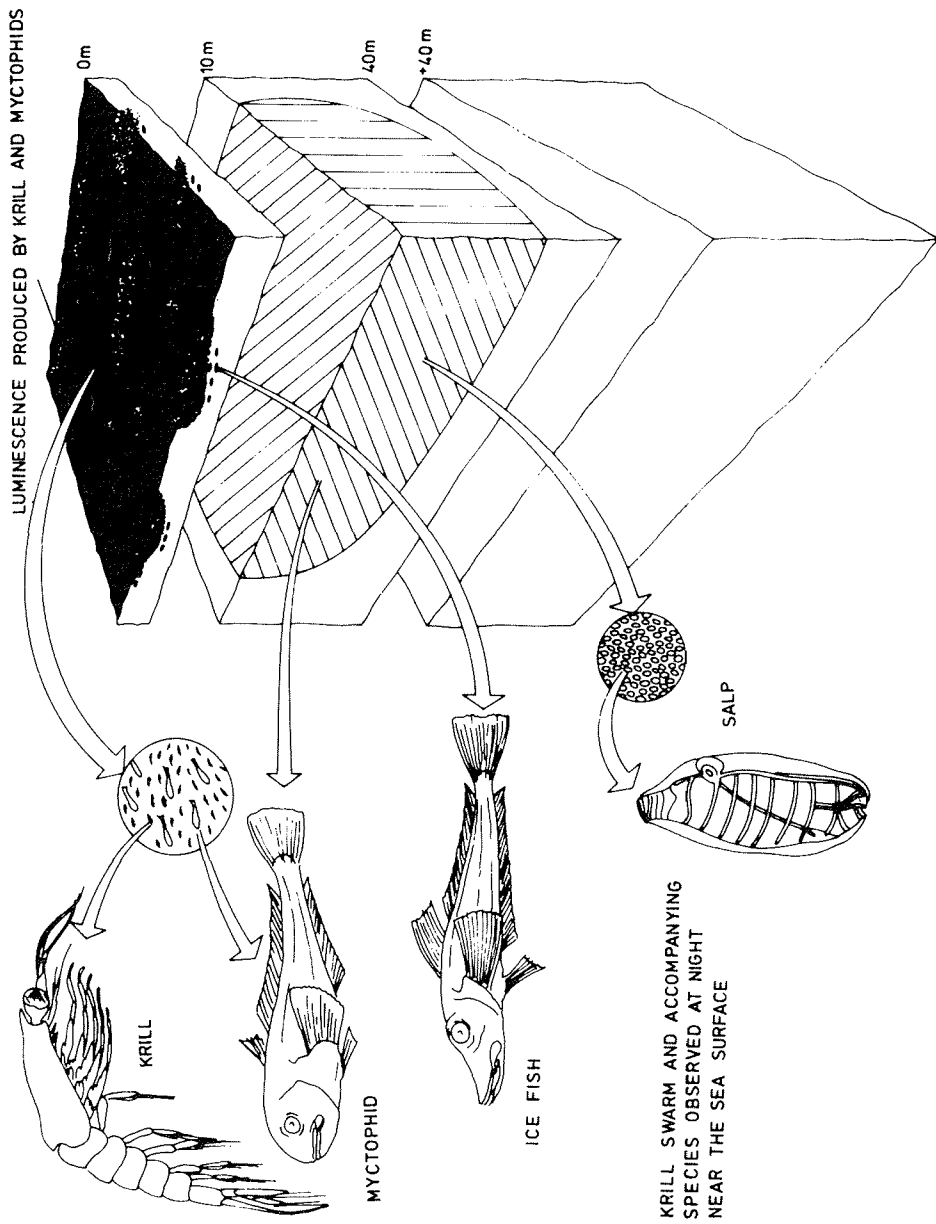
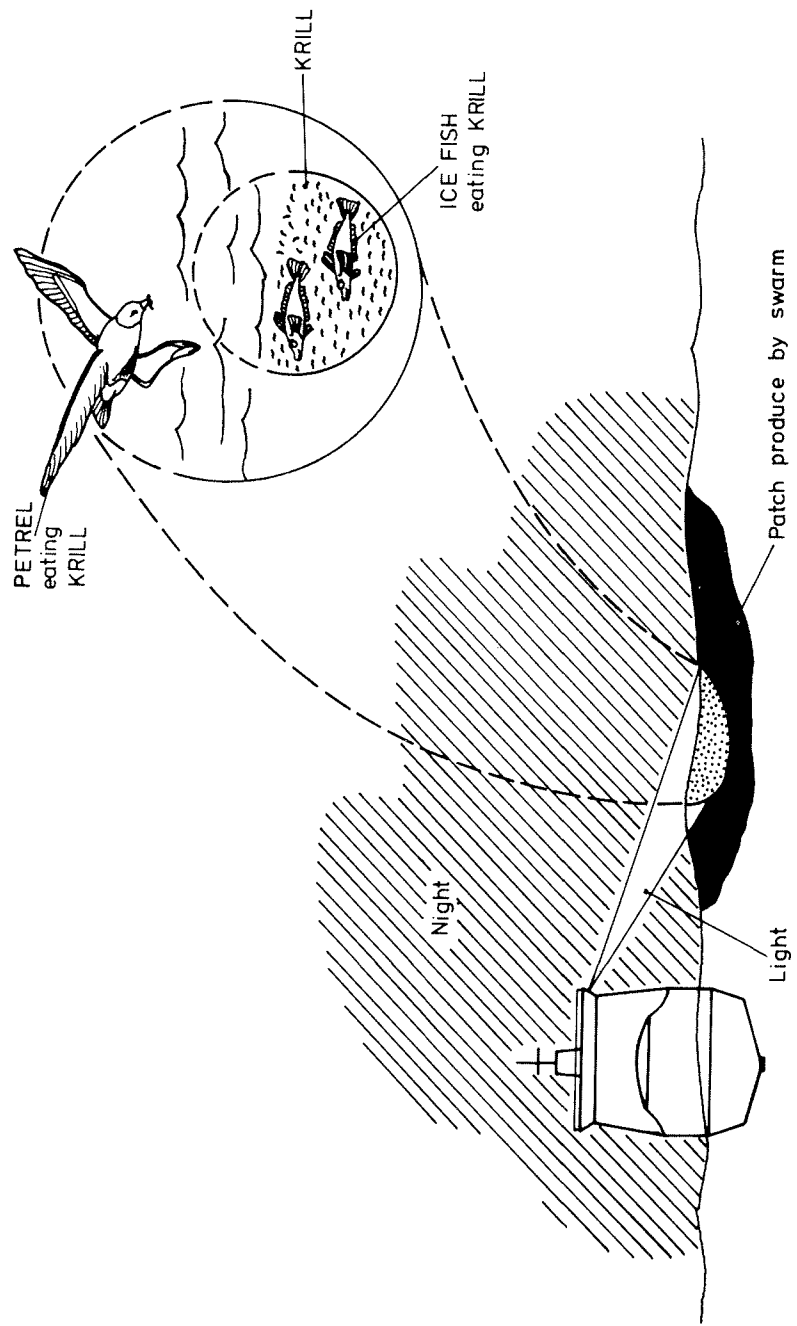

Fig. 1 Krill swarm and accompanying species observed at night near the sea surface.



Observation of Krill swarms at the sea surface using light beam.

Fig. 2 Observation of krill swarms at the sea surface using light beam.

AGGREGATION OF EUPHAUSIA SUPERBA AS AN ADAPTIVE
GROUP STRATEGY TO THE ANTARCTIC ECOSYSTEM

by

Tarsicio Antezana and K. Ray

Abstract

The following model is a series of working hypotheses addressing the role of krill feeding in the formation, maintenance, and dispersal of krill aggregations. Small foraging schools locate feeding grounds, and assemble into large scale aggregations, where feeding occurs in semi-stationary swarms until the depletion of food resources, whereupon disengagement of the swarm into small schools occurs, whose foraging is associated with horizontal migrations and vertical diel migration. The integration of krill schooling, swarming, and their diverse feeding displays and migratory behaviors beneath the framework of one overall feeding strategy is based on principles in behavioral and social ecology, field data by the authors suggesting the important role of feeding in large scale krill aggregations north of Elephant Island, and a bit of imagination. We present the model as a series of working hypotheses to aid in evaluating the adaptive significance of gregarious behavior of krill in general. Based on limited but provocative data, we foresee that these working hypotheses will undergo future modifications, and will stimulate discussion.

Introduction

An understanding of the processes underlying the formation and persistence of krill aggregations is essential for the management of stocks and the conservation of the Antarctic because krill aggregations define the sites of fishing grounds, major trophic interactions, and energy flow within this ecosystem.

Historically, snap-shot descriptions which have attempted to correlate krill aggregations* to physical regimes have not been very conclusive. Alternatively, the biological and behavioral processes involved in krill aggregations have received little attention, in spite of an accumulating literature concerning the importance of these factors (Anon. 1981, Bigidare et al. 1981, Antezana et al. 1982, Hamner et al. 1983), and the pervasive adaptive significance of group behavior (cf. Wilson 1978, Krebs and Davies 1979, Barash 1982).

Based on a broad literature review which demonstrates among others, certain adaptive advantages of feeding in groups, and recent data indicating the importance of feeding in the formation of large-scale krill aggregations (Antezana and Ray in press), we propose a model relating the gregarious mode of krill to the location and utilization of patchy food resources. We integrate diverse behavioral capacities of krill, aggregation types and sizes under one common framework as a logical exercise to aid in understanding how krill feeding could motivate the formation, maintenance, and dispersal of krill aggregations. The model is more properly a series of our working hypotheses (Antezana et al. 1982, Antezana and Ray in press) based on limited but provocative results, general principles in behavioral and social ecology, and also a bit of imagination.

Advantages of living in groups

Living in groups may confer numerous advantages to members with regard to reproduction, increased defense against predators, increased feeding efficiency, increased intra-specific competition, and conditioning the environment (cf.

* "aggregation" is used in a loose sense to define both the process of gathering, as well as a set of conspecific individuals which are gathered in the same place, displaying or not an internal structure, and remaining together for a period of time while engaged or not in cooperative behavior. The term includes groups like schools and swarms.

Wilson 1978, Krebs and Davies 1979, Barash 1982). But in spite of potential advantages, living in groups is often conditioned by a particular distribution and abundance of a limiting resource which permits individual requirements to be satisfied in group form. Among organisms of various phyla it is often the case that group strategies occur where limiting resources (e.g. food, refuge or nesting sites, predators) are highly patchy in space and unpredictable in time. For example, dispersed food sources tend to favor the evolution of solitary foragers, whereas food sources which are patchy in space and unpredictable in time tend to select for group feeding strategies (Horn 1968). Food is usually considered the crucial limiting resource in the highly advective, refugeless, patchy pelagic (Isaac 1969).

Optimal foraging theory predicts that foragers should search for and occupy patches of high food abundance (Pyke et al. 1977), and this prediction is borne out in marine systems. Pelagic schooling fishes such as herring converge onto large copepod patches to feed (Horwood and Cushing 1978). These authors reason that it is more economical for fish to feed on patches than on evenly distributed individuals. Likewise, copepods can be induced to aggregate with dense phytoplankton mixtures (Bainbridge 1949, 1953, fide Poulet and Quillet 1982), and both the aggregation and feeding of copepods can be mediated by amino acids presumably originating in the phytoplankton (Poulet and Quillet 1982).

Dynamics of feeding groups of Euphausia superba

Given the adaptive significance of gregarious life, the ability of marine pelagic organisms to actively converge on patches of their prey and feed gregariously, and the patchy nature of pelagic ecosystems (Steele 1976, Haury et al. 1978) including the Antarctic, a conceptual model is proposed. It describes the formation and persistence of krill aggregations when food and feeding are the principle factors motivating aggregation. Based on recent laboratory and field results, the

model is compatible with a growing literature which explores both the wide behavioral capacities of krill (Kils 1981, Antezana et al. 1982, Hamner et al. 1983) and the importance of krill feeding in the formation and persistence of large scale aggregations (Antezana and Ray in press). The purpose of the model is to generate testable predictions and hypotheses which can delimit the role of feeding in the formation and persistence of different scales and types of krill aggregations.

The following assumptions substantiate the model:

- 1) Krill are micronektonic animals with predominantly horizontal migration capacities, and capable of modifying their orientation to one another. This assumption is based on the conclusions of SCOR Working Group 52 (1980) that the schooling ability and high swimming velocities of krill incorporate them more appropriately within the "micronekton" than the "zooplankton"; in situ scuba observations (Hamner et al. 1983); and laboratory observations by authors.
- 2) Krill utilize different behavioral strategies to either locate or utilize food resources according to local food conditions, and these behavioral changes are reflected in changes in the size of aggregations, their densities, orientation, swimming and feeding. This second assumption is supported by the versatile and complex feeding behaviors described by Antezana et al. (1982) and confirmed by Hamner et al. (1983), and scuba observations on Euphausia superba by the latter authors.

The description of the internal organization and dynamics of feeding groups of E. superba is divided into the following phases: Formation, Maintenance and Dispersal (Fig. 1).

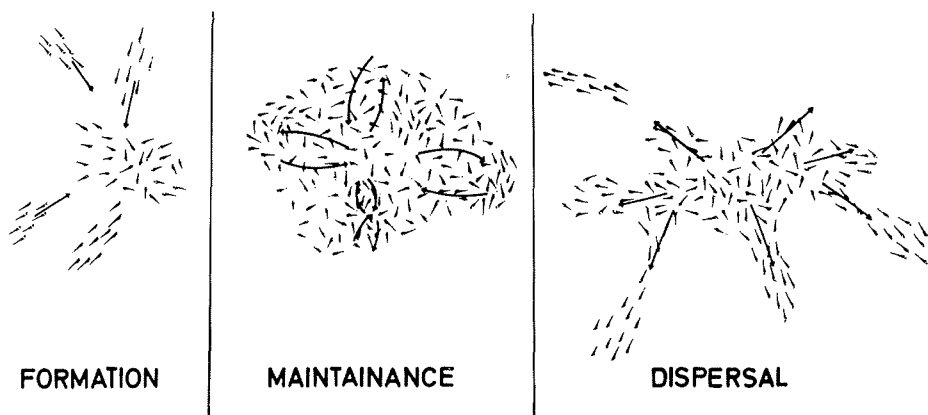

Fig. 1 Dynamics of feeding aggregations of E. superba.

Formation: 1) Detection and encounter of feeding grounds by small schools or solitary individuals; and 2) Horizontal migration and assemblage of large feeding groups. Maintenance: 1) Feeding in large semi-stationary swarms until the depletion of resources. Individuals are randomly oriented and moving to and from the periphery. Dispersal: 1) Disbandment of large feeding swarms into small foraging schools composed of individuals with parallel orientation and unidirectional motion; and 2) foraging is associated with horizontal and vertical diel migrations until the encounter of new feeding grounds.

Formation

Detection and encounter of suitable feeding grounds by small schools or solitary individuals. Horizontal migration and assemblage of large feeding groups.

A general pattern among certain terrestrial foragers is that they "meander" until prey is encountered, whereupon they greatly increase the rate of turning, thereby tending to remain in the vicinity of encountered prey (Pyke et al. 1977). This pattern is neatly described for feeding groups in an aquatic ecosystem (Test and McCann 1976), and be equally applicable to Antarctic krill. Given the high swimming velocities of krill (Kils 1979, 1981, Kanda et al. 1982), it is feasible that krill travel considerable distances assessing their habitat and modifying their distribution accordingly, within the limits of the current systems on which they are encountered.

Based on these evidences, we propose that 1) solitary krill or small foraging schools will gradually and actively accumulate into rich food areas; and 2) once krill converge here, they will not disperse widely to feed, but will form large feeding aggregations. This proposition is not unlike the behaviors described for aggregations of feeding fishes and dolphins (Radakov 1973, Pillery and Knuckey 1969, fide Wilson 1978).

We may tentatively propose that small schools are primarily searching groups which actively seek out rich food areas. This proposition is supported by several lines of evidence: aggregations of copepods have been chemically induced with specific amino acids, which are presumably phytoplankton exudates (Poulet and Quellet 1982); elevated swimming velocities of *E. superba* in the laboratory (Kils 1981) and in the sea (Kanda et al. 1982) yield several kilometers cruised per day; a tendency of form tight, unidirectional schools of parallelly orientated individuals (George and Denys, pers. comm.) with notable horizontal migration capacities (Hamner et

al. 1983); and the observation that dispersed adult krill with depressed stomach contents in the western Scotia Sea in late January, 1981 (Antezana and Ray in press) had apparently migrated out of the area to slope waters by mid March, 1981 (Brinton and Antezana in press).

Once solitary krill or small schools accumulate into a feeding ground, closely packed individuals will act as a physical filter grazing down a parcel of water to much lower concentrations than otherwise possible. This group strategy would be particularly efficient for krill to graze down dense and ephemeral phytoplankton patches, and to postpone searching for new pastures until extreme depletion of the food source. Swarms could become stationary. Extensive, loose and semi-stationary aggregations have been described north of Elephant Island (Macaulay et al. in press). They seemed in fact separated by any series of intermediate sizes, densities and shapes (from Macaulay's echotraces).

Pavlov (1969) reported instead that krill dispersed to feed and swarmed only upon repletion. His results have not been supported recently in the laboratory (Antezana et al. 1982) nor in the field (Antezana and Ray in press). These authors showed that krill at aggregation densities similar to those encountered acoustically in large scale aggregations (ca. 2000-5000 ind/m³) in the field fed at elevated rates in the laboratory and presented elevated stomach contents and rapid egestion rates in swarms in the field.

Maintenance

Feeding in large scale aggregations until the depletion of resources

The formation of large scale aggregations within feeding grounds could satisfy either anti-predation, reproductive or feeding needs. For this reason it is necessary to explore the bases of the proposed filter effect of feeding aggregations

before examining how semi-stationary aggregations may be maintained and what effects this may have on the duration of the aggregation.

We propose that large scale aggregations of krill are principally feeding swarms, whose duration will be limited by local food resources.

The physical filter effect has been demonstrated in the laboratory by Poulet (1978, his Fig. 10) where aggregation alone increased food yield and resulted in the depletion of phytoplankton, independently of feeding rate, when the density of copepod consumers in a given volume was increased. A similar approach was used by Cody (1971) who neatly demonstrated how flocks of feeding finches made more efficient use of both renewable and non-renewable resources than dispersed feeders. Alternately, Cody suggested that scattered individuals would reduce resources gradually and evenly; and each spot would be visited an increasing number of times, reducing ambient food concentrations to levels not supporting maximal feeding efficiency and increasing the time spent searching for food rich areas. Tentative field support for the physical filter effect are the abrupt chlorophyll a gradients associated with krill population north of Elephant Island (Paden et al. 1981); notable differences in the chlorophyll a concentrations inside and outside of the large scale aggregation (Bigidare et al. 1981), and differences in phytoplankton species inside and outside a swarm (Holm-Hansen and Huntley in press).

Assemblage into large scale, semi-stationary aggregations requires that the parallel orientation, densities, and momentum of small schools give way to a looser, randomized, stationary mode. A centrifugal-centripetal movement may be performed by members who balance the benefits of feeding at the periphery, and the higher risks incurred there from elective predators. A large individual at the periphery would be exposed to phytoplankton levels permitting higher ingestion

rates (Antezana et al. 1982). This individual will be simultaneously exposed to "elective predators" (e.g. fishes, birds, cephalopods) as opposed to "mass predators" (e.g. whales), and therefore, by avoiding the periphery upon satiation, its probability of being eaten will decrease. Results suggesting intense peripheral predation on krill layers by gadoid fishes have been presented (Falk-Petersen and Hopkins 1981). On the other hand, an individual may tolerate conditions of lower food concentration temporarily by digesting more of the available nutrients from ingested food, a strategy shown by other gregarious animals (Steinwaser 1978), by decreasing food gathering motions (Antezana et al. 1982), and by various other means of saving energy (Test and McCann 1976). This expected tradeoff could result in a continuous centripetal-centrifugal exchange of individuals within schools as well as within aggregations, a feature that seemed to occur in large aquaria (Palmer Station) and in nature (scuba observations by Antezana on Euphausia vallentini? in Chilean fjords).

The stationary character of large feeding swarms also implies a short-term limitation of resources, which should delimit the duration of the event according to the magnitude of the aggregation and the levels of ambient food. This limitation of resources could force the disassociation of the swarm and its eventual relocation. Even where currents and local phytoplankton concentrations could renew resources (Paden et al. 1981), the depletion of resources and build up of metabolites occurred rapidly (Bigdare et al. 1981) in the 3-5 km x 8-12 km aggregation (Macaulay 1981) which actively fed (Antezana and Ray in press) north of Elephant Island. Apparently, this aggregation was a short-lived event whose formation, maintenance and dispersal lasted about four days (Macaulay et al. in press). Relocation of the aggregation was suggested by acoustic traces and notable changes in the distribution of a local fishing fleet (Brinton and Antezana in press, Macaulay et al. in press).

Dispersal

Disengagement of large feeding swarms into small schools whose foraging is associated with horizontal migration and vertical diel migration

If feeding is the principle factor motivating the formation and maintenance of krill aggregations, then the depletion of ambient food resources should initiate dispersal. Food could be considered "limiting" when ambient concentrations no longer supply the energy necessary to maintain the increased metabolic costs apparently incurred during active feeding, or at the in situ concentrations whereupon feeding stops. Some chlorophyll a concentrations within the swarm north of Elephant Island prior to dispersal were near $0.3 \mu\text{g/l}$ (Bigidare et al. 1981). Laboratory results of krill feeding at such low concentrations are not available. However, food levels in swarms can be affected by in situ processes affecting primary production and nutrient regeneration (Bigidare et al. 1981), as well as the advection of phytoplankton into the area (Paden et al. 1981, Holm-Hansen and Huntley in press). Therefore a swarm will disperse when grazing pressure exceeds both primary production and advection of phytoplankton. The lack of satiation should preclude the centripetal tendency of krill to avoid predation at the periphery. The centrifugal force of hungry krill seeking to overtake the periphery will prevail and will lead to the disbandment of the swarm. At this stage, differential swimming capacities of swarm members could feasibly fractionate the swarm into schools of characteristic size, sex or physiological state. We foresee these schools as being small, dense, unidirectional and formed by individuals maintaining parallel orientation, as those observed at sea (Hamner et al. 1983). The energetic and hydrodynamic considerations usually applied to schooling fish may be equally applicable to these krill schools. They are supposed to be essentially foraging, rather than feeding, groups whose high velocities are not apparently compatible with raptorial feeding behaviours (Hamner et al. 1983). However, lack of

lipid storage (Bottino 1974) suggests that E. superba should not go long without food. Consequently, the near absence of krill with empty stomachs in the field suggests that another mode of feeding, like filter feeding, may prevail in foraging schools.

The vertical diel migration should be an effective method to assess both vertical and horizontal variations in food concentration. This behavior, alternated with periods of feeding at the surface, may characterize foraging schools of krill until the location of feeding grounds which could induce and maintain large feeding swarms. The modification of the diel migration by local feeding conditions could explain the erratic nature of the vertical diel migration of adult krill. Day-time swarming at depth, and night-time dispersal near the surface have been described (Hardy and Gunther 1935, Marr 1962, Pavlov 1969, Kalinowski 1978, Everson 1982) as well as stationary swarms at a particular depth or at the surface in day-time (Hardy and Gunther 1935, Hampton 1980, Marr 1962). Therefore, a clear, consistent trend has not been established.

Discussion

One of the limitations of the model is derived from our current inability to classify "optimal feeding grounds" with regard to primary production rates, standing stocks, phytoplankton species composition, or geographical region. The current evaluation of krill feeding behavior does not substantiate such a definition, although it is clear that areas supporting high primary production will be necessary to support large populations like the one encountered north of Elephant Island, if these populations are to be actively feeding. It is interesting that the distribution of coastal pelagic fisheries are generally governed by the productivities of different areas, and that large catches often result in the shallow seas of continental shelves where high nutrient levels and coastal production allow complicated, rich food webs (Horwood and Cushing 1978). The standing stocks of phytoplank-

ton are generally much higher on the continental shelf than in oceanic regions (1.0-4.0 $\mu\text{g chl a/l}$ versus 0.1-0.2 $\mu\text{g chl a/l}$, Holm-Hansen and Hewes, pers. comm.). The shelf area west of Elephant Island in particular is the largest shoal area in at least the Atlantic sector of the Antarctic (Brinton and Antezana in press). Consequently, shelf regions may represent preferred feeding habitats for krill. In fact, the distribution of adult krill is often associated with shelf or slope regions (Kock and Stein 1977/78, Brinton and Antezana in press).

The microscale distribution of krill within these regions will probably be mediated by behavioral aspects of krill feeding. These include the ability to and efficiency of feeding upon large diatoms or nanoplankton; possible species-specific feeding preferences (or amino acid preferences, Poulet and Quellet 1982); and/or the ability of krill metabolites like ammonia and urea to increase in situ primary production rates on short time scales (Bigidare et al. 1981). These factors may determine the formation of feeding swarms, the persistence of highly migratory schools, or intermediate patterns.

Another limitation of the model is based on a fundamental assumption that the gregarious behavior of krill confers greater defense against its predators. This premise is supported by the difficulty of predators in locating patchy prey and the rapid satiations incurred by predators once patches are encountered (Brock and Riffenburgh 1960), and by distracting or confusing predators, and making the capture of prey more difficult (Neill and Cullen 1974, Radakov 1966, fide Falk-Petersen and Hopkins 1981, Milinski and Heller 1978, fide Cerri and Fraser 1983). This argument however does not hold for whales as "mass" predators. That the gregarious mode has evolved to decrease the predation pressure on krill may be valid only if predation by whales is lower than predation by all elective predators together. This is indeed true today, but improbable before whale fishery greatly depleted stocks.

If we can accept that predation on krill by the pristine whale stocks accounted more than 50% of all krill lost to predation, then we must apparently accept that the gregarious mode of E. superba is maladaptive. Even so, basic information regarding the specific feeding and biomasses of many elective predators such as cephalopods, fishes, many birds, seals and invertebrates are lacking. However, of numerous krill predators (Everson 1977) only some species of whales have specialized ability to feed on krill swarms. This suggests that the gregarious behavior was originally a response against elective predators; and that it is precisely this gregarious behavior the evolutionary force motivating of the unique morphological, physiological and ethological feeding adaptations of baleen whales, among the marine mammals, and newcomers to the Antarctic community.

The foregoing model points out two different types of krill aggregations: swarms and schools which may be distinguished according to unique features in their internal organization, individual behavior and overall dynamics. The utilization of behavioral and biological factors to define different aggregations fulfills for krill, by and large, the definition of a social species (Wilson 1978). One could argue that the classification of animal aggregations in general which display social behavior must be based on behavioral or biological criteria. Consequently, the use of labile parameters such as size, shape, density, etc. by themselves to classify aggregations may be less meaningful in an ecological sense than the use of the behavioral strategies which regulate aggregations. For this reason we may foresee the modification of the early classifications of krill aggregations proposed by Mauchline (1980) to include behavioral processes often used in the study of social organisms (Wilson 1978, Barash 1982).

Well aware of the many limitations of the present comprehensive model, we have attempted to generate a set of integrated working hypotheses for further analysis and eventual testing. In the light of the previous approaches used to study conta-

gious distribution of krill and krill swarming, and in view of SIBEX and of increasing interest in Antarctica we attempted a timely, fair exercise.

Acknowledgement

This work was supported by Grant No 20.37.08, Dirección de Investigación, Universidad de Concepción, Chile.

References

- Anonymous (1981) An evaluation of antarctic marine ecosystem research. National Academy Press. 99pp
- Antezana T, Ray K (in press) Active feeding of Euphausia superba in a swarm North of Elephant Island. J Crust Biol
- Antezana T, Ray K, Melo C (1982) Trophic behavior of Euphausia superba Dana in laboratory conditions. Polar Biol 1:77-82
- Barash DP (1982) Sociobiology and Behavior. Elsevier Science Publishing Co, Inc USA. 426pp
- Bigdare RR, Johnson MA, Guffy JD, Biggs DC (1981) Nutrient chemistry of ammonium in Antarctic surface waters. US Ant Journal XVI:168-170
- Bottino NR (1974) Fatty acids of Antarctic phytoplankton and euphausiids. Fatty acid exchange among trophic levels of the Ross Sea. Mar Biol 27:197-204
- Brinton E, Antezana T (in press) Distribution and characteristics of krill (Euphausia superba) populations in Scotia Sea and South Shetland areas during January-March 1981. J Crust Biol
- Brock VE, Riffenburgh, RH (1960) Fish schooling a possible factor in reducing predation. J Cons Perm Int Exp Mer 25:307-317
- Cerri RD, Fraser DF (1983) Predation and risk in foraging minnows: balancing conflicting demands. Am Nat 121:552-561
- Cody ML (1971) Finch flocks in the Mohave Desert. Theoretical Pop Biol 2:142-158
- Everson I (1977) The living resources of the Southern Ocean. Southern Ocean Fisheries Survey Programme GLO/SO/77/1, FQO, UNDP, Rome. 156pp

- Everson I (1982) Diurnal variations in mean volume back-scattering strength of an Antarctic krill (Euphausia superba) patch. J Plankton Res 4:155-162
- Falk-Petersen S, Hopkins CC (1981) Zooplankton sound scattering layers in north Norwegian fjords: Interactions between fish and krill shoals in a winter situation in Ullsfjorden and Øksfjorden. Kieler Meeresforsch, Sonderh 5:191-201
- Hamner WH, Hamner PP, Strand SW, Gilmer RW (1983) Behavior of Antarctic krill, Euphausia superba: chemoreception, feeding, schooling, and moulting. Science 220:433-435
- Hampton I (1980) Cruise Report S.A. Agulhas Voyage 12, 28th February-2nd April 1980. Inst Rep Sea Fish Inst Cape Town. 34pp
- Hardy AC, Gunther ER (1935) The plankton of the South Georgia whaling grounds and adjacent waters, 1926-1927. Discovery Rep 11:1-456
- Haurly LR, McGowan JA, Wiebe PH (1978) Patterns and processes in the time-space scales of plankton distributions. In: Steele JH (ed) Spatial pattern in plankton communities. Plenum Press, New York. Nato Conference Series IV: Marine Sciences 3, pp 277-327
- Holm-Hansen O, Huntley M (in press) Feeding requirements of krill in relation to food sources. J Crust Biol
- Horn HS (1968) The adaptive significance of colonial nesting in Brewer's blackbird (Euphagus cyanocephalus). Ecology 49:682-694
- Horwood JW, Cushing DH (1978) Spatial distributions and ecology of pelagic fish. In: Steele JH (ed) Spatial pattern in plankton communities. Plenum Press, New York. Nato Conference Series IV: Marine Sciences 3, pp 355-383
- Isaac J (1969) The nature of oceanic life. Scient Amer 221:146-162
- Kalinowski J (1978) Vertical migration of krill in the region of South Georgia, February, March 1976. Pol Arch Hydrobiol 25:573-583
- Kanda K, Takagi K, Seki Y (1982) Movement of the larger swarms of Antarctic krill (Euphausia superba) population off Enderby Land during 1976/77 season. J Tokyo Univ Fish 68:25-42
- Kils U (1979) Swimming speed and escape capacity of Antarctic krill Euphausia superba. Meeresforsch 27:264-266

- Kils U (1981) The swimming behavior, swimming performance and energy balance of Antarctic krill, Euphausia superba. BIOMASS Sci Ser 3:1-122
- Kock KH, Stein M (1977/78) Krill and hydrographic conditions off the Antarctic Peninsula. Meeresforsch 26:79-95
- Krebs JR, Davies NB (1979) Behavioural ecology: an evolutionary approach. Blackwell Scientific Publications, Great Britain. 494pp
- Macaulay MC (1981) Distribution and abundance of krill in Scotia Sea as observed acoustically. US Ant Journal XVI:166-167
- Macaulay MC, English TS, Mathisen DA (in press) Characteristics of Antarctic krill (Euphausia superba) swarms from Elephant Island and Bransfield Strait. J Crust Biol
- Marr J (1962) The natural history and geography of the Antarctic krill (Euphausia superba Dana). Discovery Rep 32:33-464
- Mauchline J (1980) Studies on patches of krill, Euphausia superba Dana. BIOMASS Handbook 6:1-36
- Paden CA, Hewes CD, Neori A, Holm-Hansen O, Weaver E, Kiefer DA, Sakshaug E (1981) Phytoplankton studies in the Scotia Sea. US Ant Journal XVI:163-164
- Pavlov VYa (1969) The feeding of krill and some features of its behavior. Trudy VNIRO 66:207-222 (issued as MAFF Transl ns 94)
- Poulet SA (1978) Comparison between five coexisting species of marine copepods feeding on naturally occurring particulate matter. Limnol Oceanog 23:1126-1143
- Poulet SA, Quillet G (1982) The role of amino acids in the chemosensory swarming and feeding of marine copepods. J Plankton Res 4:341-361
- Pyke GH, Pulliam HR, Charnov EL (1977) Optimal foraging: a selective review of theory and tests. Wart Rev Biol 52:137-154
- SCOR (1980) Recommendations from SCOR WG-52, WG Percy (Convenor) Symposium on Estimation of Micronekton Abundance. Idyllwild, California 28-30 April 1980. 15 pp (mimeo)
- Steele JH (1976) Patchiness. In: Cushing DM, Wilsh JJ (eds) The ecology of the seas. WB Saunders, Philadelphia, Chapter 5:98-115
- Steinwaser K (1978) Interference and exploitation competition among tadpoles of Rana utricularia. Ecology 59:1039-1046

Test FH, McCann RG (1976) Foraging behavior of Bufo americanus
tadpoles in response to high densities of microorganisms.
Copeia 576-578

Wilson EO (1978) Sociobiology. Harvard University Press USA.
697pp

Co-author's address: K. Ray
University of Concepcion
Concepcion
Chile

ON THE GEOGRAPHIC BOUNDARY OF ANTARCTIC KRILL DISTRIBUTION

by

Keiju Nasu

It is well known that the most important organism of the Antarctic Ocean Ecosystem is krill. This presentation is intended to refer for defining geographic limits for the data collection and compilation of information on the krill from the oceanographic environmental point of view.

According to the experimental fishing of krill by the Japan Marine Fishery Resource Research Center in 1975/76 and 1976/77 Antarctic season, the swarming composition of krill off Enderby Land is distinguishable as a layer or cloud of the type as seen in Fig. 1. Fig. 2 shows the distribution of water temperature at the layer of 50 m along with the catch per unit effort which is in this context the catch per net haul. It is clear that the krill fishing grounds are distributed in an area of about 30 miles North/South latitudinal zone and about 50 miles East/West. The krill are concentrated in an area of about 15 miles N/S and 25 miles E/W where a strong meandering isotherm and the cold and warm ring were observed. It must be considered that such a physical feature is one of the primary factor making a good concentrated area for krill. At the favourable krill fishing ground off Enderby Land, a strongly eastward flow meander is observed with a system of geostrophic currents consisting of alternating cyclonic and anticyclonic gyres (Khimitsa 1976).

Off Enderby Land a generalized and recurring pattern is discernible in which the northern limit of the concentrated krill area which naturally is the location of fishing operation corresponds with southern limit of the Warm Deep Water where the Antarctic Divergence occurs. Horizontal diffusion of the upwelled deep water in the production layer, there is not restricted as it flows northward. The southward flow, however,

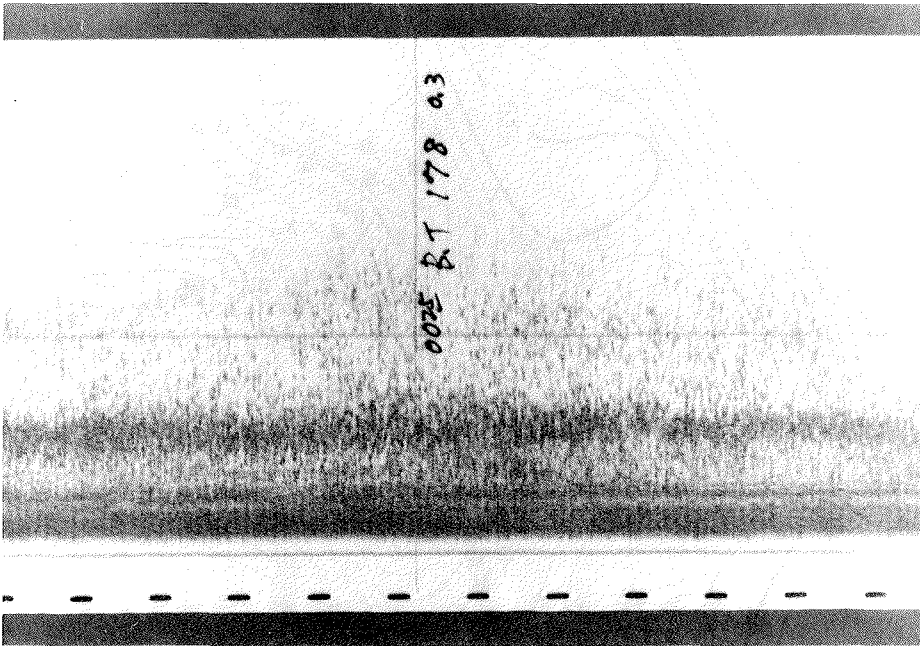

Fig. 1 Record of the fish finder.

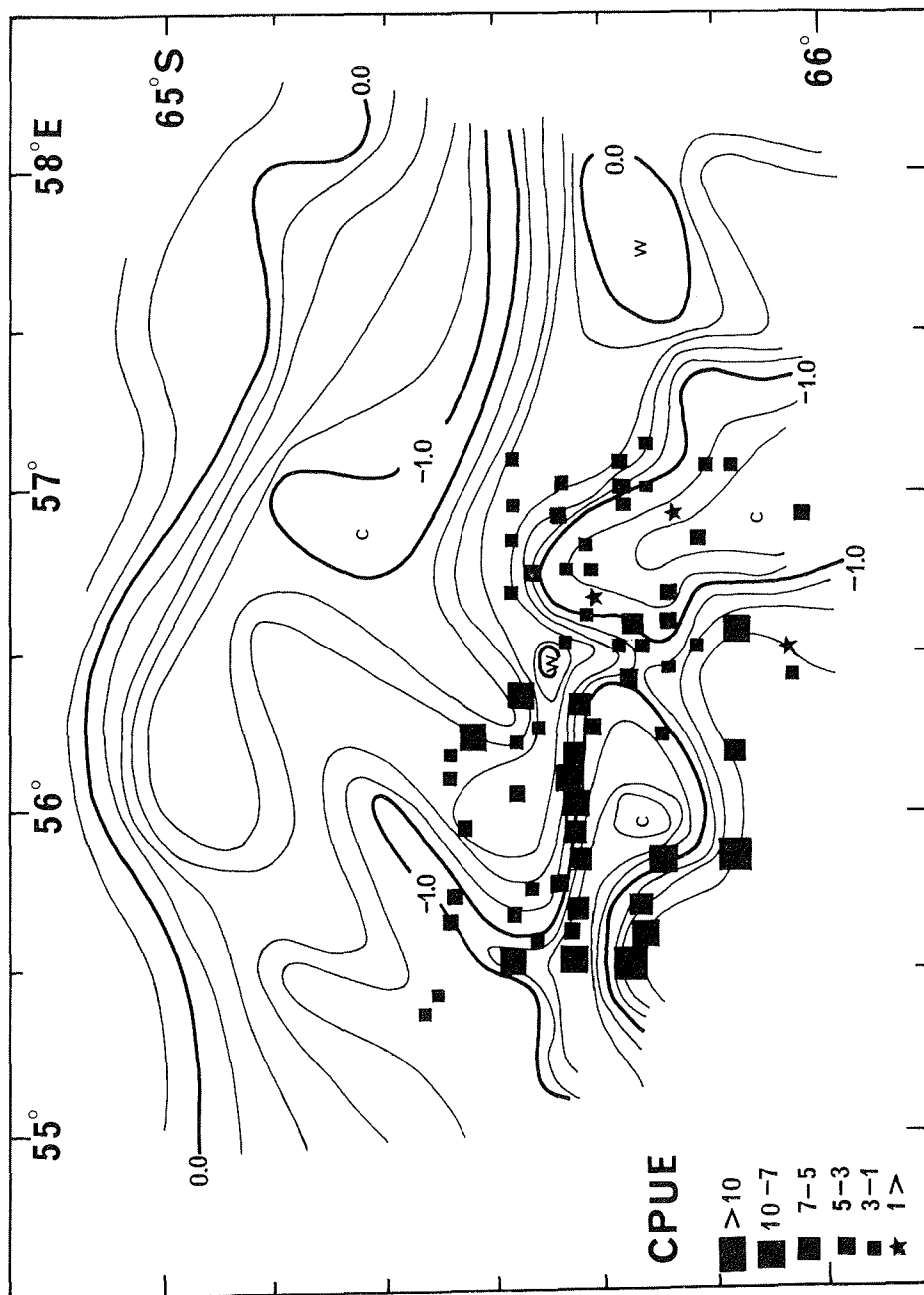

Fig. 2 The distribution of water temperature at the layer of 50 m and the catch per unit effort of krill off the Enderby Land.

is restricted due to the ice shelf and the Antarctic continent. Therefore nutrient salt brought to the surface in the deep water must be carried away towards the north to the north of the divergence, and must be accumulated in the south of that. The chemical composition of the seawater surrounding the Antarctic continent, as Hart (1942) has already reported will be greatly influenced by the materials which are carried in icebergs from the continent.

We would anticipate from this hypothesis that the nutrient salt concentration to the south of the Antarctic Divergence would be higher than that to the north. Voronina (1968) has also stated that the greatest breeding would be expected in the divergence zone. Therefore it seems that the area to the south of the Antarctic Divergence contains more favourable food conditions for krill when compared with the north.

In order to test this hypothesis, an oceanographic environment survey including the nutrient salt, primary production and krill biomass would need to be carried out in the Antarctic Divergence zone.

If the hypothesis is correct, it demonstrates that the accumulated krill area occurs in the East Wind Drift where the maximum krill biomass is observed in the meandering oceanic fronts and the cyclonic or anticyclonic circulation. These phenomena may be used to characterize the oceanographic environment of the major krill concentrations which thus become the focus of fishing operations in the East Wind Drift and the Weddell Drift. The major characteristics are as follows:

- 1) Meandering oceanic front and cyclonic or anticyclonic circulation to the south of the Antarctic Divergence
- 2) Northward flowing region in the East Wind Drift
- 3) Eastern edge of the Weddell Drift

Although krill have an ability to aggregate and move vertically they are effectively carried passively in a current, at least by comparison with fish. The movements of krill are unlikely to be on the same scale as those of fish. The krill concentrated area which occurs in a meandering current or oceanic front may therefore be shifted like a belt due to the velocity and path of current.

The velocity of the current in the area between 110 and 120 E was generally reported to be from 25 to 50 cm/sec. The fishing grounds had been in this area for about one month from the middle of January. It was assumed that the same group of krill was present on these fishing grounds and was moving at approximately 10 cm/sec, a speed corresponding to half to one fifth of the current velocity in this area. From the shifting velocity of the fishing ground, the occurring krill concentrated area must be influenced by cyclonic or anticyclonic circulation rather than a meandering current and oceanic front.

The krill fleet experimental fishing in 1977/78 Antarctic season was mostly carried out in the Antarctic Divergence where it was pointed out that many cold or warm rings have been occurring (see Fig. 3).

In recent publications, it has been observed that eddies occurred continuously in the open ocean with the radius approximately 100-200 km, and extended from the surface to deep layer. In the area where the influence of submarine topography is minimal, the oceanographic structure of krill fishing grounds has been consistent for a long period in approximately the same area. Compared with the whale catches, it seems that the krill fishing ground is located at a much lower latitude than that off Enderby Land whale fishing ground. However, such an area without a fixed element is different from the Enderby Land fishing ground which has

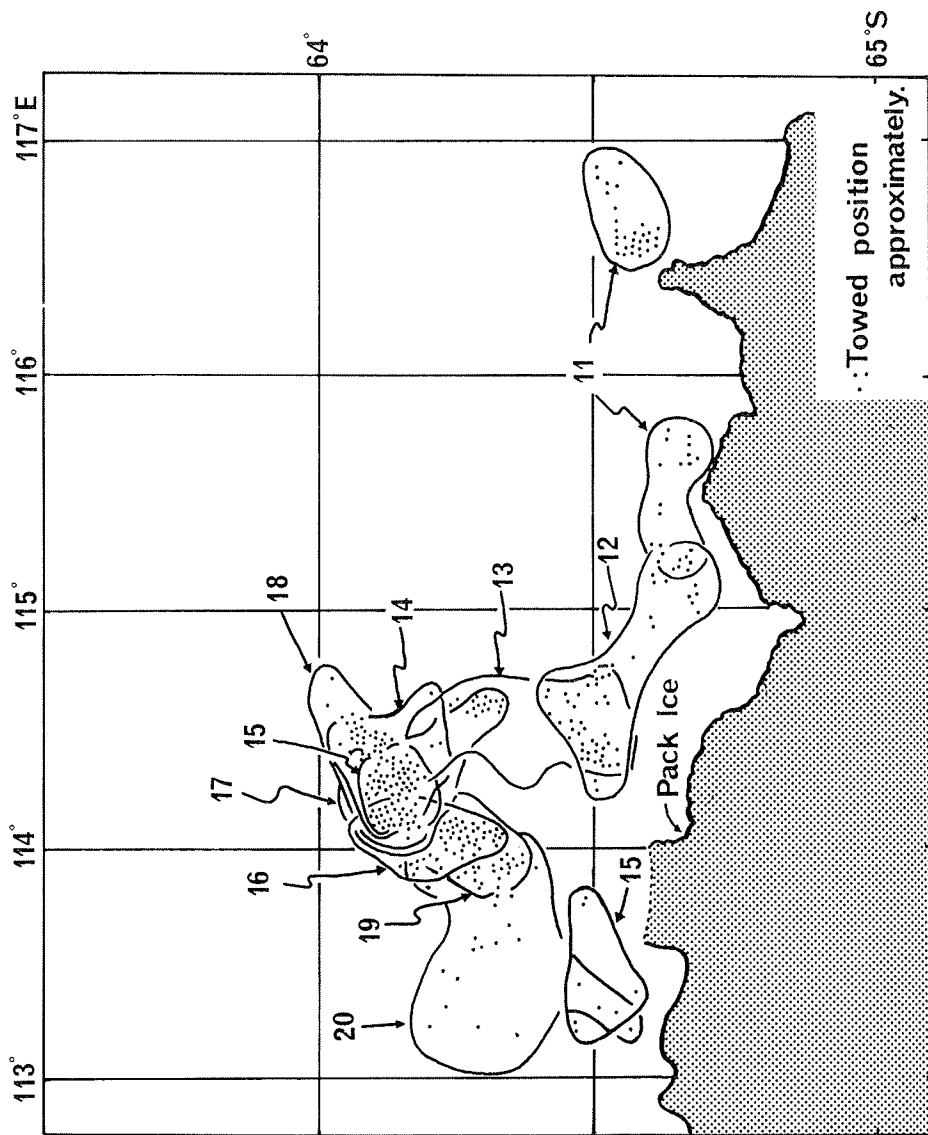

Fig. 3 Daily fishing ground by the krill fleet fishing operation in January of 1978. Numbers show date.

continental shelf. It must be considered that the fluctuation in space and time of the fishing ground without the fixed element is very great.

According to the distribution of krill catches obtained by the Japanese krill fishing operation in the seasons 1973/74 to 1977/78, it seems that the discontinuous zone in the distribution on krill became the centre of fishing operation between 70° and 75° E.

Through the materials on the horizontal distribution of temperature and the distribution of catch, the geographic boundary of Antarctic krill distribution should be taken account of the oceanographic environments.

References

Khimitsa VA (1976) Investigation of geostrophic currents in the Antarctic zone of the Indian Ocean. *Oceanology* 16:131-133

Hart TJ (1942) Phytoplankton periodicity in Antarctic surface water. *Discovery Rep* 21:261-356

Voronina NM (1968) The distribution of zooplankton in the Southern Ocean and its dependence on the circulation of water. *Sarsia* 34:277-264

Author's address: K. Nasu
Far Seas Fisheries Laboratory
Fisheries Agency
1000 Orido, Shimizu, Shizuoka 424
Japan

SOME ASPECTS OF DISTRIBUTION OF KRILL
ASSESSED BY LARGER PREDATORS

by
Takahisa Nemoto

Abstract

The Antarctic krill, Euphausia superba, is not only the main diet for the baleen whales but also for other larger predators including seals, fish, squid and sea birds.

The distribution of E. superba especially of its northern limit in the Southern Ocean is determined by the net sampling (Marr 1962) and stomach contents of baleen whales (Nemoto 1962). These ranges of distribution were similar and they may be used for the extrapolation of the biomass assessment by acoustic survey for limited area of survey.

As the general pattern, the smaller E. superba is distributing along the pack ice region in summer and fed by blue whales. On the other hand, fin whales come later to the Antarctic and feed on larger krill in the off waters. This also coincide with the fact that smaller krill have been often found under the ice.

According to the Japanese data accumulated through the Antarctic whaling, the large krill is observed in the Weddell drift and medium size krill is dominant in the high latitudes of Indian Ocean in the East Wind Drift and the smaller krill including Thysanoessa macrura is also dominant in the West Wind Drift in the Pacific region.

The Japanese pilot krill fisheries revealed that vertical distribution of E. superba varied seasonally, shallower in March and deeper in December and January. The density of E. superba in swarms varied up to 15 kg/m³ but the most part of

swarms are within the density of 100-200 g/m³. The concentration of individuals also varies within the short time (4-5 hours). The density also becomes heavier from December to March.

Cephalopods and fish also mostly fed on krill E. superba. The size of these fed E. superba is comparatively large, and there is few occurrence of furcilia and early juveniles. Squid are feeding on E. superba in the shallow waters above 100 metre, but fish took E. superba also in the deeper layers down to 400 metre.

References

- Marr J (1962) The natural history and geography of the Antarctic krill (Euphausia superba Dana). Discovery Rep 32:33-464
- Nemoto T (1962) Food of baleen whales collected in recent Japanese Antarctic expeditions. Sci Rep Whales Res Inst 16:89-103

MICRO-SCALE STRUCTURE OF WATER MASSES AND BOTTOM
TOPOGRAPHY AS THE BASIS FOR KRILL DISTRIBUTION IN THE
SE BRANSFIELD STRAIT
FEBRUARY - MARCH 1981

by
Manfred Stein
and
Stanislaw Rakusa-Suszczewski

Abstract

The highest densities of krill biomass occurred in the region of the greatest differences in the structure of water masses, above the continental shelf slope of the Antarctic Peninsula. Bottom topography affects the directions of water masses movements and the hydrodynamical processes which cause the formation of swarms.

Author's address: M. Stein
Bundesforschungsanstalt für Fischerei
Institut für Seefischerei
Palmaille 9
2000 Hamburg 50
Fed. Rep. Germany

THE AGE STRUCTURE OF A POPULATION OF THE ANTARCTIC KRILL
EUPHAUSIA SUPERBA DANA

by
George Ettershank

Abstract

The traditional method of studying age structure of krill by length frequency histograms is negated by observations that krill revert to an immature form and regress in size after spawning - indeed, this is part of their over-wintering strategy (Ettershank, in press, Ikeda and Dixon 1982, McWhinnie and Denys 1980). Study of the age pigment lipofuscin reveals that in the Prydz Bay population, five age classes of adult krill are present. The weight of evidence suggests that these are year classes, i.e. that they represent years 3, 4, 5, 6 and 7. Of 286 specimens analysed, 39.9% are year 3, 35.7% year 4, 14.3% year 5, 4.5% year 6 and 5.6% year 7. Regression lines fitted to this data had highly significant slopes ($p < 0.001$), were parallel and equally spaced. The body size as measured by standard length $\neq 4$ remained relatively constant, but it is suggested that body size started to diminish toward the end of summer. A growth model to explain the morphological events associated with negative growth is proposed.

References

- Ettershank G (in press) A new approach to the problem of longevity in the Antarctic krill Euphausia superba. J Crust Biol
- Ikeda T, Dixon P (1982) Body shrinkage: a possible over-wintering strategy of the Antarctic krill (Euphausia superba Dana). J Exp Mar Biol Ecol 62:143-151
- McWhinnie MA, Denys CJ (1980) The high importance of the lowly krill. Natural History 89:66-73
- Author's address: G. Ettershank
Department of Zoology
Monash University
Clayton, Vic. 3168
Australia

POPULATION STRUCTURE OF EUPHAUSIA SUPERBA IN THE EASTERN
PART OF THE BRANSFIELD STRAIT

by
Volker Siegel

One of the major problems in this special area is the population analysis in regard to stock management. This can be done in different ways. One method is introduced as the electrophoretic analysis of isoenzymes (allele frequencies). A different way might be the study of morphometric data. Measurements of carapace, abdominal segment, eye diameter, telson, and eupod length etc. have been done from stations of the Bellingshausen Sea, Bransfield Strait, northern Weddell Sea and south-eastern Weddell Sea. The results of the calculations done by multivariate discriminant analysis do not lead to significant differences between populations. There is evidently no discrimination between a Bellingshausen Sea and a Weddell Sea population. These results resemble the one of MacDonald and Schneppenheim obtained by electrophoresis. The data and results are, however, not published now, but will be done in a due course.

To get some other hints for populations or stocks it is necessary to collect more detailed data on the structure of the krill population off the Antarctic Peninsula.

During FIBEX year 1980/81 two German research vessels did some studies in the Bransfield Strait area over the whole summer season. At the beginning of December gravid females spread all over the northern exit of Bransfield Strait (Fig. 1). Horizontal bows indicate the occurrence, dense stripes show more than 60% gravid females (as percentage of all females). At that time no spent females were observed. Fig. 2 is showing the situation during January, horizontal bows for gravid females with less than 30%, and vertical bows for spent females. Dense concentrations of spawned females of more than 60% were found west of Elephant Island and south of King George Island.

In February (Fig. 3) the research area extended a little bit to the east. A rest of gravid females was obtained only in the eastern part (1-2%). Spent females were found everywhere, higher concentrations of more than 60%, however, again only in the eastern section. In March (Fig. 4) no more gravid stages occurred. The eastern area could not be investigated because of pack ice drifting out of the Weddell Sea.

If we have a closer view to the stages (Fig. 5) one can see that the juveniles are always dominating. The relative abundance (%) was highest in December, in January juveniles were at the lowest level, maybe due to the larger specimens that were running into male and female stages. From January onwards the relative number of juveniles was increasing again. On the other hand, the absolute number ($N/1000\text{ m}^3$) of juvenile krill was always increasing during the season and dropped only in March. This fits also the data for absolute numbers of male and female, a permanent increase over the summer and a sharp decline at the end of the season. This effect can be demonstrated also for the krill biomass (Fig. 6). The increase of the weight is even higher than for the total number, because of the growth of krill during that time.

Fig. 7 again shows gravid and spawned female stages. In December we found highest percentage and absolute number of gravid females, at that time no spent females were observed. In January number of gravid females was low, but concentration of spent females is high. In February and March gravid stages were running to zero. The number of spawned females decreased after January (the reason might be that the spawned stage is difficult to detect because of rejuvenation), the percentage value, however, remained stable. It is not clear where this population was coming from and when the number increased or where it was going to at the end of the season when there was a sharp decline, if they drifted from the west or the south into Bransfield Strait and left for the east or the south again.

There is another problem, the percentage value of gravid females is much lower than the one of spent females one month later, so they must have become gravid and spent somewhere else before.

Fig. 8 demonstrates the length frequency distribution (L in mm) of juvenile krill for different months. In December the size was relatively small (16-30 mm), but they are not normal distributed. In January they became larger, several distinct peaks were remaining. There was no greater change in size during February and March. In March, however, the absolute numbers are very low. At least for the smallest size-group in March one can be sure of the origin, these krill were only found in close vicinity of the pack ice border drifting out of the Weddell Sea.

The size frequency of adult krill (Fig. 9) is even more complicated and needs further analysis. One can find, however, that in March no krill larger than 52 mm was caught, this size group surely died after spawning.

The entire area is influenced by water masses from different origin, which are drifting and mixing, they are probably of different primary productivity and of course of different ice coverage. All these factors may influence maturation and growth of krill. Therefore we need more detailed studies further to the west, where there is no influence of Weddell Sea water on the Bellingshausen water to study a more uniform, unmixed population. Standard transects are needed (as planned for SIBEX) to watch water dynamics in combination to population dynamics over the whole season, to see where krill is coming from and where it is drifting to. More information is necessary on the very early season, to observe the starting point of maturation, and this can start before November/December shortly before pack ice is retreating.

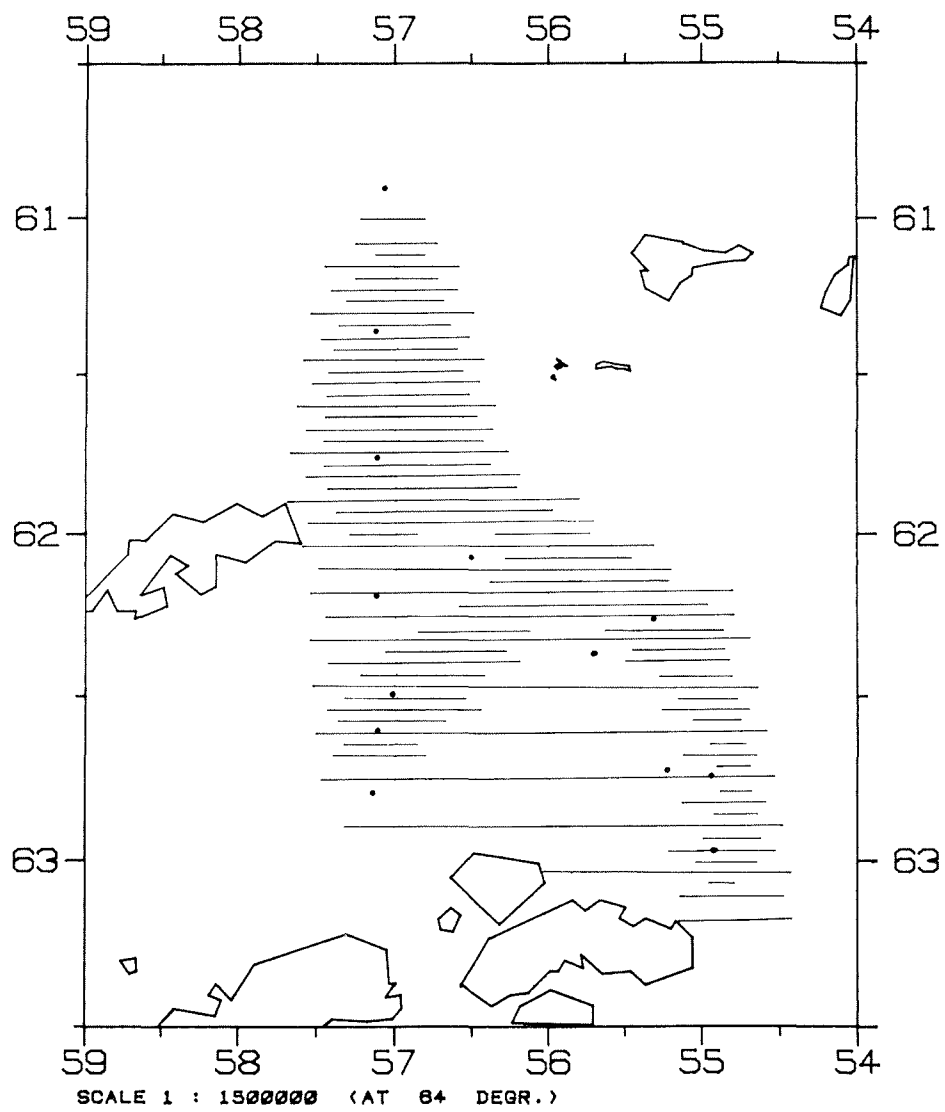

Fig. 1 Distribution of gravid females (≡) in December 1980.

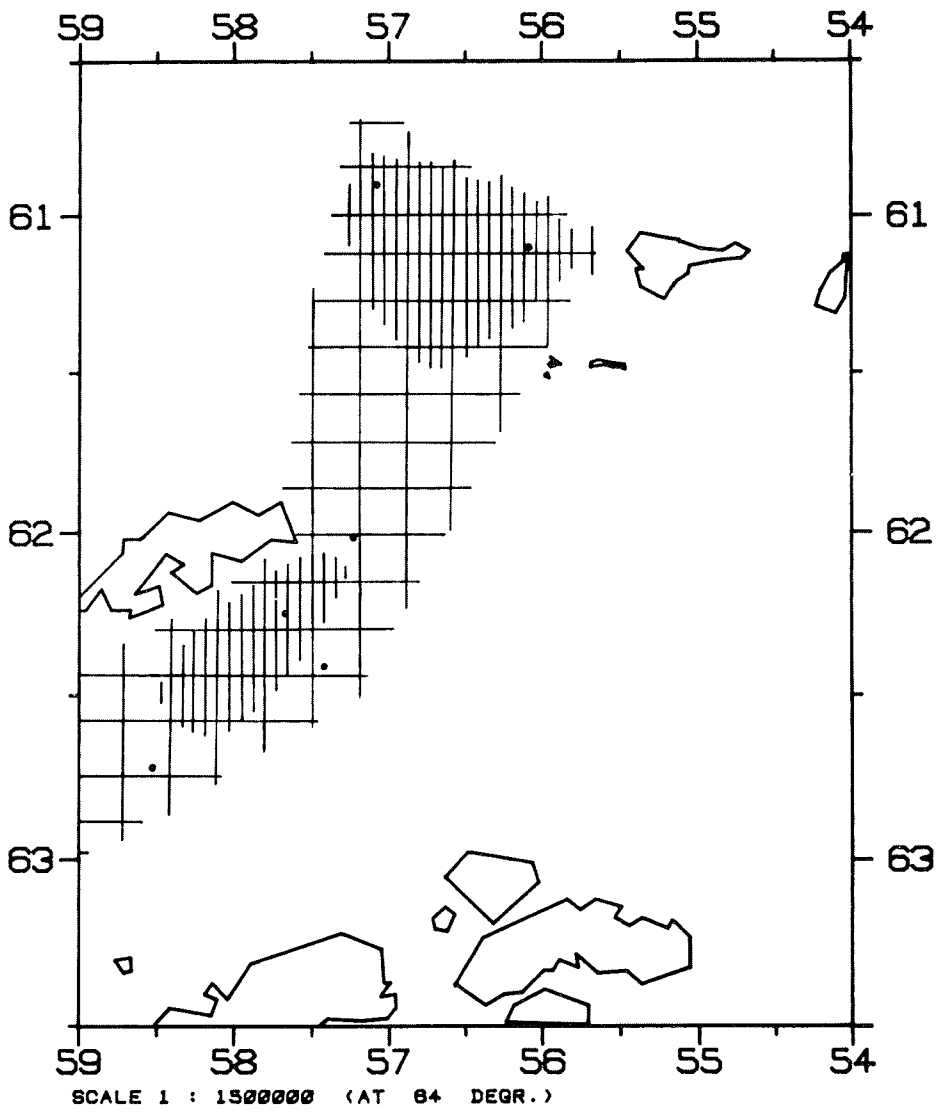

Fig. 2 Distribution of gravid (≡) and spent (||) females in January 1981.

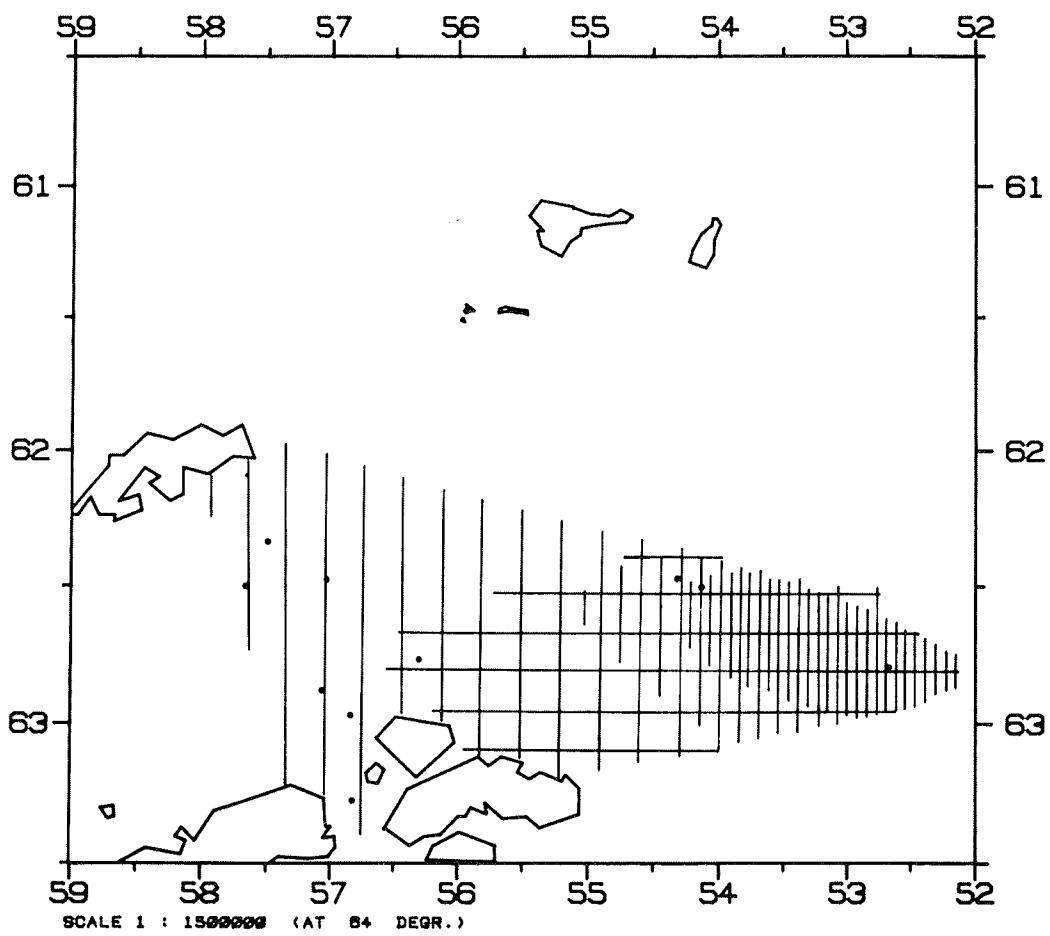

Fig. 3 Distribution of gravid (≡) and spent (||) females in February 1981.

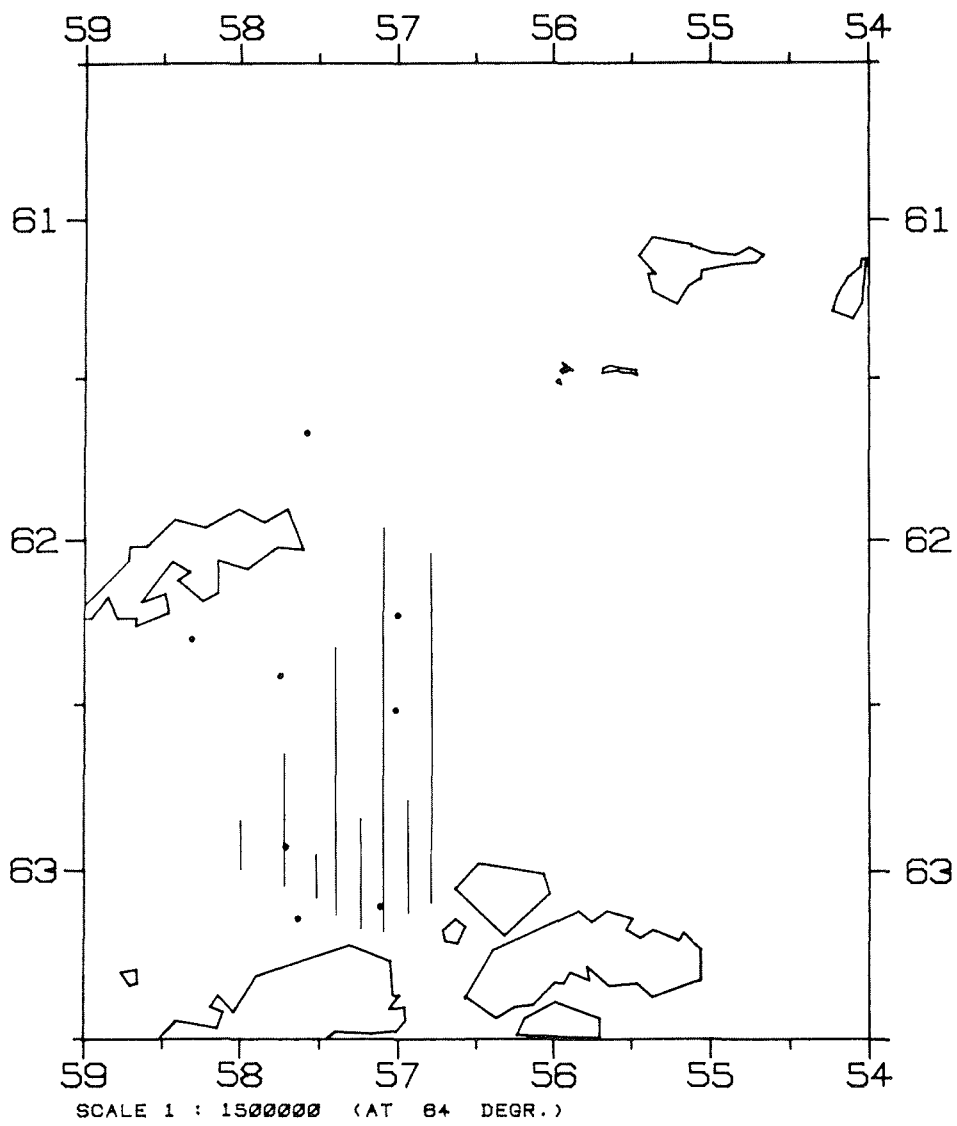

Fig. 4 Distribution of spent females (||) in March 1981.

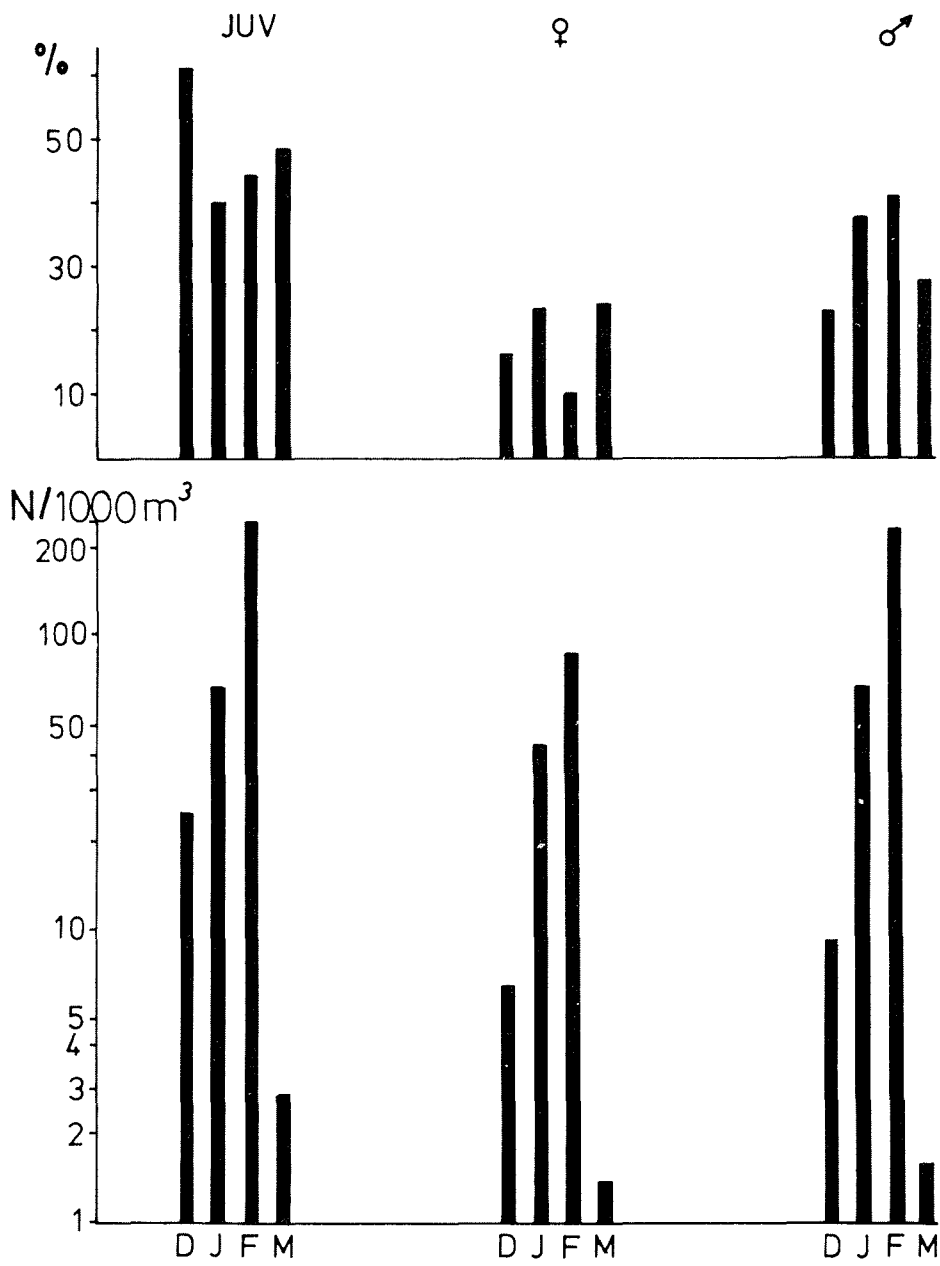

Fig. 5 Relative (%) and absolute (N/1000 m³) abundance of krill for different months.

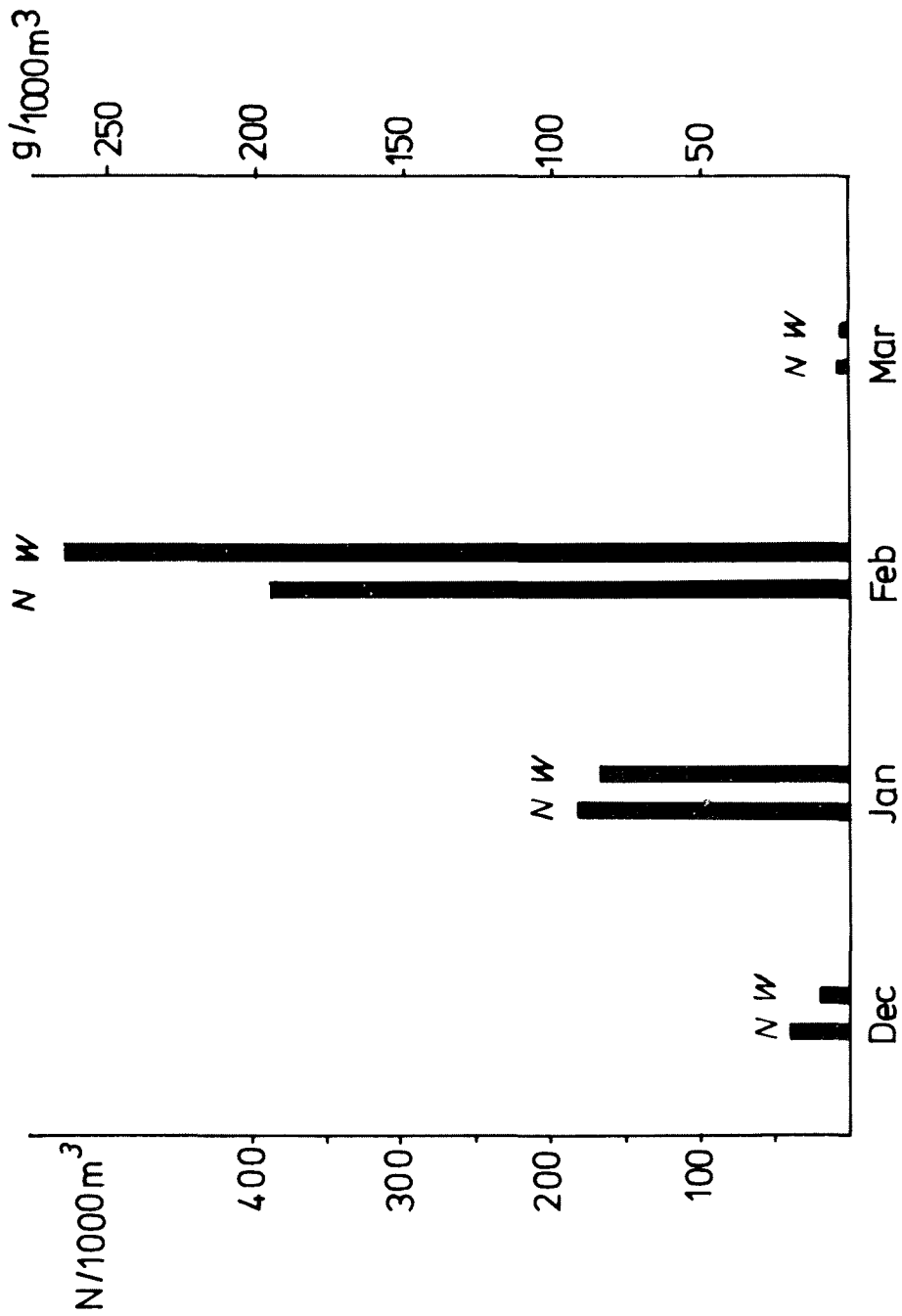

Fig. 6 Abundance (N) and biomass (W) of total krill in different months.

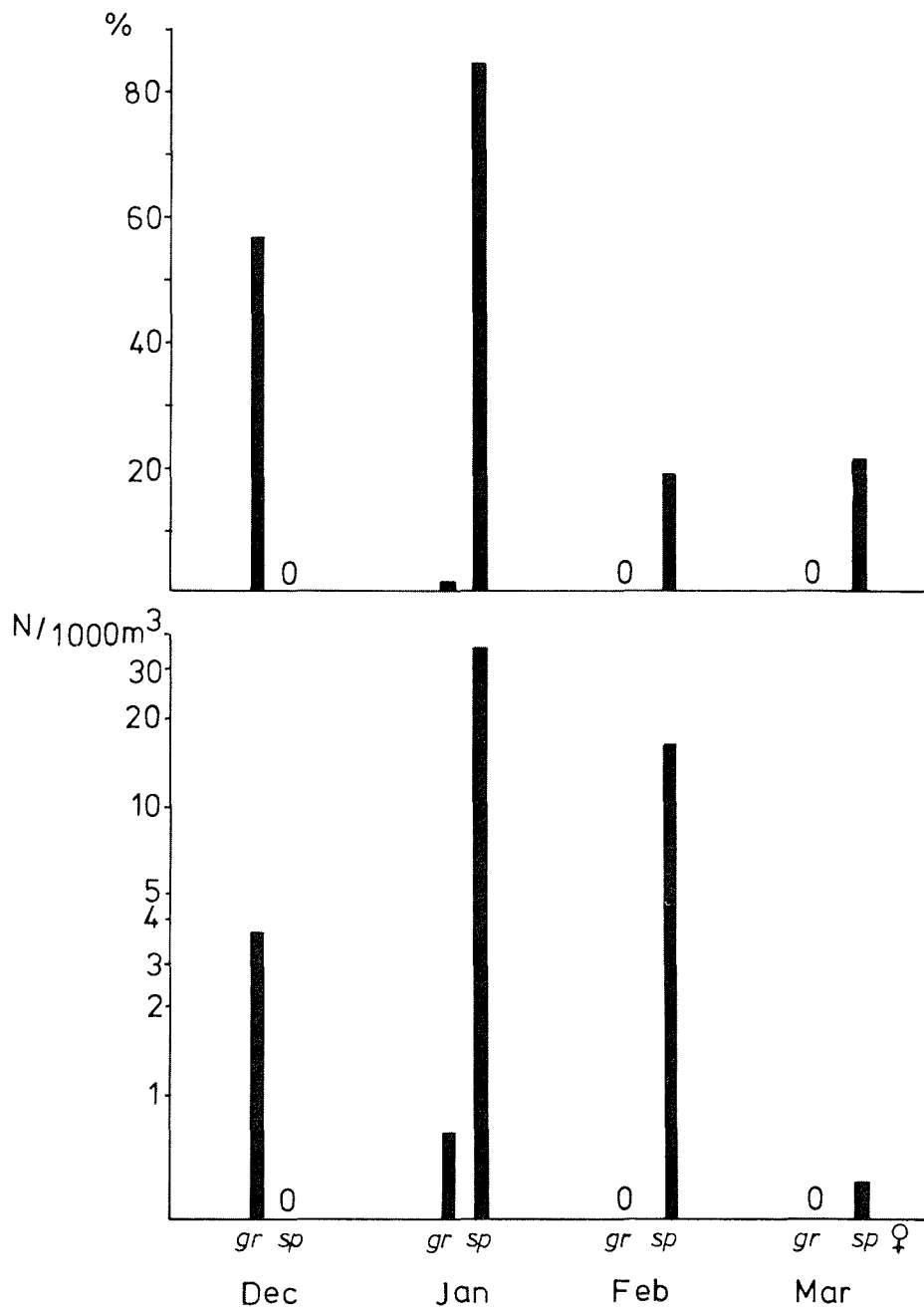

Fig. 7 Relative (%) and absolute (N/1000 m³) abundance of gravid (gr) and spawned (sp) females.

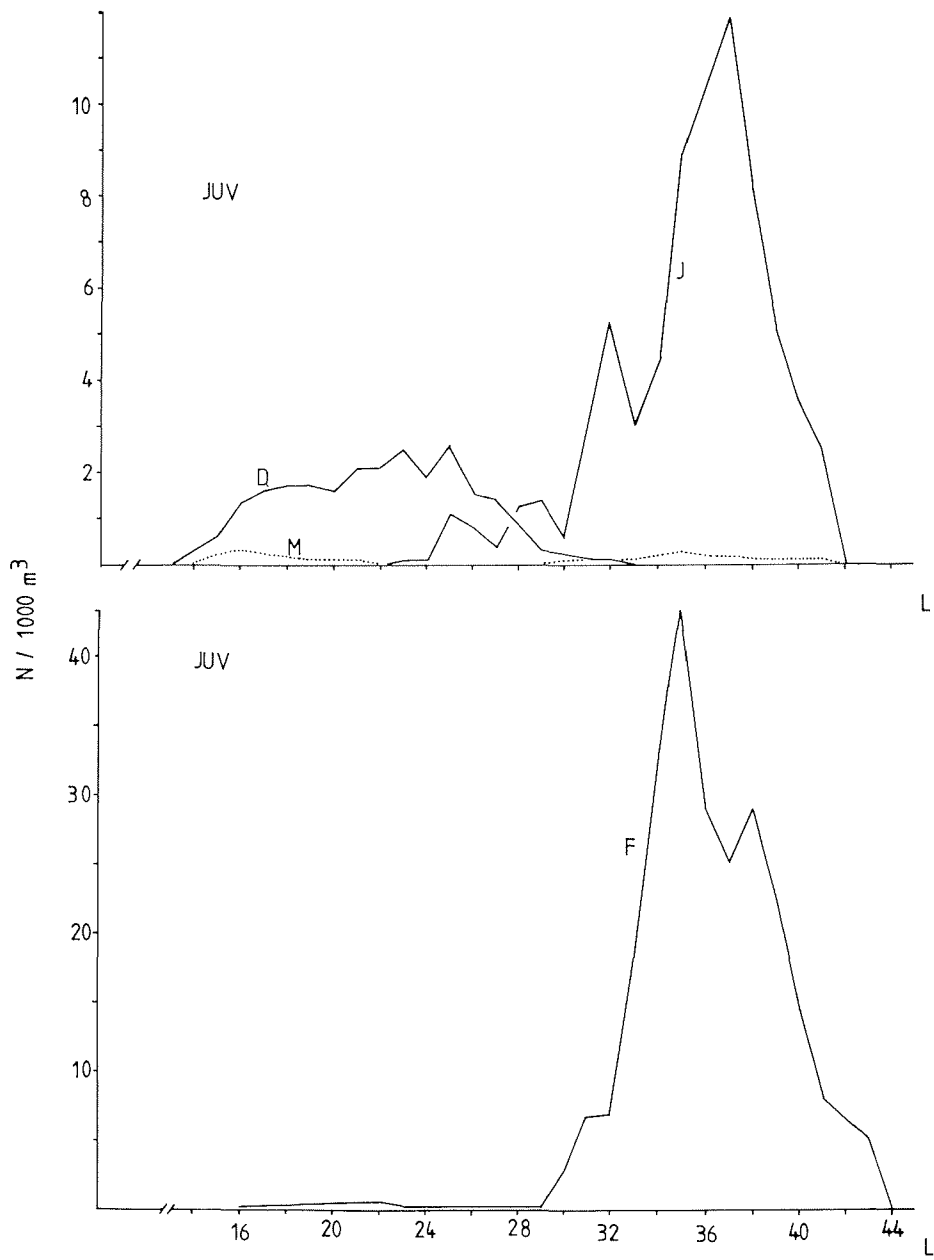

Fig. 8 Size distribution of juvenile krill for December (D), January (J), March (M) (upper graph) and February (F) (bottom graph).

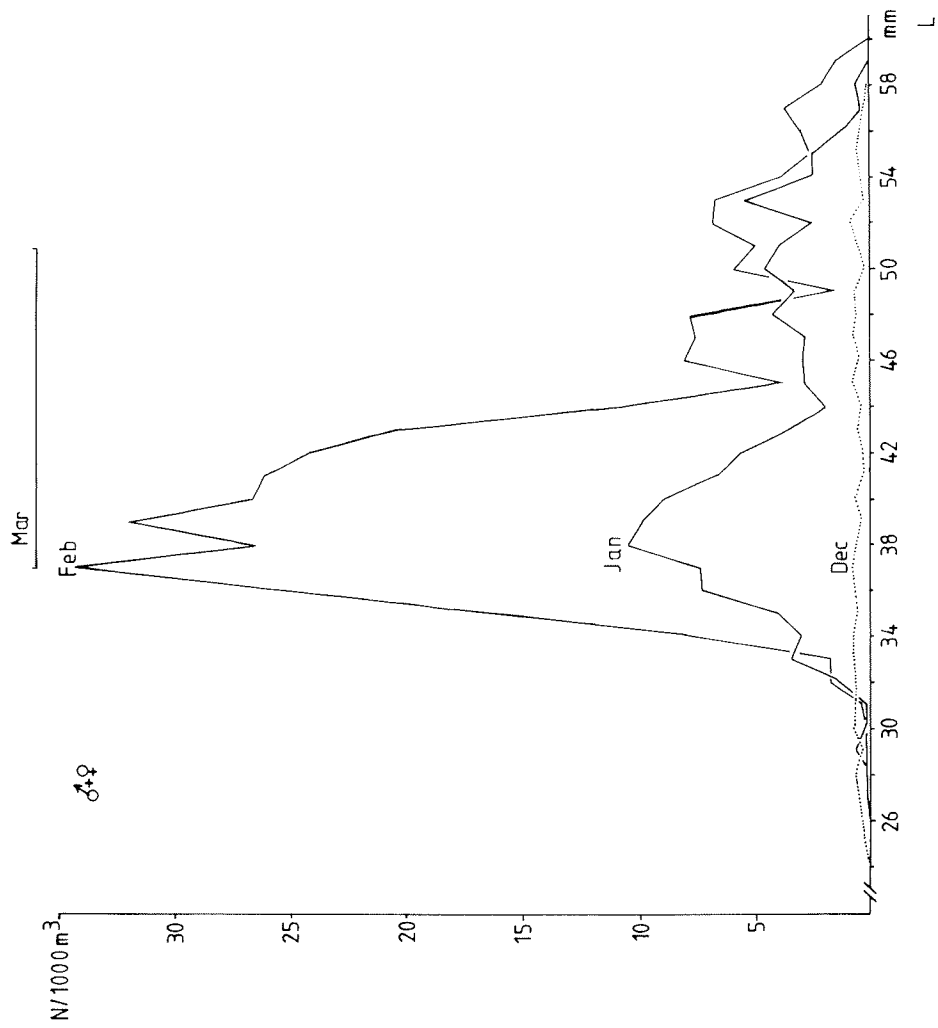

Fig. 9 Size distribution of adult krill for different months.

POPULATION GENETICS OF KRILL (EUPHAUSIA SUPERBA)

by

Reinhard Schneppenheim and C. Murray MacDonald

Abstract

Samples of Antarctic krill Euphausia superba from 16 different locations in the Weddell Sea, Scotia Sea and on the west coast of the Antarctic Peninsula were analysed for protein variation using enzyme electrophoresis techniques. Analysis of allele and phenotype distributions indicate that samples from all locations are part of a single breeding population of krill.

Spatial and temporal distribution of electrophoretically detected genetic variation in Atlantic and Pacific sector krill stocks proved to be almost homogenous. This finding is at odds with data published by previous authors (Fevolden and Ayala 1981) showing significant differences in allelic frequencies at six enzyme loci between three sample sets collected from the Atlantic sector of the Antarctic waters and one sample from off the west coast of the Antarctic Peninsula.

Since the previous study and our investigations only cover one part of the Antarctic waters we could not yet obtain a comprehensive picture of the number and dynamic distribution of interbreeding populations in the whole area.

The fundamental importance of such information in developing sound policies for future fishery management of E. superba stocks cannot be emphasised strongly enough.

References

Fevolden SE, Ayala FJ (1981) Enzyme polymorphism in Antarctic krill (Euphausiacea); genetic variation between populations and species. *Sarsia* 66:167-181.

BREEDING STRUCTURE AND STOCK IDENTITY
IN THE ANTARCTIC KRILL EUPHAUSIA SUPERBA DANA

by

C. Murray MacDonald and Reinhard Schneppenheim

Abstract

Studies of the role of krill in the Antarctic marine ecosystem and assessments of its potential for commercial exploitation have been hampered in part by the failure of traditional approaches (e.g. tagging, morphology and length frequency analysis) to provide information on the number and distribution of discrete breeding populations in Antarctic waters.

Electrophoretic analysis of proteins has recently been employed to estimate the geographical and temporal distribution of genetic variation in krill, thereby providing information on breeding structure of the species. Electrophoretic data obtained so far from samples collected around the Antarctic Peninsula and from the Atlantic and Indian Ocean sectors of Antarctic waters support the hypothesis of a single interbreeding population of krill throughout the sampled range of the species. Further sampling from all areas of Antarctic waters and repeated sampling in key locations is required to confirm this finding.

Introduction

The Antarctic krill Euphausia superba Dana is the most abundant zooplankton in the Southern Ocean. Studies of the life history, behaviour and ecology of this species have proliferated in recent years because of the apparently central role assumed by this organism in the Antarctic marine ecosystem, and because of its potential for commercial exploitation.

Hypotheses concerning the dispersal capabilities and breeding structure of krill have been numerous but quantitative information has been scarce. Early observations on krill indicated a circumpolar but patchy distribution of the species. The existence of circumpolar water currents and knowledge of the planktonic habits of krill led to the conclusion that the species was probably behaving as a single interbreeding population throughout its Southern Ocean distribution.

In recent years observations of the association of high concentrations of krill with particular water masses such as cyclonic gyres has led to numerous inferences that such local concentrations are discrete self-maintaining populations.

An understanding of the number and distribution of distinct breeding populations is necessary not only for the development of soundly based management policies for commercial exploitation of krill, but also to assess both the regional and circumpolar impact of localised alterations in krill abundance on the various components of the Antarctic marine ecosystem.

Definition of terms

In discussing population studies of krill or any other naturally occurring species a clear distinction should be made between the meaning and appropriate usage of the terms "stock" and "population". These two terms are often used interchangeably, resulting in confusion and misunderstanding in the communication and interpretation of results. For present purposes the two terms are defined as follows.

Stock - the total number (or biomass) of krill present in a certain area at a certain time.

The term "stock" originated from, and is most often used in relation to, fisheries science. In this context a stock is the total amount of a resource available for exploitation in a given area at a given time.

Population - a group of interbreeding krill which are self-maintaining and can be distinguished in some way from other such groups.

A stock is therefore defined in spatio-temporal terms and many consist of one or more populations, while a population is defined in biological and/or genetic terms regardless of its distribution.

Methods

Information on the breeding structure and dispersal capabilities of krill is very limited because of the failure of traditional techniques to provide useful results on this subject. Tag and recapture approaches have not been used because a successful tagging technique has not been developed for krill, and in any case the current level of exploitation of krill is so low that the chances of obtaining meaningful recapture data are extremely small. The use of variation in morphological or life-history characters to infer discrete populations in different areas is also suspect, because such variation may be environmentally determined rather than reflecting the divergence of reproductively isolated populations. Analysis of length frequency distributions in particular is not appropriate for studies of breeding structure because of the possibility that krill may actually diminish in size and alter external morphological characteristics under starvation conditions during the Austral winter.

An alternative approach to population studies of krill involves the use of biochemical techniques to detect and measure the spatio-temporal distribution of genetic variation. Breeding structure can be inferred on the basis of restricted

gene flow as indicated by discontinuities in the distribution of gene frequencies. A number of biochemical genetic techniques could possibly be used, some of which directly measure nucleotide substitutions in DNA, and others which indirectly measure genetic variation through the detection of aminoacid substitutions in the protein products of genes. The advantages and limitations of these techniques are more fully discussed elsewhere in these proceedings (Dr. S. Grant - Population Genetics of Krill). It is sufficient here to note that only electrophoretic analysis of enzymatic proteins has so far been successfully applied to population studies of krill. A second technique - analysis of nucleotide substitutions in mitochondrial DNA using restriction endonucleases - offers some promise for krill studies but still requires further development.

Distribution of genetic variation in krill

Initial electrophoretic studies on krill were carried out by Ayala et al. (1975) on a single sample set of specimens collected from the Pacific side of the Antarctic Peninsula. Fevolden and Ayala (1981) compared these data with more recent results obtained from specimens collected near Bouvet Island in the Weddell drift. They found evidence of significant differences in gene frequencies between the two areas sampled, and interpreted this as evidence for the existence of separate populations with origins in the Bellingshausen and Weddell Seas respectively.

More recently Schneppenheim and MacDonald (in press) electrophoretically analysed some 4,500 krill specimens from 16 locations in the Scotia and Weddell Seas and around the Antarctic Peninsula (including the area previously sampled by Ayala et al.). This study indicated a striking homogeneity of gene frequencies throughout the sampled area and, despite some difficulty in comparing results of different studies, agreed with results for the Bouvet Island samples produced by Fevolden and Ayala (1981). Further studies carried out on

1,200 samples from six locations in the Prydz Bay (Indian Ocean sector) region of the Southern Ocean (MacDonald, unpublished data) indicated strong homogeneity of gene frequencies within the sampled area and furthermore agreed very closely with the data obtained by Schneppenheim and MacDonald for the Atlantic sector.

Thus, with the exception of the Ayala et al. (1975) data, all electrophoretic analyses to date support the hypothesis of a single interbreeding population of krill across the sampled area from the Antarctic Peninsula to the Prydz Bay region. It should be stressed that such a hypothesis does not require the movement of substantial numbers of krill across the entire range of the species in the space of one generation.

Assuming several geographically distinct spawning areas occur, movement and interbreeding between krill from adjacent areas only would be sufficient for all stocks to be considered part of one interbreeding population. Furthermore, knowledge of the environmental tolerance limits and dispersal capabilities of both juvenile and adult krill suggest that, in spite of observed patchy distribution, there are no oceanographic or physiological barriers to prevent krill from dispersing freely throughout waters south of the Antarctic Convergence.

The unusual results obtained by Ayala et al. (1975) on the Pacific side of the Antarctic Peninsula emphasise three points in relation to future studies of krill breeding structure and stock identity:

- (a) Sampling must be conducted throughout the entire range of krill - i.e. in all sectors of the Southern Ocean - to confirm the existence of a single population or alternatively to detect two or more discrete populations.

- (b) Laboratory analysis techniques and proteins screened must be standardised so that results from various studies can be directly compared.

- (c) Repeat sampling over time should be conducted in key locations to detect temporal variation in the distribution of gene frequencies. If separate populations exist such data will help to estimate the degree of mixing in the sampled localities.

References

- Ayala FJ, Valentone JW, Zumwalt GS (1975) An electrophoretic study of the Antarctic zooplankton Euphausia superba Dana. *Limnol Oceanogr* 20:635-640
- Fevolden SE, Ayala FJ (1981) Enzyme polymorphism in Antarctic Krill (Euphausiacea); genetic variation between populations and species. *Sarsia* 66:167-181
- Schneppenheim R, MacDonald CM (in press) Genetic variation and population structure of krill (Euphausia superba) in the Atlantic sector of Antarctic waters and off the Antarctic Peninsula. *Polar Biol*

POPULATION GENETICS OF KRILL AND COMPARISON
WITH OTHER MARINE ORGANISMS

by
W. Stewart Grant

Summary

A rationale is presented for using biochemical methods to describe the genetic population structure of the Antarctic zooplankter, Euphausia superba (krill). Although several biochemical methods are available, the study of the geographic distributions of electrophoretically-detectable protein variants appears to be the best available method for studying krill populations. The results of genetic studies of several marine and aquatic organisms are compared to the results of previous electrophoretic studies of krill using genetic distance, gene-diversity analyses, and gene-flow analyses. These comparisons show that pelagic species, which have large population sizes and large potentials for gene flow between populations, show little genetic subdivision over several thousand kilometers. The potential causes of genetic subdivision in pelagic species are reviewed from a population genetic point of view, and it is concluded that, if genetic subdivision among krill populations exists, the most likely cause is adaptive divergence following the imposition of a physical barrier to migration. It is recommended that in future studies of krill genetics:

- 1) a large number of polymorphic proteins be examined to provide a statistically sufficient description of population structure;
- 2) sample sizes be at least 200 krill per location to be able to detect low levels of genetic divergence; and
- 3) samples be collected from the entire circumference of Antarctica.

Introduction

The primary goal of studies of stock structure is to infer the amount of migration between areas and to estimate the degree of independence among stocks. One direct means of measuring migration between areas is tag-and-recovery methods. But, since it is not possible to conduct such studies with krill because of an inability to tag krill and because of inadequate means of recovering tagged individuals, indirect methods must be used. One of these methods is to search for demographic or morphological differences between areas. However, such differences may result from short-term environmental influences and may not reflect genetic differences due to reproductive isolation. A better approach is to measure genetically-determined characters, which reflect the reproductive histories of the populations.

The objectives of this paper are:

- 1) to review and evaluate the various biochemical methods available for examining the genetics of krill populations;
- 2) to compare the results of previous studies of krill with genetic data of other marine organisms with the intention of showing that little genetic divergence among krill populations is expected because of its large population sizes and extensive flow between areas;
- 3) to identify the most important causes of genetic subdivision in pelagic organisms; and
- 4) to recommend a sampling strategy for future studies of krill genetics.

Detection of genetic variation

All of the information needed for the development and maintenance of an organism is contained in the sequences of 4 different nucleotide bases in DNA. Mutations in these sequences, brought about by nucleotide substitutions, can produce inherited changes in the corresponding proteins.

Direct or indirect measurements of these substitutions can be used to infer the amount of genetic divergence between taxa ranging from populations to orders.

One technique, taken from genetic engineering, has recently been applied to the study of natural populations (Awise et al. 1979). DNA is isolated and digested with restriction (cleaving) endonucleases that recognize particular nucleotide sequences, and the resulting fragments are sized electrophoretically for comparison with digested DNA of other populations. Changes in the number and sizes of the fragments reflect nucleotide substitutions, and the number of differences is taken as a measure of genetic divergence. The critical step in this method is the isolation of intact mitochondria, usually from fresh soft tissues such as heart muscle or liver. Although in theory this method is more sensitive to DNA differences than protein electrophoresis, it may not be possible to apply it to the study of krill because of inadequate amounts of soft tissues in krill.

The remaining methods indirectly measure changes in DNA sequences by measuring some attribute of the corresponding proteins. These include amino acid sequencing, immunological analysis (e.g. microcomplement fixation), and protein electrophoresis. The first two methods are costly and time consuming and are generally not available to biologists wishing to gather data on a large number of individuals from a large number of locations. The last of these methods, electrophoresis, is the most widely-used biochemical method for studying natural populations. However, this method only measures amino acid replacements that produce electrostatic charge or conformational differences affecting electrophoretic mobility, and, hence, can detect only about 25 to 30% of the total number of amino acid replacements (Nei 1975, King and Wilson 1975). It is, nonetheless, possible to examine a large number of protein-coding loci for making statistically meaningful comparisons between populations.

It is necessary firmly to establish the genetic basis of the electrophoretic variants because variation can also result from extraction procedures, changes during sample storage, or developmental changes in gene expression. The Mendelian basis of protein polymorphisms has been demonstrated through breeding studies for a large number of organisms including fishes (e.g. Allendorf and Utter 1979) and crustaceans (e.g. Hedgecock et al. 1977). Whenever it is not possible to conduct breeding studies, the genetic basis of the variants may be inferred using four criteria:

- 1) comparisons with genetic variation in related organisms (e.g. Shaklee and Whitt 1981);
- 2) banding variation should match that predicted from the subunit structure of the protein being considered (Darnall and Klotz 1975);
- 3) when a gene is expressed in more than one tissue, variant phenotypes should be parallel among tissues; and
- 4) fit to Castle-Hardy-Weinberg proportions in samples taken from breeding populations (Fairbairn and Roff 1980).

Since the patterns of divergence among populations primarily reflect the effects of migration, genetic drift, and natural selection, it is necessary to understand the importance of natural selection on electrophoretically-detectable alleles in order to interpret allele-frequency distributions in terms of migration and genetic drift. However, the selective values of genotypes at single loci are exceedingly difficult to evaluate. Although enzyme-kinetic differences have been demonstrated between allozymes in vitro, it is difficult to show that these single-locus differences are visible to selection through the whole organism. On the other hand, a large body of evidence suggests that genetic drift and gene flow rather than selection are the principle forces determining the geographic distributions of electrophoretic variants (Aspinwall 1974, Kimura and Ohta 1974, Maruyama and Kimura 1974, Somero and Soulé 1974, Fuerst et al. 1977, Chakraborty et al. 1978).

Thus, we are presented with the problem of deciding how to use allele-frequency data. Can the geographic distributions of electrophoretic variants be used to infer the extent of gene flow and isolation among populations? Allendorf and Phelps (1981) suggest that they can, by assuming that the effects of selection are negligible. They suggest two reasons for assuming a null hypothesis of selective neutrality. Firstly, different loci produce similar estimates of divergence, as expected under a model of neutrality, and secondly, there are many possible models of selection but there is no basis for choosing a particular model to explain a set of results.

Population genetics of krill

Population genetic theory predicts that:

- 1) divergence among populations having large amounts of gene flow is less than that among populations with reduced gene flow;
- 2) genetic drift is more important in causing divergence among small populations than it is for large populations;
- 3) the rate of divergence among large populations is less than that among small populations (Crow and Kimura 1970).

There is a large body of genetic data for marine organisms having different population sizes and different patterns of gene exchange from which it is possible to test these predictions.

Valentine and Ayala (1974), Ayala et al. (1975), and Fevolden and Ayala (1981) examined electrophoretic variation in four samples of krill collected from locations extending from the western side of the Antarctic Peninsula to Bouvet Island, a distance covering about 20% of the circumference of Antarctica. More recently Schneppenheim and MacDonald (unpublished) examined 16 samples from locations extending from the Antarctic Peninsula to the South Georgia Islands. In this section three statistical procedures, genetic distance, gene-diversity analysis, and gene-flow analysis are applied to these data and

compared with data from other marine organisms having different levels of interpopulational migration. The differences in the amount of population subdivision for these organisms are taken to be reflections of differences in the amount of genetic drift and gene flow between populations.

Genetic distance

Although several measures of genetic distance have been described, the genetic distance, D , of Nei (1972) and its standard error (Nei and Roychoudhury 1974) are widely used to quantify the amount of divergence between populations. D is calculated for each locus separately, averaged over all loci examined (including monomorphic loci), and under certain assumptions may be interpreted as the average number of amino acid differences per protein between two populations.

Typical values of D between populations of fishes or crustacea are presented in Tab. 1. The average D between populations of pelagic species such as krill, anchovies and herring is usually less than 0.005, even for populations separated by as much as 6,000 km, as in American and European populations of Atlantic herring (Grant in press a). The low amount of genetic divergence between populations is, for the most part, the result of a large potential for migration between areas. Genetic distances between populations of demersal organisms, such as cod and lobsters (Homarus), are generally higher because of the reduction in the amount of gene flow between populations. In freshwater fishes where gene flow is restricted by intervening land, genetic distances between conspecific populations are usually greater than 0.01 but less than 0.10.

Gene-diversity analysis

The gene-diversity analysis of Nei (1973, 1975) describes how the total genetic diversity in a set of samples is distributed within and among populations at any number of levels of populations subdivision. For instance, the model used to

Tab. 1 Average genetic distance between populations of marine and aquatic organisms.

Species	D	SE	No. Loci	References
Pelagic				
Krill	0.0004	0.0003	17	Schneppenheim and MacDonald (unpubl.)
	0.004	0.002	31	Fevolden and Ayala (1981)
Cape Anchovy	0.002	0.001	35	Grant (unpubl.)
Atlantic herring	0.001	0.000	40	Grant (in press a)
Pacific herring				
within races	0.003	0.002	40	Grant (in press b)
between races	0.039	0.021	40	
Demersal				
Pacific cod	0.008	0.007	41	Grant et al. (in prep)
Lobsters (<u>Homarus</u>)				
within species	0.006	0.001		Tracey et al. (1975)
between species	0.110	0.007		Hedgecock et al. (1977)
Fresh water				
Cutthroat trout	0.015	-		Campton (1981)
Lake whitefish	0.013	0.008		Ihssen et al. (1981)

analyse the krill data of Schneppenheim and MacDonald (Fig. 1B) consisted of comparisons between regions (Bellingshausen and Scotia Seas), between areas within each region and among subpopulations within areas such that

$$H_T = H_S + D_{SA} + D_{AR} + D_{RT}$$

where H_T is the total gene diversity, H_S is the average within-populational heterozygosity, D_{SA} is the gene diversity due to subdivision of areas into subpopulations, D_{AR} is the diversity due to subdivision of regions into areas, and D_{RT} is the diversity due to subdivision into regions. Computational formulae are presented in Chakraborty (1980). Even though each locus experiences the same population events, the amount of divergence observed at each locus varies because of random effects. Thus, the best estimate of divergence is the average over loci.

Fevolden and Ayala (1981) examined 3 samples of krill for the gene products of 31 loci which were in common with those examined by Ayala et al. (1975) for one sample of krill from the Bellingshausen Sea. The analysis of these four samples is presented in Tab. 2. For these data the total gene diversity (heterozygosity of alleles averaged over all samples) was 0.100, and the average gene diversity within populations was 0.098 ± 0.025 , which represented 97.2% of the total gene diversity. Small amounts of the total gene diversity were due to differences between Bouvet Island samples (0.2%), and between these samples and the Orkney Island samples (0.4%), but a slightly greater proportion of the total was due to differences between these three samples and the one from the Bellingshausen Sea (2.2%).

Schneppenheim and MacDonald (unpublished) examined 17 protein-coding loci with a complete set of data for 15 samples from location extending from the Bellingshausen Sea to the South Georgia Islands in the Scotia Sea. The average within populational diversity was 0.116 ± 0.047 (Tab. 3) and was not

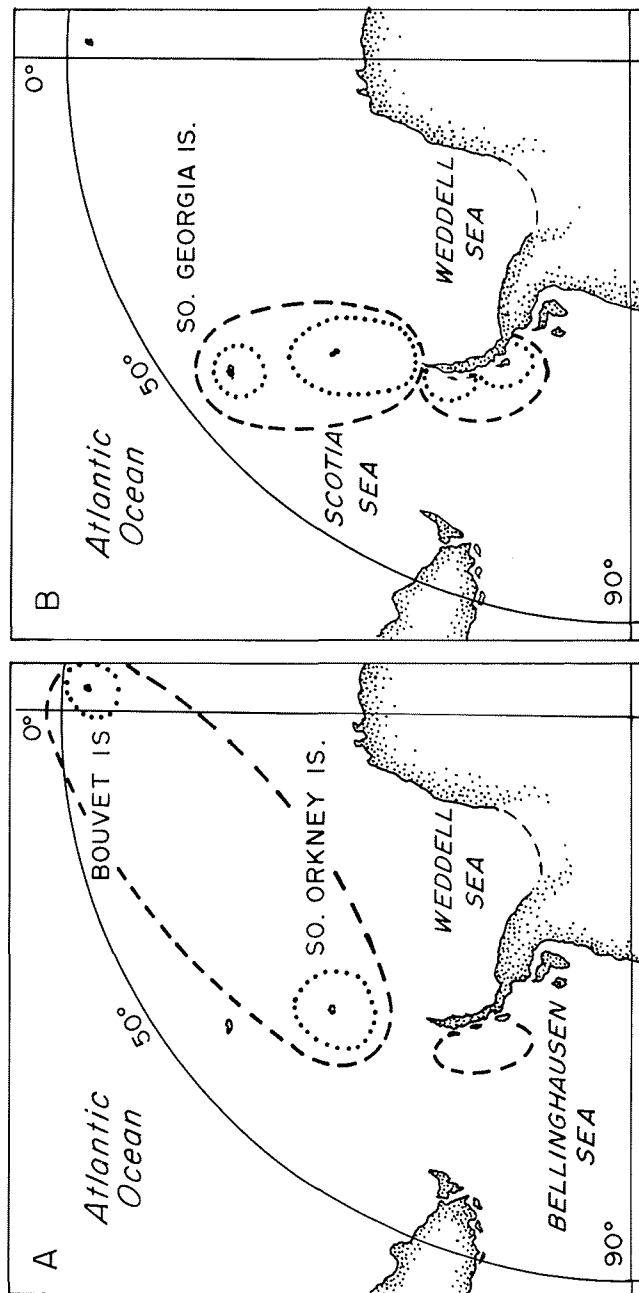

Fig. 1 Maps showing subdivision model for gene-diversity analyses of krill data of (A) Fevolden and Ayala (1981) and (B) Schneppenheim and MacDonald (unpublished).

Tab. 2 Gene-diversity analysis of allelic frequencies of krill samples from Fevolden and Ayala (1981).

Locus ^a	Absolute gene-diversity		Relative gene-diversity (%)			
	Total	Within populations	Within populations	Between Bouvet Is. samples	Between Bouvet and S. Orkney Is.	Between Bellingshausen and Bouvet-S. Orkney Is.
<u>Aat</u>	0.460	0.453	98.4	0.3	0.9	0.3
<u>Ao-1</u>	0.264	0.257	97.3	0.2	0.1	2.4
<u>Ald-1</u>	0.058	0.057	98.6	0.1	1.0	0.4
<u>Ald-2</u>	0.243	0.241	99.2	0.1	0.5	0.2
<u>Est-1</u>	0.226	0.225	99.8	0.0	0.1	0.1
<u>Est-5</u>	0.412	0.375	90.9	0.1	0.1	8.8
<u>Gpi</u>	0.459	0.443	96.6	0.4	0.1	2.9
<u>Hk-1</u>	0.173	0.171	98.6	0.2	0.1	1.1
<u>Hk-2</u>	0.089	0.088	98.4	0.6	0.0	1.1
<u>Mdh-3</u>	0.225	0.223	99.4	0.0	0.6	0.0
<u>Me-2</u>	0.195	0.184	94.1	1.5	2.0	3.8
<u>Odh</u>	0.116	0.115	99.3	0.1	0.4	0.2
Average	0.100 ^b	0.098 ^b	97.2	0.2	0.4	2.2

^a Only loci having a most-common-allele frequency of 0.95 or less.

^b Includes 9 monomorphic and 10 loci having variant-allele frequencies less than 0.05.

Tab. 3 Gene-diversity analysis of allelic frequencies for 15 populations of krill from study by Schneppenheim and MacDonald (unpubl.).

Locus	Absolute gene-diversity		Relative gene-diversity (%)			
	Total	Within populations	Within populations	Between populations within areas	Between areas within seas	Between Bellingshausen and Scotia Seas
<u>Aat</u>	0.546	0.544	99.7	0.2	0.0	0.1
<u>Gpi</u>	0.488	0.487	99.9	0.1	0.0	0.0
<u>Mpi</u>	0.137	0.136	99.7	0.2	0.1	0.0
<u>Gda</u>	0.116	0.116	99.6	0.2	0.1	0.1
<u>Est</u>	0.522	0.520	99.6	0.3	0.1	0.0
<u>Ldh</u>	0.070	0.069	99.2	0.7	0.0	0.1
<u>Pgm</u>	0.106	0.105	99.8	0.2	0.0	0.0
Mean	0.117 ^a	0.116 ^a	99.7	0.2	0.1	0.0

^a Includes 10 additional monomorphic loci.

significantly different from that estimated for the 3 samples of Fevolden and Ayala (1981), but was significantly greater than the estimate of Ayala et al. (1975). In contrast to the results of the previous studies, more of the gene diversity was contained within populations (99.7%), and less of the diversity was due to differences between populations (0.2%), areas (0.1%) or between the Bellingshausen and Scotia Seas (0.0%).

There are two possible explanations for the different estimates of divergence between krill of the Bellingshausen and Scotia Seas in these studies. The first is that a genetically distinct migratory population was sampled by Ayala et al. (1975) but not by Schneppenheim and MacDonald (unpublished). Another explanation is that the electrophoretic analysis differed between the studies of Ayala et al. (1975) and Fevolden and Ayala (1981).

The relative gene diversities (%) of krill are compared in Tab. 4 with those of other marine organisms having different amounts of migration and different population sizes. This list is by no means complete, but is meant to give examples of typical values. One caveat is necessary when comparing the results of different studies where the geographic extent of the samples varied. As the geographic area covered by a study increases there is a greater chance of detecting additional genetic subunits, such as races or subspecies. When this occurs the amount of total gene diversity rapidly increases. For this reason the gene diversities are arranged in columns comprising results from similar geographic areas.

One trend is apparent from these comparisons; as the amount of gene flow increases, the amount of diversity due to differences among populations decreases. Pelagic species show few genetic differences among populations extending over thousands of kilometers and the amount of gene diversity due to all population differences combined is usually less than 1.5%. Demersal species, such as cod and lobsters, show relatively

Tab. 4 Relative gene diversities (%) for species of pelagic, demersal and freshwater organisms.

Species	Geographic range (km)	Poly. ^a loci	H _S	Regions	Areas	Pops.	Streams lakes	Years	Dates	Ref. ^b
Pelagic										
Krill	1200	7	99.7	-	0.2	0.1	-	-	-	1
	4000	13	97.2	-	2.2	0.6	-	-	-	2
Cape anchovy	1600	10	98.9	-	0.8	0.2	-	-	-	3
Calif. anchovy	1500	1	98.8	-	0.7	0.2	-	0.1	0.2	4
Atlantic herring	6000	8	98.7	0.3	0.6	0.4	-	-	-	5
Pacific herring	9000	13	83.4	15.1	0.6	0.7	-	0.2	-	6
Demersal										
Pacific cod	9000	7	78.1	18.6	0.4	-	-	-	-	7
Lobsters (<u>Homarus</u>)	6000	12	59.7	32.1	5.6	2.6	-	-	-	8
Fresh water										
Cutthroat trout	800	13	93.7	-	1.6	4.9	2.8	1.3	-	9
Lake whitefish	1500	5	92.8	-	9.7	5.4	0.8	-	0.2	10

^a Number of polymorphic loci with common allele frequencies less than 0.95.

^b 1, Schneppenheim and MacDonald (unpubl.); 2, Fevolden and Ayala (1981); 3, Grant (unpubl.); 4, Vrooman et al. (1981); 5, Grant (in press a); 6, Grant (in press b); 7, Grant et al. (in prep); 8, Hedgecock et al. (1977), Tracey et al. (1975); 9, Campton (1981); 10, Ihssen et al. (1981)

more divergence among populations, and freshwater fishes show even greater divergence. For instance, genetically distinct populations of trout can be found in lakes or streams separated by only a few kilometers.

Gene-flow analysis

In a simulation study of selection, mutation, genetic drift, and migration, Slatkin (1981) found that the average frequency of an allele, $\bar{p}(i)$, conditioned on the number of populations, i , in which it appeared, depended most strongly on the level of gene flow between populations. He showed that the distribution of $\bar{p}(i)$ in a set of population data could be used to make a rough estimate of the level of gene flow between populations. The results of this analysis for krill and for three other species having different levels of gene flow are presented in Fig. 2, where $\bar{p}(i)$ is plotted against the number of populations, i , in which it appeared. To compare studies having different numbers of samples, i is divided by the number of samples, d , for each study. The convex curve for the salamander, Plethadon, is typical for species living in highly subdivided populations. The irregularities in the curve result from sample sizes (typical for population genetic studies) that are too small adequately to estimate the distribution of $\bar{p}(i)$. Populations of American and European lobsters have intermediate levels of gene flow, which occurs primarily at the pelagic larval stage. The extreme concave curves for Pacific herring and for krill are typical of species having very high levels of gene flow among populations.

It is not possible using this analysis to estimate the actual number of migrants needed to account for the observed level of divergence between krill populations. However, this quantity can be estimated using the island model of migration and Wright's (1969) measure of divergence, F_{ST} . At equilibrium

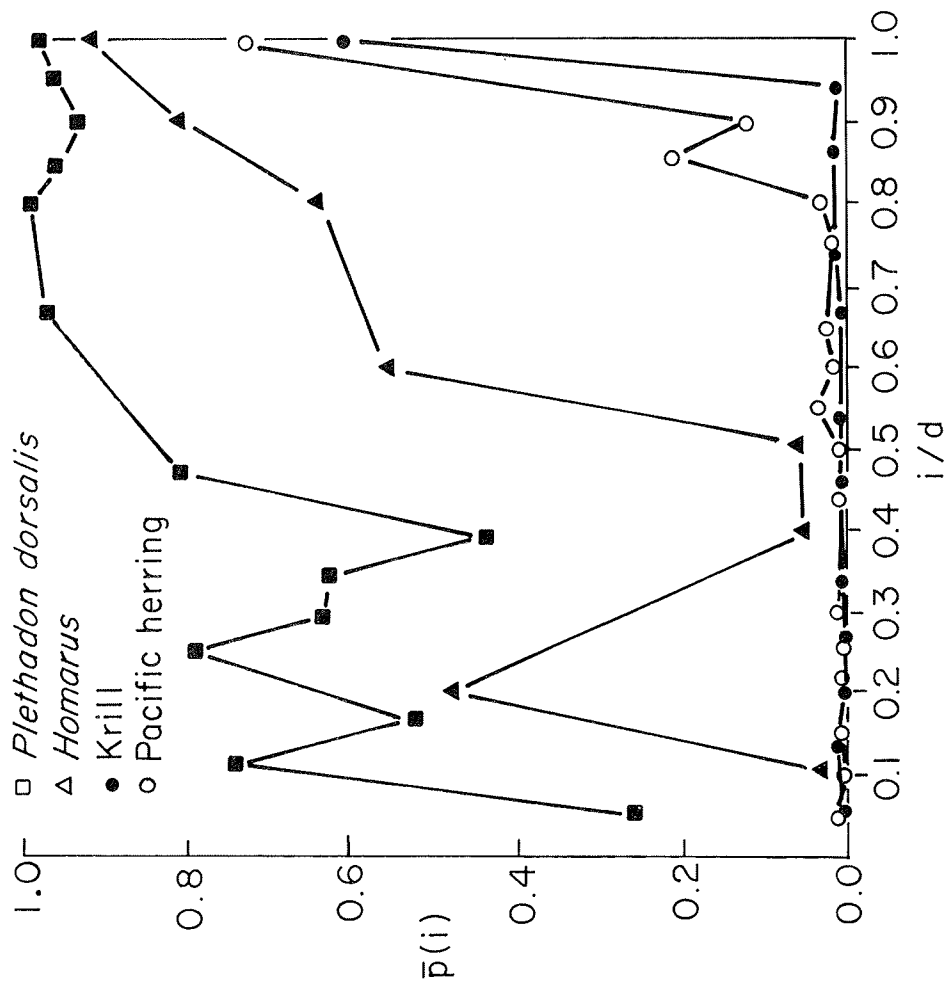

Fig. 2 Gene-flow analyses of four organisms having different amounts of migration between populations. See text for explanation of symbols.

$$F_{ST} = 1/(4Nm + 1)$$

where N is the population size, assumed to be equal in all populations, and m is the proportion of randomly drawn individuals migrating between populations each generation. Nm is simply the number of migrants, and the results are independent of population size. F_{ST} can be estimated from allele-frequency data using (Wright 1943)

$$F_{ST} = \frac{\sigma_p^2}{\bar{p}(1 - \bar{p})}$$

where σ_p^2 is the observed variance among populations for an allele having an average frequency over all populations of \bar{p} , and $\bar{p}(1 - \bar{p})$ is the expected binomial variance for a set of populations each fixed for different alleles. Using these equations and the allele-frequency data of Fevolden and Ayala (1981), and Schneppenheim and MacDonald (unpublished), estimates of F_{ST} are 0.017 and 0.001, and 15 and 187 migrants are needed to account for the levels of divergence observed in these studies.

Causes of genetic subdivision

We have seen in the previous section that krill and pelagic fishes in general are characterized by large amounts of gene flow between populations which tend to prevent local divergence. Nonetheless, genetic subdivision has been observed in some pelagic fishes, and it is the objective of this section to explore the possible causes of genetic subdivision in these species.

The mechanisms producing subdivision among populations can be viewed as being at one end of a continuum of events leading to speciation. From a population genetic point of view there are two basic modes of speciation, transience and divergence (Templeton 1980, 1981). The first mode is characterized by the formation of genetic discontinuity due to the genetic insta-

bility of an intermediate form, for example, a chromosomal rearrangement that greatly lowers the fitness of heterozygote carriers. This mode of speciation is probably rare, and population differentiation through some form of divergence is probably more prevalent in pelagic species. There are three kinds of divergence, each associated with a different regime of gene flow and selection. Habitat divergence occurs as a result of selection over sympatric habitats, whereas clinal divergence results from selection over a cline coupled with isolation by distance. Adaptive divergence occurs when populations are divided by some extrinsic physical barrier to gene flow such that the divided populations evolve independently. In each of these cases electrophoretically-detectable variants are assumed to be neutral or nearly-neutral markers of populational events and not the genetic material under selection (Lewontin 1974). Habitat divergence is probably not important in krill because it is difficult to imagine that populations of krill occupy different sympatric habitats in the pelagic ecosystem. Likewise, clinal divergence is also unlikely to be of importance among krill populations because of the extensive gene flow between populations. Allele-frequency clines have generally not been observed in pelagic species.

Thus, if genetic subdivision is found in krill, it will most likely be the result of adaptive divergence following the imposition of some physical barrier to migration. The barrier may no longer be in place, and the observed genetic groups may actually be converging through reassociation rather than diverging. The racial subdivision in Pacific herring appears to be an example of this process. Two previously undescribed races of Pacific herring were detected using protein electrophoresis (Grant in press b), where populations within each race were genetically homogeneous and where a hybrid zone existed between the races of the Alaska Peninsula. The length of time since divergence between the races began can be estimated using the genetic distance between them (Sarich 1977), and this estimate coincides with a period of extensive

coastal glaciation in the north central Pacific Ocean. Pacific herring would be particularly susceptible to coastal glaciation because they spawn intertidally or in very shallow water.

The effects of ancient barrier events are not quickly lost in pelagic species because of their extremely large population sizes. Sizes of spawning stocks are frequently on the order of millions of tons, which may represent as many as 10^{10} individuals (e.g. Atlantic herring, Iles and Sinclair 1982). The slowness with which genetic change proceeds in such large populations can be seen in the average time to fixation for neutral mutations, $4N_e$ generations (Nei 1975), where N_e is the effective population size. Thus, the time needed to reach equilibrium allele frequencies following reassociation after divergence may be thousands or even millions of generations. If future studies show that krill are genetically subdivided, the explanation for this structure may well be associated with a past geologic event that at one time prevented gene flow between populations.

Recommendations for future studies

A large number of polymorphic loci should be examined to provide a statistically sufficient description of the genetic population structure of krill. This requirement appears to be satisfied by the large number of polymorphic enzyme systems that have already been described for krill. The examination of additional proteins is unlikely to change our view of krill genetics. Samples are best analysed in a single laboratory so that the data can be statistically analysed without having to account for possible differences between laboratories.

Secondly, sample sizes at each location should be sufficiently large to be able to detect low levels of genetic divergence. Sample sizes of at least 200 krill are adequate for this purpose. Finally, samples should be taken from the entire circumference of Antarctica in any future study. The results of previous studies and the results of studies of other

pelagic organisms suggest that if genetic subdivision exists among krill populations, it is on a larger geographic scale that has so far been examined.

Acknowledgements

The author gratefully acknowledges Drs. R. Schneppenheim and M. MacDonald for sharing unpublished krill data for use in this paper. Travel to the symposium was provided by the Council for Scientific and Industrial Research, Pretoria, South Africa.

References

- Allendorf FW, Phelps SR (1981) Use of allelic frequencies to describe population structure. *Can J Fish Aquat Sci* 38:1507-1514
- Allendorf FW, Utter FM (1979) Population genetics. In: Hoar WS, Randall DJ, Brett R (eds) *Fish physiology*. Academic Press, New York. vol 8, pp 407-454
- Aspinwall N (1974) Genetic analysis of North American populations of pink salmon (*Oncorhynchus gorbuscha*), possible evidence for the neutral mutation-random drift hypothesis. *Evolution* 28:295-305
- Awise JC, Lansman RA, Shade RO (1979) The use of restriction endonucleases to measure mtDNA sequence relatedness in natural populations. I. Population structure and evolution in the genus *Peromyscus*. *Genetics* 92:279-295
- Ayala FJ, Valentine JW, Zumwalt GS (1975) An electrophoretic study of the Antarctic zooplankter *Euphausia superba*. *Limnol Oceanogr* 20:635-640
- Campton DE (1981) Genetic structure of sea-run cutthroat trout (*Salmo clarki clarki*) populations in the Puget Sound Area. M Sc Thesis Univ Washington, Seattle
- Chakraborty R (1980) Gene diversity analysis in nested subdivided populations. *Genetics* 96:721-723
- Chakraborty R, Fuerst PA, Nei N (1978) Statistical studies on protein polymorphism in natural populations. II. Gene differentiation between populations. *Genetics* 88:367-390
- Crow JF, Kimura M (1970) An introduction to population genetics theory. Harper and Row, New York

- Darnall DW, Klotz IM (1975) Subunit constitution of proteins: A table. Arch Biochem Biophys 166:651-682
- Fairbairn DJ, Roff DA (1980) Testing genetic models of isoenzyme variability without breeding data: Can we depend on the X^2 ? Can J Fish Aquat Sci 37:1149-1159
- Fevolden SE, Ayala FJ (1981) Enzyme polymorphism in Antarctic krill (Euphausiacea): Genetic variation between populations and species. Sarsia 66:167-181
- Fuerst PA, Chakraborty R, Nei M (1977) Statistical studies on protein polymorphism in natural populations. I. Distribution of single locus heterozygosity. Genetics 86:455-483
- Grant WS (in press a) Biochemical population genetics of Atlantic herring, Clupea harengus. Copeia
- Grant WS (in press b) Biochemical population genetics of Pacific herring (Clupea pallasii). Can J Fish Aquat Sci
- Grant WS, Zhang CI, Kobayashi T (in prep) Biochemical population genetics of Pacific cod (Gadus macrocephalus).
- Hedgecock D, Nelson K, Simons J, Shleser R (1977) Genetic similarity of American and European species of the lobster Homarus. Biol. Bull 152:41-50
- Ihssen PE, Evans DO, Christie WJ, Reckahn JA, DesJardine RL (1981) Life history, morphology, and electrophoretic characters of five allopatric stocks of lake whitefish (Coregonus clupeaformis) in the Great Lakes Region. Can J Fish Aquat Sci 38:1790-1807
- Iles TD, Sinclair M (1982) Atlantic herring: stock discreteness and abundance. Science 215:627-633
- Kimura M, Ohta T (1974) On some principles governing molecular evolution. Proc Nat Acad Sci USA 71:2848-2852
- King MC, Wilson AC (1975) Evolution at two levels: molecular similarities and biological differences between humans and chimpanzees. Science 188:107-116
- Lewontin RC (1974) The genetic basis of evolutionary change. Columbia Univ Press, New York
- Maruyama R, Kimura M (1974) Geographic uniformity of selectively neutral polymorphisms. Nature (Lond) 249:30-32
- Nei M (1972) Genetic distance between populations. Am Nat 106:283-292
- Nei M (1973) Analysis of gene diversity in subdivided populations. Proc Nat Acad Sci (USA) 70:3321-3323

- Nei M (1975) Molecular population genetics and evolution. Am Elsevier, New York
- Nei M, Roychoudhury AK (1974) Sampling variances of heterozygosity and genetic distance. *Genetics* 76:379-390
- Sarich VM (1977) Rates, sample sizes, and the neutrality hypothesis for electrophoresis in evolutionary studies. *Nature (Lond)* 265:24-28
- Shaklee JB, Whitt GS (1981) Lactate dehydrogenase isoenzymes of gadiform fishes: Divergent patterns of gene expression indicate a heterogeneous taxon. *Copeia* 1981:563-578
- Slatkin M (1981) Estimating levels of gene flow in natural populations. *Genetics* 99:323-335
- Somero GN, Soulé (1974) Genetic variation in marine fishes as a test of the niche-variation hypothesis. *Nature (Lond)* 249:670-672
- Templeton AR (1980) Modes of speciation and inferences based on genetic distances. *Evolution* 34:719-729
- Templeton AR (1981) Mechanisms of speciation - A population genetic approach. *Ann Rev Syst* 12:23-48
- Tracey ML, Nelson K, Hedgecock, Shleser RA, Pressick ML (1975) Biochemical genetics of lobsters: genetic variation and the structure of American lobster (Homarus americanus) populations. *J Fish Res Bd Can* 32:2091-2101
- Valentine JW, Ayala FJ (1974) Genetic variability in krill. *Proc Nat Acad Sci (USA)* 73:658-660
- Vrooman AM, Paloma PA, Zweifel JR (1981) Electrophoretic morphometric and meristic studies of subpopulations of northern anchovy, Engraulis mordax. *Calif Fish Game* 67:39-51
- Wright S (1943) Isolation by distance. *Genetics* 28:114-138
- Wright S (1969) Evolution and genetics of populations. Vol II The theory of gene frequencies. Univ Chicago Press, Chicago

ANALYTICAL EVALUATION OF TECHNICAL RMT1+8 TOW DATA

by

Tilman Pommeranz

Abstract

The paper presents methods, by which the technical data of RMT1+8 tows can be evaluated analytically, i.e. by taking the differences between the dependences of the effective mouth angles (θ_f) on the speed of the nets through the water (V) and different θ_f at different V during two phases into account. This is accompanied by suggestions on how the results of this could generally be presented and supplemented in order to supply taxonomists with satisfactory technical RMT1+8 tow information.

SOME PROBLEMS IN MODELLING THE DYNAMICS OF KRILL

by

John R. Beddington

Abstract

The information on the response of krill to exploitation typically obtained by a commercial fishery are reviewed. The possibility of using such data to model the population dynamics of krill are discussed. It is concluded that unless a major fishery develops, information will accumulate in the foreseeable future at too slow a rate for an assessment to be made of the potential yield of krill using traditional methods.

An alternative approach is suggested in which the response of krill to the depletion of the baleen whales may be monitored by considering the demographic rates of the whales. These demographic rates may be considered as a rough approximation to a catch per unit of effort, this in itself should be related to krill abundance. Some simple models using this idea are developed and fitted.

SUMMARY OF THE DISCUSSIONS OF THE SUB-GROUP ON
DISTRIBUTION, STOCK IDENTITY AND POPULATION MODELS

Chairman: I. Everson

Rapporteur: C.M. MacDonald

Present: T. Antezana, J.R. Beddington, I. Everson,
W.St. Grant, O. Guzman, U. Kils, T.G. Lubimova,
C.M. MacDonald, F. Nast, T. Nemoto, T. Pommeranz,
R. Schneppenheim, V. Siegel, A. Tomo

The group discussed the various papers in major themes in an attempt to provide answers to particular questions.

I. Geographical Distribution

The first question considered was that of:

What are the key factors controlling abundance in a given geographic area within a season?

It was generally agreed that mixing zones were frequently regions of high krill abundance. Examples quoted included Bransfield Strait, Weddell/Scotia Confluence, Prydz Bay. Discussion then centred on how and why the krill should be concentrated in such areas. The early life history stages, with their limited ability to move fast are almost certainly carried passively whilst juveniles, being more active swimmers may be able to move with some effect against ocean currents. Adults are thought quite able to move independently of the main water circulation. Thus the ability to remain in a region as a result of their own activity increased with size. Nevertheless since large concentrations of all life history stages are encountered it was felt that both, active and passive mechanisms probably applied.

The one factor thought likely to encourage active concentration by krill was that of food. Food concentration did not, however, correlate well with krill abundance probably as a result of the time between sampling the concentration and its formation.

This is indicated in the table below.

"New" krill concentration	phytoplankton conc. high as ungrazed
"Old" krill concentration	phytoplankton conc. low as grazed down

The important factor in this context was thought to be primary production rate and it was suggested that many areas of krill concentrations whilst containing low standing stocks of phytoplankton may nevertheless be highly productive. The turnover rate may itself be enhanced by ammonia production by the krill. The initial high primary production in the area was thought to be a direct result of mixing.

The ice edge zone was seen as being a particular example of such a productive zone. The water column in such regions was generally quite stable which in conjunction with seeding of the water with resting spores from the melting ice could account for this productivity. There was good evidence for occurrence of both larval and adult krill under the ice although their distribution and abundance there was not known. Krill caught from openings in freshly broken ice had been observed with full guts indicating they were actively feeding probably on the ice associated algae.

The above description based on the level of primary production being the dominant factor in controlling krill distribution does not take account of low primary productivity in winter. It was not known to what extent mixing

zones were important in winter although evidence from the Bransfield Strait region suggested that krill were still present in such areas. There was also evidence for feeding in winter although since the guts were white it was not possible to identify the food beyond noting it was not photosynthetic but possibly bacterial.

The second question addressed concerned determining the extent to which size classes were separated and if so why. There was good evidence that frequently different sizes of krill were present separately in closely adjacent localities. The reasons for this were not apparent although it was thought possible that differing swimming activities resulting from size could affect their ability to immigrate. There was some evidence for smaller krill being present in the shelf areas whilst larger krill tend to be offshore.

The third question addressed was that concerning year-to-year variation.

There is good evidence to suggest that there is considerable variation from year to year in local abundance. Such variation is of particular importance in the context of predator prey interactions. No information was available on which to base realistic quantitative assessments.

The subject could be investigated by a series of annual large scale surveys but the cost of such a venture would be prohibitive. An alternative approach would be to note the distribution of fishing vessels by month in each season. Such a pattern would indicate clearly where the krill are abundant although not necessarily where they are scarce.

A further question concerning distribution on a large geographic scale was the breeding structure of krill populations. The group agreed that existing electro-

phoretic data indicated a single interbreeding population from the Antarctic Peninsula throughout the Scotia Sea and eastwards as far as the Prydz Bay region. However, some contradictory data in the area of Anvers Island and the lack of any data for the eastern Indian Ocean sector, the Pacific Ocean sector and the Bellingshausen Sea proper highlighted the need for further sampling on a large geographic scale and repeatedly in selected areas over two or more seasons.

Although the existing data indicate a single interbreeding population of krill the group felt that there is still a need to collect information on absolute abundance and size composition of krill over large geographic areas to determine whether or not environmentally mediated variation in growth and mortality occurs, i.e. is mixing sufficiently restricted at times to allow the formation of stocks with distinct population dynamics. Other information which may be of use in this respect includes oceanographic data and observations on predator distributions and behaviour.

II. Small Scale Distribution of Krill

Although observations on the aggregation or swarming of krill are now numerous, the key environmental and/or behavioural factors influencing this phenomenon are still not clear.

The group accepted that diurnal vertical migrations are an important part of the swarm formation process, but other factors which might also play some role are:

- sex, size, moult state, biochemical composition
- season
- distribution and abundance of food,
- physical oceanographic characteristics e.g. prevailing

cyclonic gyres, light, depth of mixed layer, temperature
predator avoidance behaviour.

It was noted that swarming was not an effective predator avoidance mechanism in the case of large predators such as baleen whales.

It was suggested that perhaps the best way to distinguish the relative importance of the above mentioned factors in determining swarming behaviour was to look at all available data on size and distribution of swarms and try to correlate this data with concomitant data on depth, phytoplankton measures, time of day or night and any available hydrographic data.

It was suggested that future studies of the swarming behaviour of krill should be approached by developing and testing hypotheses which specify the advantages of swarming for krill.

The behaviour of individual krill within a single swarm is still not clear. The working group identified the following questions or hypotheses concerning behaviour within swarms:

- a) Can and do swarms form with no active swimming contribution by krill, or with no directed swimming by krill?
- b) To what extent do krill orient with respect to each other?
- c) To what extent do krill maintain spaces between each other?
- d) To what extent do individual krill maintain their position in a swarm (e.g. in the centre or on the edge)?
- e) Is swarming associated with feeding activities?

- f) What are the swimming speeds (if any) of swarms of various sizes?
- g) At what size do krill begin to swarm?
- h) To what extent does swarming by sex or reproductive state occur?
- i) What interactions are there between swarming krill and other zooplankters?

Sampling Methods

The working group was aware of an urgent need to attempt to standardize sampling techniques and data formats for future work on krill. It was noted that many such recommendations had been included in the report of the post-FIBEX Data Workshop and the group strongly urged that these points be re-emphasized when considering SIBEX activities.

Specific comments to arise out of the group's discussion on standardisation of sampling methods included:

- a) Length Measurements
It should be noted whether krill are measured fresh or preserved. Furthermore, the exact method of measuring (e.g. tip of telson to tip of rostrum) should be specified when presenting data.
- b) Stages of Sexual Maturity
Already under consideration by another specialist working group and not considered here.
- c) Catching or Sampling of Krill
Gear used for scientific (rather than commercial) collecting of krill to be specified by including information on gear type, dimensions, mesh size, towing speed, volume of water filtered per unit time, net mouth dimensions and depth track of haul.

The group also strongly recommended that intercalibration data on gear to be used by various SIBEX participants be obtained if possible prior to the start of SIBEX collecting activities.

d) Flowmeters

The collection of flow meter recordings to be strongly urged for SIBEX.

e) Samples of Krill

Sample weights and krill numbers to be reported at all times. If a catch consists of other species besides krill then the same procedure should apply to each species if possible.

f) Collection of Krill for Population Genetic Studies

Samples of 200 to 250 krill should be collected from each collecting location. Krill should be rinsed in cold deionised water (or fresh water) and excess water removed by blotting with paper towels. Specimens should be frozen individually (not in a block). Preferably by placing single layers of krill between plastic sheets and placing these in air tight plastic bags. Specimens should be frozen immediately and kept frozen at -70°C if possible. If an ultra cold freezer is not available then a freezer of at least -20°C capacity should be used. Information on collection location (latitude, longitude) collection date, station or hand number and vessel should be written on paper and placed in each sample bag. A separate list of samples collected should also be maintained.

g) Acoustic Recordings

The group recommended that all acoustic recordings of krill abundance be presented as units of mean volume back scattering strength.

- h) Krill Sample Sizes for Length Frequency Data
At least 200 specimens per haul (HAUL), but empirically derived a priori sampling requirements need to be determined.

- i) Minimum Detection Level for Acoustic Studies of Krill
To be referred to another Working Party (Acoustic Estimation W.P.) for consideration.

- j) Estimates of Surface Abundance of Krill
Can be done with forward mounted surface sampling nets and upward-facing transducers, but the feasibility of these techniques is as yet unproven. The group suggested that the polar research community be approached for ideas or proposals to facilitate this type of work.

Predator/Prey - Interactions

- a) Whales. The group noted that extensive information has been collected by various nations on the distribution and abundance of whales during commercial operations, but that in some cases such data was not readily available. The group was informed that whale observers would be placed on some Japanese vessels during SIBEX activities and that observations on distribution and abundance would be compiled afterwards.

The group recommended that data of special interest to krill biologists (e.g. stomach contents - both total volume, and size composition of krill) be requested from workers on other Antarctic predators (whales, seals, birds, fishes etc.), particularly during SIBEX. It was noted that substantial data on whales collected by the USSR and Japan during FIBEX

remained unavailable and the group recommended that this data be analysed if possible.

- b) Fish. The group was informed that in general not many fish were found in nets used to catch krill in oceanic pelagic environments, but in shelf waters there are many types of demersal and epibenthic fishes found in krill hauls. The group noted that for SIBEX some organizations are already planning to study physical oceanography/krill/fish interactions, particularly in the Antarctic Peninsula region.

Seals. Little information was available although studies were in progress on Crabeater seal in the pack ice zone (USA) and Furseal at South Georgia (BAS).

Cephalopods. Direct sampling of squid and other cephalopods in Antarctic waters is very difficult. It might be possible to make an indirect analysis of the importance of squid as krill predators by measuring stomach contents of sperms whales and attempting to infer squid distribution and abundance from this. Some analyses of this nature are already underway in UK.

It was also suggested that information on krill predators which might be obtained from by-catches on commercial krill fishing vessels might also be useful for estimating distribution and abundance, and that the possibility of obtaining such data should be investigated.

General. As an alternative to large scale geographical sampling of krill predators it was suggested that studies of localised predator impact be made by doing sequential sampling of krill in a single area

close to local concentrations of predators. Some work of this type is already underway or proposed (US and UK work).

Modeling of Krill Population Dynamics

Modeling can be done on two major time scales

- a) Models of within-year fluctuations of krill populations,
- b) Models of year-to-year variations in krill populations.

- a) Within-year fluctuations

The type of information needed for modeling krill population dynamics on this scale is essentially sequential sampling of life history stages of krill over in a single area, together with estimates of absolute abundance and relative abundance of size classes. The area chosen should preferably be in waters where oceanographic situation is not too complex, so that the chances of sampling a single stock throughout the year is maximised. Quantitative sampling of eggs is also desirable if possible to determine fecundity levels. The best data: likely to be obtained by trying to follow and sequentially sample a single patch of krill in a localized area. It was noted that under these circumstances population fluctuations within a year would be due to migration, growth and/or mortality of krill. Predator consumption/or fishing estimates are needed, and indeed the choice of areas for this exercise might be made on the basis of the availability of such estimates.

- b) Year-to-Year variation in distribution and abundance

To model fluctuations on this time scale sampling must be carried out on a broad geographical scale and over many years in order to calculate mean

values for various population parameters. Again absolute abundance estimates are required as well as relative abundance of size classes. Catch rates from commercial krill fleets will also help to indicate fluctuations in krill population parameters, but independent estimates based on data collected from scientific sampling of unexploited stocks will provide a good basis for calibrating these catch rates with estimates of absolute abundance. The group noted that valuable information on distribution of krill concentrations has been collected by the USSR and other krill fishing nations and it is hoped that such information could be made available in the near future for modeling purposes.

The group was informed that once models of krill population dynamics had been developed more of the same type of data described above would be needed to test these models.

In this context it was noted that in future where different catching techniques are used intercalibration of gear used should be carried out in order to standardize the catch data obtained. Published data should specify the catching method used (see notes in sampling methods).

The group recommended that Drs. Everson and Beddington investigate the statistical problems associated with intercalibration of gear, and that the results of this study be used initially to calibrate recorded catches from the older Discovery nets with the currently used RMT nets. In this way the extensive data obtained with the Discovery nets could be comparable with the recent data.

SUMMARY OF THE DISCUSSIONS ON PLANS FOR SIBEX
IN THE SOUTH-WEST ATLANTIC SECTOR
AND OF THE DISCUSSIONS OF THE VARIOUS SUB-GROUPS

Chairman: G. Hempel
Rapporteur: A. Clarke

Discussions of SIBEX proposals opened with a request from Dr. Tomo (Argentina) for details of the krill research each country planned to undertake in the future. These were provided by representatives from Argentina, Australia, Chile, France, Federal Republic of Germany, Japan, Poland, South Africa, Sweden, United Kingdom, USA and USSR, and on behalf of Brazil and Norway. A head-count revealed a total of about 290 scientists working on krill, two-thirds of whom were located in the USSR alone.

Discussions of SIBEX proper were started by Professor Rakusa-Suszczewski (Poland) who described a proposal for a multi-ship project in the Bransfield Strait area. Two areas were designated, the major area A in the Bransfield Strait and the minor area B running parallel but to the Drake Passage side of the South Shetland Islands. There would be 7 obligatory transects within area A, and 4 within B, each of which would include 2 stations in deep water, 1 over the shelf-break and 1 over the shelf. The minimum requirements at each station would be:

- i. temperature and salinity measurements to 500 m (or to the bottom if a CTD/STD used)
- ii. plant cell and chlorophyll measurements
- iii. net hauls for adult krill (RMT 8 or Bongo), and also for larval krill, other zooplankton and ichthyoplankton (Bongo)

- iv. preservation of krill samples for biochemical studies of stock identification and krill ageing
- v. hydroacoustic, meteorological and bird observations.

Professor Hempel emphasised that the main aims of SIBEX were an attempt to relate krill distribution (both adults and larvae) to water masses, an attempt to follow separate cohorts over a season, and to follow the large scale movement of krill swarms or patches. Realistic ship times were likely to be:

	obligatory work only	including deep larval tows, deep STD casts or bottom trawls
area A	6.5 days	7-8 days
area B	4 days	5-6 days
total (A+B)		about <u>13 days</u>

Including the coverage of the 2 extra strips in area B would add about 4 days, the 2 rectangles in area A about 5 days, and the 4 polygons for intensive sampling of fish and krill larvae about 8 days. Total SIBEX work (obligatory plus voluntary but excluding bottom trawls) would thus come to 30 days ship time, perhaps 6 weeks when allowance is made for passage to and from the area from port, and bad weather.

Although areas A and B do not cover the complete area where early krill larvae might be found, there was nothing to prevent vessels undertaking work outside these areas but only vessels completing the obligatory transects would be considered SIBEX vessels. Recent results from the second post-FIBEX hydrography workshop indicated that northward flowing Bellingshausen water passed on both sides of the South Shetland Islands, but that there was also a southward flow of Weddell Sea water close to the Antarctic Peninsula. There were indications of a small eddy or gyre towards the top of the

Antarctic Peninsula. These data indicate the need for T/S drops to go all the way to the bottom, and for station details to include bottom topography (preferably a sounding).

Subsequent discussion revealed overall agreement over both the aims and the general outline of these proposals for SIBEX. Time was passing and it would soon be necessary for final details to be agreed with the relevant chief scientists; unfortunately neither Argentina nor USSR could indicate whether they would actually take part in SIBEX. There were no other dissenters.

Before the meeting closed for the day, Professor Sahrhage raised the point that many countries also require to work on fish both the demersal adults and larvae, and emphasized that this involved a commitment of time.

The second day's discussion opened with brief descriptions of SIBEX work planned for the Prydz Bay area and the Pacific Sector. Australian work will concentrate on defining the hydrography of Prydz Bay, where there is evidence of a clockwise gyre, and relating this to zooplankton. In particular there will be studies of larval krill, to determine whether the krill population in Prydz Bay is self-staining. Japanese work in the Pacific Sector will involve 8 transects, concentrating particularly in the Antarctic Convergence and the Antarctic Divergence areas.

The reports of the various sub-groups were then discussed. First Professor George presented the conclusions of the sub-group on early life history. The major recommendations were for sediment traps to be deployed in order to obtain better samples of krill eggs, for a study of biochemical aspects of krill development (particularly in relation to developmental ascent and descent), and a detailed study of the feeding physiology of the furcilia stages especially the later stages as winter started. The consequent general discussion

highlighted also the need to link larval catch data with hydrographic conditions, and the importance of some understanding of fluctuations in larval production.

The physiology sub-group (chaired by Professor Rakusa-Suszczewski) had concluded that at the moment physiological and biochemical data was patchy and of variable quality, particularly with respect to energetics. Some age data was obviously badly needed (and here Ettershank's proposed method using age-pigments looked useful, and should be fully investigated), oxygen consumption values were largely routine and hence very difficult to incorporate into energetic calculations, and there were too few data on nitrogen excretion and none on CO₂ production. Discussions had highlighted the importance of measuring assimilation efficiency in relation to food concentration and it was recommended that acute temperature studies be avoided in favour of studies of krill from different geographical areas. The major recommendation, however, was that the best approach for obtaining meaningful data on krill physiology was a multi-investigator project, based in a shore laboratory, where most of the important physiological parameters could be measured together. This was accepted, and passed to the BIOMASS Krill Ecology Working Group for detailed discussion. Any such project should not be viewed as part of SIBEX.

The discussions of the third sub-group, on general krill biology, were summarised by the chairman Dr. Everson. A major conclusion to emerge was that primary production seemed to be low when considering the biomass of consumers. It would be better if krill distribution were related to productivity rather than chlorophyll standing stock, and also that productivity be size-fractionated so that the amount available to larval stages was known. Monitoring krill local abundance through the breeding success of higher predators was considered a valuable technique. A discussion of attempts to calculate fishing pressure on krill off Elephant Island through

changes in length-frequency distribution highlighted once more the importance of establishing the wide-scale value of age-pigments in determining the growth rates of krill.

Conclusions

A discussion of techniques indicated that most investigators were using either Bongo or RMT 8 nets for sampling krill, but there was a very great need for inter-net calibration. These would be particularly valuable if Discovery N-100 nets could be included, so that the important Discovery data could be re-analysed.

The concluding discussion emphasised that SIBEX transects were at right angles to prevailing currents, and that details of more intensive studies would be decided by a meeting of chief scientists. No date was fixed for this.

Other conclusions were that there is far more valuable krill information in the FIBEX data than has so far been published, and it was important to extract this, and that a co-operative experimental study of krill physiology was an important new element within BIOMASS with great potential.

KRILL BIOLOGY AND FIBEX: SOME PROBLEMS OF CO-OPERATIVE
DATA ANALYSIS RELEVANT TO THE PLANNING OF SIBEX

by
Denzil G.M. Miller

Summary

Some of the problems encountered during the co-operative analysis of krill biology data during FIBEX are reconsidered. A set of simple data queries are described in an attempt to assist planning and analyses of SIBEX results.

Introduction

Both the BIOMASS* Scientific Advisory Group for SIBEX-1 (BIOMASS Rept. Ser. No. 23) and the Technical Group for Programme Implementation and Co-ordination (BIOMASS Rept. Ser. No. 29) have emphasised that SIBEX should be aimed at understanding the key processes of the Antarctic marine ecosystem in greater depth. As a result, it should not merely attempt another multi-ship estimate of krill abundance (as in FIBEX) but should rather concentrate on the study of meso-scale processes. Research questions should thus be answered definitively by the work done and there must be a clear understanding of the study's primary objectives.

It is not intended to emulate or expand the original SIBEX key questions identified at Nikko and considered in some detail in BIOMASS Rept. Ser. No. 29. Nevertheless, as SIBEX rapidly approaches, some of the lessons learned at the Post-FIBEX Data

* The following acronyms have been used throughout the text:
BIOMASS - Biological Investigations of Marine Antarctic
 Systems and Stocks
FIBEX - First International BIOMASS Experiment
SIBEX - Second International BIOMASS Experiment

Interpretation Workshop in Hamburg should be reconsidered (BIOMASS Rept. Ser. No. 20). In particular, cognisance must be taken of problems encountered in both data collection and in the inadequate standardisation of parameters for comparative analyses. It is also apparent that at Hamburg analysis of FIBEX krill biology data was hampered by a lack of clarity in the primary objectives being addressed (BIOMASS Rept. Ser. No. 25).

SIBEX, being both a multi-ship and multi-year exercise, will be especially susceptible to inadequate data standardisation. Being a process orientated survey, particular attention must be given to the phenomena being investigated and great care must be taken to formulate both comprehensive and realistic key questions. I hope that this document will not only resurrect some of the problems encountered in Hamburg but that it will also serve a useful purpose to the BIOMASS Working Groups on which the responsibility for the planning of SIBEX has fallen.

Problems of data collection and standardisation in the co-operative analysis of krill biological data

As already stressed, inadequate data standardisation severely hindered analysis of krill biology data in Hamburg (BIOMASS Rept. Ser. No. 20). More specifically, incomparable methods of data collection, variability in sample processing and incompatible measurements of important biological parameters precluded sensible co-operative analyses of results. Inadequate standardisation procedures were clearly illustrated in the following:

- the use of various nets and the employment of a variety of fishing methods during acoustic target sampling;
- a lack of standardisation in the processing of net samples (i.e. sample count, weight or biomass were not separated and no single parameter was prescribed which often resulted in a variety of unrelated attributes being recorded);

- an incomplete definition of the important biodata to be measured (particularly body length and sexual maturity stage). This was compounded by the use of an incorrect analysis procedure for the computation of comparable length frequency distributions from samples of various sizes (see Appendix 1). Since SIBEX is likely to expand FIBEX study horizons, problems of inadequate data standardisation will be magnified; particularly with the addition of new research topics. These will probably comprise assessments of krill larval development/distribution and attempts to outline trophodynamic relationships between krill and other zooplankton species.

Problems of adequate standardisation must be tackled prior to the collection of SIBEX data. This will not only eliminate accrual of redundant information but should also avoid confusion. In addition, a clear definition of the ultimate objectives and key questions to be addressed during SIBEX must be forthcoming. The data collected by the participants must not only be comparable, but if SIBEX is to be a truly co-operative study then the desired analyses of results must also be clearly outlined.

SIBEX objectives and some questions which may be put to data collected

To date, SIBEX objectives have only been broadly defined. (See especially BIOMASS Rept. Ser. No. 29.) During initial planning generalities are essential, but let it not be forgotten that the first phase of SIBEX is not only eight months away. The time has come to think very carefully about data collection and analysis. To reiterate what has already been stressed, methods of data collection must be standardised and comparable analyses methods selected. The following series of query examples are included in an attempt to demonstrate the type and scope of analyses possible on krill biology data likely to be collected during SIBEX. The Hamburg Database system format

(BIOMASS Handbook No. 16) is used and it is assumed that the same or a similar facility will be utilised for data consolidation.

The analyses assess variations in abundance, biomass, population structure and body length of krill. Both spatial and temporal variability should be considered in order to estimate effects of seasonal variation on these parameters. As a result the analyses become complex requiring that the data be grouped geographically and by season (if this should vary from region to region or between periods of study). In addition, some data may have to undergo transformation to facilitate their full interrogation.

The overall analysis schema is summarised in Fig. 1. In a stepwise manner the analyses give:

- (a).- a plot of the area surveyed. Information for this is retrieved from net haul data (Hamburg format BO5A);
- (b).- a division of the area into sectors (say one degree by one degree) which are uniquely numbered and in which station/haul positions are consolidated into a composite plot. This gives a grid of the whole survey area with net stations grouped in demarcated sectors;
- (c).- an interrogation of data collected by various sampling devices. Use is made of data in BO6A of the Hamburg database while the samplers must be comprehensively defined and uniquely labelled if data retrieval is to be adequate;
- (d).- a calculation of the mean number of animals (count) captured at each station and by the various nets. This can then be divided into a figure for catches taken by day (between local sunrise and sunset) and by night. As no specific algorithm was available for the calculation of local sunrise/sunset in the Hamburg system, this would have to be introduced. Having obtained values for mean day or night catches, these must be standardised for comparative purposes (i.e. for differences in net

BLOCK

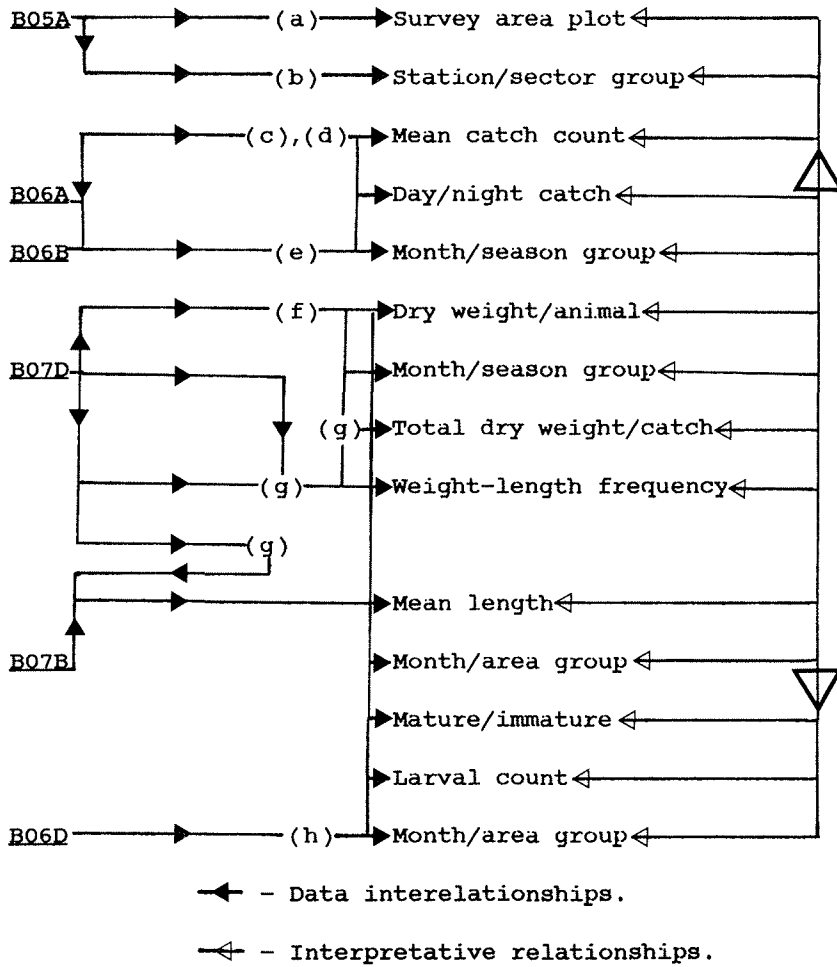

Fig. 1 A data analysis schema for SIBEX. [For description of data analyses - see text. Data is in the Hamburg Database format (BIOMASS Handbook No. 16)].

size or fishing time etc.) and tested statistically for differences in mean catch with time of day (see suggested statistical analysis method in Appendix 2). A similar analysis could be designed to interrogate acoustic data for differences in day/night mean back-scattering volumes;

- (e).- an extension of the previous analysis to calculate mean monthly or seasonal catches in different survey areas. This could be further extended to include day/night differences. Data collected during SIBEX may not be comprehensive enough to include such analyses, but it is at least worthwhile considering. The calculation procedure for both this and query (d) would be essentially the same. Catch count (B06B) is interrogated haul by haul with respect to time/season/month (B05A) in a particular area or sector. Haul results can then be grouped and mean values calculated. It is essential that the number of hauls by each net in a particular area be included in the final result so as to give at least some idea of survey cover. Catch counts can be of Euphausia superba only or of any other selected zooplankton group. Larval counts should also be included (a method for larval count analyses is discussed later);
- (f).- a conversion of the body length (adequately standardised) of all juvenile and adult animals into dry weight, the following equation (after Clarke 1976) could be used:

$$\text{Log}(W + 2.27) = 3.35\text{Log}L - 3.318 \quad (1)$$

or:

$$W = 10^{(3.35\text{Log}L - 3.318)} - 2.27 \quad (2)$$

where:

W = dry weight in mgs;

L = total body length ("Discovery measurement").

A calculation of this type should be carried out for each animal in catches where length frequency distributions are available (B07D). The dry weight/animal can then be summed to give a total catch dry weight (TW). Again, and in turn, this is summed by area. It is possible that some catches will be subsampled prior to the construction of length frequency distributions. In these cases it is essential that the necessary arithmetic should convert distributions to a proportionate total catch value. As such, care must be taken to ensure that length/weight distributions are corrected for variations in sample size (see Appendix 1);

- (g).- a mean body length value for animals caught. The mean should be calculated with one standard deviation and by using the proposed methods for sample size correction. This analysis could be extended to include mean body length calculations for animals at various stages of sexual maturity. It combines data from B07B and B07D and can be expanded to include larval data;
- (h).- a calculation of the number of eggs and larvae caught by area and time. The analysis procedure is the same as already described for post-larval animals but the data to be considered is available in B06D only (this was not accessible to all the Hamburg workshop participants, being part of the "Discovery" data set). It may also be easier to group larvae in broad classification (i.e. calytopes, furciliae etc.) rather than by specific developmental stages (i.e. calytopis I etc.);
- (i).- a series of plots consolidating the procedures so far described and presenting them in a relatively simple and concise manner. The following plots could be obtained:
 - [a]. Mean monthly/seasonal catch count for each net in a particular area;
 - [b]. Mean animal dry weight by area with respect to time or season. This would be a composite plot combining weight and count;

- [c]. Presents (b) but includes a TW plot for whole samples where only subsample length frequencies were constructed;
- [d]. Mean length (plus one standard deviation) with time and with respect to survey area;
- [e]. Repeats (d) but further subdivides data into animals with/without spermatophores (i.e. immature v's mature);
- [f]. Presents the number of larvae and eggs caught with respect to time and area.

(j).- a calculation of mean annual biomass (mg dry weight/m³) for all post-larval animals caught by respective nets in each area surveyed. The dry weight calculation is as outlined above and can be expanded to include proportionate length frequency distributions from subsamples. For each haul, biomass (B) is calculated from the formula:

$$B = \frac{TW}{WF} \quad (3)$$

where:

TW = total catch weight;

WF = volume of water filtered by net to obtain sample.

(N.B. WF must be made a compulsory parameter for inclusion in the haul data [B05A]).

A composite plot can then be presented for krill biomass by area, net and time;

(k).- an estimation of the predominant age class of animals collected in each area using published figures for krill age/length relationships (Mauchline 1980, 1981) in combination with length frequency distributions described above and presented in plot (i. [d]). Dependent on the success of this estimate it should be possible to calculate krill production/area from relationships given by Allen (1971) and Edmondson and Winberg (1971). Allen curves are constructed from the mean number of ani-

mals/m³ and the mean dry weights/generation of krill found in a particular area calculated. The annual mean production (mg dry weight/m³/yr) is the sum of the net production by all year classes sampled. As such, production estimates are a function of the mean life span (Allen 1971). Considerable controversy still surrounds the longevity of E. superba, but recent developments in age determination (Ettershank, this symposium) should alleviate the confusion with a subsequent increase in accuracy of production estimates. Having derived both production (P) and biomass (B) values, P:B ratios are calculable and maximum use can then be made of ancillary ecological information gathered (e.g. primary production rates or krill predator abundance) in an attempt to establish trophodynamic relationships between krill and other important groups.

The above example is only one of many analysis packages that could be addressed to data collected by SIBEX. Obvious extensions include the incorporation of more sophisticated correlations between specific krill biodata and physical or ecological parameters. These would certainly produce a better understanding of the processes affecting krill ecology and distribution.

Although it should be possible (and indeed desirable) to highlight important conditions affecting the distributional biology of E. superba, it is also likely that by their very nature they may obscure other significant effects. This must always be borne in mind when the results of SIBEX are finally consolidated. There is no substitute for knowing the data thoroughly and it is with this knowledge that analyses must be combined to reach valid conclusions. Only with adequate standardisation of data requirements can subsequent and co-operative analyses be worthwhile. In this regard, the recommendations arising from the Krill Biology Working Group at the Hamburg Workshop (BIOMASS Rept Ser. No. 20) should be

reconsidered. Finally, it must be stressed that the setting of unreasonable, or even worth incomplete, survey objectives must not erode the time or energy available for the sensible analyses of results. Now is the time to think about and set sensible SIBEX objectives.

References

- Allen KR (1971) Relation between production and biomass. J Fish Res Bd Can 28:1573-1581
- Clarke A (1976) Some observations on krill (Euphausia superba Dana) maintained alive in the laboratory. Br Antarct Surv Bull 43:111-118
- Edmondson WT, Winberg LL (1971) A manual of methods for the assessment of secondary production in fresh waters. Blackwell, Oxford. IBP Handbook No 17:386pp
- Mauchline J (1980) The biology of mysids and euphausiids. Adv Mar Biol 18:681pp
- Mauchline J (1981) Studies on patches of krill, Euphausia superba Dana. BIOMASS Handbook No 6

Author's address: D.G.M. Miller
Sea Fisheries Research Institute
Cape Town
South Africa

Appendix 1

Calculation of biodata frequency distributions independent of original sample size

For any subsample/sample of a number of animals (N), let the number of animals within a single biodatum (e.g. size class) be "ni". Then the proportion (Pi) of animals in the sample/subsample which are to be found in a single biodatum class (i) is given by the following expression:

$$\begin{aligned} P_i &= \frac{n_i}{\sum_{L=1}^M n_i} \\ &= \frac{n_i}{N_s} \end{aligned} \quad (1)$$

where:

N_s = total number of animals in sample/subsample;
 M = number of biodata classes for animals in sample.

The proportion of animals in the subsample/sample which are both in a particular biodatum class and which also possess some other biological characteristic (j) (e.g. maturity stage) is:

$$\begin{aligned} (P_i)_j &= \frac{(n_i)_j}{\sum_{j=1}^N \sum_{L=1}^{M_j} (n_i)_j} \\ &= \frac{(n_i)_j}{N_s} \end{aligned} \quad (2)$$

where:

M_j = number of biodata classes for animals with biological characteristics (j);
 N = number of biological characteristic stages (i.e. maturity stages);
 N_s = total number of animals in subsample/sample.

Appendix 2

A simple statistical procedure to assess differences between day and night net catches

The recommended procedure is based on that described by Lindley (1980). Differences between day and night catches are initially grouped and examined for each area with respect to month or season. For each month the data are examined using a series of Wilcoxon matched-pair, signed-ranks tests (Siegel 1956) or a similar non-parametric technique.

Monthly-grouped data provide potentially matched pairs by both area and/or season. These can then be examined statistically. A non-parametric method must be used as it is expected that monthly or grouped catch means will exhibit a highly skewed distribution with associated wide variance.

Consequently, results of a simple Student t-test are invalid since it cannot be assumed that the variables exhibit a normal distribution and approximately equal variance in paired data sets.

References

- Lindley JA (1980) Population dynamics and production of euphausiids II. Thysanoessa inermis and T. raschii in the North Sea and American coastal waters. Mar Biol 59:225-233
- Siegel S (1956) Non parametric statistics. McGraw-Hill, New York. 312pp

WORKING PARTY ON KRILL ECOLOGY
Report of First Meeting, 20 May 1983

Chairman: I. Everson

Present: A. Clarke, I. Hempel, T. Ikeda, P. Mayzaud.

Following a suggestion by telex from Professor El-Sayed, Dr. R. George was invited to attend as an observer on behalf of Dr. R. Ross.

Apologies for absence had been received from Dr. Murano and Dr. Ross.

1. Opening of Meeting

The Chairman welcomed participants to the meeting and noted that they had taken the opportunity for discussion offered by the Krill Biology Workshop which had just finished. The success of the workshop had meant that many of the topics of interest of the Working Party had been discussed in a much wider forum. The W.P. meeting therefore covered topics outside the scope of the Workshop and matters arising from the Workshop discussion.

2. Post-FIBEX Data Workshops

During the Nikko meeting of the Group of Specialists it had been agreed that further data workshops should take place. The Chairman reported on correspondence he had had on the subject; the main points were as follows:

1. A tentative date had been agreed for a Workshop during the period July-September 1984.
2. All queries should be formulated well in advance of the Workshop.

3. Professor Hempel had asked Dr. Astheimer of AWI to act as a liaison between the biologists of BIOMASS, and Professor Schmidt and his computing group at Fachbereich Informatik in Hamburg.

In addition considerable progress had been made with interpretation of the oceanographic data and it was agreed that this would considerably improve the quality of studies of biological topics.

The W.P. considered topics which might be investigated at a data workshop. These are listed below:

1. Distribution of larvae with respect to (w.r.t.) bathymetry
2. Distribution of larvae w.r.t. time
3. Distribution of larvae w.r.t. locality
4. Distribution of larvae w.r.t. water masses
5. Distribution of gravid females w.r.t. water masses
6. Distribution of gravid females w.r.t. locality
7. Distribution of gravid females w.r.t. time
8. "Larval Flow Model". Using data associated with the large concentration of larvae found in the Scotia Sea:
 - (i) Back calculate to estimate the location and size of the spawning zone
 - (ii) Forward calculate to predict the localities where the resultant adolescent and adult krill might be found.
9. Compare size frequency distributions of krill from different areas designated by water masses.
10. Estimate abundance of krill, stratifying by major water types.
11. Estimate abundance of krill of major size classes.
12. Apply Principle Component Analysis to all variables associated with krill swarms so as to determine the dominant factors associated with swarming.

Presented in this form the queries are inadequate for preparing process programmes and will require more precise specification.

It was also noted that considerable progress had been made with analysing FIBEX samples and it was agreed that scientists should be invited to submit the additional data to the Database. The Chairman was requested to do this by, in the first instance, writing to Chief Scientists. The Chairman would also contact the Chairman of other W.Ps. with a view to investigating interacting problems.

3. Krill Age Determination

The W.P. were pleased to note the progress being made in age determination methodology by Ettershank. If proved successful and reliable this technique will be available for Krill Population Dynamics studies. In order to test the methodology fully the W.P. felt that a standard protocol would be helpful. This could be distributed as a BIOMASS Methods Handbook.

4. Krill Physiology

Discussions of the sub-group on Physiology and Biochemistry during the Krill Biology Workshop had highlighted two major areas for development:

age-pigments (discussed above), and a coherent approach to krill energetics. There are many data sets available for several areas of krill physiology, but these are not always easily comparable and in some key areas (for example, assimilation efficiency) there are no data at all. The sub-group had suggested that what was needed was a multi-investigator program based at a good shore laboratory, to tackle the outstanding problems in an intensive and coherent manner. This suggestion had been noted in the plenary discussions during the Krill Biology Workshop, and it was agreed to be an important proposal.

The krill ecology W.G. also welcomed this potential development, and P. Mayzaud and A. Clarke agreed to produce a draft outline for the form such a program might take. P. Mayzaud would contact all interested parties (and potentially interested parties) and ask for suggested projects by mid July. A. Clarke would then draft an overall proposal for submission to the BIOMASS executive; this proposal would be ready in time for the SCAR Biology Symposium in Wilderness, 12-16 September, 1983.

5. Date of Next Meeting

It was agreed that a further meeting would be necessary and it was felt that this could usefully be timetabled to take place around the time of the Post-FIBEX Data Workshop on Krill Ecology planned for summer 1984.

6. Closure of Meeting

The Chairman then thanked the members of the W.P. for their efforts both during the Workshop and also during the Working Party Meeting. He also thanked Professor Hempel and his staff at the Alfred Wegener Institute for all their help during the meetings. The meeting was then closed.

LIST OF PARTICIPANTS

ANTEZANA, Tarsicio	Marine Biological Station University of Concepcion Dichato, Chile
ASTHEIMER, Henning	Alfred-Wegener-Institut für Polarforschung Columbus Center 2850 Bremerhaven Germany (Fed.Rep.)
BEDDINGTON, John R.	International Institute for Environment and Development 10 Percy Street London W1P ODR, Great Britain
BUCHHOLZ, Fritz	Institut für Meereskunde Düsternbrooker Weg 20 2300 Kiel, Germany (Fed.Rep.)
CLARKE, Andrew	British Antarctic Survey High Cross, Madingley Road Cambridge CB3 0ET, Great Britain
DENYS, Charlène J.	1645 W. Waveland Ave. Chicago, Ill. 60613 USA
EVERSON, Inigo	British Antarctic Survey High Cross, Madingley Road Cambridge CB3 0ET, Great Britain
GEORGE, Robert Y.	Institute for Marine Bio-Medical Research University of North Carolina Wilmington, N.C. 2840, USA
GRANT, W. Stewart	Sea Fisheries Research Institute Private Bag X2, Rogge Bay 8012 Cape Town, South Africa
GUZMAN F., Oscar	Instituto Antártico Chileno Luis Thayer Ojeda 814 Casilla 16521 Santiago, Chile
HEMPEL, Gotthilf	Alfred-Wegener-Institut für Polarforschung Columbus-Center 2850 Bremerhaven Germany (Fed.Rep.)

HEMPEL, Irmtraut	Institut für Polarökologie Christian-Albrechts-Universität Olshausenstr. 40-60 2300 Kiel, Germany (Fed.Rep.)
HIRCHE, Hans-Jürgen	Alfred-Wegener-Institut für Polarforschung Columbus Center 2850 Bremerhaven Germany (Fed.Rep.)
HUNTLEY, Mark	Scripps Institution of Oceanography University of California, San Diego La Jolla, Ca. 92037, USA
IKEDA, Tom	Antarctic Division Dept. of Science and Technology Channel Highway, Kingston Tasmania 7150, Australia
KILS, Uwe	Institut für Meereskunde Düsternbrooker Weg 20 2300 Kiel, Germany (Fed.Rep.)
LUBIMOVA, T. G.	All-Union Research Institute of Marine Fisheries and Oceanography 17, V. Krasnoselskaya Moscow, B-140, 107140, USSR
MACDONALD, C. Murray	Ministry for Conservation Fisheries and Wildlife Division 250 Victoria Parade East Melbourne, Vic. 3002 Australia
MARSCHALL, Hans-Peter	Alfred-Wegener-Institut für Polarforschung Columbus Center 2850 Bremerhaven Germany (Fed.Rep.)
MAYZAUD, Patrick	Biochemie Marine Station Zoologique Boite Postale 28 06230 Villefranche sur Mer France
MORRIS, David	British Antarctic Survey High Cross, Madingley Road Cambridge CB3 0ET, Great Britain
MUJICA, Armando	Instituto Antártico Chileno Luis Thayer Ojeda 814 Casilla 16521 Santiago 9, Chile

NAST, Friedrich	Bundesforschungsanstalt für Fischerei Institut für Seefischerei Palmaille 9 2000 Hamburg 50, Germany (Fed.Rep.)
NEMOTO, Takahisa	Ocean Research Institute University of Tokyo 1-15, Minamidai, Nakano Tokyo 164, Japan
PANKRATOVA, Olga	Ministry of Fisheries of the USSR 12, Rozhdestvensky Bld. Moscow, K-45, USSR
POMMERANZ, Tilman	Institut für Meereskunde Düsternbrooker Weg 20 2300 Kiel, Germany (Fed.Rep.)
RAKUSA-SUSZCZEWSKI, Stanislaw	Instytut Ekologii PAN Dziekanow Lesny 05-150 Lomianki Waszawa, Poland
SAHRHAGE, Dietrich	Bundesforschungsanstalt für Fischerei Institut für Seefischerei Palmaille 9 2000 Hamburg 50, Germany (Fed.Rep.)
SCHNACK, Sigrid B.	Alfred-Wegener-Institut für Polarforschung Columbus Center 2850 Bremerhaven Germany (Fed.Rep.)
SCHNEPPENHEIM, Reinhard	Institut für Polarökologie Christian-Albrechts-Universität Olshausenstr. 40-60 2300 Kiel, Germany (Fed.Rep.)
SIEGEL, Volker	Bundesforschungsanstalt für Fischerei Institut für Seefischerei Palmaille 9 2000 Hamburg 50, Germany (Fed.Rep.)
STRÖMBERG, Jarl-Ove	Kristinebergs marinbiologiska station Kristineberg 2130 450 34 Fiskebäckskil, Sweden
TOMO, Aldo P.	Direccion Nacional del Antártico Instituto Antártico Argentino Cerrito 1248 1010 Buenos Aires, Argentina