

Honeywell ELAC

An Introduction to **ECHOSOUNDING**

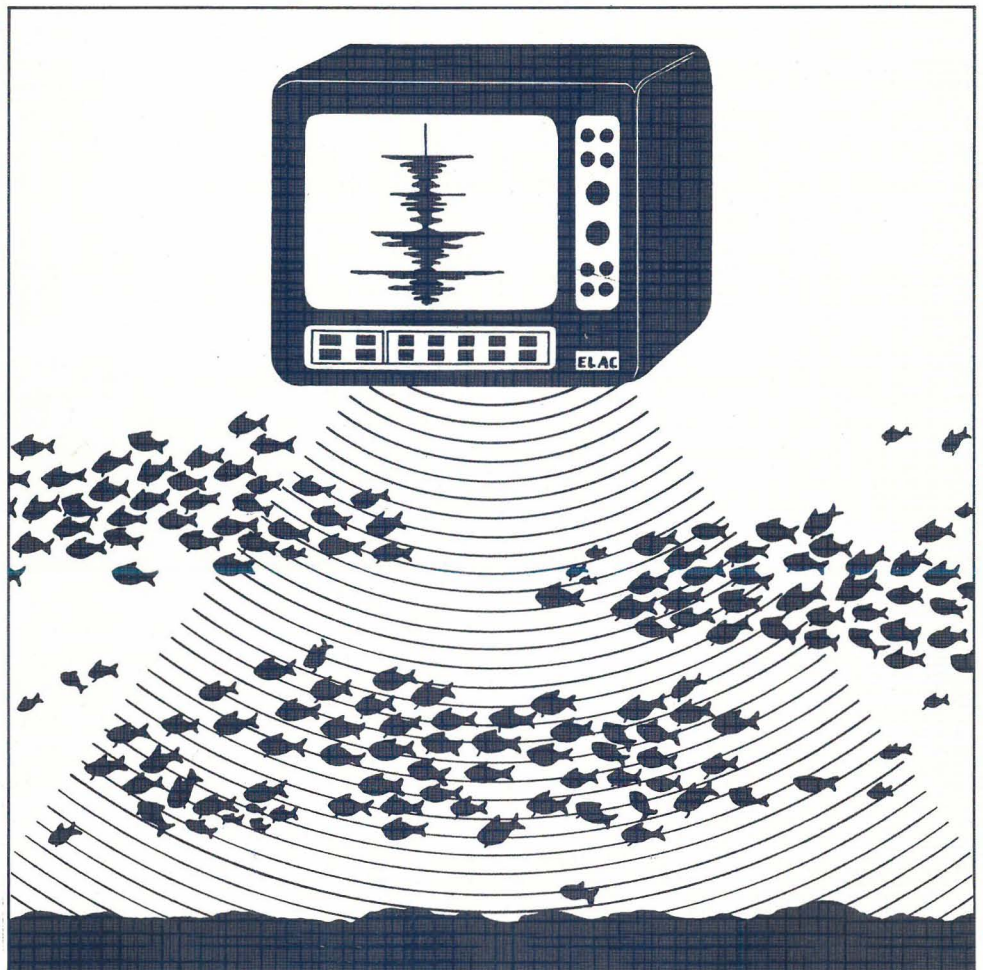



An Introduction to
ECHO
SOUNDING

Honeywell ELAC

CONTENTS

Sound	1
What is sound?	1
Propagation of sound	1
Sound waves	1
Number of oscillations	2
Tone, pitch, ultrasound	2
Strength of tone	2
Propagation of sound	2
Velocity of sound	3
Wave length	3
Reflection	3
Echo	4
Range and dispersion of sound	4
Absorption	4
General echo	4
Useful sound	5
Law of reflection	5
Shape of the reflector	6
Sea bottom	6
Influence of bottom surface	6
Strength of bottom echo	7
Fish in dense shoals	7
Echo strength, seabed, fish	7
Thin shoals of fish	8
Isolated fish	8
Why use ultrasound?	9
Wavelength and reflection	9
Length of pulse	9
Noise interference	9
Concentration and range	9
Concentration of ultrasound	10
Ultrasound absorption	10
Range	11
Transmission power	11
Sonic sounders	11
Sounding technique and sounders	11
Measuring distance by sound	11
Procedure employed	11
Distance of thunderstorms	11
Measuring distance by sound and echo	12
Principle of echosounding	12

Factors limiting accuracy of measurement	13
Velocity of sound	13
Sounding depth	13
Level seabed	14
Sloping seabed	14
Bumpy seabed	14
Echo from fish	15
How to avoid errors in measurement	15
Disadvantages of sharp concentration	15
Moderate concentration	16
Effective zone	16
Sounding technique	16
Ultrasound generation	16
Magnetostriction effect	16
Electrostriction effect	16
Resonant frequency	17
Release of energy	17
Transducers	17
Acoustic power	17
Sounding pulse	17
Inverse transducer effect	18
Resonance, selection of tone	18
Transducers and how to mount them	18
Amplification of reception	19
Time measurement and indication	19
Flash indication	20
Zero sound	21
Zero point setting	21
Indicating technique	21
Timing technique	21
Sounding ranges	22
Ambiguous depth indication	22
Reading accuracy	22
Repetition rate	23
Types offered	23
Characteristics of flash indication	23
Possibilities of application, navigation	24
Scope indication	24
Sounding ranges	25
Sizes of display	25
Repetition rate	25
Timing technique	25
Indication	26
Reading sounded depth	26
Possible application	26
Graph indication	27
Mode of operation	27
Recording technique	27
Timing technique	28

Sounding ranges	28
Display selector	28
Echograph LAZ 72	28
Echograph LAZ 51	29
Survey Sounder	29
Repetition rate of sounding	29
Paper movement	29
Indicating technique	30
Paper advance and indication	31
Reading depth	31
Zero point setting	31
Checking accuracy of measurement	32
Characteristics of graph indication	32
Possible applications	32
Interpretation of indications	33
Effective Zone	33
Shape, cross section	33
Shape, longitudinal section	34
Size	34
Transmission power	34
Properties of reflection	35
Amplification of reception	35
Maximum size	36
Depth constraint	36
Length of echoes	36
Indication of echolength	37
Echolength and diameter of effective zone	37
Indications of seabed	38
Multiple echoes	38
Multiple echoes in flash indication sounders	39
Multiple echoes in sounders with fischlupe	39
Multiple echoes on recorders	39
Degree of amplification	39
Sounding depth	39
Nature of seabed	40
Wrecks and projecting rocks	40
Bottom layers	40
Vertical movements of ship	41
Rolling and pitching	41
Water containing air	42
Rough or wavy seabed	42
Errors in depth measurement	43
Sloping seabed	43
Indication of slopes	44
Flash indication	44
Scope indication	44
Graph indication	45
Mistaking bottom echoes for fish echoes	45
Errors in depth measurement	45

Indication of fish	46
Amplification of reception	46
Degree of amplification	46
Ship noise and range	46
Setting for proper degree of amplification, sounder with flash indication	46
Fischlupe	47
Echograph	47
Interference from other sounders	47
Sounding for single fish (straggler fish)	48
Indications of single fish (straggler fish)	49
Practical example	50
Ship and fish in motion	50
Tuna	50
Indications of shoals of fish	51
Resolving power	51
Indications of shoals on Fischlupe and echograph	51
Depth of shoal	52
Thickness of shoal	52
Length of shoal	52
Correction	52
Estimating the quantity of fish	53
Shoals of fish close to the seabed	53
Importance of echolength	53
Example	54
Fischlupe indication	54
Graph indication	54
Flash and scope indications in rough sea	54
Graph indication	55
Catching white fish	55
Combined sounders	55
Amplification dependent on depth	55
Recognition of species of fish	56
The Netsounder (Netzsonde)	57
General	57
Operating principle	57
Interpretation of indication	57
Catch indicator	58
Temperature indicator	58
Equipment versions	58
Fish detection with horizontal sounders	59
General	59
Operating principle	59
Special features of horizontal sounding equipment	59
Sound water	60
Set up of a horizontal sounder	60
Echo indication	61
The catching process in purse seine fishing	62
The catching process in trawling	62

P R E F A C E

For a long time, the echosounder has been an indispensable aid to navigators. Its ability to supply depth measurements in practically all weather conditions without impeding the crew's activities gives it a distinct advantage over the earlier lead-line sounding technique. This particular feature has made it invaluable for finding the ship's position, thus reducing the risk involved in maneuvering near coastal and shoal waters. With echosounders, trawlers can fish along shelving coasts and banks once considered too dangerous to operate near. Due to improvements and innovations in the equipment, echosounders now are able to find fish. The advantages this brings to the fishing trade are obvious. Nets need no longer be shot haphazard because the new method makes it possible to detect fish more rapidly and with less trouble than by test catches. In ground net trawling, these modern fish-finding sounders are further useful in that they enable the skipper to steer clear of wrecks or rocks which would tear his net. They also facilitate estimating during trawling how full a net may be. Economically speaking, mid-water trawling has been made possible for the first time through the invention of fish-finding sounders. Without them, nets could not be lowered with any degree of certainty to the level above the seabed where a shoal of fish is located. Reading echosounders which indicate only water depth is comparatively easy, and the values obtained are usually accurate. To operate instruments of this type, the user merely has to follow simple instructions. This is different with equipment employed to locate fish. These sounders are provided with special indicating systems adapted to the new tasks they are to fulfill. Operating the instrument and reading depth is not any more difficult with these new instruments, but obtaining clear indications of fish, and, more so, interpreting these indications correctly, is not as easy. A skipper must use an intelligent approach if he wants to derive full benefit from the apparatus. Common sense alone, however, is not enough. He will have to acquire a certain amount of expert knowledge and some experience. Experience will come by itself in the course of time, but this booklet will help you acquire the necessary technical know-how without enlarging on a lot of unnecessary details. Modern echosounders, particularly those serving to find fish, have attained a high degree of technical perfection. Research is constantly underway to achieve still better results. The effective use of these instruments, however, does not depend on the perfection of the apparatus alone. The user must decide whether he wants to obtain the best results, or if he will be satisfied with less than the very best. By fully, and intelligently exploiting all possibilities, he can achieve the best results. Many scientists and engineers have been and are still working on the problem of locating objects by sound. There are many points that have not been cleared up as yet, and new problems arise as the development of echosounders proceeds. This booklet will tell you of the results obtained in this field to date. Information of this kind is also found in shipping and fishing periodicals. Seamen and fishermen alike are invited to study these publications.

SOUND

The echosounders reviewed here and those designed for horizontal sounding such as ASDIC or SONAR, operate on sound waves. In this way, they differ from RADAR, which serves to locate objects above water by using electric waves. These devices should not be confused with each other, as is frequently done. It is not without good reason that sound is used in water and electromagnetic waves in air. The selection is based on the peculiar properties of the two types of oscillations. Though the object is identical, sound waves are better suited for transmission through water, and electric waves through air. So, for reasons that need not be explained here, one would not try to find fish with radar, nor spot planes with an echosounder or ASDIC. Since we are dealing with echosounders, we will confine our discussion to sound and neglect the phenomena of electric oscillations.

WHAT IS SOUND?



Sound is not a thing, nor is it matter. It is a process of oscillation or vibration. It is produced by a sound generator such as a steam whistle, the horn of a car, a musical instrument or an audio-oscillator and the like, which puts adjoining particles of the ambient medium (gases, fluids or solid bodies) into vibration. One might imagine that the particles which make up the medium are similar to each other and elastically connected.

PROPAGATION OF SOUND

When a particle is induced to oscillate, it pushes or pulls its neighbours and transmits the oscillating energy to them. In this way, the oscillation spreads from particle to particle, in every direction, without the particles changing their location very much. Thus, in sound propagation, it is energy that is transported, not mass, as in a jet of water.

SOUND WAVES



Since this passing of energy from particle to particle is a progressive process, adjacent particles are not in the same state of oscillation. The particle imparting energy is ahead, in this respect, of the one that receives energy. The result is that the propagation takes the form of waves. In gases and fluids, the particles oscillate elastically in the direction of propagation, producing compressions and decompressions (longitudinal waves) in the medium. The process can also be presented symbolically in the form shown opposite (as transverse waves), the upper portion signifying a compression and the lower portion a decompression, while the straight line represents the position of rest, around which the excited particles oscillate. The compression and decompression constitute a sound wave. This process can be demonstrated by throwing a stone into a lake. The stone takes the place of the source of sound, and circular trains of waves move away from the spot where the stone is dropped. But waves so produced are not sound waves. Also, particles of water oscillate too slowly.

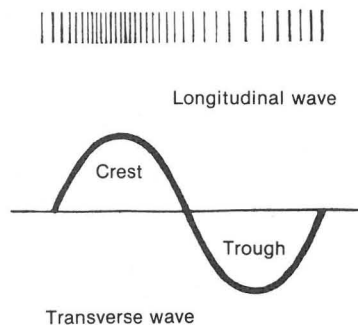

NUMBER OF OSCILLATIONS

What we understand as sound is only that process of oscillation which the human ear perceives as noise, tone, etc. Therefore, what is of importance as a criterion, is the number of oscillations, or the number of waves produced in one second. This is termed **FREQUENCY**. One cycle signifies one oscillation per second. One thousand oscillations or cycles are called one kilocycle (Kc.). The human ear senses oscillations between about 16 and 20000 cycles per second.

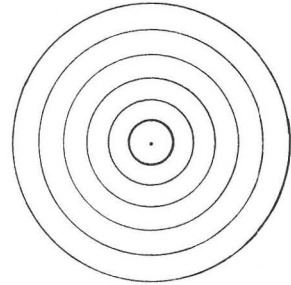

TONE, PITCH, ULTRASOUND

Sound, such as noise, music, etc. is composed of tones. A tone is an oscillation of a definite and constant frequency (pitch). Thus, the concert pitch a, important in music, has a frequency of exactly 435 c/s. A tone of lower frequency, down to about 16 c/s, is felt as a tone of lower pitch, and a tone of higher frequency, up to about 20000 c/s, as a tone of higher pitch. Oscillations that have a frequency of more than 20000 c/s, which the human ear does not hear, are termed **ULTRASOUND**. In echo-sounding, we are chiefly concerned with ultrasound.

STRENGTH OF TONE

Tones may also differ in strength. A strong tone is produced by a strong generator of sound, and is distinguished by strong oscillations. Its waves have higher crests and deeper troughs, and the width of their oscillation is greater than that of softer tones. This width of oscillation, which denotes the strength of the tone, is called **AMPLITUDE**.

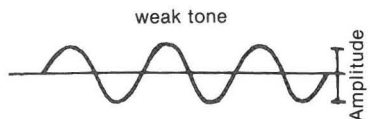
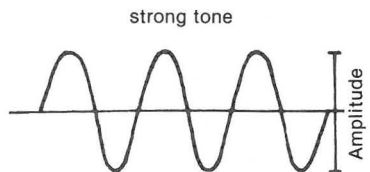
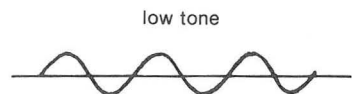
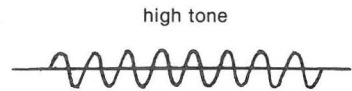

PROPAGATION OF SOUND



As stated above, sound is propagated - a fact which we know from experience. No conversation, for instance, would be possible without sound propagation. It was also pointed out that the propagation of sound is bound up with a medium such as gas, fluid or a solid body. Where there is no medium, as in a vacuum, there is no sound. A frequently used laboratory test apparatus illustrates and proves this fact. In an air-tight glass container, a bell is hung which can be set in motion by a switch. A sound can then be distinctly heard. By throwing another switch, an air pump is set in motion, evacuating the air from the container. The longer the pump works, the softer is the sound of the bell. Finally, when practically all air has

been removed, no ringing can be heard, although the gong is seen striking the dome with the same force as when the sound was heard. This interesting test leads us to another important point in sound propagation: VELOCITY.

VELOCITY OF SOUND

The test cited above shows that the manner of propagation of sound must depend on the medium (gas, fluid, solid). Since no sound is propagated in a vacuum, the velocity there is equal to zero. It may be presumed that the velocity is different in each medium, owing to its different nature. A great number of tests and measurements made of the velocity of sound in different materials have shown that this is true. In water (fluid) sound is propagated faster than in air (a mixture of gases). In steel (solid) it is propagated more quickly than in water. Echosounding takes place in water, but water varies as far as sound propagation is concerned. Accurate measurements have shown that sound is propagated more rapidly in salt water than in fresh water. In warm water, it propagates more rapidly than in cold water. As we shall see further down, in echosounding it is necessary to know the precise velocity of sound. Echosounders for navigation and fishing are preset at the factory for normally prevailing conditions. But since abnormal conditions of temperature and salinity are bound to occur, errors in measurement up to $\pm 4\%$ can result if the sounder is set for normal velocity. These errors do not, as a rule, affect navigation or fishing, but will affect hydrographic operations requiring greater accuracy. To correct these errors, the equipment must be reset according to recommendations on charts which give the correct velocity of sound for exceptional temperature and salinity conditions.

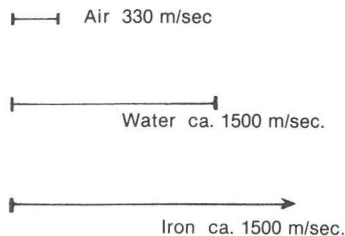

WAVE LENGTH



The frequency of a tone and velocity of its propagation determine the length of its wave. Sound in water, for instance, covers about 1500 m/sec. (about 4920 ft./sec.). In one second, a tone of 1000 c/s. performs 1000 oscillations while covering the distance of 1500 m (4920 ft). Therefore, 1000 waves added up have a length of 1500 m (4920 ft). One wave, being 1/1000 part of this, has a length of 1.5 m (4.92 ft). The general equation for this relationship is:

$$\text{Wavelength} = \frac{\text{Velocity of Propagation}}{\text{Frequency}}$$

An ultrasonic oscillation of 30 Kcs, as used with many types of echosounders, ELAC Fischlupe and Echograph among them, has a wavelength in water of 5 cm, while 50 Kcs, which is also very suitable for echosounding, has a wavelength in water of only 3 cm.

REFLECTION

When sound, traveling through a medium, reaches the border separating it from another medium (in which it would have a different wavelength and speed) - as in water at the surface and at the bottom of the sea, - two things happen. A portion of the sound will enter the other medium, and a portion will be reflected. The proportion of sound penetrating and that being reflected depends on the nature of the two media. At the border between water and air, for

instance, practically all sound is reflected because the media are very different from each other. The portion of sound that penetrates the other medium is virtually nil. The greater the difference between two adjacent media, the greater is the reflected portion of the sound. Except for size, objects such as fish (composed of bones, scales, bladder and meat) in a medium of water will have the same reflection characteristics as the border area between two different media. Broadly speaking, border areas between different media represent obstacles standing in the way of the propagation of sound. The amount of sound which is reflected from border areas is determined by the difference between the adjoining media. In simple terms, we might say that sound is rather unwilling to leave the medium in which it was generated. Because it is this characteristic of sound reflection that makes echosounding possible, we must learn more about the laws that govern it. The following paragraphs illustrate the principles involved.

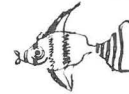

ECHO

The echo principle is very simple and anybody who has ever taken walks in mountainous areas knows about it. If you stand away from the mountain and shout out, then, after a few moments, the shout will return as an echo. It is always weaker and sometimes distorted. The rock as a medium is quite different in its material composition from the air in which the sound was propagated. Therefore, very little is lost through penetration into the rock when sound is reflected from it. Why then is the echo weaker than the original shout? Principally for two reasons. The first is based on the laws of sound propagation, while the second lies in the manner in which sound is reflected from obstacles.

RANGE AND DISPERSION OF SOUND

Normally, as we have learned, sound emanating from a central source will spread uniformly in all directions. One might compare it with a set of spherical shells placed one inside the other. As sound spreads, it is dispersed and 'diluted' increasingly as it moves away from the spot where it originated. Since the surface of the sphere grows in proportion to the square of the radius, it is four times larger when the radius is doubled, nine times as large with three times the radius, and so forth. Thus, only one quarter of the sound intensity will impinge on a certain surface (ear drum, microphone membrane, echosounding transducer) at twice the distance, and one ninth of the intensity at three times the distance from the source. This means that the sound intensity per unit of surface decreases in proportion to the square of the distance covered when the sound is propagated in all directions (undirected sound).

ABSORPTION

Apart from this, sound is also weakened by absorption while passing through a medium of propagation. To what degree it weakens by absorption depends on the nature of the medium and also on the frequency of sound. We shall see farther down how important this is to sounding technique. Since the phenomena of dispersion and absorption of sound are universally applicable, they weaken both the emitted sound and the reflected echo. In general, their influence determines the range of sound and, to a great extent, the range of the echo, whose strength is dependent substantially on the conditions of reflection.



GENERAL ECHO

The fact that sound is reflected has already been established, but it must also be understood why and how. We cannot be satisfied with the fact that an echo is produced by reflection. As we are studying this matter with relation to echosounding, we must distinguish between a 'general echo' and a 'useful echo'.

USEFUL ECHO

When a man shouts, his mouth is the sound source and his ears, located close to his mouth, are the sound receivers which pick up the echo thrown back. Similarly, in echosounders for navigating and fishing, the sound transmitter and sound receiver are closely positioned in order to pick up as much of the echo as possible. That portion of the echo which returns to the sound receiver is known as the useful echo. The strength of the useful echo, however, does not depend solely upon the proximity between the transmitting and receiving source. Aside from the effects of dispersion and absorption, the shape, position and nature of the surface of the reflecting object (wall of rock, seabed, etc.) determine the strength of the useful echo.

LAW OF REFLECTION

Reflected sound behaves much the same as light. Just as a beam can be made by letting sunlight into a dark room through a narrow hole, we can, theoretically, pick out a beam of sound from the total amount produced by some source, and put it down on paper in the shape of a straight line. When that beam strikes a reflecting surface at right angles, the echo will return along exactly the same path to its point of origin. But if it strikes the reflecting surface at another angle, its reflection will deviate in a definite way. If we draw a perpendicular to the reflecting surface (axis of incidence), the angle between the beam of sound and that perpendicular axis (angle of incidence) is equal to the angle between the echo beam and the perpendicular (angle of reflection), with the sound beam, the perpendicular and the echo lying in one and the same plane. From this we derive the following law which is valid throughout the theory of oscillation: In reflected oscillation (of sound, light, etc.), the angle of reflection is equal to the angle of incidence. We now understand that the first case described of a sound beam hitting the reflecting surface at right angles and being thrown back into itself is only one of the many cases possible. But for our consideration it is the most important case. From the law of reflection we can infer that it is only in this particular case that echoes will return to the place where the sound emanated (i.e. to the ear of the man who waited for the echo to return from the rock face, or to the receiver mounted close to the transmitter of an echosounder). The beam of sound, the axis of incidence, and the beam of the echo coincide because they are all at right angles, at the same point, to the surface of reflection.

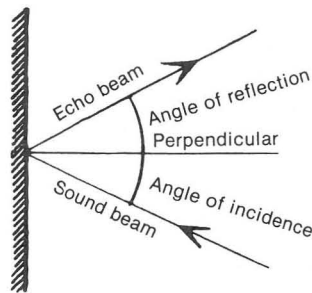
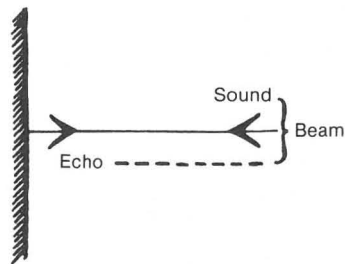

POSITION OF THE REFLECTOR

Knowing this, we understand why we cannot see ourselves in a mirror, except when standing directly in front of it. Or, why, when looking into the mirror from the side, we see things that

appear at the same angle on the other side of the mirror. Another example of a similar condition is that of a billiard ball hitting the cushion either at right angles or at a slightly acute angle. The ball will either return to the point from where it was pushed or it will roll away, more or less deflected, in a new direction.

SHAPE OF THE REFLECTOR

This explains why, in natural surroundings, there are so few really perfect echoes, or producers of echoes. A perfectly smooth wall of rock will reflect as a useful echo only the small portion that strikes it at right angles. The major portion of sound strikes it obliquely and is deflected sideways as shown by the law of reflection. Therefore, a smooth rock wall or a brick wall is not a good producer of useful echoes. Their shape prevents it. A concave mirror, however, is a good producer of echoes if it is properly shaped and correctly positioned in relation to the observer. The concave mirror as an echo transmitter is not of interest to echosounding, and we will not attempt to discuss the problem of shaping such a reflector. The reflecting surface most frequently met with in echo sounding technique has the rather unsuitable shape of a surface lying at right angles to the sound incidence. This very important echo producer is the bottom of the sea.

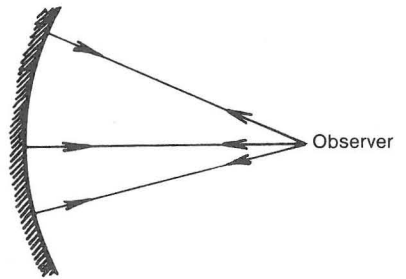
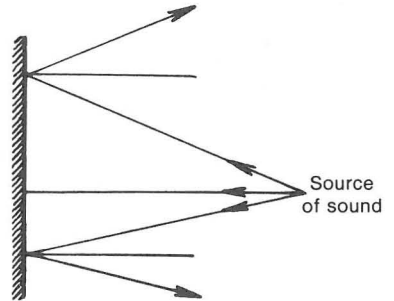

SEA BOTTOM



From what has been said about conditions governing reflected sound, it might be assumed that a horizontal and level seabed will produce more useful echoes (in the area directly below the ship) than an inclined bottom (shelves near coasts or banks). Further, the law of reflection states that no useful echoes of vertically emitted sound could return to the ship from an inclined seabed. Experience has shown, however, that this assumption is wrong. This can be explained by the fact that even the most level seabed has few of the properties of an ideal mirror. It reacts to sound much like a distempered wall does to light.

INFLUENCE OF BOTTOM SURFACE

Just as a distempered wall is coarse to light, the bottom of the sea, composed as it is of rough substances (stones, gravel, sand, mud, etc.) and never absolutely level, is coarse to sound. When

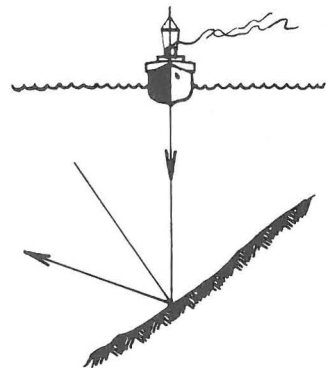

hitting this rough reflector, sound will not follow the basic law of reflection and be deflected as a whole, but will be diffused in the same manner light is diffused, when reflected from a distempered wall. When sound hits a rough surface, it meets with a great number of 'small surfaces' pointing in all possible directions relative to the direction of incidence. If one were to look at such a rough surface with a magnifying glass, he would see that part of the surface is perpendicular to the axis of sound incidence. This surface will give a useful echo. On the other hand, the majority of small surfaces do not lie at the same angle as the axis of incidence, and the portion of sound hitting these surfaces will be deflected in all directions and be useless for sounding. It is obvious furthermore that, in respect to this roughness of the seabed, nature has provided a great variety of transitions from clay, sand, gravel and pebbles up to broken rock of all sizes. As a result, there will be a great many changes in the strength of the useful echoes, whether on level or shelving ground.

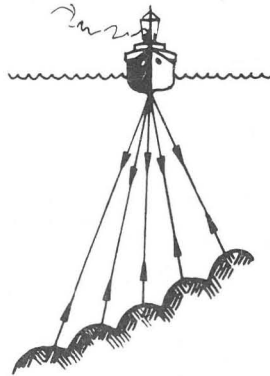

STRENGTH OF BOTTOM ECHO

In spite of this roughness, the bottom of the sea, whether vertical or at an angle to the axis of incidence, produces more useful echoes than it would if it had the polished surface of a mirror. From what we have said about the fundamental laws governing reflection, we know that, as a rule, the bottom of the sea will give fewer strong and useful echoes as it inclines from the horizontal.

FISH IN DENSE SHOALS

Let us now consider a large shoal of herring, so densely packed that one fish practically touches the other, and that the upper surface is more or less level. With its position to sound incidence and regarding the rough nature of its surface, this shoal would be like a seabed consisting of large pebbles. If we consider the previously mentioned characteristics of shape, position and nature of surface, the shoal should produce an echo very much like that of a similar seabed i.e. an equal amount of useful soundings, resp. echoes. Actually, however, the echo from a shoal of herring is weaker. This is explained by what has been said about the material composition of echo producers and the influence it has on the strength of echoes.



ECHO STRENGTH, SEABED, FISH



The seabed is composed of rather hard bodies. In our example these bodies are stones. Fish, as we know, consist of much softer elements, such as scales, bones and meat. The

difference in substance between stone and water is greater than between fish and water since 80% of the fish is water. It is obvious therefore that, even from extremely dense shoals of fish, as in our example, we cannot expect an echo as strong as is produced by a similarly formed seabed. More generally it may be said that most of the other marine organisms will give weaker echoes (because of their material composition) than do most of the dead objects found in the sea.

THIN SHOALS OF FISH

Looking at the case of a shoal of fish loosely packed and consisting of one layer only as shown in the sketch, it is evident that we are now considering a new condition. This thin

shoal of herring is a producer of echoes of a different type and is distinguished from the others we have been considering, in that a portion of the sound will pass right through it. It might be compared to a sieve. The greater the clearance between the individual members of the shoal, the wider would be the meshes of the sieve and the greater is the portion of the sound that would pass through it. It is clear from this that the less dense a shoal of fish is, the less sound it will reflect. It is possible, of course, that sound passing through the openings in the shoal will encounter other objects from which it will be reflected. These objects vary. They may be fish of the same shoal swimming at greater depth, or possibly, the bottom of the sea. Those familiar with echosounders know that the seabed below a shoal of fish is almost always shown on the instrument unless the water depth exceeds the range of the sounder. They know, too, that the thickness of the shoal will also be indicated. (We shall see below that there are reservations regarding the reliability of indications of thickness). Normally, there are virtually no shoals so heavily packed that they would prevent any sound from passing through. This fact is particularly useful in fish finding. If the bottom echo could not be received, bottom trawling would be handicapped considerably.

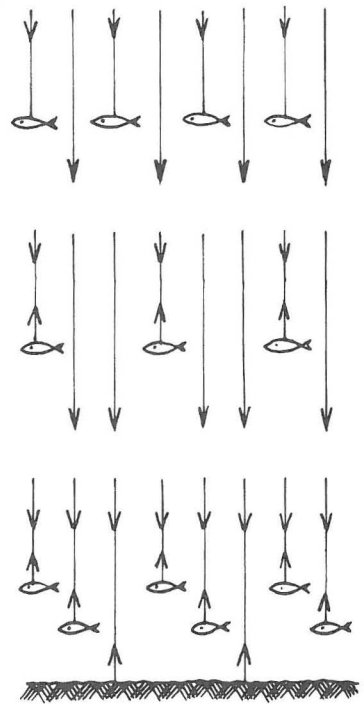

ISOLATED FISH

As the distance between fish in a shoal is increased, eventually the resulting echo will be that of a single fish. It is evident that this single fish would give the weakest echo of the lot. Like any other producer of echoes, it cannot reflect any more sounds than impinges on it. Naturally, the amount of sound hitting one fish is smaller than that hitting a number of fish i.e. a shoal. Consequently, a single

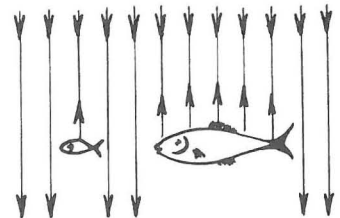

fish will produce weaker echoes than a group of fish. By the same token, less sound will hit a small fish than a big one. That is why echoes from small fish are different from those coming from big fish. In summation, we might say that the denser a shoal is, the stronger is its echo. A shoal of fish gives a stronger echo than does an individual member of the shoal, and a big fish gives a stronger echo than a small fish.

WHY USE ULTRASOUND?



WAVELENGTH AND REFLECTION

We have seen that in modern echosounders ultrasound (over 20000 c/s.) instead of audible sound (16 c/s. to 20000 c/s.) is used almost universally, especially in sounders designed for fish finding. One of the reasons for this is that the ratio between the size of the echoproducer and the wavelength of the sound in question has an influence on the quality of reflection. When a storm beats on a pierhead, the waves are thrown back, but they pass by a single pole near the pierhead without any remarkable reflection. While the pierhead is big in comparison with the wavelength, the pole is small. The water waves mentioned here as well as any sound waves are so much the more reflected as the echoproducer is several times bigger than the wavelength. From what has already been said, we know that because of its higher frequency ultrasound has shorter waves than audible sound. In water, a tone of 1000 cycles has a wavelength of 1.5 m (4.92 ft), and a tone of 30000 cycles, which is used in many echosounders, has a wavelength of 5 cm (2'). Therefore, ultrasound will be reflected better by smaller objects, such as fish, than will audible sound. A rule of thumb says that the best conditions of reflection exist when the wavelength of sound used for sounding is not much longer than the diameter of the fish being sounded. Therefore, an ultrasonic pulse of 30 Kcs with a wavelength of 5 cm (2') is particularly well adapted for bigger fish, and sound of 50 Kcs and wavelength of 3 cm is better for smaller fish, such as anchovies or sardines.

LENGTH OF PULSE

In ultrasound, very short sound pulses are emitted which, as is to be shown, are indispensable in 'resolving' echograms, particularly of fish.

NOISE INTERFERENCE

Any ship in motion will produce noise, which is apt to be picked up by the receiving transducer of the sounding equipment thus interfering with the indication of the actual echo. Most of these noises caused by the rush of water, the pounding of engines or the propeller are within the range of audible sound. When using a receiving transducer tuned to ultrasonic frequencies, these noises will not or barely be received, and indication of echosignals will be less affected. Apart from this, sound pulses audible to the human ear, such as those from sonic sounders or impact sounders, may in the long run become a nuisance to the crew.

CONCENTRATION AND RANGE

Ultrasound has several other advantages over audible sound. We have seen that sound ordinarily spreads in all directions, and that as a result, the intensity of sound per unit of area decreases in proportion to the square of the distance. It is possible, however, by adequate construction of the source of sound, to prevent the sound from spreading evenly in

all directions, i.e. focus most of it into one definite direction. One example of this is the megaphone. Every sailor knows that by means of this instrument the sound is concentrated and considerably magnified within the range of the human voice. In many instances, however, the concentration achieved with the megaphone does not suffice, and other methods must be employed. In sound signalling equipment, for example, a number of sound sources are arranged on top of each other at a certain distance. In this way it is possible, for reasons not to be explained here, to obtain sufficient concentration and range for signalling stations such as ELAC foghorns. One could proceed in the same way in underwater sounding if the apparatus required to transmit the sound was not so bulky and undesirable for various other reasons. With ultrasound, better results are obtained, and we shall now explain why.



CONCENTRATION OF ULTRASOUND

In the transmission of sound, the degree of concentration achieved depends upon the ratio of the wavelength to the diameter of the radiating surface. The latter must be greater than the wavelength. If one were to concentrate audible sound of 1000 c/s in water, with wavelength of 1.5 m (4.92 ft), the radiating surface would have to have a diameter of at least 1.5 m (4.92 ft). This would certainly involve technical difficulties. Using a 30 Kcs sound pulse and a wavelength of 5 cm (2"), a sound transducer with adequate radiating surface can easily be constructed. A TRANSDUCER with a frequency of 30 Kos as would be used today has a radiating surface of about 8.5 x 14.0 cm. The smaller diameter, therefore, equals approx. 1.7 wavelengths and the long diameter 2.8 wavelengths. In order to obtain the same concentration with higher frequencies, the transducers may be correspondingly smaller. It is obvious from this that ultrasound favors concentration of radiated sound to an exceptional degree. This concentration is of very great importance for the efficiency of the sounding technique. It enables the indication of depth to be more accurate when the seabed is of a peculiar contour, and it improves the interpretation of the signals from fish which, in fact, would be impossible without concentration.

ULTRASOUND ABSORPTION

For the already mentioned reasons, ultrasound is preferred in echosounding and, for the same reasons, is a must for fish finding sounders although compared to sound of low (audible) frequency it has one important disadvantage. At equal transmission power the range of sounding is shorter. We have seen that the range of sound, apart from being dispersed in space, is limited by gradual absorption of the sound on its way through the medium of propagation. The rate of absorption, however, is not equal at all frequencies, but increases greatly with higher frequencies. What we are saying is that an ultrasound pulse is more thoroughly absorbed and does not, therefore, reach as far as audible sound. In this respect sounding technique is in a dilemma. To make best use of the advantages presented by ultrasound, it is desirable to use frequencies that are as high as possible. Nevertheless, sounders are expected to have a certain minimum range which may almost impossible to achieve with high frequencies. Today's sounding frequencies range from 20 to 50 Kcs, depending on the operations to be performed. (In special cases, frequencies of up to approx. 200 Kcs are employed).

RANGE

Ultrasonic sounders which are commonly used in navigation and fishing will sound water depths to a maximum of 3000 m (approx. 1660 fathoms). (Usually, the instrument scales do not attain such a value). Fish have been detected with these sounders down to depths of over 1000 m (approx. 555 fathoms).

TRANSMISSION POWER

This range which is extraordinary for ultrasonic sounders, is obtained by means of a high transmission power, good receiving amplification, and as mentioned above, the concentration of sound. In ELAC sounders, the electric transmission power is approximately 5 watts per cm² (32 watts per square inch) of the radiating surface, which corresponds to a pressure of approximately 4 b. Higher ratings of power are of no use to sounding because they will give rise to the formation of vacuum bubbles in the water near the transducer surfaces (cavitation). We have seen that no sound is propagated in a vacuum. These little bubbles would impede the radiation of sound. Amplification and concentration of sound which, as we have seen, also affect the range, will be discussed in detail later on.

SONIC SOUNDERS

The range of modern ultrasonic sounders meets the requirements of navigation and fishing. When greater depths are to be measured, sound of audio frequency must be used instead of ultrasound, for reasons explained. With so-called sonic sounders, such as the ELAC Deep Sea Sounder, any depth of water up to 11000 m (approx. 6110 fathoms) can be sounded. In such a case, the disadvantages of sonic sound for echosounding have to be taken into account, especially where high accuracy of measurement is required.

SOUNDING TECHNIQUE AND SOUNDERS

PRINCIPLES

MEASURING DISTANCE BY SOUND

We have seen that sound is propagated at a certain velocity which, independent of frequency, wavelength and intensity of sound, is determined exclusively by the nature of the medium of propagation. The velocity of propagation has been measured for a great number of media (gaseous, fluid, and solid bodies). Proceeding from these facts, the velocity of sound can be used to measure distances.

PROCEDURE EMPLOYED

If we know that some short sound pulse is generated at a particular place and moment, all we have to do is to measure the time that elapses from that moment until the sound arrives at the spot where we stand. If we multiply that time (seconds) by the known velocity of sound (per second) in the medium concerned, the result is the distance from the spot where the sound pulse was generated, to our place of observation.

DISTANCE OF THUNDERSTORMS

In this way one can find out how far a thunderstorm is from a given point. We know that thunder is the product of lightning which, among other things, generates a light effect. Light is

propagated at a velocity of about 300000 km/sec. Thunder (sound in air) does not cover more than about 330 m/sec. Light, therefore, travels about a million times faster in air than sound. Its velocity is so great that the lightning, even if it flashes many miles away, is seen by us at practically the same moment. The thunder produced at the same time travels much slower and reaches the observer much later. Therefore, if we count the seconds between the flash of lightning and the thunder, multiplying the result by the velocity of sound per second, we have the distance of the lightning and of the thunderstorm from a given point. If, for instance, 3 seconds elapse between lightning and thunder, the distance is about $3 \times 330 = 990$ m (3×1000 feet or 3000 feet).

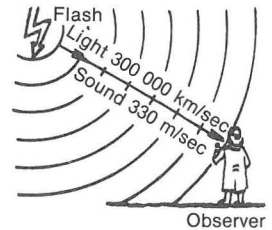

MEASURING DISTANCE BY SOUND AND ECHO

By the same method, one can determine how far he is from a wall of rock. He need only measure the time elapsing between a shout and the arrival of its echo. The sound emitted covers the distances not once but twice - there and back. The actual distance, therefore, is the result of multiplication of transit time and velocity of sound, divided by two. Counting three seconds between the shout and its echo, the sound again covers 990 m (3000 ft) in air, but the distance between the wall of rock and the place of observation is only one half the distance or 495 m (1500 ft).

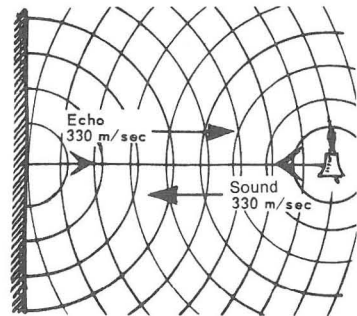

PRINCIPLE OF ECHOSOUNDING

This last example explains the principle of echosounding. It consists of no more than measuring the time between the generation of a sound pulse and the arrival of the echo, then multiplying it by the known velocity of sound and dividing the result by two. The schematic diagram of an instrument used for this purpose is shown here. A sound pulse is emitted into the water by a pulse generator via a transducer. The echo is picked up by a receiving transducer, is amplified and indicated by a combined timing and indicating unit. Details of the operation and construction of the transducers will be given in this text. At the time of invention of the echosounder, conditions were, of course, far from being as clear and natural as they are today. Therefore, the accomplishment of the German physicist Alexander Behm, who had both recognized the usefulness of this method for soundings in water and invented the first devices suitable for these operations, is to be highly appreciated. Dr. H. Hecht, physicist and

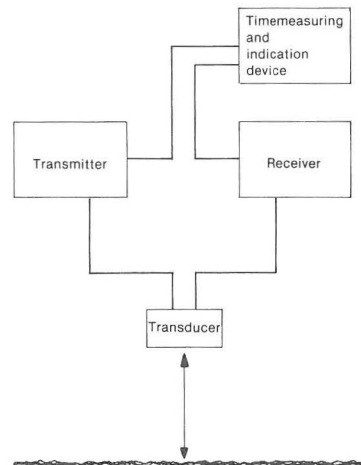

one of the founders of ELAC, promoted the technical development in this field by his investigations on sound propagation in water and shaping of hydroacoustic emitters. Physicists and engineers of many nations have since been seeking to constantly improve the echosounders. However, for this brochure, we will confine ourselves to a close examination of today's echosounders, with special regard to the products of Messrs. Honeywell-ELAC, Kiel.

FACTORS LIMITING ACCURACY OF MEASUREMENT

VELOCITY OF SOUND

It is evident that the accuracy in measuring distance by the echosounding method depends on two factors: the degree of accuracy of the known velocity of sound, and the accuracy of the time measurement. Many measurements of sound velocity are available. The exact influence of temperature and salinity of water is known and can be taken into consideration whenever required. It is also known that, as a result of these influences in natural surroundings, measurement errors up to $\pm 4\%$ can occur, i.e. in the North Sea, for instance, sounders set to normal conditions by manufacturer will indicate 100 m water depth as 100 m. In cold fresh water of the same depth, the sounder would, in an extreme case, indicate 96 m while in the Red Sea, which is very salty and warm, about 104 m would be indicated. If these errors are too great for the work to be performed, the sounder can be adjusted to prevailing conditions and will then measure more accurately.

MEASUREMENT OF TIME

The importance of accurate time measurement is shown by the figures listed on the chart below. The velocity of sound in water is about 1500 m/sec or 819 fms/sec. If the echo returns from the bottom 1 second after transmission of the pulse, the depth would be half that value, viz. 750 m or 409.50 fathoms.

410	fms depth = 1	Second of transit time
41	fms depth = 1/10	Second of transit time
4.1	fms depth = 1/100	Second of transit time
0.41	fm depth = 1/1000	Second of transit time
0.04	fm depth = 1/10000	Second of transit time

From this chart it is easy to see that, if the depth of water has to be measured within accuracy of 1 m or 3 ft, it is necessary that the transit time be measured accurately up to 1/1000 sec. If the depth has to be measured accurately up to 4' or 10 cm, as is demanded for survey work in rivers and harbors, the time must be measured accurately to within 1/10000 sec. This shows that a rather efficient timing instrument is required to measure very short intervals of time. Today's modern technology, of course, permits to precisely measure the depth of any sea bottom or the depth of fish and shoals of fish to within fractions of a meter or fathom.

SOUNDING DEPTH

As a rule, only distances between the transducer and the object that is being sounded (seabed or fish) can be measured by the echosounding method. These distances are sounding depths, but what the navigator or the fisherman wants to know is the true depth, i.e. the shortest distance between the object and the water surface. This requirement is most easily met at the instant that the vessel is directly above an object, because the distance between the object and the transducers is then equal to the depth at which the object is located vertically

below the ship. The depths of objects located vertically below a ship will be indicated by the echosounding method. But how about objects not located vertically below, but somewhere off to one side and away from the ship? To answer this question, we have to distinguish between the bottom of the sea and objects suspended or free to move in the water, such as fish.



LEVEL SEABED

The problem is simple as long as the seabed is level. The shortest path from the ship to the bottom is the vertical connection, i.e. the depth of water (1). A sound beam traveling (2 or 3) on a slant has to cover a longer distance. Echoes from objects directly below the ship will arrive before those from directions other than the vertical. Therefore, if the starting point of the overall echo is used for timing, as it habitually is, one will obtain the true depth at the ship's position.

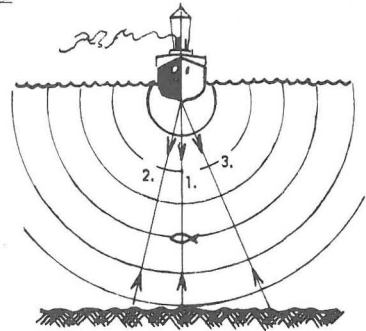

SLOPING SEABED

Things are different when the seabed slopes. In such cases, the first partial echo to arrive does not come from a point vertically below, but depending on the shape of the slope, from a point on the side (1). The echo coming from vertically below (2), which is the one giving the true depth under the keel, arrives later. It is submerged somewhere in the general echo, and cannot be identified. In cases like this, the starting point of the echoes does not indicate the true depth at the position of the ship. The depth indicated will be shallower than the true depth.

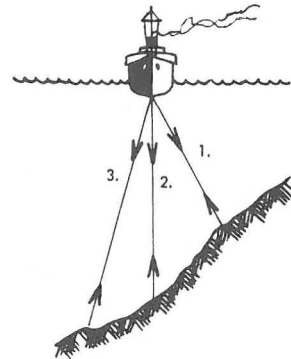

BUMPY SEABED

Similar errors occur with a bumpy seabed. If the ship, as shown in the opposite sketch, is above a narrow trough, it is possible that the trough will not be recorded at all. This is so because echoes from the edges of the trough (1 and 2) will arrive before the echoes from the bottom of the trough (3). The latter echoes cannot be separated from the volume of echoes and will be of no value for measurement. Once again the true depth of water below the ship is not indicated. A shallower depth indication results because the total volume of echoes corresponds to the transit time of the shortest path between the ship and the bottom of the sea (1). Also, the profile of the seabed will not be displayed correctly.

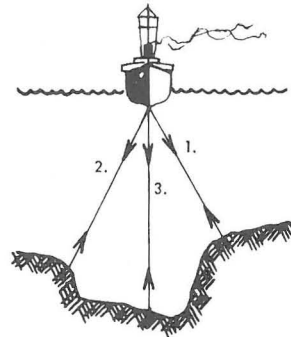

ECHO FROM FISH

What has been explained concerning bottom echoes also applies to echoproducers free to move in the water, such as fish. Only fish that are directly below the ship (1) are indicated at their true depth. Fish somewhere on the side will be shown deeper than they actually are, and continue to appear farther down as they go to the side (2,3). Because the indication of fish does not show with certainty whether they are vertically below the ship or not, it will be impossible at times to tell the true depth of a single fish or of a small shoal.

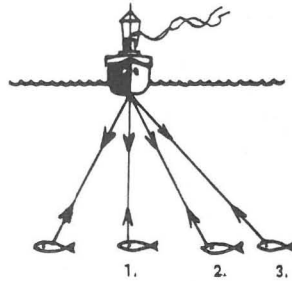

HOW TO AVOID ERRORS IN MEASUREMENT

It is evident that these errors of measurement will be greatest when sound is radiated evenly in all directions, and when echoes come in evenly from all directions, as is the case of sonic sounders operating on audio frequency. An obvious way to avoid these errors or to lessen them is by concentrating the transmitted and the received sound. This demonstrates the superiority of ultrasound over sonic sound, as, for reasons we have put forward, ultrasound can be concentrated much easier than sonic sound due to the great wavelength of the latter.

DISADVANTAGES OF SHARP CONCENTRATION

At first glance one would think that the narrowest concentration is the best means of eliminating errors of measurement. With a very narrow beam of sound transmitted vertically to the bottom, echoes would be produced vertically only below the ship, and no spurious echoes would come in from the sides. But such sharp concentration would have the disadvantage that it would not work as expected, except with the ship steady on an even keel. That, however, happens very rarely because the sea is not often as smooth as a mirror. If the ship rolls, the sharply concentrated sound beam (assuming that the transducers are firmly fitted in the ship's bottom) will follow the rolling motion, pointing alternately from side to side and rarely pointing straight down. The result would be a totally undecipherable mixture of indications of depth. This is true not only in the case of a sloping or wavy seabed, but also in the case of level ground and of fish, which makes matters worse. There is a possibility of counteracting the influence of the ship's motion by stabilizing the transducers against the ship's rolling. Remedial mechanical and electrical procedures, however, would necessitate considerable technical equipment.

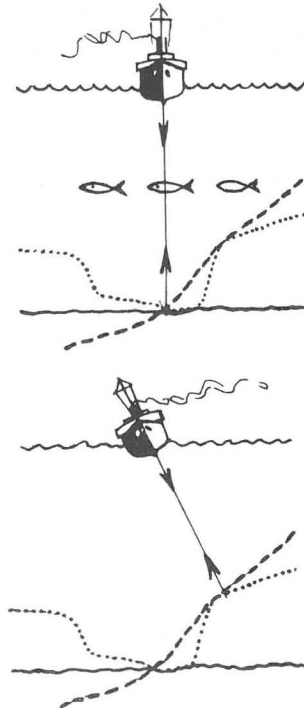

MODERATE CONCENTRATION

For the above reasons, the idea of sharp concentration has been abandoned and a compromise has been chosen. In most cases, it fulfills the demands made by navigators and fishermen on accurate measurement. This is all the more true if the user knows the weak point of his echosounder, and takes it into consideration when interpreting indications. This compromise lies between two extremes: even sound radiation and reception in all directions and narrowest concentration of the beam of sound. The modern ELAC ultrasonic echosounders do not cover the entire area of water around the ship, but only one part of it that has well defined limits. We shall call that part the effective zone or coverage.

EFFECTIVE ZONE

Coverage refers to the area of water from which under certain conditions echoes are received and indicated. Its shape and size depend on a number of conditions. To understand these, we shall have to discuss at length the operation of modern ultrasonic sounders.



SOUNDING TECHNIQUE

ULTRASOUND GENERATION

There are a number of ways to generate ultrasound, each of which has its advantages and disadvantages. The transducers employed today use either the magnetostriction effect or the electrostriction effect (piezoelectric effect).

MAGNETOSTRICTION EFFECT

Magnetostriction refers to an effect by which ferromagnetic substances, particularly nickel, or certain nickel alloys, undergo changes in length under the influence or effect of a magnetic field. Magnetic fields are easily generated electrically. They arise around any wire through which current is passed. Electromagnets are based on this phenomenon. If we take a nickel rod with a coil of wire wound around it and apply an electric pulse from a discharging capacitor, for example, the rod will contract. Though contraction is very small, it serves the purpose. When the pulse has passed, current no longer passes through the coil, and the magnetic field breaks down. Due to its inherent elasticity, the rod continues to increase and decrease in size for some time, but in diminishing amounts, until it comes to a standstill at its original length. It undergoes what is called suppressed oscillation, which, upon the pulse, begins with the greatest width (amplitude) and fades out with rapidly decreasing amplitude. It might be compared to the movement of a pendulum that has been pushed once. The whole process in the nickel rod takes place within about 1/1000 seconds.



ELECTROSTRICTION EFFECT

In transducers operating on the electrostrictive effect, a column of ceramic material (mostly barium titanate or lead zirconate) is provided with a metal layer at both front ends. If a voltage is applied to the two metal layers, the ceramic column will contract in a way resembling that of the nickel rod under magnetostrictive effect. Similarly, a damped oscillation can be generated by impulsive excitation.

RESONANT FREQUENCY

The frequency (number of oscillations per second) of such elastic oscillation depends on the length of the rod and the properties of the material of which it is made. Said frequency, being of a definite order for a specific transducer, is called resonant frequency. It is possible to make transducers of practically any resonant frequency including 30 Kcs or 50 Kcs.

RELEASE OF ENERGY

If the oscillating end of such a rod is put into water, it will transmit its energy into the water. The oscillation will spread out in the manner explained previously.

TRANSDUCERS

The magnetostrictive transducer used for echosounding today resembles a package rather than a rod. This is due to the fact that the radiating surface must be of a certain minimum size, in order to concentrate the sound sufficiently. The length of the 'rod' which is determined by the desired resonant frequency, is shorter therefore in sounding transducers than the diameter of the radiating surface. Because of design considerations, the wire is not wound around the transducer, but taken through slots. Also, to avoid eddy current loss, the metal package is not solid, but is made of laminations, insulated from one another as is done in an electromagnet or a transformer.

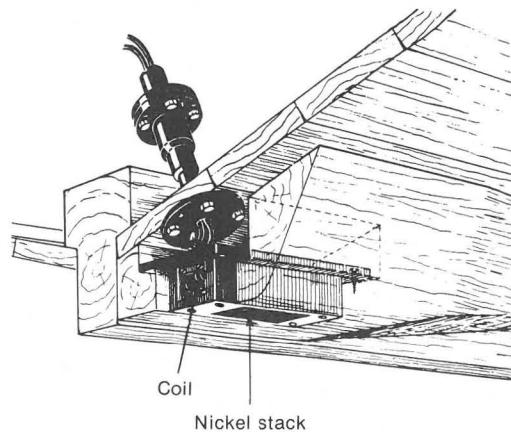

ACOUSTIC POWER

In ELAC sounders, the power necessary to generate an ultrasonic pulse varies between 100 W and 15 kW. As has previously been mentioned, the so produced ultrasonic power is about 5 Watts/cm².

When judging the effectiveness of an echosounder, the most important index is the so-called source level, i.e. the sound pressure in micropascal at a distance of 1 m from the transducer. In the logarithmic system, it is mostly indicated in decibel (db). In today's sounders, it attains

200 to 230 db.

Relative to the previous microbar unit at 1 m distance, the values were 100 db lower, i.e. amounted to

100 to 130 db.

The source level of a sounder has more important to say than the electric pulse power, because the source level also covers the efficiency and concentration capacity of a transducer.

SOUNDING PULSE

With magnetostrictive transducers it is thus possible, to easily convert an electric pulse into a damped ultrasonic pulse. In ELAC echosounders, the ultrasonic pulse lasts about 1/1000 sec. It is strong at the beginning, and it fades rapidly. If 30 Kcs are used, the electrosonic pulse of no more than 1/1000 seconds consists of 30 oscillations. The thirty waves set up an inaudible 'tone', which is strong at first but fades out rapidly.

INVERSE TRANSDUCER EFFECT

Like many other physical phenomena, the magnetostrictive effect is reversible. When a permagnetized transducer is compressed, an electric pulse is generated (induced) in the wire coil around it. The more the transducer is compressed (shortened), the stronger is the pulse. The mechanical reduction can be brought about by a blow. But it also occurs when the submerged transducer is hit by a sound wave. The crest of the wave produces a contraction, and the trough causes an expansion of the transducer. When hit by a number of waves (wave train), the transducer resonates in rhythm with the waves, producing a corresponding succession of electric pulses in the wire coil. Magnetostrictive transducers therefore can be used to convert an electric pulse into a sound pulse and, in reverse, a sound pulse into alternating electric voltage.

RESONANCE, SELECTION OF TONE



This resonance is strongest when the frequency of the arriving oscillation is equal to the frequency of the receiving transducer, or in other words, when the transducer is in resonance with the oscillation. This is true only to the extent that a transducer of 30 Kc/s resonant frequency will respond to a frequency of 30 Kc/s while oscillations of different frequencies will hardly produce any effect on the transducer. This shows that the transducer has a very strong power of selection in relation to the frequencies of arriving oscillations. It distinctly gives preference to the tone whose frequency corresponds to the transducer's own resonant frequency. That is the reason why sounders equipped with such transducers are so insensitive to interfering noise, as we have seen above.

TRANSDUCERS AND HOW TO MOUNT THEM

In modern echosounders, only one transducer is used for transmission and reception. In special cases, however, two transducers may be used. Both having the same resonant frequency, the receiving transducer responds almost exclusively to the ultrasonic pulses generated by the transmitting transducer, or to their echo. For special purposes such as surveying shallow waters, there are transducers which can be fastened outboard on any small craft. The survey sounder, for example, can be so equipped with them. Echosounding is impossible under certain conditions, particularly when the propeller is reversed or the rudder thrown over suddenly, or when the ship is rolling and pitching in a heavy sea, thus causing water containing air bubbles to be carried under the bottom of the ship. We have seen that on the border between water and air sound is reflected nearly 100 per cent. That is why great masses of air bubbles below the ship's bottom will completely stop the propagation of sound. When this condition is created by reversing the propeller, there is no remedy. But interference caused by the rolling and pitching of the ship in a heavy sea, or by high speed of the ship, can be reduced by skillful selection of the transducer mounting position. Caution should be used in selecting a position such that when the ship is exposed to a heavy sea or high speed runs, the least possible amount of air will brush by the transducers. Shipowners should consult with experienced ELAC personnel before choosing the transducer location.

The transmission pulse is a damped train of oscillation and, consequently, the echo pulse is of the same nature. The receiving transducer responds to the first wave that arrives, but does not contract strongly at first because of the inertia inherent in the material. It will, instead, rise slowly, turning itself to resonance. When the exciting sound oscillation has faded out, the receiving transducer will continue to oscillate for a short while. As a result of the rising and falling, the electric pulse generated by the receiving transducer is different and longer than the transmission pulse. It corresponds to an inaudible tone, starting low, swelling to maximum intensity and then fading out softly.



AMPLIFICATION OF RECEPTION

The electric pulse generated by a receiving transducer is, of course, very weak. To actuate an indicator it must first be amplified. In echosounders this is done by an amplifier similar to the type used in radio receivers. The degree of amplification in echosounders is controlled optionally, much in the manner as sound volume is controlled in radio sets. With low amplification only strong echoes are indicated, while with higher amplification correspondingly weaker echoes will be recorded as well. Modern echosounding amplifiers have a very high gain. In ELAC fish finding sounders, the electric energy generated by the receiving transducers can be amplified up to 100 million times. With the amplifier turned up fully, even interfering noises outside the sounding frequency are indicated. These, however, are picked up very feebly by the receiving transducers. The fact that the amplification of received signals can be controlled enables the user to choose within wide limits the degree of gain he will apply to the echoes. Success, particularly in sounding for fish, depends largely on the intelligent use made of this facility. We shall talk about this at greater length when we have completed our discussion of the function of modern sounders.

TIME MEASUREMENT AND INDICATION

Since we now have some knowledge of the techniques for the transmission and reception of ultrasound, we shall attempt to learn how the measurement of the time of transit of sound pulses is made and how the indication of echoes is presented in modern echosounders. We remember that time must be measured accurately within 1/1000 seconds ordinarily, and with 1/10000 seconds for higher requirements. We have heard furthermore that the sounding depth can be computed from the measured time of transit and the known velocity of sound. It cannot be expected, of course, that in routine soundings depth should be calculated at each individual sounding. This work must be done by the sounder, which also should indicate the result in meters or fathoms or any other unit of length in a suitable indicator. The timer, the calculating machine and the indicator form one functional unit, and in modern sounders, this triple task is actually accomplished by a single apparatus. For the measurement and calculation of time, a uniform movement of certain speed is used. Indication of sounding depth is carried out in four ways, depending on what type of indication is desired. There are now four basic types of echosounders, of which the first three are equal or similar in construction and operation.

Ultrasonic echosounders are provided with:

- | | |
|------------------------|-------------------------------------|
| (1) Flash indication | (ELAC Echometer and ELAC Echoscope) |
| (2) Scope indication | (ELAC Fischlupe) |
| (3) Graph indication | (ELAC Echographs) |
| (4) Digital indication | (ELAC Digital Indication) |

Each of the methods of indication has its own special features. Technical elaborateness, price and operating expenses differ. Apart from negligible differences of power

consumption, graph indication requires recording paper involving cost which does not occur in the other systems. In scope indication, the rather expensive Braun tube is subject to natural wear and requires to be renewed now and then. No Braun tube is used in equipment with graph or flash indications. The latter type is least costly to operate. In judging the individual value of each type, technical perfection should come first. Considerations such as purchasing price and operating cost, will also, of course, play a part in deciding which type should be bought. It should, however, also be noted that, according to the recommendations of the IMCO (International Marine Commission) and the national regulations ensuing therefrom, every ship must be equipped with a recording apparatus (echograph), designed as navigation echosounder, and fulfilling certain minimum requirements. The wide choice ELAC offers enables the buyer to select the unit that best suits his particular demands. The following is a description of the different types of indicators.

FLASH INDICATION

From the schematic drawing (see next page) the operation of this method of indication, using a luminous pointer, can be easily understood. One of the essential elements of this unit is a circular disk (3) which, like the turntable of a record player, is made to rotate by an electric driving motor (1) through an adjustable gear (2), at a definite and absolutely constant speed. This disk has a narrow slot near the edge with a small neon tube or light emitting diode (LED) (5) mounted behind it. The lamp is connected to the amplifier of the receiving transducer by means of a slide contact. The tube lights up as soon as a sound pulse arrives at the transducer. Also mounted on the axis of the disk is a cam plate (6,7) briefly closing a contact (A) at a definite moment. Contact (A) serves to release the sound pulse via a relay and an impulse circuit, thus briefly blocking the sounding amplifier, in order to suppress any spurious indication of what we will call "zero sound" (see following section).

Disk (3) rotates behind the transparent circular depth scale (4), the cam plates (6 or 7) are so set on the disk axis that the transmission contact (A) closes at the moment the slot with attached indicator lamp (5) passes behind the zero point of the scale, possibly requiring correction (see zero point setting). Thersby, the transmission pulse is suddenly released and passes through the windings of the transducer, exciting it to perform oscillations as described above.

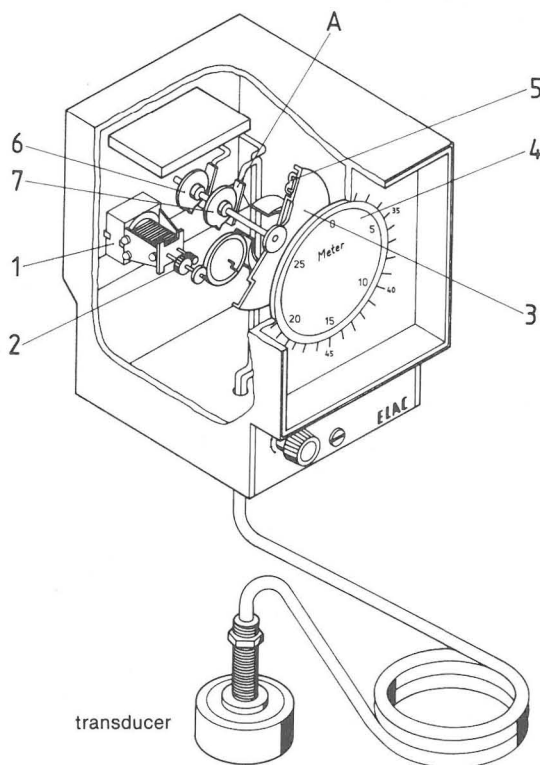

ZERO SOUND

As a result of what was explained, two things happen at the receiving end, immediately and in rapid succession: An electric pulse is generated in the receiving channel by electric action of the transmitting channel. This process is called zero sound. Normally, the zero sound would be amplified through the sounding amplifier and indicated as an echo. But in the ELAC sounders of this type it is suppressed by blocking the sounding amplifier. Timing starts at the moment of the zero sound. While zero sound is generated in the same manner in all types of echosounders, it is suppressed in sounders with flash and scope indications, but recorded in sounders with graph indication.

ZERO POINT SETTING

Depth sounding normally should refer to the surface of the water as zero point. Transducers, however, are not located at the surface, but in most cases are mounted at the bottom of a ship. Their distance from the surface of the water is approximately equal to the draft of the ship. Since it is the depth of the sea that is to be sounded, or the distance between the surface and the bottom of the sea, and not the depth below the keel, it is obvious that the submerged location of the transducers must somehow be taken into consideration. This can be done either by adding the draft of the ship to the depth indicated below the keel, or by setting the indicator so that the results include the distance from the surface to the depth at which the transducers are mounted. To achieve this, the indication at the moment of sound transmission must be moved away from the zero point on the scale to the setting which corresponds to the depth of the transducer (on the sounding scale). If the transducers are mounted at the bottom of a ship of a 4 m (13 ft) draft, the moment of sound transmission must be shifted from zero to 4 m (13 ft) on the scale. How this is done in the various sounders is of no interest to us at the moment. The Operating Instructions will give information on this point.

INDICATING TECHNIQUE

We have said that timing starts at the moment the sound pulse is released, and when the resulting zero sound comes into action. Now, while the sound pulse is traveling, say to the bottom of the sea, to be reflected and returned in the form of an echo, disk (3) with indicating lamp (5) has moved on at constant speed. When the echo arrives at the receiving transducer, it generates an A.C. voltage as described above. This voltage, amplified in the sounding amplifier, is transmitted to the indicating lamp and lights it. This short flash of light, marked on the scale as a narrow dash of light, is the depth indication for sounders of this type. The actual depth is indicated at the edge of the dash closest to the zero point on the scale.

TIMING TECHNIQUE

Since this mechanism is to be used for conducting the required time-measurement, it is necessary that the disk should rotate at absolutely constant speed. Today this is accomplished by electronic speed control of the driving motor (1). The method is similar to that used for record players. It is necessary furthermore that the speed of the disk and the ratio of the depth scale have a certain relationship. Timing can be accurate only if the rotational speed is accurate. Though this speed is set at the factory, it should be checked now and then. The procedure is simple: Check the rate of soundings with a stop watch and reset the unit in accordance with the operating instructions accompanying every ELAC sounder. This applies analogously to any type of echosounder.

We have seen that, given a velocity of sound of 1500 m/sec (820 fms/sec), the echo reflected from an object 750 m (410 fms) away returns exactly one second after the sound is transmitted. Now, let us assume that the disk makes exactly one revolution in one second and that a pulse is transmitted when that revolution starts. The echo from a distance of 750 m

(410 fms) will arrive punctually at the moment the revolution is completed. Correspondingly, an echo received from a distance of 375 m (205 fms) would cause the indicating lamp to flash after half a revolution of the disk. By dividing the circular scale into 750 equal sections, one would be in a position to read the distances of all objects producing an echo between 0 and 750 m. At each revolution of the disk, one sound pulse is transmitted. All echoes coming in from distances of less than 750 m are distinctly indicated by the indicator lamp, flashing up at the point on the scale that corresponds to the distance from where the echo is produced.

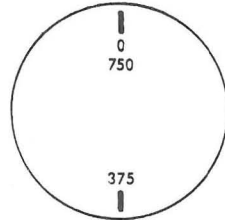

SOUNDING RANGES

The sounding ranges of the scale described will cover distances between 0 and 750 m. If we made the disk rotate at a higher speed, the range would be shorter. If it were rotated at lower speed, the range would be longer. Assuming the disk performs one rotation in half a second instead of 1 second, the sounding range of the scale will cover distances from 0 to 375 m. If one revolution were performed in 10 seconds, it would cover 0 to 7500 m (0 to 4100 fms). This fact allows to arrange flashing sounders for any required sounding range by changing the rpm of the disk and by calibrating the scale accordingly. Today flashing sounders are almost exclusively used for small craft only (yachts). As a rule, they are provided with two ranges which can be connected optionally; both of them start from 0. Thus, the ELAC Echoskop, for example, is intended to be used on yachts or small fishing craft operating preferably in shallow waters. Therefore, it has sounding ranges from 0 to 30 and 0 to 60 m.

AMBIGUOUS DEPTH INDICATION

If a sounder with flash indication and a sounding range between 0 and 200 m was operating in 250 m, the echo would not arrive before the disk made more than one rotation and the slot was at the 50 m point. In a case like this, one might have doubts as to whether the sounder was indicating a depth of 50 m or of 250 m (200 + 50 m).

If the sounding range is insufficient, echoes may also be misinterpreted in echographs. Here conditions are a little bit more complicated, because in echographs each sounding period is followed by a certain idle time before a stylus will be ready again to record. (In echographs, therefore, the bottom echo may get lost completely). Generally speaking, ambiguities will arise whenever an echo occurs in a subsequent sounding period. In actual fact, any skipper will know for certain whether at a definite place 50 or 250 m of water depth can be expected. But in difficult waters, where the depth is apt to change, this ambiguity may be confusing. If the echosounder had a sounding range of 0 to 1000 m in addition to the 0 to 200 m, one would switch the unit over to obtain unmistakable indications up to 1000 m. We have seen before that the commercial types of ultrasonic sounders are unable to sound depths greater than about 3000 m. In this case, the ambiguity referred to above could be definitely eliminated if a range of e.g. 0 to 5000 m was available. Since no echoes return from a depth of 5000 m, that range can not be exceeded, and no ambiguous indications will occur. Such long ranges, however, have two disadvantages. The accuracy of reading is low and the soundings are not repeated often enough.

READING ACCURACY

In analogously indicating echographs, reading accuracy depends on the sounding range. In a range of 0 to 200 m, a reading accuracy of 1 m is just barely possible. It is impossible in the 0 to 1000 range where the minimum accurately readable depth is 10 m. The shorter the sound-

ding range is, the greater is the reading accuracy, on the same scale. We have said that in the standard type of sounders measurements and indications can be read accurately within 1 m. To derive full benefit from the indicating accuracy of which a sounder is capable, it must be possible to read the indication of an echo with equal accuracy. That is possible with an echosounder in the 0 to 200 m range, but not in the 0 to 1000 m range. Measuring accuracy is not exploited here to its full extent. For purposes of navigation it will of course suffice. Minor inaccuracies in depth are immaterial, except where there is a danger of the ship running aground. Things are different, however, when fish are to be located. In this case, the distance between reflecting objects has to be measured. In fishing with ground trawl nets it is important to know the distance from the shoal of fish to the seabed (or the thickness of a shoal of fish), and an error of one meter or two makes a considerable difference. The same is true of hydrographic survey work where indicating and reading accuracy of 10 cm is expected. Requirement will determine which sounding range will give sufficiently accurate readings. What has been said here with respect to the dependence of reading accuracy on the size of sounding ranges also applies to the other indicators, except for digital indication. In the latter, indication accuracy depends on the unit corresponding to the last digit rather than on water depth resp. range. Only one sounding value, in general the depth of the seabed, can be indicated.

REPETITION RATE



The longer the measuring range of an echosounder is, the slower the sounding process. The number of soundings per unit of time is called repetition rate. With a 0 to 1000 m range, a sounding period lasts about 1.33 sec, and we have a maximum repetition rate of 45 soundings per minute. A high repetition rate is convenient for reading. Frequent flashes facilitate discrimination between true signals and spurious interference signals, enabling the operator at the same time to continually observe rapidly changing depth. With systems where indications are displayed on a scope or recorded on a chart, high repetition rate is particularly important. Good reading accuracy and high repetition go with short sounding ranges. Flash indication requires a long sounding range to avoid misreadings. The long range is also used for measuring greater depths. These conflicting demands are met by providing echosounders with several sounding ranges. One could even carry things so far as to equip all sounders with sounding ranges for any condition of depth occurring in navigation and fishing, thus providing the most accurate indications possible. But such universal sounders would of necessity be very expensive and, since requirements differ for navigation, hydrographic survey work and fishing, parts of the resulting complex equipment would not be used.

TYPES OFFERED

ELAC therefore presents several types of sounders assigned to different requirements, avoiding any unnecessary technical and financial expenditure. For navigational purposes on small boats, in particular yachts, a flash indication sounder will suffice. In accordance with IMCO-Recommendations, larger ships are provided with a recording echosounder, i.e. an echograph. ELAC has several type series that are adapted to the various demands in sounding performance and convenience of operation. It is possible for a digital indication device to be connected to the echographs as an accessory unit. A special unit for fishing is the Fischlupe invented by ELAC in 1949. There are different versions of it ranging from inexpensive ones to those meeting the highest requirements. We shall discuss the technical details of these types below.

CHARACTERISTICS OF FLASH INDICATION

As was said above, indication in flashing sounders is achieved by a small indicating lamp which throws a light flash at a given point on the transparent circular depth scale. Each

sounding is indicated in this way. Each flash is an indication of an individual sounding (like scope indication, but different from to graph indication). The signal flashes up once and for a very short time only, leaving no lasting trace (also like scope indication, but different from graph indication). The strength of the echo has no influence on the form of the flash indication, and no indication takes place when the echo is too weak. One cannot, therefore, draw any conclusion from the indication as to the strength of the echo. Flash indication is no indication of the echostrength (as is the case particularly with scope indication).

POSSIBILITIES OF APPLICATION, NAVIGATION

These characteristics of flash indication determine the limits of its application. It is one of the oldest methods of indication developed especially for navigation where the sounder has to indicate depth rapidly and accurately. The flash method can satisfy these requirements. It is the simplest and, consequently, most inexpensive of the three methods of indication used today.

SCOPE INDICATION

Among echosounders with scope display, the ELAC Fischlupe is the one best known. This sounder uses the trace of a cathode ray on the screen of a Braun tube for indication. Such Braun tubes are also employed in an electronic measuring instrument called oscilloscope. They are generally known as an essential element (screen) in television receivers and radar equipment. Their mode of operation will not be discussed here. It suffices to know that in tubes of this kind an electronic ray is generated and concentrated electrically. It can be moved and directed at will. The flattened screen of the tube is coated inside with a material that lights up when hit by the electronic ray. The movements of the ray, controlled in a definite way, are utilized for time measurement and indication.

The diagram (opposite) shows us how the Fischlupe functions. A constant speed controlled electric motor (4) drives a shaft which holds four cams (5-8), via a worm wheel gear reduction. With every revolution of the shaft, each cam momentarily closes a contact. When the contact of cam 5 is closed, the sounding pulse will be released via relay and pulse circuit 12. At the same instant, the contact of cam 6 briefly blocks the

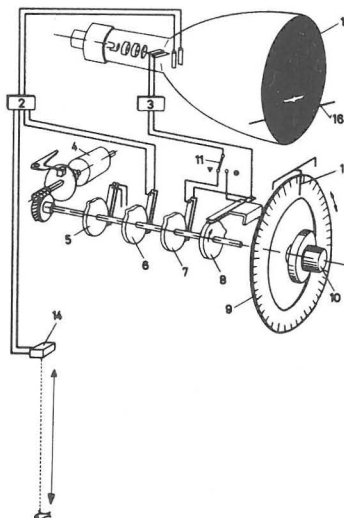
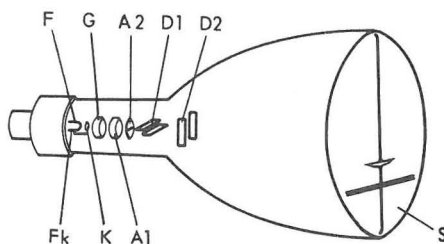

sounding amplifier (2), in order to suppress or weaken the indication of the zero sound. The contacts of cams 7 and 8 cause the controls of the cathode ray to begin measuring time. The first of these two belongs to the fixed range and closes almost simultaneously with the transmission of the sound pulse, while the second belongs to the variable range. Cam (8) is adjustable. In actual fact, a modern Fischlupe operates without mechanically moved control. Today this function is based on electronics, though the principle has not changed.

SOUNDING RANGES

The Fischlupe can operate on different sounding ranges (e.g. 5, 15, 50, 150 m). The selected sounding range can be shifted to any desired depth position by means of a scale or a digital indication. Thus, a 5 m range, for instance, can be adjusted in such a way that the depth zone of 75 to 80 m will be indicated.

Fischlupe indicators with incorporated storage can also be used in the special operation mode called 'bottom lock indication'. In this operation mode, the sounding range is automatically set so that the seabed will appear at the lower edge of the picture.

SIZE OF DISPLAY

The small sounding ranges of the Fischlupe, in particular, have an extremely high resolution. Given a 5 m range and a screen height of 20 cm, 1 m of depth will be displayed on 4 cm of screen, which facilitates discrimination of fish close to the seabed. The Fischlupe was created particularly for fishing with trawl nets. Thus, it is possible to obtain a clear picture of the water area where a trawl net fishes, and to distinctly observe the fish in that area.

REPETITION RATE

In the Fischlupe as in other indicators, only one sound pulse can be in transit at one time, in order to avoid misleading indications. The repetition rate is automatically set so as to fulfill this condition. When the Fischlupe is adjusted to increasingly greater depths, the repetition rate decreases. In Fischlupe indicators without additional storage the picture is apt to flicker. At a depth of 750 m, the picture briefly flashes up only once per second. Sounding within 20m depth, there will be 30 soundings per second and as many picture repetitions. To the eye of the observer this seems to be a steady picture. Fischlupe indicators with additional storage provide steady pictures for great sounding depths also without the troublesome flickering.

In these Fischlupe indicators, the received signal is stored in an electronic accessory unit in digital form. Then the storage contents are reproduced on the screen 50 times per second, whereby a flickerfree steady picture is generated. The picture changes with each sounding, i.e. at a depth of 750 m every second. With a special pushbutton it is possible to also suppress the picture change, thus providing for close examination of a particularly interesting sounding result over any length of time.

TIMING TECHNIQUE

Time is measured by the movements of the cathode ray. A special electrical arrangement leads the cathode ray across the scope up and down in vertical direction at a constant speed, adapted to the sounding range and the velocity of sound. The fluorescent material on the scope is illuminated where the electronic ray hits it. The illumination does not fade immediately after passing a given point. It continues, and the result is that the

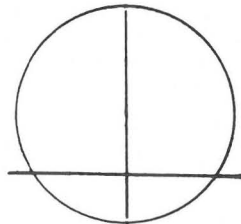

observer does not see a luminous spot in rapid motion, but a line or trace. This vertical movement of the cathode ray is released with delay when related to the instant of emission of a sounding pulse. The delay corresponds to the vertical position of the indicating range. In this way the vertical movement of the cathode ray in the variable range starts a short time before the echo comes in from the depth at which the unit is set. The vertical position can, of course, also be zero, i.e. the indicating range begins at the surface of the water.

INDICATION

In the Fischlupe the indication of echo results from the cathode ray being deflected from its vertical movement into a horizontal movement. At the moment of horizontal deflection, the cathode ray is amplified by electric means which causes the fluorescent material of the screen to assume a higher brilliance, and the echo signals become brighter and stand out more sharply in comparison with the vertical luminous line. For sounding, the top edge of the echo signal is what counts, whereas the length of lateral deflection is a measure of the strength of the echo. This type of indication, therefore, shows the strength of the echo.

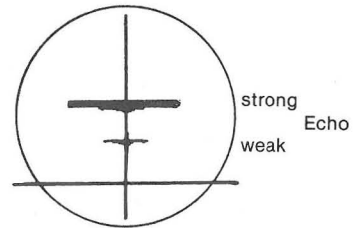

READING SOUNDED DEPTH

The scope includes a scale. To the value read from this scale, in consideration of the selected indicating range, add the adjusted depth shift in order to find out the true depth of an echo. Thus, the indicated depth value refers to the upper edge of the scope.

In the ELAC Fischlupe, the sounding is indicated by the described horizontal deflection of the cathode ray. Depth is to be read at the upper edge of the echo signal. The luminous picture of the vertically conducted ray and its lateral deflections appear at each individual sounding. Scope indication, like flash indication but unlike graph indication, gives indications of individual soundings. As these are overwritten by the next soundings, they are transitory like flash indication, but, unlike graph indication. The length of lateral deflection, i.e. the indicating amplitude, is a precise measure of the strength of a particular echo. Scope indication reproduces the echo with true strength and, in this respect, has an advantage over graph indication. This, as we shall explain, is of great advantage in fish finding. Particularly advantageous for the purposes of fishing are small indicating ranges which, because of the favorable measure of the image (1 m of depth is equal to about 4 cm on the scope), in conjunction with the fidelity of echo strength, provide very good resolution.

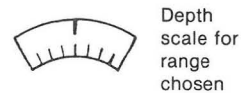
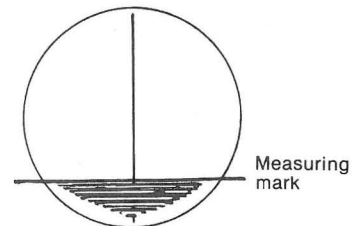

POSSIBLE APPLICATIONS

These special features of the scope indication method make the Fischlupe valuable in fish finding. And it was for this particular purpose that Fischlupe was developed. It has proven indispensable for indicating fish near the bottom of the sea and for operating in conditions adverse to sounding. The operation, and the method of applying it to fishing, as well as the interpretation of the echoes will be explained in comparison with the two other methods in a later chapter.

GRAPH INDICATION

MODE OF OPERATION

In graph indicators, as in other types discussed, time is measured by a uniform movement. The role played by the rotary disk in flash indication and by the electronic ray in scope indication is performed in ELAC recorders by an endless belt (5) running over two pulleys (3) and (4). This belt is driven by a governor controlled constant speed electric motor (1) through the lower pulley (3). Mounted on the belt, at a definite distance from each other, are a magnet (6) and a stylus (7). The magnet serves to actuate selectively one or the other of the Reed contacts (8, 9), arranged behind the belt, and by which the sound pulse is released. Which of the contacts is put in action, depends upon which sounding range is being operated. The right-hand arm of stylus (7) slides on a contact bar (13), and the left-hand arm on the recording paper. The diagram shows the arrangement of the unit. When the sounder is operated on a range beginning with O, the belt with magnet and stylus move, and the stylus is carried across the chart in a downward direction. While the stylus is passing near the top edge of the chart, the magnet closes contact (9), releasing a sound pulse. The pulse, as was explained before, produces the zero sound (at the receiver). Said pulse is amplified via amplifier (12), taken to the stylus via contact bar (13), and recorded on the chart by the stylus.

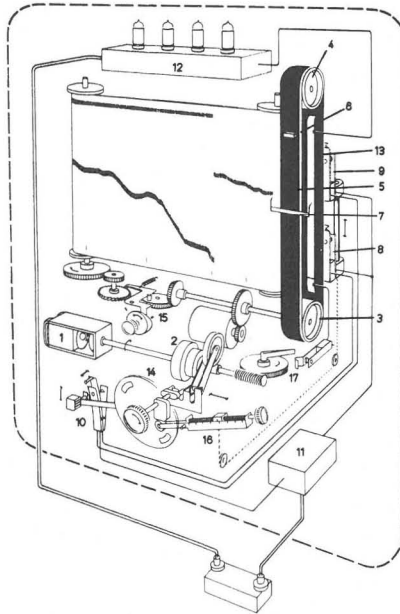

RECORDING TECHNIQUE

The pulse coming from the amplifier sparks over from the stylus to the recording paper, burning the bright surface and producing a black spot. The resulting carbon residue should be removed from time to time by means of the brush supplied with the recorder.

TIMING TECHNIQUE

Timing starts when the zerosound is triggered. It is carried out by the uniform forward movement of the stylus. The rate of stylus speed is in proper relation to the velocity of sound and the scale of the sounding range in use. While the sound pulse emitted by the transmitting transducer (S) travels to an object which reflects the echo back to the receiving transducer (E), the stylus covers a distance on the chart corresponding to the depth sounded. In the receiving transducer the incoming pulse is converted into an electric signal, which is amplified in amplifier (12) and is then taken via contact bar (13) to the stylus which marks the record (in the same manner as was done with the zero sound) at the spot that the stylus passes just then.

SOUNDING RANGES

In the ELAC recorders, the usable width of the chart is 200 mm. The point to be kept in mind when subdividing the scale is that the reading must be as accurate and the resolution as high as possible. This requires that the sounding ranges should be short. It is frequently necessary to sound great depths, and particularly in fishing, reading accuracy and resolution must be high. Here sounding technique finds itself in the same dilemma as was mentioned when we discussed sounders with flash indication. Since the majority of recorders are used for fishing, it has been ELAC'S endeavor to meet the needs of fishermen by providing the recorders with a great number of principal ranges, supplemented by intermediate ranges. In doing this, the primary object was to satisfy the needs of boats fishing with ground trawl nets. These vessels operate in fishing grounds which are selected according to seasonal conditions and which differ considerably in depth. Thus, the demands of the trawlers are not easy to fulfill. What satisfies fishermen operating with ground trawls, however, generally will suffice for any other method of fishing (drift nets, purse seines, midwater trawl nets, etc.).

DISPLAY SELECTOR

Another expedient adaptation to practical requirements is an electronic accessory unit, the so-called display selector. By means of this accessory unit it is possible to display very small ranges, e.g. 5 m, without having to use to an extremely high needle speed. Furthermore, the selected range can be shifted downward, as is the case with a Fischlupe, thus enabling the depth layer of, say, 80 to 85 m to be indicated. In the operation mode called bottom-lock indication, recording occurs in such a way that the seabed will always appear at the lower edge of the picture, irrespective of the changing depth. In another operation mode different displays become visible in the upper and lower halves of the recording paper. In the upper half, for instance, it is possible for the entire water area to be pictured as far down as the seabed, at a relatively enlarged scale, while the 5 m above the bottom of the sea are recorded by bottom-lock indication in the lower half of the paper. These effects are technically accomplished by means of a digital signal store.

ECHOGRAPH LAZ 72

The echograph LAZ 72 is primarily intended for steam trawlers. It has the following sounding ranges:

	0	1	2
I	0 - 50,	50 - 100,	100 - 150
II	0 - 100,	100 - 200,	200 - 300
III	0 - 200,	200 - 400,	400 - 600
IV	0 - 500,	500 - 1000,	1000 - 1500
V	0 - 1000,	1000 - 2000,	2000 - 3000

In the 0 to 50 m range, 1 m of sounded depth corresponds to 4 mm on the recording paper.

With this scale, sounded depth can be read accurately to within 1 m. That is possible also in the 0 to 200 m range, where 1 m of sounded depth corresponds to 1 mm on the chart. Obviously, the rate becomes less favorable as the sounding depth increases. Yet, in the 500 to 1000 range, 1 m of sounded depth still is equal to 0.4 mm on the chart, and sounded depths can, if necessary, still be read accurately to within 1 m or at least 2 m. With the display selector, it is possible for a section to be displayed at any depth and on a large scale.

ECHOGRAPH LAZ 51

The Echograph LAZ 51 is a simplified and less costly version. It is designed for use on smaller fishing craft and has 3 principal and 3 intermediate or phased sounding ranges.

SURVEY SOUNDER

The ELAC survey sounder was created especially for hydrographic survey work. Presently, it has 15 sounding ranges tuned in to the requirements for accurate measurement in shallow waters.

	0	1	2
I	0 - 20,	20 - 40,	40 - 60
II	0 - 50,	50 - 100,	100 - 150
III	0 - 100,	100 - 200,	200 - 300
IV	0 - 200,	200 - 400,	400 - 600
V	0 - 500,	500 - 1000,	1000 - 1500

In this type, 1 m of sounded depth in the 0 to 20 m or 20 to 40/40 to 60 m ranges is equal to 10 mm on the chart, while in the 0 to 50 m or 50 to 100/100 to 150 m ranges, 1 m of sounded depth corresponds to 5 mm on the chart, thus giving very high recording accuracy in shallow waters. This is necessary because, as mentioned above, in hydrographic work on rivers and in ports, it is required that depth be determined accurately to within 10 cm.

REPETITION RATE OF SOUNDINGS

In echo recorders, too, the repetition rate of soundings depends on the sounding range. As in all echosounders, no more than one sound pulse may be on its way at a time, in order to avoid misleading indications. In echographs with one recording needle, one sounding is performed at each rotation of the belt. As the stylus moves across the chart during only one third of the time of rotation, the resulting 'idle time' is relatively long, i.e. the succession of soundings relatively slow in relation to the sounding range. This may be a disadvantage in fishing, because minor fish shoals possibly remain undiscovered between soundings.

This is the reason why the larger ELAC echographs have been provided with two styli, in order to enable soundings to take place twice per one rotation of belt, thus achieving a higher repetition rate.

In shallow waters, the double echo may exercise a disturbing influence on the action of the two styli. In such a case, the second stylus can be put out of operation.

PAPER MOVEMENT

The recording paper is a tape of 25 m length delivered as a roll. It is provided for the different ELAC echographs in widths of 228 mm (9 inches) and 152 mm (6 inches). Said paper is inserted according to operating instructions. When soundings are made, it moves forward automatically from the right to the left, with the stylus moving vertically in a downward direction. In the smaller ELAC echographs, the speed of the chart can be changed in two steps, while for the larger echographs this can be done in several steps. Furthermore, the speed of the chart depends on the sounding range. For small ranges with a high repetition rate, the

number of movements is greater than it is for larger ranges with smaller repetition rates. In echographs used for hydrography the paper movement is apt to be coupled with the log, thus being proportioned to the distance covered by the ship.

The ELAC echographs are provided with a cassette for the recording paper, i.e. the recording desk with paper roll and feed mechanism can be taken from the equipment as a unit. This facilitates the change of the recording paper. A second cassette can be used for fast paper exchange.

INDICATING TECHNIQUE

We have seen that the stylus moves vertically in a downward direction across the chart which is pulled forward in a horizontal direction. Whenever a sound pulse hits the receiving transducer, electric pulses are generated in the transducer in the manner described, amplified by the amplifier, taken to the stylus, and sparked over to the chart. This sparking continues as long as the receiving transducer is oscillating. The stylus as it moves across the chart marks a line, the length of which corresponds to the length of time during which the receiving transducer is oscillating. So, on echographs, the indication of one single sounding in ranges beginning with 0 consists of a vertical line near the top edge of the chart representing the indication of the zero sound, and a number of vertical lines underneath according to how many reflecting objects are hit by the sound pulse. In echographs, the indication of a single sounding is not as impressive as in sounders with flash or scope indication. The advantage of indication by graph can, therefore, not be seen in the quality of reproduction of individual echoes, but is obvious if one looks at the recordings of a number of successive soundings. Echographs are so designed that the successive echoes are recorded next to each other, due to the movement of the chart. That is the reason why the advance of the chart is coupled with the repetition rate of soundings. Whether individual indications overlap more or less, depends on how far the paper is moved forward from sounding to sounding.

The successive movement must be so adjusted that soundings produce a continuous indication appearing separately. There is no sense in making the movement too fast. In many cases, the lowest speed at which the individual indications overlap most, will suffice. That speed is the best for conservation of paper, of course. As opposed to this, it may be preferable at times to use the highest possible speed in order to be able to follow on the graph the rapidly changing contour of the echo producer. That is why, in the ELAC echographs, the speed of the chart has been made adjustable.

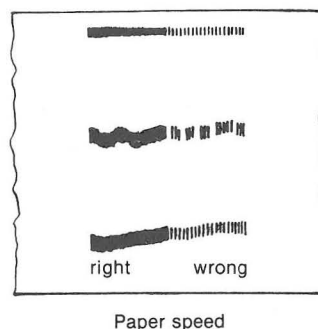
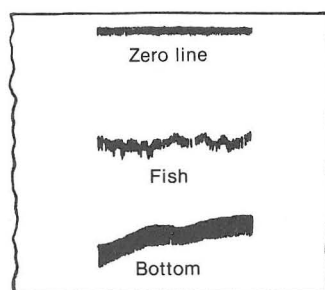

PAPER ADVANCE AND INDICATION

The distance that the chart moves has a definite influence on the indications. With slight advance, the individual indications will overlap more than they will with a wider spacing, and more sparks will hit the same place on the chart. Consequently, under the same conditions, the indication will be much darker. This is a point to remember when trying to read and interpret the record because, as we shall soon see, in echographs, the intensity of indication is a certain measure of the strength of the echo. One might be inclined to conclude from the indication of the same echo recorded with a slower chart movement that the echo was stronger than with a faster movement. This might be misleading, and one might think that the degree of discoloration of the chart was an indication of the density of the shoal of fish under observation.

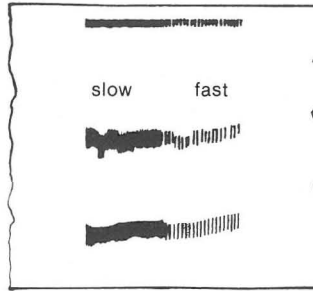

Paper advance

This is, however, compensated for LAZ 72, LAZ 51 and LAZ 50.



READING DEPTH

In all echosounders, the starting point of the echo is also the starting point for the time-measurement. This also applies to echographs. The starting point is the beginning of the vertical line which, in echographs, represents the indication of a single sounding. Therefore, the sounded depth is indicated at the top of the contour line made by a succession of individual soundings. To read this record, the ELAC echographs have a transparent scale mounted movably in front of the chart. The depth calibration lines shown on the scale are marked in different colors for each of the principal and intermediate ranges. A large window in the cover of the recorder case permits a good view at the last part of the echogram during operation. For subsequent evaluation of echograms removed from the recorder, the scale slider of every echograph can be taken out.

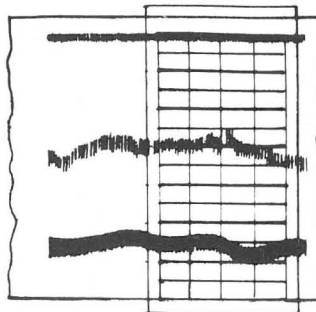

Apart from the recording of sounding results, the large echographs also record five depth lines corresponding to the water depths indicated at the automatic edge scale.

ZERO POINT SETTING

In recorders, as in other sounders, in order to measure charted depth, one must take into consideration the depth at which the transducers are mounted below the water surface. The ELAC recorders are equipped with an adjustment to compensate for this difference in depth. How this is done is explained in detail in the Operating Instructions issued with the equipment.

CHECKING ACCURACY OF MEASUREMENT

Another item that affects accurate measurement of the sounding depth is the speed of the stylus which is set and checked before the recorder leaves the factory. Normally, it should therefore not be reset. A readjustment will be necessary only after repair work or when sounding ranges are changed, e.g. conversion from fathom to metric scale. These corrections should be left to a Service technician. The ELAC survey recorder is to be equipped with a device allowing to adapt the sounder to the sound velocities varying with the different salinities and temperatures. It has already been explained in detail why this is necessary for high demands on measuring accuracy. The easy operation of this device is also explained in the Operating Instructions.

CHARACTERISTICS OF GRAPH INDICATION

In echo recorders the single soundings are recorded closely side by side. The indication of a single sounding is not very impressive and of little help in evaluating a recording. But if the indication of a succession of soundings is looked at as a whole, it presents a very clear and useful picture.

In contrast to the indicating methods described in the preceding sections, graph recording does not give indication of a single sounding, but of a succession of soundings. Also, the chart record is permanent as opposed to the indication given by the two other methods. This is of tremendous advantage in fishing and survey because it is not necessary to keep the instrument under constant observation in order to follow a series of soundings. The recorder furnishes a lasting picture of any number of succeeding soundings, available at any time for checks, comparison or subsequent evaluation. The strength of the sparks leaving their marks on the chart depends on the echo that produces them. Under equal conditions a strong echo produces a stronger spark than does a weaker echo. The stronger the echo, the blacker the indication. A graph also gives a true indication of the strength of the echo, though there are limits to this. The possibilities of shading the recorded signal from black to grey are limited, i.e., the strength of the echo cannot be reproduced to such a fine degree as is possible with the Fischlupe. Neither are the echoes of medium strength (such as from dense shoals of fish) as easily, if at all, distinguishable from strong echoes such as those from the bottom of the sea, because the echoes of medium strength might blacken the paper completely. It will be difficult under certain conditions to identify shoals of fish swimming near the bottom of the sea, because in such a case the fish echo and the bottom echo may be combined. This often occurs in rough weather when due to bad sounding conditions indications are usually rather poor.

In all ELAC echographs, the possibility of switching on the 'grey line' is a very efficient remedy in these cases. A special electronic system ensures that the seabed is recorded in light-grey and not, as might be expected of the strongest echo producer, in a deep black color. Fish near the bottom, appearing as black spot, can, even in heavy sea, easily be distinguished from the light grey recording of the seabed. Echographs of other makes mark the seabed with a white line underneath the black bottom echo. In this case, however, it is more difficult to recognize fish swimming near the bottom of the sea.

POSSIBLE APPLICATIONS



Thanks to these characteristics, graph indication, like scope indication, is particularly suitable for fishing. Sounders equipped with recorders are very useful in navigation and fish finding. The advantages of graph indication, however, differ from those of scope indication. The fact that soundings are put on record is very important. Constant observation, necessary when operating a scope indicator, is apt to be fatiguing. With echographs, a glance at the recorder at intervals of a minute or two is sufficient. This is of great value when fishing in waters where many vessels are operating in close proximity, and where the watch-

keeper has to devote the major part of his attention to navigation. Wrecks or submerged cliffs that will hang nets are clearly shown on an echograph. Echographs are also an aid in determining when the net should be hauled up. When trawling with ground nets near steep edges of coasts or banks, it is often necessary to find and follow narrow drops which may hold the biggest concentration of fish. With the aid of recorded echograms you can subsequently compare the depths where you have been fishing during a definite haul, to the size of the respective catch, and find the depths that are most promising for future hauls. Finally, echograms serve to keep the skipper informed of what happened when there was another watchkeeper. How indications are used and how they are interpreted, will be further discussed and compared with the other two methods.

INTERPRETATION OF INDICATIONS

EFFECTIVE ZONE



We know that modern ultrasonic echosounders do not emit and receive sound uniformly in all directions. In this equipment, sound is concentrated. The result of this concentration, the so-called effective zone, has been defined by us as the section from where, under certain conditions, echoes are received and indicated. The shape and size of an effective zone are determined in a very complicated manner by a series of different factors. Since the effective zone is important in interpreting indications, we shall devote some discussion to it.

SHAPE, CROSS SECTION

The form of the effective zone depends to a very high degree on the shape of the transducers and their directive characteristics. We have seen that the sharpness of concentration is determined by the relationship between the emitting or receiving transducer's diameter and by the wave length of the sound. We know, furthermore, that in ELAC sounders the emitting or receiving transducer surface is not always circular. As a result, the concentration of sound in these transducers is not equally strong in all directions. The sound is concentrated more strongly in the direction of the longer diameter of the transducers rather than in the direction of the shorter diameter. The cross section of such effective zones attainable by these transducers is neither circular (as it would be with a circular transducer surface) nor nearly so (as it would be with a square surface), but it resembles, greatly simplified, the shape of an ellipse. The long diameter of this ellipse lies in the direction of the short diameter of the transducer surface. The particular surface shape of ELAC sounders was chosen for a very good reason.

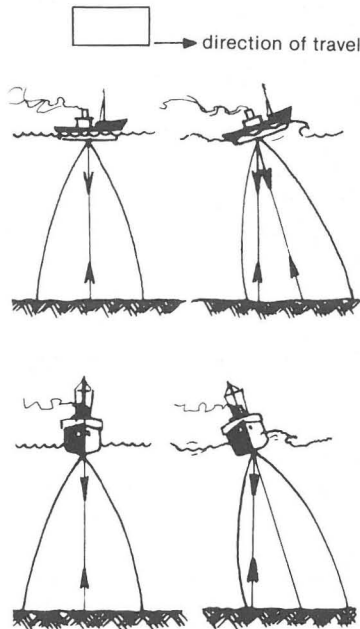

Transducers are generally mounted in the bottom of a ship with the long diameter in the direction of travel of the ship. By mounting them in this

position, it was found that depth measurements are more dependable even in heavy sea. The inclining angles, are likely to be much wider when the ship rolls, than when it pitches. Therefore, the sound can be concentrated more sharply in the longitudinal direction than in the transverse direction, without running the risk that the seabed vertically underneath the ship might not be covered by the effective zone at times when the vessel is in a heavy sea.

SHAPE, LONGITUDINAL SECTION



In the longitudinal section, the effective zones (coverage) of such transducers are of a rather complicated shape. The directional diagram shows two secondary lobes of sound radiation on either side of the principal lobe. These secondary lobes do not have any effect except in shallow water. Judging from the directional diagram alone, a longitudinal section through the effective zone should resemble the shape of a long-drawn water drop. When making measurements in natural surroundings, where the influence of sound absorption on the shape of the covered area is considered, a still longer shape was discovered. This shape was more like a cylinder with the two ends like hemispheres. Apart from the directive characteristics and the absorption of sound in water, the reflecting properties of the objects were found to have an influence on the shape of the effective zone (covered area). This shows that the highly simplifying comparison of the coverage with a cone does not give a true picture of conditions.

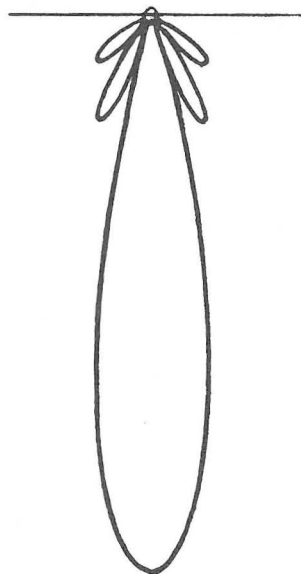

Directive pattern

SIZE



Things become still more complicated when we consider the factors that affect the size of the covered area.

TRANSMISSION POWER

The first of these factors is the energy of the sound pulse, which is given with the construction of the equipment, and does not suffer any substantial change. The distribution in space of the transmitted sound energy follows the directional diagram which shows transmission to be strongest at right angles to the radiating surface. It decreases in lateral direction. Therefore, the greatest sound strength is found in the center of the effective zone.

When comparing different echo sounders, it is not the frequently indicated electric pulse power (e.g. 2kW) which is decisive, since a high electric power may as well result in minor sounder performance, if the efficiency and concentration of the transducer are bad. The factor, however, that definitely influences the performance of an echosounder is the so-called 'source level', meaning the sound pressure at a distance of 1 m from the transducer on the principal axis. The efficiency as well as the concentration of the transducer are subject to this parameter.

PROPERTIES OF REFLECTION

The second factor, in order of importance, is the influence of the reflecting object. Based on the afore said we can derive that its size and composition, its shape and location within the covered area (effective zone) are of considerable importance to the eventual echo. Large bodies give a better echo and cover a larger space than smaller bodies. Similarly, bodies resistant to sound, such as the bottom of the sea, have better reflecting properties than softer bodies, such as a shoal of fish. Air bubbles, however, also have very good reflecting properties. More precisely speaking, the quality of echoes depends on how far the material properties of an echoproducer differ from those of water. Fish with air bladders, for example, give better echoes than, say, jellyfish. Echo producers, whose shapes, according to the law of reflection, throw back a major part of the sound that hits it to the receiving transducer as useful echoes give better echoes and wider coverage than less favorably shaped bodies. Finally, a body may be so shaped that it gives more of a useful echo when located at one edge of the covered space, rather than at the center. Also, the useful echo might be even better at the opposite edge (or worse), with the result that the covered space (effective zone) of such bodies assumes an unsymmetrical shape.

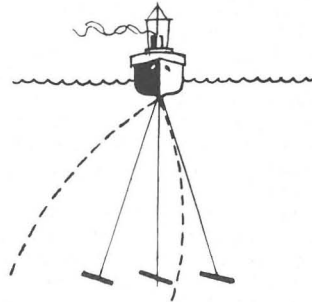
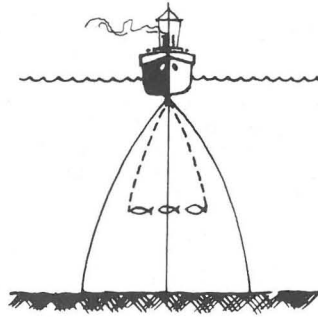

AMPLIFICATION OF RECEPTION

Another factor, strongly affecting the size of the space covered, is the amplification of reception. We have seen that it can be controlled and that we can either get an indication of strong echoes only or of weaker echoes as well. Since the transmitted sound energy decreases towards the edge of the covered area, the strength of the echo is bound to do the same. With less amplification, it is the echoes coming in from the center of the covered space that are indicated. With increased amplification, more and more echoes produced nearer the edge of the covered area may be among those that are picked up. Therefore, an increase in amplification means that there will be an increase in space covered as well.

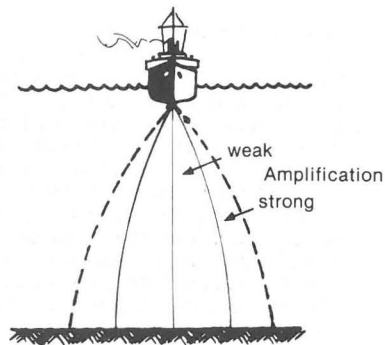

But this increase in amplification is limited by the level of surrounding noises in water areas. Whenever an echo is weaker than these general noises, it becomes unidentifiable despite increased amplification. Amplifiers in commercial echosounders approach this limit. Thus, in case of high amplification, a uniform gray fog will appear on the chart.

MAXIMUM SIZE

From a cursory study of these factors we recognize that the problem of shape and size of the covered space (effective zone) is not likely ever to be solved. A specific sounder does not have a specific coverage of its own. The factors referred to play a very important part that changes from case to case. Guided by the directional diagram, all one can say is that the coverage of a specific sounder has a given maximum size. The statements ELAC makes as to coverage and the beam width should be understood that way. Whether those are actually reached in any particular case, depends on the influence of the other factors which lie outside the sounder.

DEPTH CONSTRAINT

The lack of certainty in respect to shape and size of coverage is not of any great importance to people who use echosounders for navigation or for fish finding. But this state of uncertainty is bothersome to people who are sounding for scientific reasons. This is true particularly because the effective area or coverage has a different diameter at different depths, while there is no simple relation between the diameter of the effective area and the sounding depth. When greater demands are made, corrections by calculated values will not help matters very much. In brief, the situation is as follows: Each echo producing object covered in one and the same sounding may have a coverage of its own, different in size from that of other echo producers. Though it is true, as we shall see, that in sounding for navigation and fishing simple corrections will do, one should nevertheless study the problem of the effective zone a little more closely, in order to know more about the processes of echosounding and to avoid false conclusions.

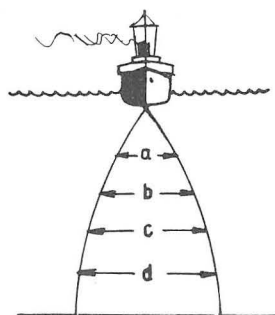

LENGTH OF ECHOES

We have seen that we cannot draw any safe conclusions regarding the shape and size of an effective area from the setting of the echosounder alone, because the other factors we have just discussed are not sufficiently known. In many cases it is possible, however, to draw conclusions from the indications, particularly so when the echoes come from an even and uniformly composed seabed. When such a seabed is sounded with the ship on an even keel, the strongest partial echoes will arrive first from a direction perpendicularly below the ship. These echoes are in the center of the effective zone. They are also the echoes that produce the sharply defined top edge of the indication of the overall echo, in any of the three methods of indication. But since the effective zone always covers a certain area, many other sound beams hit the bottom of the sea at a slant. As they deviate more from the vertical, they grow weaker at the transmitting end. They become weaker also at the receiving end, because under the law of reflection, conditions

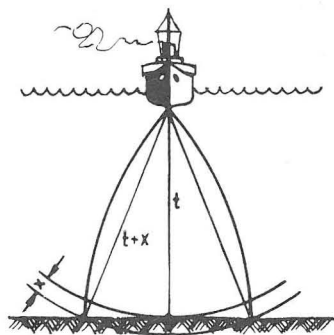

underlying the production of useful echoes become more and more unfavorable as their lateral deflection increases. The fact that laterally directed sound beams do actually produce useful echoes is due, as we have seen, to the seabed which is no ideal sound mirror, but diffuses sound reflection. The sound beam, centrally located in the effective zone, will cover the distance to the seabed and back by the shortest way and arrive first, while all the other beams have to travel over a longer route. This route grows longer as the deviation from the vertical increases, and the partial echoes will arrive that much later. Insofar as they are indicated beside the principal echo, which is the one that matters in depth sounding, they produce in the indication of the overall echo a phenomenon called echolength. We have seen that in the ELAC sounders for navigation the echolength is suppressed by a special device, whereas it is indicated in all other ELAC echosounders. The reasons for this shall be discussed below.

INDICATION OF ECHOLENGTH



The method by which the length of echoes is presented in the various systems of indication is seen from Fig. 1, a + b. The front or top edge of the indications is a reproduction of the strongest partial echo with the shortest transit time. The weaker partial echoes with longer transit times are indicated as coming from correspondingly greater depths. Since the echopulse is composed of innumerable 'soundbeams', the transition from the beams with the shortest transit time to those with longer transit times is gradual, because the space in between is uniformly filled up. If there were no interfering phenomena, the indication of the echolength reproduced true to the echostrength would of necessity show a true image of the distribution of sound in the effective zone. That is not the case, however, although we see in the Fischlupe indications which are absolutely true to echostrength, how the strength of the echoes decreases with growing transit time particularly when noticing that the lateral deflections (amplitudes of indication) become increasingly smaller. The same applies, though not perfectly, to graph indication, where the chart becomes less distinctly marked in the downward direction. In flash indication, however, the echostrength is not reproduced, as we have mentioned before. Thus, only the beginning of the echo is marked in this case.

ECHOLENGTH AND DIAMETER OF EFFECTIVE ZONE



The echolength appears in the systems of indication shown in Fig. 1 as what we should call echo thickness. It can be read from the scale of the respective sounding range in meters of sounded depth. The front or top edge of the indication tells us how long the way is which the sound beam has covered in the center of the effective zone. The end or bottom edge of the indication represents the distance covered by the beam that has travelled to the outermost edge of the zone. With these two values as a basis, we can compute the diameter of the particular effective zone. The equation according to the Pythagorean theorem is as follows:

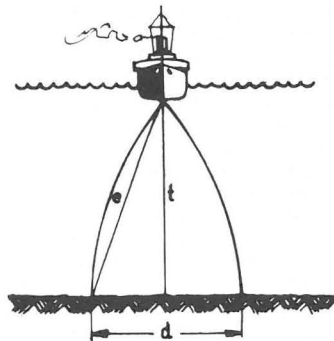

$$d = 2 \cdot \sqrt{e^2 - t^2}$$

- d = diameter of effective zone
- t = depth value of front or top edge of indication
- e = depth value of end or bottom edge of indication

This calculation includes a small error, which in turn causes the result to be a little too big. The echolength does not consist of the difference in geographical distance alone, but must include the length in terms of time of the weakest echo pulse in the particular sounding. It is hardly possible to determine the order of the error accurately. It does not carry much weight though, and we mention it merely for the sake of completeness.

INDICATIONS OF SEABED

In the discussion of effective zone and echolength, we have explained how a normal, even seabed is reproduced by the various indicating systems. Prior to discussing special cases of water depth, we have to give further explanation of this simple case of sounding technique.

MULTIPLE ECHOES

We have seen that sound is reflected almost completely at the surface of the water, which is the border between two very different media (water and air). When a sound pulse returns from the seabed in the form of an echo, only a very small portion will hit the receiving transducer as a useful echo. The major portion impinges upon the bottom of the ship around the receiver; a great portion also hits the surface of the sea around the ship and is reflected back to the bottom of the sea. There it is reflected again, and in this way the same sound pulse hits the receiving transducer a second time. If it is still strong enough, having traveled the distance twice, it will be indicated as a so-called double echo. The double echo, or first multiple echo, is below the first indication of the seabed and will appear as if it originated from a depth double the actual depth. The indication of the portion of sound that is reflected from the surface of the sea is recorded exactly at double the depth. On good-sized ships in depths that are not too great, the portion of the sound reflected by the bottom of the ship is also recorded. Since the bottom of the ship is small compared to the surface of the sea, while being a poor echo producer that reflects less sound, the double echo from the bottom of the ship is weaker. Because the distance from the ship's bottom to the bottom of the sea is shorter than the distance from the water surface to the bottom, the double echo from the ship's bottom is bound to appear in the indication on top of the double echo from the surface of the sea. The distance between the top edges of these two double echoes corresponds to the depth at which the transducers are mounted in the ship. On the basis of this value, you can check the draft of the ship. In favorable sounding conditions, the process of repeated reflections of one and the same sounding pulse may occur more often than once. Eight or more multiple echoes have actually been observed. The conditions on which the number of multiple echoes depends, and what can be deduced from them, will be discussed below. Indications from multiple echoes are particularly impressive if made by recorders, though indications of multiple echoes also occur when using other type indicators. How they appear is shown in Fig. 2, a - c.

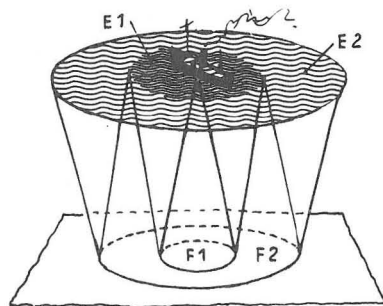

- F1 = Area hit by sound pulse.
- E1 = Area where first echo pulse can be received.
- F2 = Area hit by first reflected echo pulse.
- E2 = Area where "double echo" is received.

MULTIPLE ECHOES IN FLASH INDICATION SOUNDERS

In navigational sounders equipped with flash indicators (Fig. 2a), the multiple echoes are indicated by a flash of light appearing to be identical with the true bottom echo. They cannot be distinguished from each other by their appearance. Multiple echoes are of no use in navigation. Their indication would only cause confusion, particularly when the double or multiple distance of sounding exceeds the maximum range, and if they happen to appear on top of the true bottom echo at a shallower 'depth of water'. We have seen that multiple echoes are weaker than the true bottom echo. This difference in echo strength is considerable. Therefore, the true bottom echo will appear even when the amplification is too low for the multiple echo to be indicated. To suppress the undesirable indication of multiple echoes, one need only find out what value of amplification will be sufficient to indicate the true bottom echo, and then set the instrument accordingly. To do this, the gain control knob is turned clockwise, starting from zero, as far as the point where the true bottom echo is indicated. Conversely we can, of course, reduce any amplification which is too high by turning the knob counterclockwise until the indications of multiple echoes disappear, leaving only the indication of the true bottom echo.

MULTIPLE ECHOES IN SOUNDERS WITH FISCHLUPE

When operating with the Fischlupe, indications of the true bottom echo and the multiple echoes can be observed simultaneously in a large sounding range (Fig. 2b) only. Because of its true reproduction of echostrength, one can see in this type of indicator how the strength of echoes decreases step by step. In the smaller sounding ranges, you can observe either true bottom echo or one of the multiple echoes at a time. The instrument is set for the multiple echoes by turning the depth scale to a value which is double or a multiple of the true bottom echo. In fish finding, one will hardly ever have to face difficulties arising from multiple echoes. Interference would crop up only if the multiple echoes of a precedent sounding period should happen to coincide with the adjusted Lupe section. Such a 'phantom echo' can be made to disappear by changing the sounding range.



MULTIPLE ECHOES ON RECORDERS

We have said before that in echo recorders multiple echoes are indicated in a most impressive manner (Fig. 2c). This is one of the advantages of indication by recorders, considering the fact that important conclusions, which are essential for fish finding, can be drawn from the recorded multiple echoes.

DEGREE OF AMPLIFICATION

To further explain the multiple echoes, we shall refer to indications made by recorders. Fig. 3 illustrates the influence of amplification on the formation of multiple echo indications, all other things being equal. The higher the amplification, the weaker are the echoes picked up, and the greater is the number of multiple echoes that are indicated.

SOUNDING DEPTH

The number of multiple echo indications is also dependent on extraneous factors: The greater the water depth becomes, the longer is the distance to be traveled by the sound pulse. Since the latter is weakened by absorption while on its way, it will be so weak at greater sounding depth (after a few travels there and back) that it will not be indicated any longer. Fig. 4 shows that the number of multiple echoes decreases with increasing depth.

NATURE OF SEABED

It is obvious that the properties of reflection of the particular sounded object also exercise a strong influence on the formation of multiple echo indications. A bottom resistant to sound, such as rock, is favorable, whereas a soft bottom, such as mud, does not reflect as well, fewer or possibly no multiple echoes will be formed. This fact may be valuable in bottom trawling, because with some experience the skipper will be able to draw conclusions as to the nature of the seabed. The resistance of the seabed to sound, and consequently (all other conditions being equal) the number of multiple echo indications, decreases with the degree of reflecting power in this order: rock, sand, mud. Since it is evident that there are all kinds of transitions between these three main groups, recognition of the physical nature of the seabed will depend upon the operator's skill. The reservation 'all other things or conditions being equal' must be remembered. If, for instance, the inclination of the bottom of the sea is not the same when two successive indications are compared, then the influence exerted by the hardness of the bottom (resistance of the ground to sound) on the number of multiple echoes is overridden by the knowledge that the formation of useful echoes depends on the inclination of the bottom of the sea.



WRECKS AND PROJECTING ROCKS

There is another aspect of still greater importance to bottom trawling, which is to be taken into account when speaking of the influence of the reflecting properties of the bottom on the formation of multiple echo indications. When fishing grounds are studded with rock projections and wrecks, but provide good catches, the fisherman is often reluctant to abandon these grounds despite the risk of tearing or losing his net. In such cases, the risk can be reduced or eliminated by skillful use of the echograph. In the introductory remarks mention was made of the influence that the resistance to sound (nature of material) has on the quality of reflection, and we have just referred to its importance in the formation of multiple echo indications. Let us now recall that the order in which the sound resistance (reflection degree) of some important echo producers decreases is as follows: rock, sand, metal, wood, mud, fish, plankton. Projecting rocks will be indicated by the echosounder just as clearly as submerged wrecks. Owing to their mostly small size, however, it may take only a very restricted number of successive soundings to indicate them, and they might be covered by a shoal of fish close to the bottom of the sea, or possibly mistaken for a shoal. In such cases, graph indication is superior to other methods of indication, because for one thing, the indication of a wreck or small rock recorded in the course of a few soundings is retained and will catch the eye of the watchkeeper at his next glance at the chart. For another thing it is possible, with the aid of double echoes, to clearly distinguish such indications from indications of fish. Projecting rocks and wrecks are resistant to sound and their indication is repeated by a double echo (Fig. 5), whereas fish or shoals of fish are less resistant to sound and will give very feeble double echoes or no double echoes at all. Any distinction, however, is made safer by exploiting the 'grey line'. Wrecks and projecting rocks appear as grey as the bottom of the sea, whereas fish are recorded in black color. By checking the chart record at sufficiently short intervals (about 1 minute), the danger spot can be recognized in time and the net pulled past the obstacle by a rapid change of course. When flash or scope indicators are used, obstacles are not easily recognized. Sounders operating without permanent indication must be kept under constant observation, and danger signs may be easily overlooked because they appear for so short a time.

BOTTOM LAYERS

The difference in sound resistance of different seabeds is sometimes shown in a manner other than by the number of multiple echo indications. We have seen that when sound hits an obstacle, a portion of the sound will penetrate that obstacle, while another part is reflected at the border between the two media. Little sound, if any, penetrates hard substances,

while more sound penetrates softer matter. Therefore, while a rocky seabed is hardly penetrated, it is quite different with muddy ground. It has been found that the depth in rocky ground of very irregular and jagged outline has been built up in the course of time with deposits (mud, clay, sand, etc.), thus becoming almost level. Frequently, peaks of rocks project from such ground and endanger the fisherman's nets. While craggy areas will reflect practically all of the sound, a considerable portion of it will penetrate the softer material with which the hollows are filled. The reflected portion of the sound remains strong enough to indicate the top edge of the soft layer. But if the soft layer is not too thick, the sound that is not reflected will penetrate until it hits the underlying layer of rock. It is then reflected to give a second depth indication, which appears below the indication of the superimposed layer. This type of 'stratified indication' is well illustrated in the echogram (Fig. 6). Since the velocity of sound depends on the material characteristics of the medium, it is not the same in the covering layer (mud, etc.) as it is in water. The thickness, therefore, of such a covering layer is not indicated accurately by echosounders calibrated for water. A slight indication of its existence can nevertheless be of value in bottom trawling. It shows that the surface of the seabed is muddy in such places and further, the formation of a hard layer under the mud may be a warning that crags projecting from the ground are to be expected. Sounders operating with flash indicators do not usually give any indication of the stratification of the ground. When they do, the signals are very hard to recognize.

VERTICAL MOVEMENTS OF SHIP

Up to this point we have been considering the simplest aspect of sounding technique, where an even seabed is sounded from a ship lying on an even keel. Things are somewhat different with a ship pitching and rolling at the same time. These up and down movements, as the ship is being lifted or dropped by the waves, bring about changes in the 'depth of water'. Said movements have almost no effect when sounding with flash indicators, because the indication of depth will go up or down by no more than the actual value, and will barely affect reading even in a very rough sea. When sounding with a recorder, however, the values of individual 'depths of water' will be recorded side by side, forming a ribbon-like indication of the seabed, the top edge of which is no longer smooth (Fig. 7). From this jagged profile of the seabed, an outsider can see at a glance whether the soundings were taken in a calm or rough sea. Also, the lengths of the jags show the intensity of these vertical movements of the ship and give an indication of how rough the sea was. This jagged bottom profile does not interfere with the reading of depth, but it becomes a nuisance when fish close to the bottom of the sea are sounded. After the introduction of the 'grey line', however, any fish close to the bottom will be easily recognized also in this case. Whenever the display selector is available as accessory unit, it will be possible for the bottom to be reproduced as a smooth line without jags in the operation 'bottom-bound indication', in spite of a heavy sea.

ROLLING AND PITCHING

Rolling movements of the ship have an entirely different effect on sounding. With such movements, the strong central sound beam no longer hits a point vertically below the ship. It hits away from the ship toward the edge of the effective zone, where the beam is weaker. Since the transmitted beam is weaker, the echo beam is bound to be weaker, too. When a series of soundings is performed, the weakest echo from the seabed is expected to be reflected at the moment the heeling of the ship is strongest. Furthermore, the conditions of reflection for useful echoes will be less favorable to beams that produce the strongest

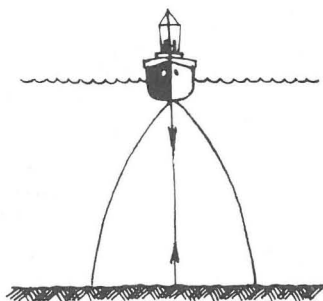

echoes. When the ship is heeling, the bottom echo, and consequently the indication of the bottom will be weaker, all other things being equal. This is noticeable particularly with Fischlupe indications giving the truest reproduction of echo strength. As the ship moves, the change in amplitude of succeeding indications is very remarkably governed by the ship's position. With the ship heeling over so much that no sound is transmitted vertically below it, the bottom indication may fail to appear at all, because the conditions of reflection are then unfavorable to the useful echo. In sounders with flash indication, these changes of echo strength are not noticeable because indications will continue, except when the echo is too weak. The same is true of recorders which are not capable of finer discrimination between echoes differing in strength, because recorders are not faithful reproducers of echo strength. When sounding in heavy sea, the graph indication (Fig. 7) is undoubtedly disadvantageous though reading the water depth is no problem at all, in spite of the jagged outline of the bottom profile.

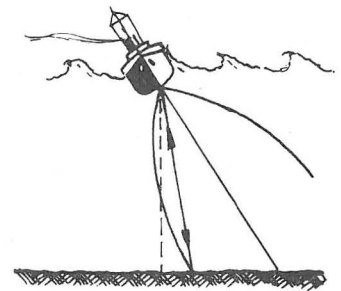
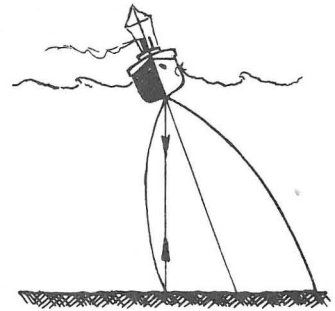

WATER CONTAINING AIR

Apart from what has been said above about reflecting conditions being changed by the movements of the ship, the fact that water containing air will be carried under the bottom of the ship is still another aspect that must be taken into account.

We have seen that air in water may hinder, or even neutralize the radiation of sound and its reception. Let us then point out in this context how important it is, when sounding in rough weather, that the transducers be mounted in the proper place at the bottom of the vessel.

ROUGH OR WAVY SEABED

There is no doubt that, except in the case of extreme heeling of the ship, echosounders will indicate the depth of water correctly when the seabed is level and smooth. If it is rubblely or wavy, even though level, the sounder will record depth less accurately. As we know, the top edge of the record is the indication of depth from the first echo beam picked up, which is the one that matters. Any signals arriving later are included in the echolength. If the size of rubble or waves is small in relation to the effective zone, the top edge of the depth measurement will be indicated at a point on the scale corresponding to the depth of the rubble peaks or the wave crests. The fact that the seabed is rubblely or wavy, rather than smooth, cannot then be seen from the indication. This is unfortunate, for it would be a great help in bottom trawling if it were possible to distinguish

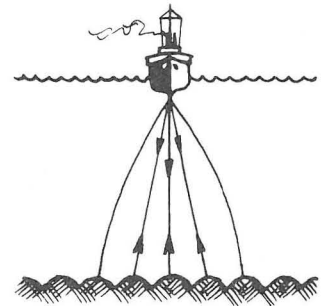

between a smooth and a rough bottom, thus avoiding damage or loss of the fishing gear. But, partly because of the nature of methods employed, echosounders are not sensitive enough as yet to indicate minor irregularities in the bottom of the sea. The degree of sensitivity depends, as we have seen, on the relationship between the irregularities of the seabed and the effective zone. Since the diameter of the effective zone (coverage) of modern echosounders in depths of 100 m may be over 50 m, uneven areas of the seabed may appear smoothed down, though they are not totally suppressed in the echo indication. This is, of course, more unwelcome in hydrographic work than it is in fishing. We have said that what is responsible for this false smoothing out of the seabed is the coverage of the sounder. By extremely narrow concentration of the sound beam this might be avoided, but we have seen that this has an unfavorable effect on the indication when sounding from a ship in a rough sea. Technically speaking, it would not be difficult to construct an echosounder operating optionally with normal or narrow beam concentration. The narrow concentration for finer recognition of the bottom configuration, however, could be successfully employed only in a calm sea. In a heavy sea, it would be of no value at all. Therefore, it is questionable whether it would pay to construct such complicated sounders. Manufacturers are not entirely convinced that this would prove satisfactory, and have refrained from developing such types. Another way of proceeding is to narrow the effective zone in standard echosounders by reducing the amplification of reception to a degree such that the strong central echoes alone are indicated. What can be achieved by this simple method with a ship lying on an even keel, is shown in Fig. 8a,b.

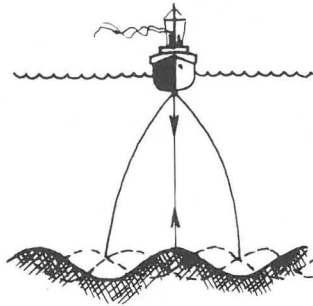

ERRORS IN DEPTH MEASUREMENT

Regrettable as it may be that echosounders do not ordinarily reproduce the details of the ground configuration, it must not be forgotten that the falsification of the indication of water depth is still within reasonable bounds and is negligible in navigation and fishing. In hydrographic survey work it must, at times, be leveled down or eliminated to a degree approaching the optimum.

SLOPING SEABED

Somewhat greater errors may occur in measuring the depth over a sloping seabed, particularly when the ship is moving in heavy sea. The extent of such errors increases with the steepness of the slopes, especially near a coastline with steep shelves. This, of course, is again based on and explained by the space limits of the effective zone of the sounder. Also, when cruising over steep ledges and sounding, the question posed concerns the depth of the water vertically below when the ship is momentarily over the ledge. It is easy to see from the sketch why under such conditions the echosounder cannot, as a rule, furnish accurate indications of depth. The reason obviously is that the important central beam (1), traveling vertically

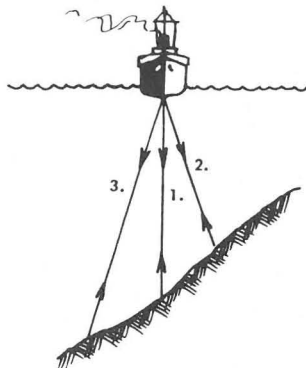

downwards, is not the beam of sound within the effective zone that has the shortest transit time when the seabed slopes. It can, therefore, never be the one appearing at the top edge of the record of the seabed. It vanishes out of sight in the length of the echo. Its place is taken by a beam of sound coming from the border of the effective zone (e.g. 2). This beam will cover the shortest distance in this particular sounding, indicating too shallow a depth of course. We know that the strength of the sound beam, and consequently that of the echo beam belonging to said sound beam, decreases as it approaches the border of the effective zone. Though in our example beam 2 has better conditions of reflection for useful echoes than beam 1 or even beam 3, it is by no means certain that the echo which arrives first is actually the strongest partial echo of such a sounding. This is because the transmission strength of beam 2 happens to be smaller. When sounding over sloping ground, it may occur that the overall echo will not start with the greatest strength and then fade, as is the normal case, but it will gradually swell.

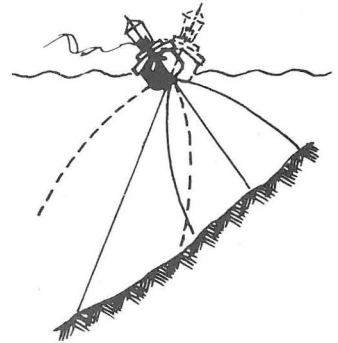

INDICATION OF SLOPES

In the case referred to above, the echo indication is of a different nature, and its effect is different with the different methods of indication. We shall use the term **SLOPE INDICATION** to denote such abnormal indications coming from sloping grounds.

FLASH INDICATION



When operating with flash indication, which does not faithfully reproduce echo strength, the abnormal shapes of the bottom echoes go unnoticed. It is the first sufficiently strong partial echo that releases the signal. If the echo from border beam 2 is too weak to release the signal, it will come from a beam between the border beam and the center beam. To the observer the indication will look perfectly normal. He will not know that the ship is in a position vertically above a steep slope and that the indication of depth is not accurate for that reason. This he will realize only if the course of the ship is set at right angles, more or less, to the sloping ground, with rapidly changing depths. But if the ship continues on an even keel along the slope, the depth indications may be about equal and may not appear different from the (accurate) indications coming from ground that is generally level. It is only when the ship is in a heavy sea that the inclination of the seabed can be noticed, because the indication of depth changes with the movements of the ship. This 'defect' is not of any great importance in navigating a ship, and consequently this method may be said to be perfectly capable of accomplishing what is required of it.

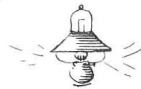

SCOPE INDICATION

The Fischlupe indicator, which faithfully reproduces echostrength, also reproduces all the details of the abnormal formation of the bottom echo. With the aid of this unit it is possible, particularly when the ship is moving in rough sea, to observe all the different kinds of echo pictures (Fig. 9, a-b). What characterizes them is the previously mentioned swelling of the echo, recognizable from the gradual growth in amplitudes of the indication in a downward direction. Furthermore, as is typical of the slope indications, they change in appearance from one sounding to the next. With Fischlupe, indications of echoes coming from sloping ground

clearly show how uncertain the measurement of depth is in sloping ground. One really is at a loss as to which part of the indication should be used to read the depth, because the distinct and strong top edge is not available. Due to this, the indication is a bit puzzling. And the attitude of many people preferring the 'definite' (but no less inaccurate) indication of flash sounders is comprehensible. The Fischlupe, however, is superior to sounders with flash indication in that its indications very clearly show whether or not one is operating above a steep slope. This fact can be valuable for bottom trawling applied in many fishing grounds where the seabed has steep slopes. In such cases, it is important that the net be kept as precisely as possible at the depth where a large shoal of fish is located. When such slope indications are observed while trawling, the skipper will know that the seabed is becoming steeper and that he will have to steer very carefully to maintain the required depth.

GRAPH INDICATION

Recorders which reproduce echostrength less faithfully cannot, of course, reproduce echoes from sloping grounds with the same faithfulness. Such echoes are recognized on the recorder by the fact that the top edge, showing the profile of the seabed, is neither clearly defined nor deep black in color. It is somewhat blurred and greyish and at times also jaggy and torn (Fig. 9c). There may be cases where the danger (referred to in our discussion of the Fischlupe indicator) of mistaking the swelling portion of the ground echo for the echo coming from fish close to the ground, is great.

MISTAKING BOTTOM ECHOES FOR FISH ECHOES



When operating with a Fischlupe, also indications from sloping ground may appear now and then, giving the impression of echoes coming from fish close to the seabed (Fig. 10). But these can hardly be mistaken for fish echoes, because they flash up only once, whereas signals of soundings before and after are unmistakably recognizable as coming from the sloping ground.

ERRORS IN DEPTH MEASUREMENT

We have already learned that the inaccuracies in indications of depth over sloping ground can be considerable. But they do not become serious in navigation or fishing. This is not so in hydrographic surveying, where one must endeavor to reduce the inaccuracies. Errors are eliminated by extremely sharp concentration, involving the use of especially large transducers. Furthermore, the sharply concentrated sound beam must be stabilized against the ship's rolling and pitching motions, in order that it may always be in a vertical position. Mechanically speaking, stabilization can be achieved by slewing the transducer, as was the case with the famous ELAC 'shelf border sounder' (NBS-equipment), or electrically, by 'phasing' the elements of a multiply subdivided transducer. In both cases, a set-point device is necessary for the momentary position of the vertical. A pendulum is used for simple applications, whereas a horizontal gyro is employed for higher demands.

INDICATIONS OF FISH



AMPLIFICATION OF RECEPTION

When dealing with bottom echoes and their indication, we found that a lot can be done by properly handling the gain control in order to reduce errors of measurement, and to make the readings of indications and their interpretation easier. This is even more important to fish finding for the very simple reason that this task in itself is technically more difficult than the sounding of the seabed.

DEGREE OF AMPLIFICATION

We have seen that fish echoes are weaker than echoes from the sea bottom. Fish are less resistant to sound, smaller in size, and shoals of fish are like sieves allowing sound to pass through. To indicate fish echoes, the amplification must be higher. It must be increased as the quantity decreases or when the fish are smaller and deeper down. It is possible for the electric signal, generated in the receiving transducer, to be amplified up to 100 million times. But with so high an amplification, noises outside the resonant frequency of the transducer (which have nothing to do with the sounding pulse) are also indicated, as we have seen before. The result is that with too high an amplification such noises will cause spurious indications which may become very troublesome when sounding for fish.

SHIP NOISE AND RANGE

Most troublesome, however, are those interference-noises that continue with about equal strength. Such noises are produced by the ship in motion, the engines, the propeller, and by turbulent water brushing against the hull, and worse still, against the transducers. The strength of these noises grows with the speed of the ship and the swell of the sea. They prevent echoes from being received because they smother the indication of the weaker echoes. Interference caused by the ship's noises largely determines the practical range of a sounder. The interference is recognizable by the fact that it extends uniformly and, independently of echo indications, over the entire sounding range. It appears below the indication of the seabed as well as above, and its strength is the same at any 'depth of water'. (If the echosounder is equipped with a depth dependent gain control, as is the case with all ELAC units, the indicated interference will appear weaker at the beginning of the sounding range. It increases as the depth is growing). Its strength depends on the degree of amplification, just as does that of the echo signal. The manner in which interferences appear in the indication depends on which method of indication is used. Since echo signals, which are weaker than signals caused by the ship as a moving entity, are swallowed up in the signals from ship noise and cannot be recognized, one should not increase the amplification beyond the point where the ship noise begins to appear in the indication. So even if efficient echosounders are employed, particularly noisy ships will be subject to a reduced sounder output and, consequently, reduced range.

SETTING FOR PROPER DEGREE OF AMPLIFICATION, SOUNDER WITH FLASH INDICATION



One cannot go that far with flash indication. Since the latter does not reproduce echo-strength faithfully, indicated interference would no longer be distinguishable from true echo indications, even if they were much stronger. In sounders with flash indication, the highest admissible degree of amplification would be the one where indications caused by ship noise are just barely avoided. For purposes of navigation, that extreme limit is not likely to be reached, except where the water depth is very great and when the ship is running at high speed. Under normal conditions, good indications of the seabed will be obtained with much lower amplification. The range of navigational sounders will be limited by ship noise in exceptional cases only. In Fig. 11a, the Echoscope shows ship noise interference with full amplification. When the gain control knob is turned counterclockwise as in this instance, ship noise interference will disappear first and multiple echoes will become visible (Fig. 11b). When turning the knob farther, the required bottom echo only will also be indicated (Fig. 11c).

FISCHLUPE

The Fischlupe indicator will display ship noise interference much more distinct, since it faithfully reproduces echostrength (Fig. 12,a-b). To be sure that no echo which can be picked

up will fail to be indicated (Fig. 12a), the gain control will be adjusted so that signals from ship noise interference barely become visible (Fig. 12b). The identifiable stronger, truer echoes are then distinguishable from signals of ship noise interference by the wider amplitude of indication. When adjusting the gain control, one must be sure that the indications for which the instrument is set originate from ship noise interference and not from an echo produced by a shoal of fish. One selects a depth setting where no fish echoes occur, and a spot free from any echo will surely be found. If necessary, one should turn the depth scale to a point below the first bottom echo.

ECHOGRAPHS



With graph indication, where faithfulness of reproduction of echostrength is limited, interference by ship noise will be recognizable when the chart is discolored all over, the discoloration being darker or lighter in shade according to the degree of amplification (Fig. 12c 1-3). This is not the case in modern echographs with depth dependent amplification where the highest permitted degree of amplification, which at the same time is the correct one for fish finding, is the one at which the paper assumes a uniformly light grey color (Fig. 12, c2). One can be certain that no true echo which can be picked up will be lost. Indications of echoes that are picked up because they are strong will appear darker than indications of interference by ship noise. The degree of interference by ship noise and its dependence on the speed of the ship are determined by the ship's shape, the depth of water, the location of the transducers, and the design of the sounder. We have described how the longest range is obtained by the proper choice of amplification. If it is desirable in certain cases to increase the range beyond that point, this can be done only by reducing ship noise interference itself. Once that is achieved, the degree of amplification can be raised again to the limit of the indications caused by ship noise interference, which is then weaker. To accomplish this, the ship's speed must be reduced, or in extreme cases, the engines must be stopped. Whether or not this action is worthwhile will depend on the value attached to soundings. Such cases may arise in connection with special survey assignments or fish finding purposes. Furthermore, it should be pointed out that it is not always useful to try and find fish when the ship is running at full speed. This is true particularly when fish are supposed to be at greater depths. Thus, white fish fishery is mainly concerned by it.

It is recommended that people using echosounders try to form a picture of how the interference by ship noise augments with increasing speed of the ship, and of the influence this has on indication, so that they will know at what speed and up to what depth they may expect fish to be indicated. Because conditions are different in every ship, no general rule can be given.

INTERFERENCE FROM OTHER SOUNDERS

Besides ship noise there are other sources of acoustic interference. Their effect, however, is much less disturbing, and they play a secondary role. We shall, therefore, mention one only: Mutual interference from two sounders operated side by side, though independently of each other.

This may happen in ships with two independent sounders, or in the case of sounders on two ships so close by each other that their soundings set up mutual acoustic interference. The latter simply arises from sound pulses and echoes of one ship being picked up by the sounder on the other ship. Such interference is particularly strong when both of the sounders operate on the same frequency. In the indicator, these parasitic echoes will look like normal echoes. In the case of sounders with different repetition rate, the extraneous indications will change their place on the depth scale irregularly from one sounding to the next. They are, however, easily recognized from this rapid change of place. But even sounders with the same repetition rate will never run in perfect synchronism and the extraneous signals will change their places as soundings proceed. The changes between soundings will not be great, but great enough to make the indications appear as interfering signals in the opposite sounder.

In echographs, these interfering signals are very plastic (Fig. 13). But it is evident that they do not seriously affect the true signals.

By a special kind of signal processing which is called 'batching', it is possible to extensively suppress interference due to other sounders as well as interference signals of static nature. This method is primarily used in horizontal locators where freedom from interference is more important than in vertical sounders.



ELECTRIC INTERFERENCE

Apart from acoustic interference, in most sounders operating at highest amplification, electric interference will also occur, with effects very similar to interference from ship noise. We have seen that modern ELAC sounders are equipped with extremely powerful amplifiers, allowing the capacity of the sounders to be utilized to the utmost limit. Such extreme amplification will cause electrical processes in the sounder to be indicated. When this happens, the top capacity of the sounder is reached. It would not be wise to amplify up to the point where the electric interference begins to become visible. But the fact that this extreme limit of power is still within the range of gain control, is a guarantee that it is possible to really exploit the acoustic capacity of the sounder to the fullest.

In case of inappropriate laying of the transducer cable, electric interference may spread to the sounder from outside. Such interference is extremely harmful as it greatly reduces the output of the unit in a way similar to the interference caused by the noise of a ship. The only remedy consists in carefully laying the transducer cable as far away as possible (at least 1/2 m) from other cables. Its best screen would be an iron tube. When discussing the general theory of sound and the laws that govern it, we saw that, with respect to conditions of reflection, there is a transition from the bottom of the sea, via shoals of fish thinning out, to the individual fish. In our discussion of the indication of fish, we shall proceed inversely, beginning with a look at conditions when sounding for single (straggler) fish).

SOUNDING FOR SINGLE (STRAGGLER) FISH

As we know, echosounders in principle measure the distances between the object producing the echo and the transducers. With the ship on an even keel, a fish located vertically below the transducers will be indicated at its true depth. Since it is located in the center of the effective zone, the strong central sound beam will impinge on it and a strong echo will return (provided conditions of reflection are good). If the same fish, under the same conditions was located at the same depth, though not vertically below, but somewhat away on the side near the border of the effective zone, it will be hit by a marginal beam. Though the fish is located at the same depth, its distance from the transducers is greater now. The beam from the place near the border has to cover a greater distance than the central beam, and the echo seems to be coming from a greater depth. Since the border beam is weaker and the conditions of reflection are less favorable for useful echoes, the fish near the border of the effective zone will give a weaker echo. Roughly speaking, the error in measurement of depth will be the greater and the echo the weaker, as the fish moves farther away from the center of the effective zone.

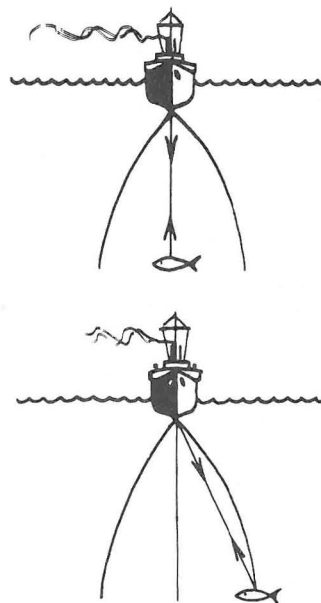

These simple facts are an important key to the interpretation of fish indications in general. It is the operator's task to draw the corresponding conclusions. A few examples will illustrate this and explain at the same time a number of typical indications of fish.

INDICATIONS OF SINGLE FISH (STRAGGLER FISH)

With the ship and the fish remaining in the same position during a number of soundings, the conditions of sounding will not change. In the Fischlupe indicator the amplitude of indication will undergo no change, showing that the echostrength does not change either (Fig. 14), while the indication remains stationary on the scope. In echographs, such a series of soundings is recorded in the shape of a ribbon, where the horizontal top edge shows that the depth is unchanged and where the uniformity of discoloration (blackening) is proof of the echostrength not being altered (Fig. 14). Though the uniformity of indication is evidence of the fact that neither the sounder nor the fish have undergone a change in their relative position, the accurate position of the fish in the effective zone cannot be derived from the indication. It is possible therefore, that straggler fish are not indicated at their true depth, but that the depth indicated is too great. It is impossible that fish be indicated at a depth shallower than the true depth, if the equipment is properly calibrated.

SHIP PASSING OVER STATIONARY FISH

Let us now assume that the ship passes vertically over a stationary fish, located at a certain depth. This is what happens: When the ship has advanced to position (1), the echo from the fish is picked up for the first time. This is the echo of a fish on the border of the effective zone, very far away from the transducers, giving a weak echo. The indication will show too great a depth. Fischlupe and echograph will indicate a weak echo (Fig. 15). As the ship proceeds on its course, the distance between ship and fish becomes increasingly smaller with each sounding. Then position (2) is reached, which is the position with the shortest possible distance when the true depth of the fish and the strongest echo will be indicated (Fig. 15). As this position is passed, said operation is repeated in inverse direction. The distance will grow from sounding to sounding and the echo will become increasingly weaker up to position (3), where conditions are the same as they were in position (1) (Fig. 15). The point is now reached where the fish is leaving the effective zone, and indications disappear. Corresponding to the number of soundings that occurred between position (1) and position (3), a series of transitions are observed between the indications (1), (2), and (3) (Fig. 15). This is distinctly exhibited on the permanent record. Opened downwards, the 'hooks' on this chart are typical of the recording of straggler (single) fish. In the Fischlupe indication, the increase and decrease in the amplitude of indication show that the echostrength changes in the manner explained. To a certain degree, this change can also be seen from the different degrees of discoloration (blackening) of the echogram.

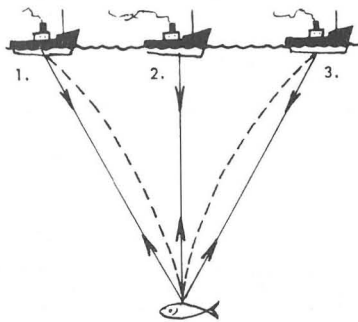

PRACTICAL EXAMPLE

Cases such as were described, where stationary fish are sounded from a ship passing over them, giving such typical indications, are frequently met with in practice. An example of this is shown in Fig. 16. The more regular the crescent-like hooks look in the echogram, and the more uniformly the up and down movement occurs, the more positive the operator can be that the fish have not changed their position while soundings were taken.

SHIP AND FISH IN MOTION

When both the ship and the fish are moving simultaneously, which case is, of course, the one to occur most frequently, sounding conditions at once become much more complex. The fact that the fish is moving can be seen from the unsymmetrical hook-shaped indications on the echogram, while with flash indications and Fischlupe the up movement takes place in a fashion different from the down movement. If you realize the innumerable possibilities a fish is offered for its movements in the three spatial dimensions, you will easily understand that there are limits to the definition and interpretation of echo indications. Ichthyologists might find it useful to study echograms in all their details to understand how fish move. Fishermen, however, are not interested in such problems, since they ordinarily will not sound for straggler fish, but for shoals of fish worth catching. We need not, therefore, elaborate on this subject. The indications of single fish (straggler fish) and the conditions for their materialization have been discussed a little bit more in detail, in order that we may lay the foundations of an understanding for indications of shoals, and because the described typical changes of indicated depth and echo strength will enable you to clearly distinguish between indications of true echoes, coming in from free water, and similar occasional indications caused by interference.

TUNA



There is, however, one variety of fish which is of importance from an economic point of view, even when encountered individually. This is the tuna. We should, therefore, mention typical tuna indications. In fishing for tuna with hand line and hook, all that the fisherman expects of his echosounder is that it will tell him whether or not tunas are present. Fortunately, tunas have a habit of accompanying ships over long distances at reasonable depths. Frequently they remain within the effective zone of the sounder for minutes, giving strong and conspicuous echoes due to their size (they measure 3 m and more in length) (Fig. 17) and movements. These indications are particularly valuable when the tunas do not disclose their presence by surfacing now and then, but remain at their depth. Without fish finding equipment, the fisherman will have to rely on his luck, throwing out his bait and hoping that there are tunas in the neighborhood, whereas an echosounder enables him to proceed actively and look for them. It is evident that he can save a lot of time and bait if he uses an echosounder.

INDICATIONS OF SHOALS OF FISH



Just as shoals are composed of many fishes, indications of shoals of fish consist of the indications caused by echoes coming from the individual fish. They are brought about simply by the echoes from numbers of fish sounded at the same moment and merged inseparably, according to the density of the shoal. No clear limit can be drawn, of course, between a compact shoal and still recognizable isolated fishes. The limits and transitions will be fluid rather than clear-cut. It also depends on the method of indication, the scale of reproduction, the size of the momentary effective zone and, therefore, on the degree of amplification and the sounded depth, up to which shoal density the echo indications of isolated fishes will be distinguishable, and where the density begins to give the impression of a solid shoal.

RESOLVING POWER

These factors may be summed up in the word 'Resolving Power', which means the ability of the sounder to indicate, for given conditions, echoes from different reflecting objects, so that they can be distinguished clearly from one another. The features essential for the resolving power of the echosounder are the duration of the transmitted pulse and the bandwidth of the receiver. To a high resolving power belongs a short pulse, accompanied by

a large bandwidth. A long pulse and a small bandwidth will favor the attainment of a major range. Consequently, a compromise is necessary. Apart from the specific characteristics of the units, the resolving power is improved by reducing the amplification of reception, the diameter of the effective zone and the sounded depth, with shoal density and other conditions being the same. We have to refrain from explaining the reasons. But the fact that this is the case must be remembered when drawing conclusions from the indications of the echoes as to how dense the shoal is. With a high degree of amplification, a large effective zone and a great sounding depth, a shoal of fish (judging from the indication) seems to be denser than it would be if the amplification was lower, the effective zone narrower, and the sounding depth shallower. If, for instance, a rising shoal of herring appears to become increasingly thinner, this does not necessarily imply that it is dispersing, but the cause may be one of the factors just mentioned. The density of a shoal of fish cannot be determined accurately from echo signals. All that can be done is to make an estimate based on experience.

INDICATIONS OF SHOALS ON FISCHLUPE AND ECHOGRAPH

We know that an indication emanating from a shoal of fish is the sum of individual indications. Fischlupe indications, exhibiting moreover the strength of echoes (Fig. 18), are formed accordingly. That is why it is possible with this instrument to clearly distinguish indications of shoals of fish from those made by echoes proceeding from the bottom of the sea. Furthermore, the Fischlupe indication enables the operator to estimate the density of a shoal of fish. With a less compact shoal, the amplitude of the indication is approximately equal to that of the indication of a single fish. In the case of dense shoals, it will occur frequently that two or more members of a shoal are at exactly the same distance from the transducers. Thus, their echoes are not only in phase, but their transit times are also equal and may be added up. Then the total echo of these fishes is stronger than the echo from the individual fish, thus producing a correspondingly wider Fischlupe indication. Compact shoals of fish, consequently give echoes producing indications of wider amplitude than do less compact shoals. In echographs, shoals of fish appear on the chart as patches or ribbons, which are blacked more or less according to the density of the shoal (Fig. 18). The density is not as easily recognized, because in the echograph the reproduction (fidelity) of echo strength is inferior to that of the Fischlupe.

DEPTH OF SHOAL

Major shoals of fish, which alone are of interest in fishing, are of a dimension exceeding, in most cases, the effective zone of the sounder, at times even to a considerable extent. The depth of their upper border is therefore indicated as correctly with the same restrictions as is the case of indications of the seabed. This depth is read in the same manner as described for reading depth of water in indications of the bottom of the sea.

THICKNESS OF SHOAL



Contrary to this, the bottom edge of the shoal indication does not, as many people think, correspond to the lower border of the shoal. Owing to the echolength in the indication of the shoal, it appears as if it were coming from a greater depth. The magnitude of the error causing the shoal to appear thicker in the indication depends on circumstances, and no definite figures can be quoted. As a rule by which to compensate for this error approximately, it is advised (simplifying the technical difficulties described) to deduct 10% of sounding depth from the indication received from the lower border of the shoal. It should be pointed out, however, that this suggestion does not cover the influence which the sounded object and the amplification of reception exert on the diameter of the effective zone, nor does it take into account the complicated shape of that zone. The fact that the lower border of a shoal of fish is indicated at excessively great depths should be remembered above all when trawling. Midwater trawls must not be lowered according to the uncorrected depth indication

of the lower border of a shoal, but instead in conformity with the depth indication of the upper border. Indications of shoals swimming close to the bottom of the sea tend to give the impression that the lower border of the shoal continues to be included in the range of the bottom trawl net. Fishermen who neglect to correct the bottom edge of the indication will be disappointed when seeing that they have been dragging in vain. Also, their estimate of the expected haul is apt to be too high, and time and money will be lost if the net is hauled too early.



LENGTH OF SHOAL

The length of a shoal of fish can be seen from the echo signals with fair accuracy. A simple calculation suffices, with the speed of the ship to be approximately known. The time during which the indication of a shoal can be observed is multiplied by the speed of the ship. The result obtained represents the length of the shoal. Assuming that the indication of a shoal stops after 5 minutes, and the speed of dragging the ship is 3 knots or about 1.5 m/sec., we shall find that the distance covered by the ship in 5 minutes (300 sec.) is $1.5 \times 300 = 450$ m.

CORRECTION

The length of the shoal would then be 450 m. Insofar as we have neglected to consider the diameter of the effective zone in relation to this particular shoal, there is an error left in said simple calculation. The sounder picks up the shoal before the ship is vertically above its front edge, and continues indicating beyond the point where the rear edge is left behind the ship. It appears from the opposite sketch that we have to deduct the (short) diameter of the effective zone from the calculated length of the shoal. But we have seen that it is difficult to know the exact value of this diameter, and we have to be content with a rough approximate correction, which will satisfy fishing needs. Simplifying things, the (short) diameter of the effective zone is assumed to be $1/3$ of the sounded depth. (In this assumption, we have omitted the influence that the sounded objects and the amplification of reception exercise on the diametrical length of the effective zone. We have purposely neglected the complicated shape of the effective zone, due to which its diameter does not grow in linear proportion to the depth. This is a very rough correction, which is certainly too small at minor depths and too great at major depths). So we have to deduct $1/3$ of the depth from the computed length of the shoal. Assuming that the shoal in our example is sounded at a depth of 150 m, we shall have to deduct 50 m, thus obtaining 400 m for the corrected length of the shoal.

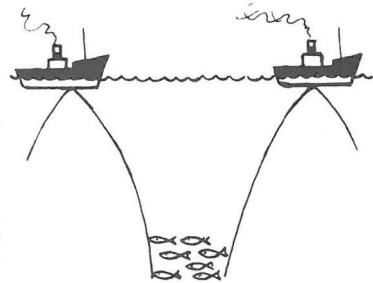

Depending on depth alone and not on the length of the shoal, this correction is of importance only in the case of small shoals, whose length is of about the same order as that of the short diameter of the effective zone. For larger shoals, as in our example, the correction is almost negligible. It is immaterial to fishing purposes whether a shoal is 450 or only 400 m long, while greater demands are often made in scientific research, where the diameter of the effective zone must be accurate in each individual case. We need not discuss this subject here.

ESTIMATING THE QUANTITY OF FISH

There is no doubt that the determination of the length and, when the ship is run on a criss-cross course, the extent of the surface of shoals of fish are an important means of judging whether a haul will pay. This applies to any method of fishing. Trawlers will try to derive

optimum tactics for fishing operations from this information. The time spent on setting and hauling nets is lost fishing time. The fisherman will therefore endeavor to haul the net home only after a sufficient quantity of fish has been caught. However, it may happen (especially when fishing for herring) that the net is dragged in the water for too long a time, and that too many fish are caught, causing the net to break. This means a double loss. For one thing the net is put out of use and must be mended, which results in additional lost time, and part or all of the catch will be lost. So it is very important to the fisherman to be able to determine the correct time for hauling up his net. In the fishing phase, this decision will be based on the interpretation of the indication of the net sounder.



SHOALS OF FISH CLOSE TO THE SEABED

Sounding for fish in free water is a comparatively easy job, whereas sounding for fish close to the seabed is much more difficult. In view of the great importance attributed to fish close to the bottom of the sea, this particular case will be discussed more in detail.

IMPORTANCE OF ECHOLENGTH

We know that shoals of fish, like the seabed, are shown in the echo indication at a length corresponding to the diameter of their effective zone. Due to this, the indications are given a certain extent in depth, which, while apt to lead to wrong conclusions in respect of the thickness of a shoal, render indications very conspicuous and visible. Demonstrated by the example of 5 fishes that are located at equal depth, but in different directions towards the transducer, the opposite sketch illustrates the formation of the echolength. If these five fishes were not located in free water but close to the seabed, the length of the echo shown in the indication would be partly fused with the bottom echo and swallowed up by it. This is what happens to the indications of the two fishes (shown in the opposite sketch) on the extreme flanks. Since fish indications that are merged with the bottom echo cannot be identified, they are lost to sounding. The result is that the effective zone for shoals of fish becomes smaller and indications are more inconspicuous as the shoals get closer to the seabed. Trawlers, however, try to catch fish close to the bottom of the sea. Furthermore, experience has shown that shoals of fish are more easily trapped and yield bigger hauls when they are closer to the seabed. It is of importance consequently that these shoals, whose upper border (herring for instance) frequently is no more than 1 m from the seabed, should be indicated by echosounders or fish finding sounders with absolute certainty. Because of their great density, these shoals often yield mass catches.

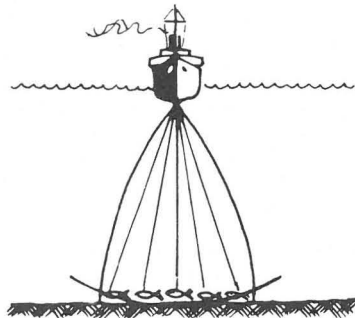
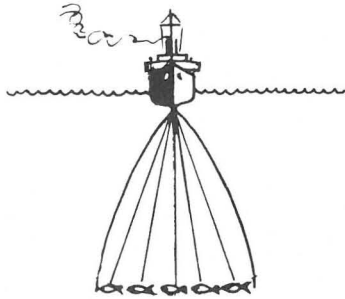

EXAMPLE

Let our example be a shoal of herring whose surface is much larger than the cross-section of the effective zone and which is of uniform density, 3 m thick, and located close to the bottom of the sea. Let us assume furthermore that it is so loosely packed as to give an echo distinctly weaker than that coming from the bottom of the sea. In our example, the ship is riding on an even keel. The echo signals to be expected are shown in Fig. 19.

FISCHLUPE INDICATION



Fischlupe's true reproduction of echostrength gives an excellent indication of the shoal (Fig. 19). Because of the width of the amplitude, the indication of the shoal can be clearly distinguished from the indication of the bottom of the sea. Since the scale of reproduction (in locator range, 1 cm on the scope to about 1 m in nature) is well adapted to the purpose, indications from a less compact shoal of not even 1 m in thickness, and close to the seabed, should still be clearly recognized.

GRAPH INDICATION

Without the 'grey line', indications of dense shoals of fish close to the seabed are hardly distinguishable from rises (rocks, wrecks). They are, therefore, apt to be overlooked (Fig. 19). With the aid of the 'grey line', incorporated in all vertical sounders of ELAC, you will easily identify any fish close to the bottom of the sea (Fig. 20).

FLASH AND SCOPE INDICATIONS IN ROUGH SEA

Things will be somewhat more difficult in bad weather when the ship is moving in a rough sea. When discussing the indication of bottom echoes, we have seen that the depth of water changes as the ship rises and falls following the movements of the sea. Water containing air bubbles is carried under the ship's bottom where the transducers are mounted, obstructing the propagation of sound and suppressing part of the soundings. This will happen to any of the three methods of indication, though the effects differ. In sounders with flash or scope indication, each sounding is considered an 'indication'. The 'changes of depth' are hardly disturbing. In Fischlupe, the 'changes of depth' can be completely eliminated in operation 'bottom-bound indication'. Soundings that are suppressed or arrive weaker are overlooked. Soundings that pass in fair condition give indications just as distinct as those obtained under favorable circumstances. The condition of a shoal of fish can be estimated if a distinct indication occurs every 5 or 10 seconds. This is true of Fischlupe, even under the most adverse circumstances.



GRAPH INDICATION

Things are different with echographs, where we have seen that the indications of individual soundings are inconspicuous, not yielding information that can be evaluated. That is why the indications of a number of successive soundings are regarded as "indication". When discussing the bottom indications, we have heard (Fig. 7) that, with a moving ship, the profile of the seabed looks jagged on the chart and shows gaps owing either to "changes of depth" or failures of echoes. With the aid of the "grey line", you will also in these cases be able to distinctly recognize the indications of shoals of fish swimming close to the seabed.

CATCHING WHITE FISH

The difficulties experienced when trying to locate fish close to the seabed are most noticeable when boats are out to catch white fish, which are normally to be found at greater depths. We know that the power of echosounders decreases with growing depth, owing to

the absorption of sound in water. The possibilities of indicating weaker echoes from fish become worse as depth increases. Furthermore, white fish do not often live in shoals as dense as that of herring and, as a rule, remain closer to the bottom of the sea. That is why white fish, particularly flat fish, are difficult to spot. It requires special care and attention not to overlook their rather inconspicuous indications.

COMBINED SOUNDERS



To allow the expert fisherman to optimally utilize the different methods of indication, one has devised a suitable combination of echograph and Fischlupe. Both units operate with the same transducer. The transmitter is located in the echograph, which also determines the repetition rate of soundings. This equipment is also termed 'tie-on Fischlupe' or 'synchro-Fischlupe' as contrasted with the so-called 'independent' Fischlupe that has a transmitter of its own, while automatically adjusting the repetition rate of soundings. This combination includes the advantages of both indication methods that favorably supplement each other, thus eliminating their disadvantages. For the time being, said combination offers the best possibilities of exploiting the method of sounding by echo to the full. It can be used by fishing vessels for navigating on their trips to the fishing grounds and back, for fish finding, and for observing shoals of fish that are to be trapped.

AMPLIFICATION DEPENDENT ON DEPTH

We know that an object located a short distance away from the transducers gives a stronger useful echo than if it is farther away, because sound is weakened on its way through water. A fish or a shoal of fish will, therefore, be indicated with more strength from a smaller depth than from greater depth, under the same conditions. This is awkward because one would like to infer the size of a fish or the density of a shoal of fish from the strength of the indication.

Apart from fish, there are other living creatures or dead objects in the sea which give echoes, if their nature differs enough from the ambient water. It is quite possible that with the highest feasible amplification recommended for use in fish finding, signals from poorer echo producers, especially those in shallower depths, will be picked up along with useful echoes. These undesirable indications do not interfere with soundings if they happen to come from sea areas that are not of momentary interest to the fisherman. If a steam trawler is searching for shoals of herring at a depth of, say, 100 m, it will not be disturbed by any echoes from a scattering layer at a depth of 30 m. (Such scattering layers will spread out in the North Sea in summer time. They form a rather sharp border between the warmer (hence lighter) surface water and the colder (hence heavier) deep water. In this layer of water, dense masses of plankton (suspended microorganisms) will accumulate with the fish that feed on them. The echo from the scattering layer is less a product of difference in density of the water but rather a factor originating in the organisms accumulated in the area). This echo may be so strong (Fig. 21, left) that indications coming from rising shoals of fish, which are of great importance to certain branches of the fishing trade, are swallowed up particularly when graph indication is used. This may be perplexing at times. But since fish, and especially big fish, give better echoes than the microorganisms of the scattering layer, it is possible by skillful operation of the gain control to attenuate indications from the layer until indications from fish stand out more distinctly. This is not simple and has the additional drawback that the range of sounding decreases in a downward direction when the amplification is reduced.

In the modern fish finding sounders (with graph indication) of ELAC, these imperfections have been largely eliminated by making the amplification of reception automatically depend on the sounding depth (Fig. 21, right). Thus, the echo of a certain fish or shoal of fish is amplified in proportion to the respective depth position of the fish or shoal of fish, so that the indications will always be of nearly equal strength under equal conditions. It is worth mentioning that, owing to this dependence of amplification on depth, the shape of the

longitudinal section of the effective zone is greatly changed, nearly resembling that of the longitudinal section of a cone. In this way, the rough correction suggested when attempting to determine the length of a shoal of fish and its thickness, is rendered a good deal more accurate. Furthermore, the interference from ship noise is not spread evenly over the entire sounding range, but becomes stronger with increasing depth. This should be remembered when choosing the proper degree of amplification.

The major ELAC echosounders offer the possibility of selecting three different kinds of amplification dependent on depth.

The gain control, subject to the mathematical theorem ' $20 \cdot \log R$ ', will be chosen whenever it becomes essential to reproduce layer echoes, such as those from the seabed or scattering layers, with the same strength and at all depth. This, for instance, applies to navigation or the reproduction of extended fish shoals at changing depth. The gain control according to formula ' $40 \cdot \log R$ ' reproduces pinpoint targets (isolated fish) of identical size with the same strength, at different depth. The third control position will enable the user to adjust a special depth-dependent amplification with two parameters, according to individual experience (A_v = strength of control; T_v = extension in time of the control range).

RECOGNITION OF SPECIES OF FISH

It would be of great advantage to the fishing trade if it were possible to draw safe conclusions from the indications with regard to a particular species of fish. From what we know of echosounders at the present time, we are inclined to think that this can materialize only on condition that certain species of fish display certain peculiarities in shoal formation and behavior. There is no doubt that such peculiarities exist with many species, and people have made every effort to utilize this fact in echosounding. But it has been found in the course of time that the shape of shoals and the behavior of one and the same species of fish may differ according to the season and to the grounds where they are caught. It would make no sense, therefore, if we tried to establish universally valid rules by which to recognize a certain species of fish from echo signals.

THE NET SOUNDER (NETZSONDE)



GENERAL

The net sounder is an aid in trawl fishing. The fact that the drag net moves several hundred meters behind the vessel, thus causing an interval to exist between what is going on under the vessel's bottom (something the vertical sounder can detect) and the arrival of the net on the same spot, explains why it is useful to verify the situation around the net with a special echosounder, the so-called net sounder. This requires, of course, that the necessary transducers be located on the net, whereas the indicator is installed on board of the ship. Normally, transducer and sounder are connected by a special cable. Another possibility is offered by the acoustic transmission of information from the net to the ship (the so-called wireless net sounder). This method has the advantage that it can do without the cable and the appropriate cable winch. The sophisticated character of the electronic system, however, is a disadvantage. This applies, in particular, to the permanently stressed and endangered underwater section in the net, which also requires a current supply of its own (change of batteries). Furthermore, the acoustic connection is less reliable than the cable. Especially in waters with pronounced layers, as they exist in the Arctic Ocean, the acoustic connection is frequently interrupted. Therefore, ELAC's net sounders use a cable connection.

OPERATING PRINCIPLE

In the simplest case, a net sounder board is tied up near the head rope of the net in such a way that the incorporated transducer will look into the net opening. The transducer is connected with an echograph on board ship by the net sounder cable. The equipment operates like a normal vertical sounder. Released by the echograph, the transmission pulse travels via the cable to the transducer in the net, where it generates the ultrasonic pulse in the water. The received echoes are converted by the transducer into electric signals, reach the receiver on board ship via the cable and are recorded by the echograph.

The transmission pulse is attenuated to a certain degree by the cable measuring up to about 3000 m in length. As the net sounder need only cover short distances (somewhat more than the net opening), the loss of transmission energy on the cable is negligible. If the net sounder is to determine the distance of the net from the seabed at not so close a proximity, it will be useful to employ a high-level power stage.

Damage to the cable will increase the attenuation. Repair work should, therefore, be performed with care. Sections with many patched spots are to be cut out if necessary.

INTERPRETATION OF INDICATIONS



The following can be recognized on a typical net sounder recording: the top rope of the net, the foot rope of the net, fish in the net opening, fish under the net and maybe also the seabed (Fig. 23). The net sounder is, of course, an important means towards the solution of a subproblem in fishing, i.e. how to make the net take up the desired water depth. On the one hand, this is done by precisely determining the distance of the net from the seabed, while on the other hand you can distinctly recognize whether the shoal of fish you are heading for appears in the opening of the net at the proper height. If necessary, it will be possible for deviations to be corrected by adequate maneuvers.

Relying on the record of the net sounder, the experienced fisherman will be able to also estimate the quantity of fish caught in the net. This requires, however, a good deal of experience, because density and extent of the recording may vary considerably according to species of fish, season, day time and fishing grounds. It may also happen that fish, swimming for a while with the net in its opening, thus produce indications that only simulate a big catch.

CATCH INDICATOR

The above-described difficulties in estimating the degree of net filling from the recordings of the net sounder recorder have led to the development of a special unit designed to exclusively induce the safe determination and indication of the degree of net filling. From the engineering point of view, this unit is an accessory part of the net sounder. Tied up at different points of the net is a switch mechanism, which responds at the respective points when the diameter of the net is increased. In ELAC's catch indicator, the response of the switches is signaled acoustically to the net sounder, where the information will be converted and transmitted to the ship via the net sounder cable. The degree of filling is shown on a special indicator.

TEMPERATURE INDICATOR



Another accessory unit of the net sounder is the so-called temperature indicator. This instrument determines the water temperature at the point where the net sounder is located, and said temperature is shown on a special indicator. It has been found out that the water temperature at net depth is an important sign of the presence or absence of fish and fish shoals in a certain area. This does not mean, however, that specific fish or fish shoals belong, as a rule, to specific temperatures. You cannot set up a rule about this, not even when taking season and fishing grounds into account. It can be rather safely assumed that productive fishing grounds detected by echosounders will finish when the thermosounder indicates the entry into another mass of water by a sudden change in temperature.

EQUIPMENT VERSIONS

The simplest net sounder operates with a transducer board supporting only one transducer. It is tied to the net in such a way as to allow the transducer to look downwards into the opening of the net. The indication is recorded by an echograph in the manner described. The transducer board of the double-beam net sounder, a more sophisticated version, incorporates another transducer enabling the user to sound the water area above the net. The distance of the net from the water surface can be measured like that. Both transducers operate on the same frequency, soundings in upward and downward direction occur alternately. When actuating a switch on the echograph, you can choose whether the sounding result of the downwards or upwards directed transducer will be recorded. The ELAC net sounder is provided with an additional scope indicator enabling the user to recognize the situation above and below the net at a glance. This scope indicator operates with a long persistence screen, thus allowing the successive and properly positioned reproductions of the soundings to give a uniform picture in both upward and downward direction.

It is well known that people fish off to the side from many shoals of fish distinctly identified in the vertical sounder. Due to the influence exercised by current, wind or course alterations, the net is not placed in the ship's keel line, but off to one side of it. The movements of the shoal of fish may also prevent the catch.

The quadruple beam net sounder tries to sound the shoal of fish also in the area between ship and net, and to catch it in the net by suitable maneuvers. For that purpose, the net sounder board is equipped with two further transducers looking ahead. The transducers operate on a frequency differing from that of vertical detection. Horizontal detection can, therefore, occur simultaneously. The two forward transducers have been adjusted so that one of them radiates a bit towards port, while the other emits rays towards starboard, with both effective zones overlapping in the center. While in operation, the transducers are alternately switched on from sounding period to sounding period. The result of the soundings are shown on the scope either to the left or right of a center beam. A target accurately ahead produces an echo indication, appearing on both sides of the center beam with the same strength. A lateral deviation of the target can be easily recognized, due to the apparent shift of the echo to the corresponding side.

FISH DETECTION WITH HORIZONTAL SOUNDERS

GENERAL

Before the fisherman succeeds in identifying a shoal of fish in the vertical sounder, he will, in general, have to search the neighboring areas of the running ship for fish and shoals of fish. This will involve the use of the sonar gear, an echosounder with a transducer which can be rotated and tilted in such a way as to allow the entire water area around the ship to be swept as if by a searchlight.

OPERATING PRINCIPLE



Horizontal sounders are based on the same operating principle as vertical sounders. A transducer is slowly suspended in such a way as to be tiltable from 0 to 90° and rotatable by 360°. An emitted sound pulse will be reflected by obstacles in the water, such as rocks or fish, and the returning echo will strike the transducer. The interval between the emission of such a pulse and reception of the echo corresponds in vertical sounding to the depth of the sounded object, whereas in horizontal sounding it serves to measure the distance from the located object.

The shape of the effective zone of a horizontally emitted sound pulse resembles that of a vertical sounder. Theoretically speaking, it would appear to be advantageous if the aperture angle in both the vertical and the horizontal plane were designed to be as small as possible,

thus enabling the user to determine the exact size of a sounded shoal of fish as with a sharply directed searchlight. Practice has proven, however, that the use of such a sharply concentrated beam is unadvisable, considering that it will follow every roll and pitch of the ship, thus causing a sounded target to be easily lost again. The shape and size of the effective zone of a horizontal ultrasonic pulse is, therefore, determined by a compromise between the requirements of practice and the theoretical possibilities though the latter may at first glance appear more advantageous. There is a further aspect influencing the selection of the aperture angle of the effective zone: sharply concentrated sound beams require large transducers. This would involve certain restrictions for naval architectural reasons. Further considerations concern the horizontal aperture angle of the effective zone. Supposing a vessel in motion wants to scan the sea area ahead over a large distance, say 2000 m. Here the searching must proceed at a certain speed in order to enable the respective sea area to be scanned before the ship reaches it. Previous to turning the transducer a few angular degrees in the interval between two soundings, however, you have to wait until the emitted pulse has travelled to and returned from the target at a distance of 2000 m.

The rotation of the transducer can be sped up in proportion to the increased width of the horizontal aperture angle of the directivity pattern, thus allowing a proportionally wider angle and consequently larger sea area to be covered in one single sounding. On the one hand, therefore, it is necessary to keep the horizontal aperture angle as small as possible in order to achieve the highest possible accuracy, and on the other hand it is desirable to choose the widest possible angle, in order that the largest possible sea area be scanned and the transducer be turned faster in the interval between two soundings.

Furthermore, it must be considered that the emitted sound energy, in case of stronger concentration, will be more sharply focused within the narrow effective zone, than in the opposite case when being emitted in moderate concentration in a correspondingly wider angular range. A sharper concentration of the sound power naturally results in a greater range.

SPECIAL FEATURES OF HORIZONTAL SOUNDING EQUIPMENT



A horizontal sounder differs in two important points from a vertical sounder, namely with regard to the optimum frequency and the length of the sound pulses.

SOUND WEATHER

In the foregoing, a phenomenon generally called 'sound weather' has been disregarded. The sea does not consist of one homogeneous mass of water, but is rather divided into a number of water layers, which differ from one another in salinity and temperature. Lying mostly horizontally, these layers do not present any difficulties when being sounded vertically. The sound pulse hits these layers at an angle of approx. 90° and thus easily penetrates them. At times, the vertical echogram will record such a layer called 'scattering layer'. Thorough investigations of the sea depths and accurate measuring of the temperature have established that small organisms (plankton) preferably live on the border between two such layers of water. These organisms may also cause more or less distinct recordings to appear in the echogram. For horizontal sounding these layers of water present certain difficulties. Horizontally emitted sound pulses no longer strike such a layer at an angle of approx. 90° but at a much smaller angle. As a result, parts of the emitted sound energy are either reflected by this boundary layer (the angle of incidence is equal to the angle of reflection) creating an echo which is lost somewhere in the sea, or the sound pulse is deflected downwards, thus causing the range to be drastically shortened. Such layers occur in various forms at different times of the year or even the day. This explains the expression of 'sound weather' apt to change from one hour to another like the weather.

Investigations in practice and theory have established that a decrease in transmitted frequency will result in increasing the range of a horizontal sounder, since absorption as well as dispersion of the sound waves rise with higher frequency. This is easily understood when you realize that indications obtained from small objects are the better the higher the transmitted frequency. This subject has been discussed earlier in this booklet. It will, therefore, be easier to detect plankton with a 50 kc/s rather than with a 30 kc/s sounding equipment. But especially in horizontal sounding it is highly undesirable to get indications of plankton or other floating particles in the echogram. In theory it is possible to use a very low frequency. In view of the necessary concentration, however, the transducers would have to be increasingly larger in size. Thus, the limit with respect to size and cost would soon be reached. The Honeywell-ELAC LODAR equipments operate on frequencies between 20 kc/s and 50 kc/s, with the high frequencies belonging to the small sounders, which are compact and have a limited range, while their resolution is high. In low frequencies, however, the bigger wide sounders achieve a wide range, though at the price of major dimensions and more refined sophistication.

A further attempt to increase the range is to extend the length of the sound pulse. Opposed to vertical sounders, where the sound pulse should be as short as possible in order to obtain the most distinct indications and to increase the resolving power as much as possible, horizontal sounders require longer sound pulses. This will be clearly understood when bearing in mind that a long pulse carries more energy to penetrate the water even under unfavorable dispersion conditions. Consequently, the energy contents of the pulse is increased by this measure. Naturally, there are limits here, too, because the more the length of a sound pulse increases, the longer becomes the indication of its echo and the less distinct is the recording of, say, two shoals of fish located one close behind another. The echoes of these two shoals of fish would merge into one if too long a pulse were used. Furthermore, a longer pulse allows for an acoustic indication to be formed. This will be discussed in the following.

SET UP OF A HORIZONTAL SOUNDER



The simplest horizontal sounder (ELAC-Mini-Lodar) consists of two units only. One is the indicating and control unit incorporating the pulse generator, amplifier, scope indication as well as all check and operating elements.

The second unit is the 'hoist-sweep-gear'. It consists of a shaft which carries the transducer at its lower end. This shaft is led through a gasket fitted in the ship's bottom. The shaft with the transducer can thus be raised or lowered. A ball supporting the transducer is mounted at the lower end of the shaft. The ball ensures a smooth flow around the transducer and avoids cavitation. Furthermore, the transducer as well as the tilting and rotating mechanism are protected by the ball from the aggressive influences of the sea water. The transducer is tiltable, permitting sound pulses to be emitted in the horizontal direction and, after tilting the transducer by 90°, also in the vertical direction. With this arrangement it is possible to sound through the entire space of water around the ship.

The functions of the latter unit, tilting and rotating movements of the transducer as well as raising and lowering motions are remotely controlled switches on the indicating and control unit. Rotating also includes an operation where a certain sector is scanned automatically.

Considerably more extensive and naturally more powerful are the large horizontal sounders. With the ELAC-Superlodar, for instance, transmitter and scope indicator are incorporated in two separate cases, while the operating unit contains an echograph and a loudspeaker as integrated indicating elements. It was necessary to use a sturdy hoist-sweep-gear for the large transducer ensuring good concentration, in spite of a relatively low frequency of 20 kc/s. The operating principle of the Superlodar, however, does not differ from that of the small horizontal sounder.

ECHO INDICATION



Indicating elements for horizontal detection are graph indication, the scope as well as an acoustic signal. The technique of graph indication is equal to that of vertical sounders. The distance of an echo from the zero line, however, does not correspond to the depth of the shoal of fish but to its slant range. When the ship is approaching the shoal of fish, the slant range becomes increasingly shorter, i.e. the target stands out as a line slanting upwards.

The scope indication is similar to the reproduction on a Fischlupe insofar as echoes are also indicated by the characteristic deflection of the cathode ray at right angles to a central beam. The central beam itself, however, is spatially not established, but revolves on the scope synchronously with the rotating transducer. Given the long persistence scope, an approximate radar-like reproduction will result from automatic rotation. The scope indication furnishes, at a glance, information about direction, distance and strength of an echo.

These two indicating methods used in vertical sounding are supplemented in horizontal detection by an acoustic signal. In the process, the received echo signal is translated in a special receiver section from its ultrasonic frequency range into the sound range audible to people; it is reproduced by an incorporated loudspeaker. This is not a more or less superfluous gag, but involves the obtaining of valuable additional information. The human ear can clearly distinguish the echoes of different targets thanks to their varying tone. Whereas optical indications hardly permit to distinguish the echo of a ship's propeller water from that of a shoal of fish, the fisherman's ear will undoubtedly discern certain differences.

In general, all three methods of indication are used for the detection of shoals of fish. In the searching phase, the fisherman will allow his sonar device to automatically rotate in a certain sector ahead (e.g. from 45° port to 45° starboard), while paying attention only to the acoustic signal. For a long time and at regular intervals, he will only hear the tone of the radiated transmission pulse. But as soon as, though feeble at the beginning, the typical 'ping' of a fish echo becomes recognizable, he will switch off the automatic rotation and try to accurately spot the echo according to the direction of rotation and tilt. In this early phase of identification, the graph indication is an indispensable aid. As the echo is weak on the border of the range, appearing only now and then, its pursuit on the scope is difficult and frustrating. The echograph, however, will permanently record all of the incoming echoes arriving irregularly, at the beginning, and soon the observer will be able to recognize, in spite of the gaps, the picture of the line slanting upwards. The coincidence in time of tone and recording will aid the fisherman in finding the recorded shoal of fish on the recorder.

As soon as the echo has become stronger and regularly appears in each sounding period, it will be accurately spotted by manually operating the rotatable and tiltable gears. The alterations in echo strength are distinctly shown by the scope indicator, thus permitting easy maximum sounding.

The volume of the acoustic signal can also be used for maximum sounding. In general, the fisherman will now change the course of his ship in such a way that it is headed directly for the shoal of fish spotted right ahead. Depending on to the depth of the shoal of fish, the time will come after further approach when the target drops out of the effective zone of the transducer, in downward direction, i.e. the echo will more or less rapidly disappear from the indications.

The indication can be recaptured by tilting the transducer. Except for 2 to 3 degrees, the tilting angle can be determined precisely by careful observation of the echo strength. The depth of the shoal of fish is ascertainable by calculation from tilting angle and read slant range. ELAC's major sonars facilitate this calculation by a graphic depth computer integrated in the tilting angle indication.

THE CATCHING PROCESS IN PURSE SEINE FISHING

The computation of the depth of fish from slant range (distance) and tilting angle is particularly important to the purse seine fisherman, because he will, in general, avoid passing over the shoal of fish. He has to know whether the shoal of fish is still located within the catching range of his net. In that case, the purse seine fisherman will begin to set his net around the shoal of fish. Moving his sonar through 90° on the side where the shoal of fish is located, he will maneuver his boat in such a way as to keep constant distance from the center of the shoal. Having covered half of the circle, the sonar set frequently shows his own net behind the shoal of fish. This will enable him to better judge the paying-out process.

During the paying-out process, the fisherman will anxiously observe the vertical sounder until the net is closed, since fish indications in this period may signify that parts of the shoal of fish escape by passing below the boat. If necessary, means of frightening the fish into the net may be employed in the final phase of the paying-out process (e.g. flashlight).

THE CATCHING PROCESS IN TRAWLING



In general, the trawler will pass over the shoal of fish in order to sound the accurate depth of the shoal by means of the vertical sounder and Fischlupe. Changing the boat's speed, the fisherman will adjust the net to the measured depth of the shoal of fish. Until the net reaches the shoal of fish, the sonar set may follow the latter also sternwards, given especially favorable conditions. Occasionally the net itself may be detected. Difficulties when using the sonar gear in stern directions will arise from interference through the ship's propeller noise and the elimination of the targets by the propeller water.

Therefore, the net sounder is the determining factor for the catch. The recordings of the net sounder clearly show whether fish have been detected at proper fishing depth. The filling of the net and, consequently, the right moment for hauling home will finally be signaled by the net filling meter.



FIGURES

Fig. 1a	Indication of echolength on Fischlupe	63
Fig. 1b	Indication of echolength on Fischlupe	63
Fig. 2a	Double echo on Echometer	64
Fig. 2b	Double echo in fixed range of Fischlupe	64
Fig. 2c	Double and triple echo on echogram	65
Fig. 3	Multiple echo with varying degrees of amplification	66
Fig. 4	Decrease in number of multiple echoes with increasing depth	66
Fig. 5	Indication of wrecks, rock peaks and fish in echo and double echo	67
Fig. 6	Indication of bottom layer on echogramm	68
Fig. 7	Echogram taken during a heavy sea	69
Fig. 8a	Indication of formation of ground at high gain	70
Fig. 8b	Indication of formation of ground at low gain	70
Fig. 9a + b	"Slope indication" on Fischlupe	71
Fig. 9c	"Slope indication " on echogram	72
Fig. 10	"Slope indication" on the screen of Fischlupe	72
Fig. 11a 1-3	Setting of correct degree of amplification on ELAC-Echometer and ELAC-Echoscope	73
Fig. 11b 1-3	Setting the correct degree of amplification on ELAC-Fischlupe	74
Fig. 12	Setting the correct degree of amplification	75
Fig. 13	Interference caused by simultaneou operation of another echosounder	76
Fig. 14	Indication of single fish on the screen of Fischlupe	76
Fig. 15	Indication of single fish on the echogram	77
Fig. 16	Fish and ship are changing their position; indication of single fish	78
Fig. 17	Indication of single fish on the echogram: Thuna	79
Fig. 18	Indication of shoals of fish on the echogram	80
Fig. 19 a	Indication of shoals of herrings, ship not moving	81
Fig. 19 b	Indication of shoals of herrings, ship not moving	82
Fig. 20	Indication of bottom fish on echogram and simple recognition because of setting the grey-line	83

Fig. 21(r)	The time sensitivity control in dependence on the depth of sounding cause the effect of nearly constant intensity of indication .	84
Fig. 21(l)	Indication of scattering layer on echogram	84
Fig. 22	Elimination of undesirable indication of scattering layer through the time sensitivity control in the ELAC-echograph; only indication of fish in scattering layer	85
Fig. 23	Netsounder	86
Fig. 24	Cable winch	86
Fig. 25	Directed fishing with horizontal (1) and vertical (2) echosounding and netsounder (3)	87
Fig. 26	Netsounder echogram	88

Fig. 1a
Indication of echolength
on Fischlupe

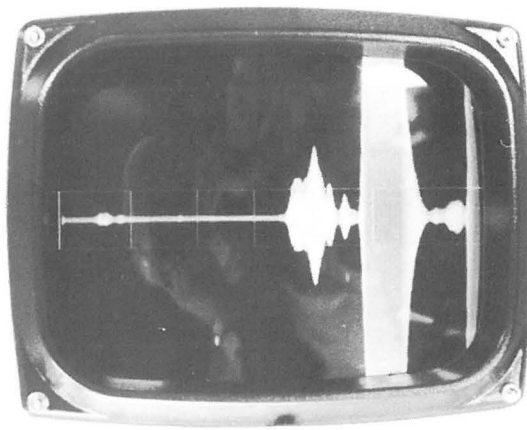

Fig. 1b
Indication of echolength on
Fischlupe

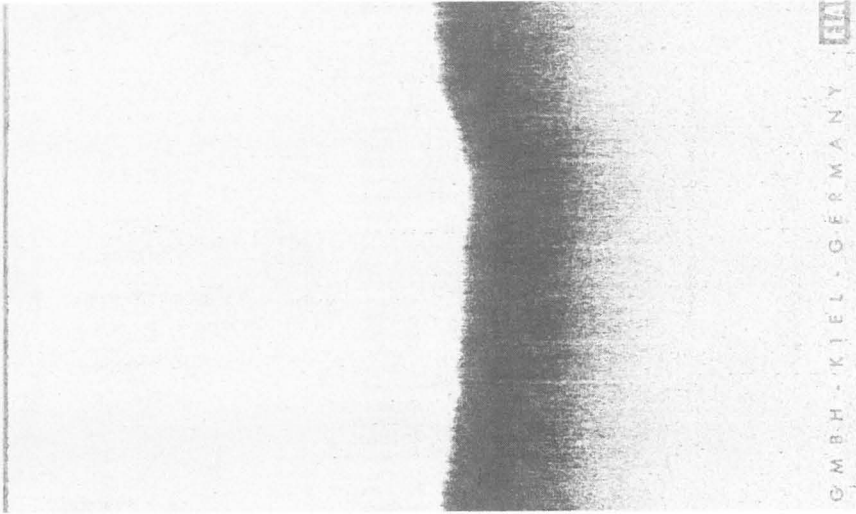

Fig. 2a
Double echo on Echometer

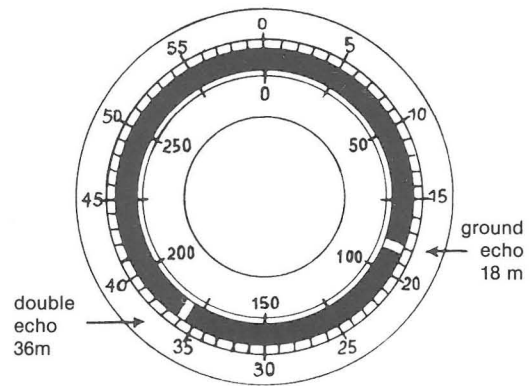

Fig. 2b
Double echo in fixed range of
Fischlupe

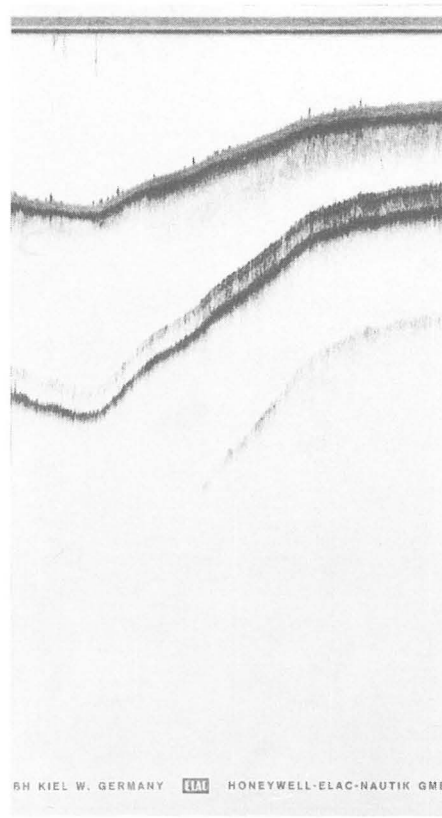
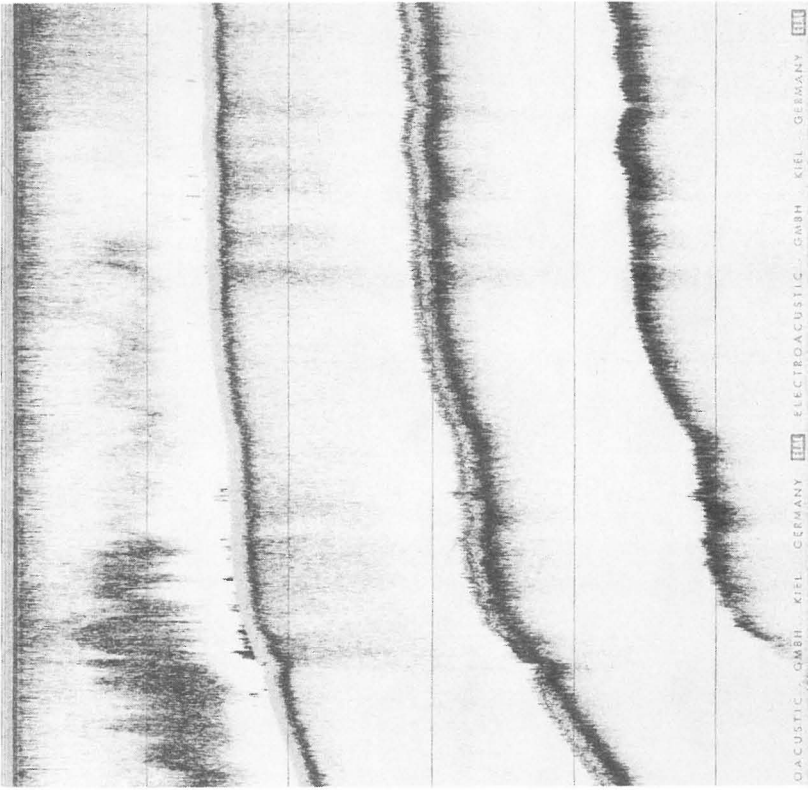

Fig. 2c
Double and triple echo on echogram



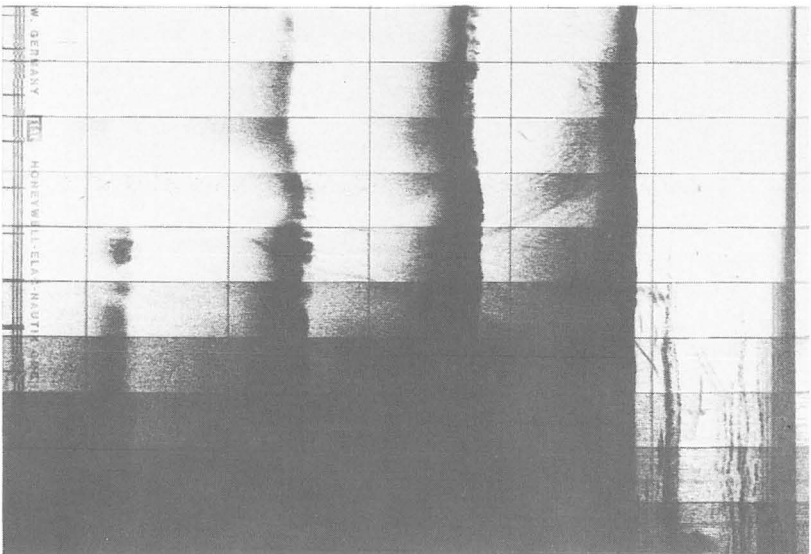

Fig. 3
Multiple echo with varying degrees
of amplification

Fig. 4
Decrease in number of multiple
echoes with increasing depth



Fig. 5 (a, b + c)
Indication of wrecks, rock peaks and fish in echo and double echo

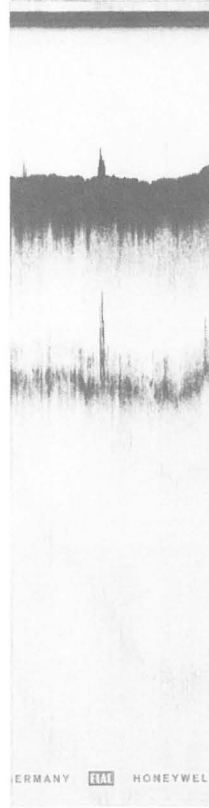

Fig. 6
Indication of bottom layer on echogram

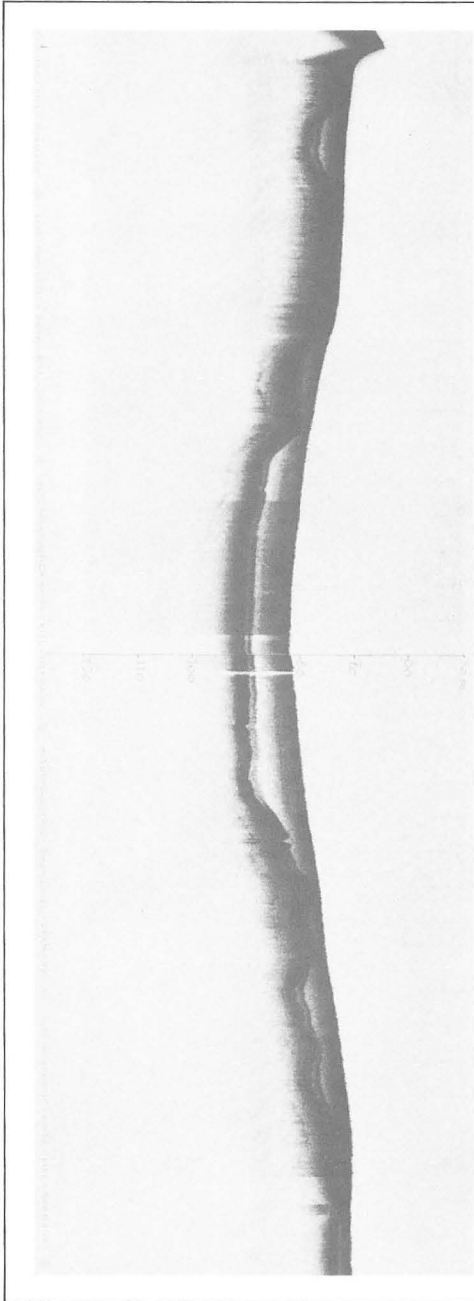

Fig. 7
Echogram taken during a heavy sea

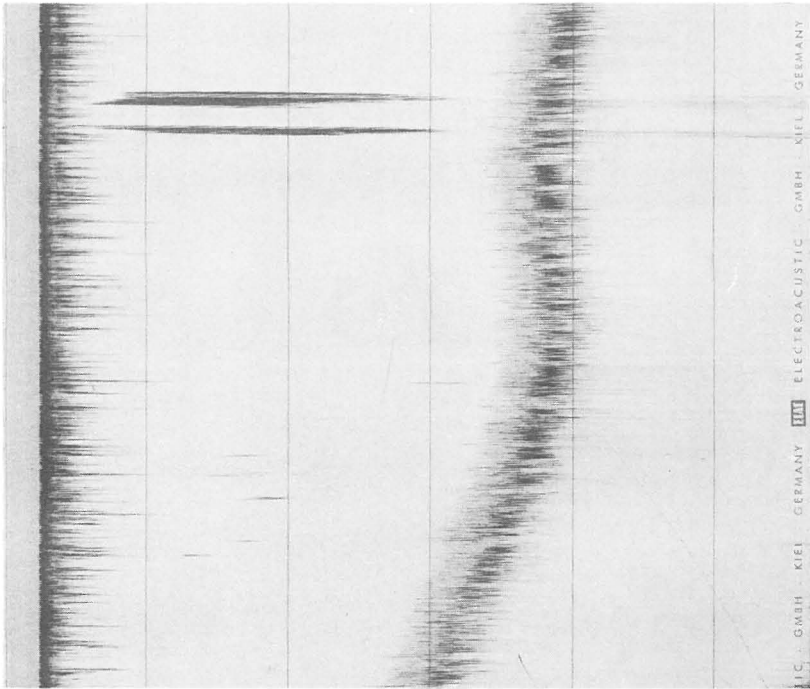

Fig. 8a
Indication of formation of ground at high gain



Fig. 8b
Indication of formation of ground at low gain



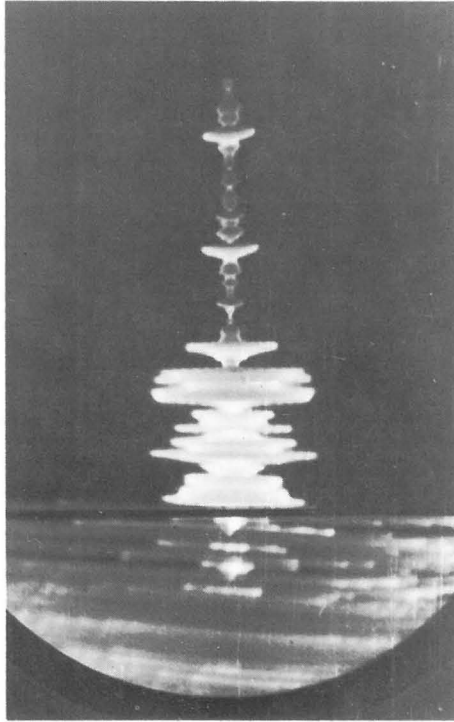
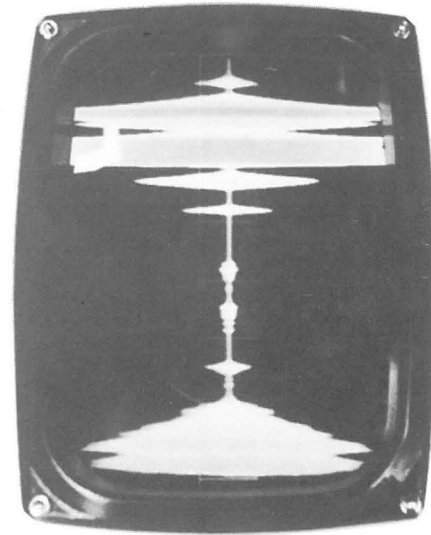

Fig. 9a + b
"Slope indication" on Fischlupe.
"Slope indications" can show the most extreme
shapes. By comparison to fish indications,
these indications show a strong change in
shape from one sounding to another.



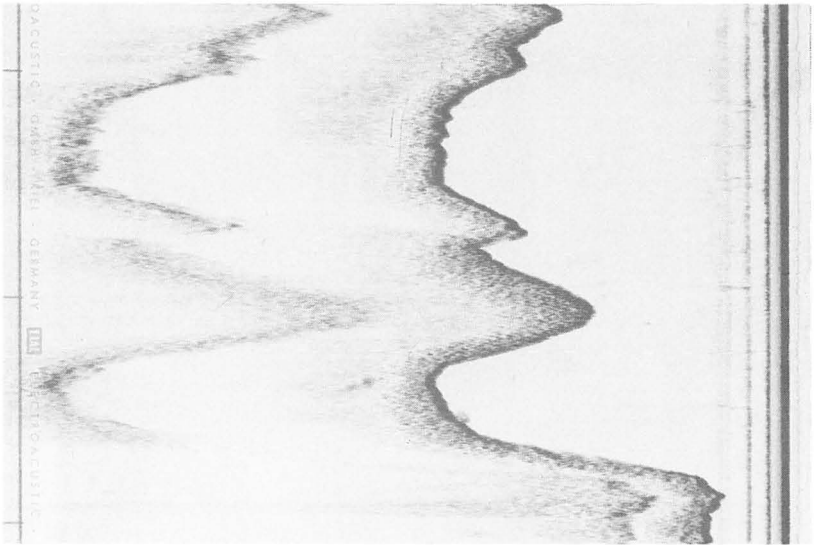

Fig. 9c
"Slope indication" on echogram

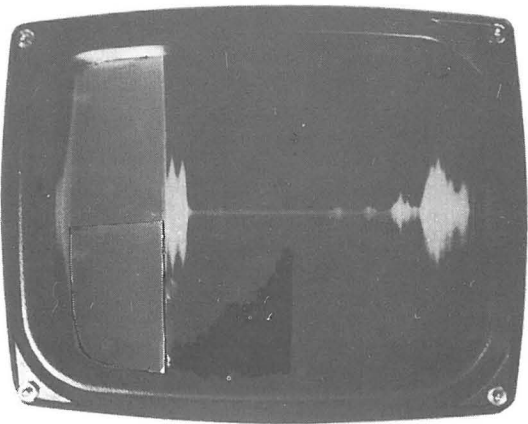

Fig. 10
"Slope indication" on the screen of
Fischlupe

Fig. 11a 1-3
Setting of correct degree of amplification on ELAC-Echometer and ELAC-Echoscope

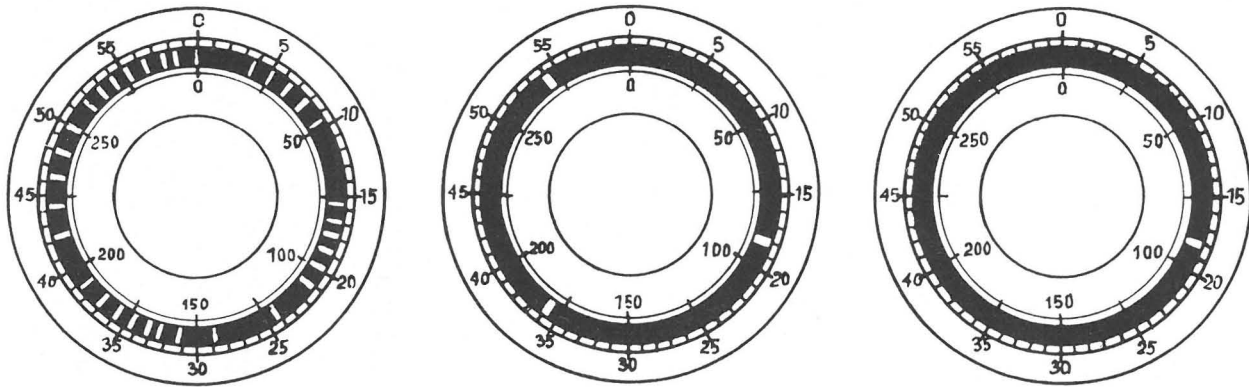

Fig. 11b 1-3
Setting the correct degree of amplification on ELAC-Fischlupe

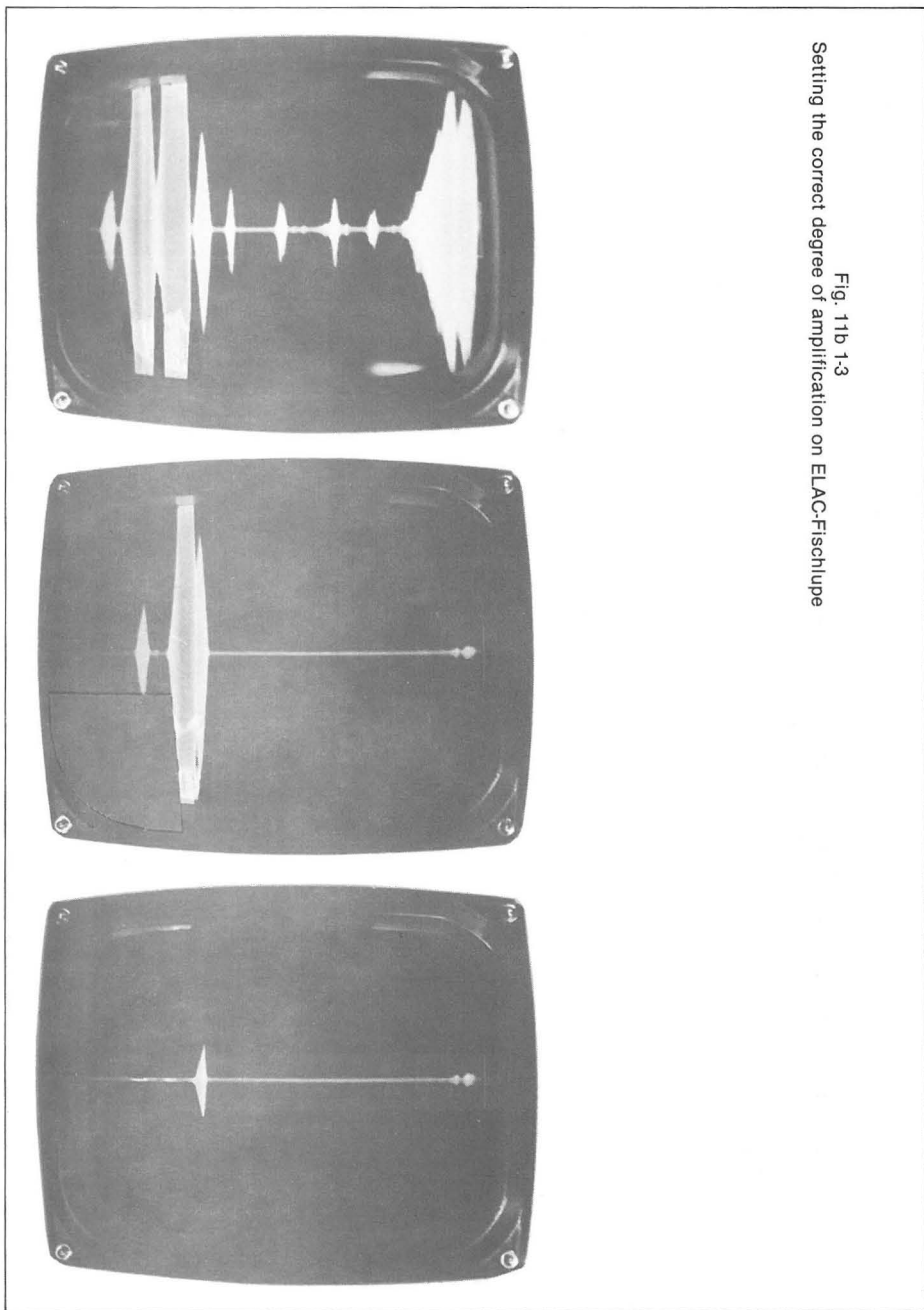

Fig. 12 (a, b + c)
Setting the correct degree of amplification

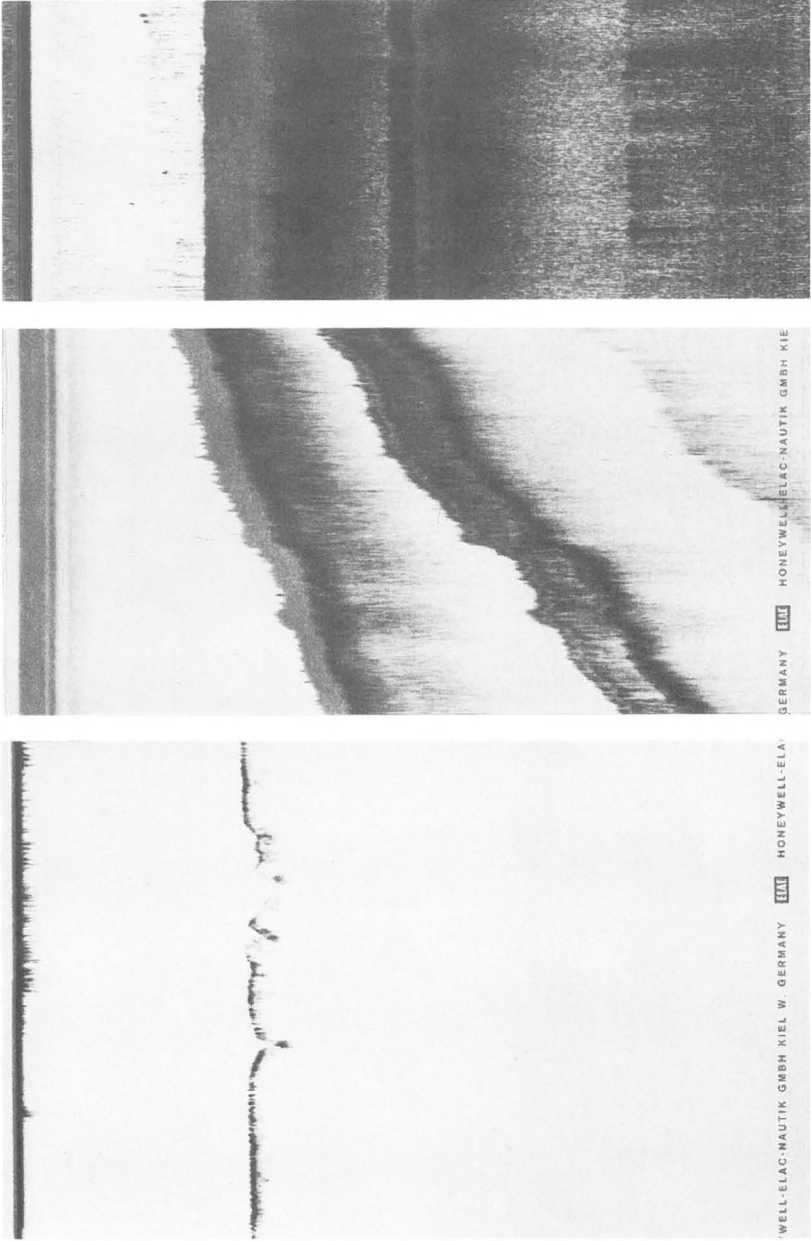

Fig. 13
Interference caused by simultaneous operation of another echosounder

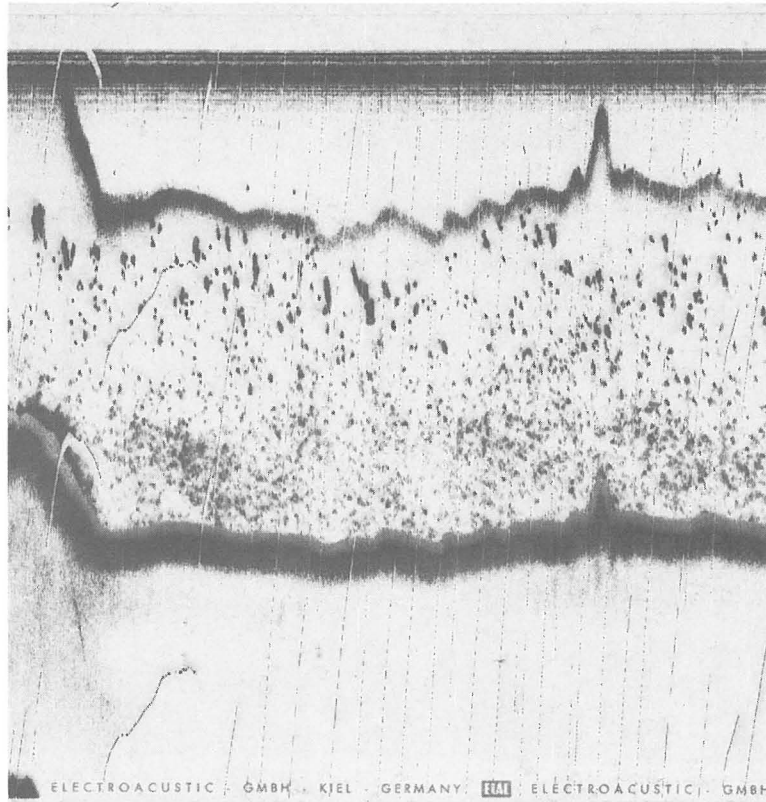

Fig. 14
Indication of single fish on the screen of Fischlupe

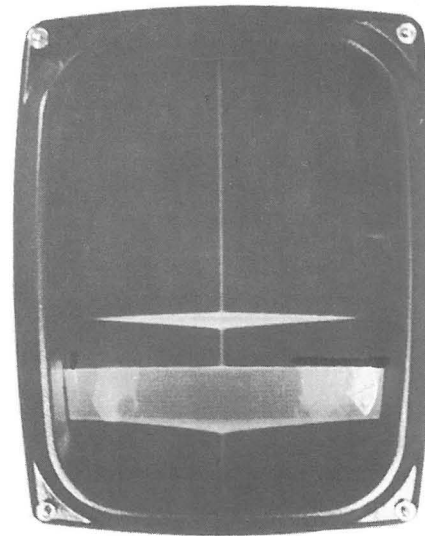
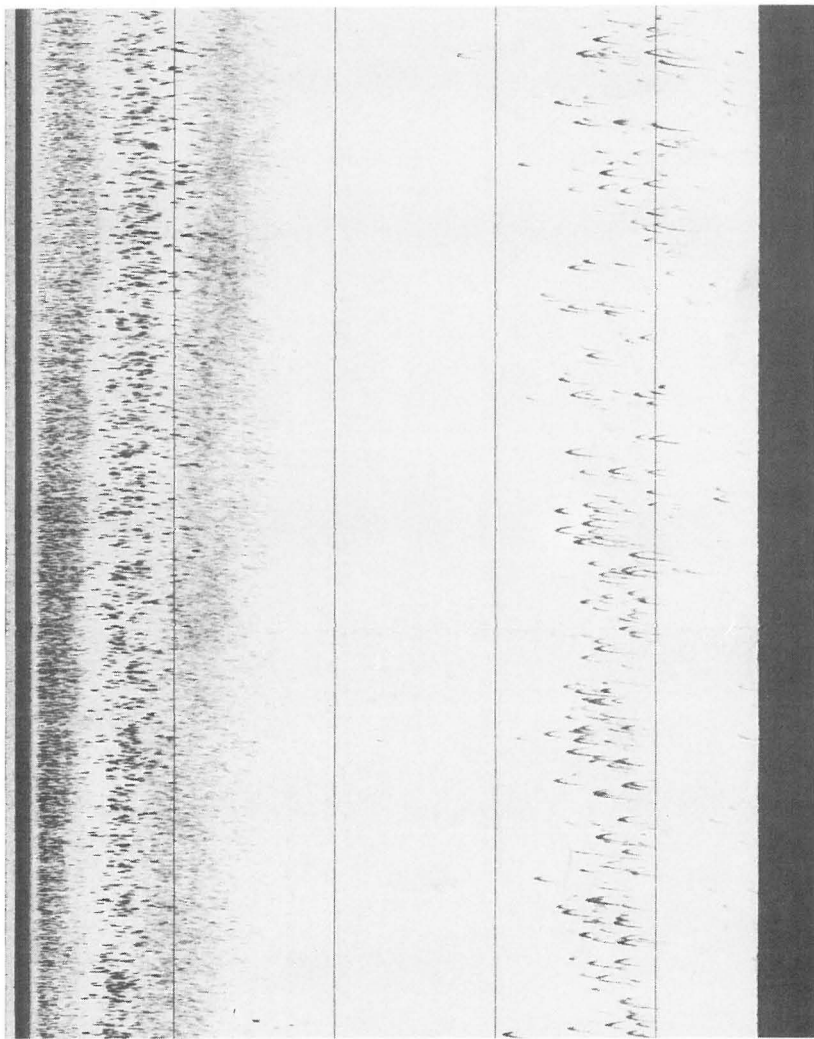

Fig. 15
Indication of single fish on the echogram



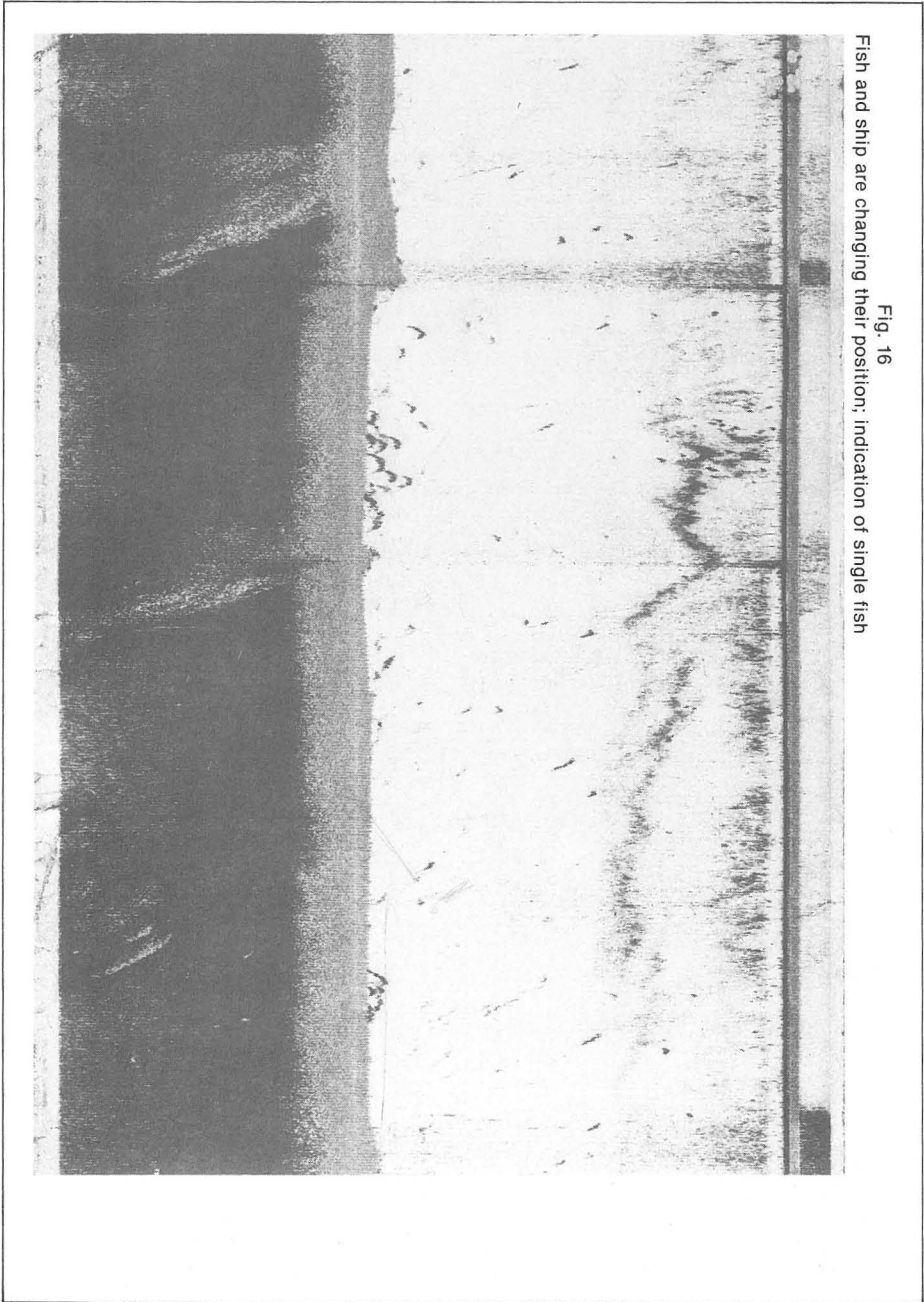

Fig. 16
Fish and ship are changing their position; indication of single fish

Fig. 17
Indication of single fish on the echogram: Thuna

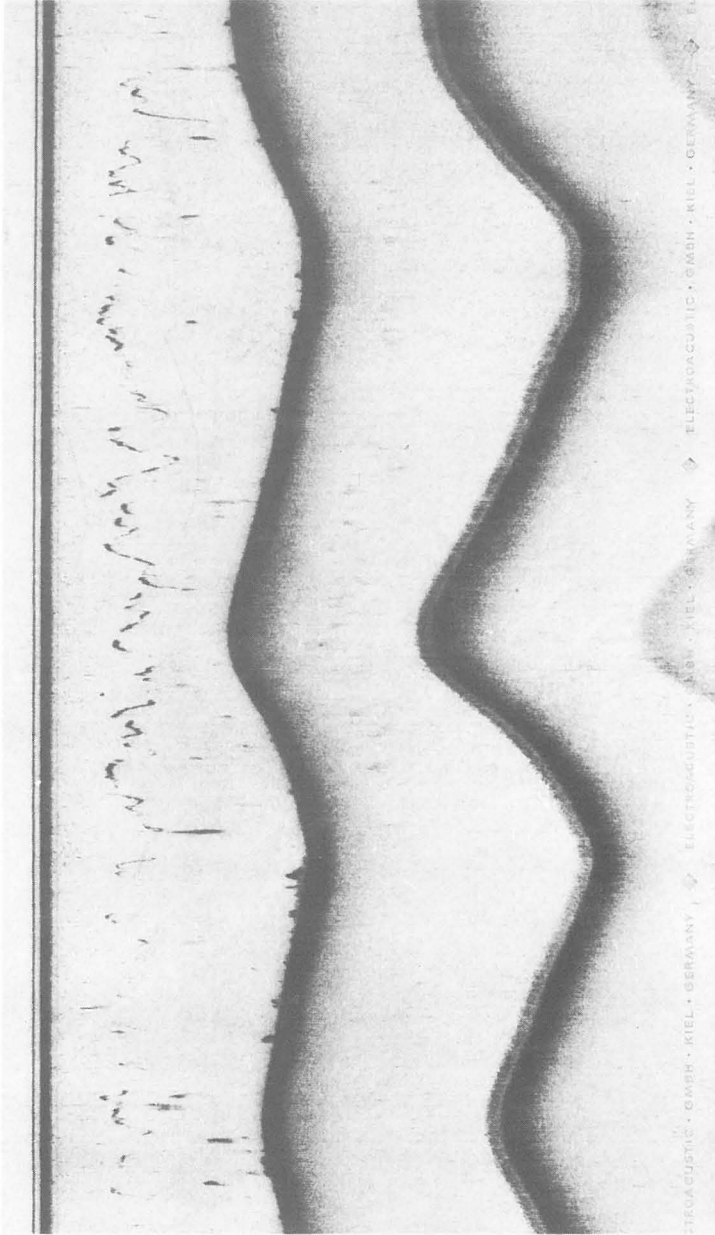

Fig. 18
Indication of shoals of fish on the echogram

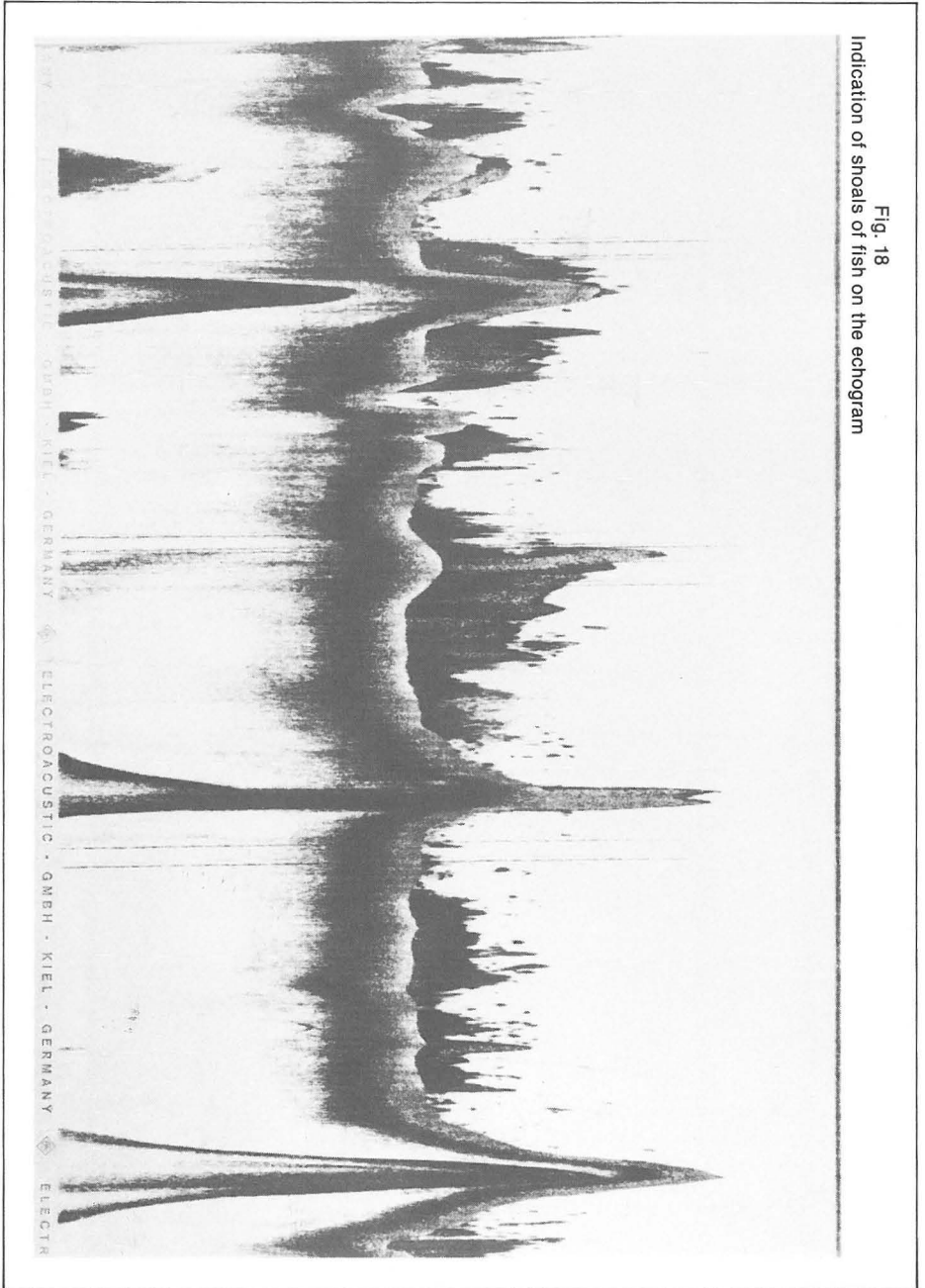

Fig. 19 a
Indication of shoals of herrings, ship not moving

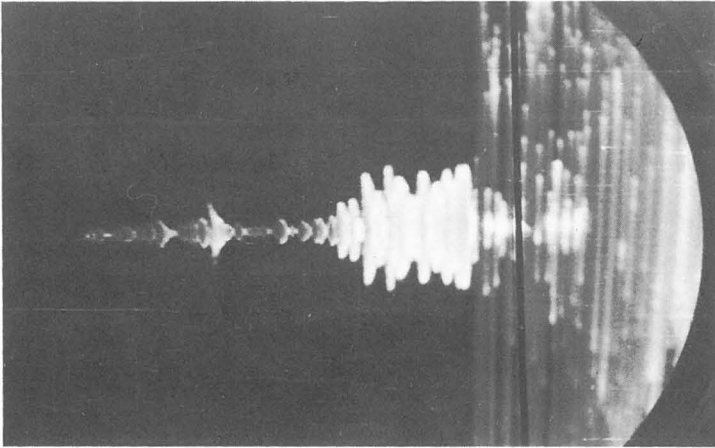

Fig. 19b
Indication of shoals of herrings, ship not moving

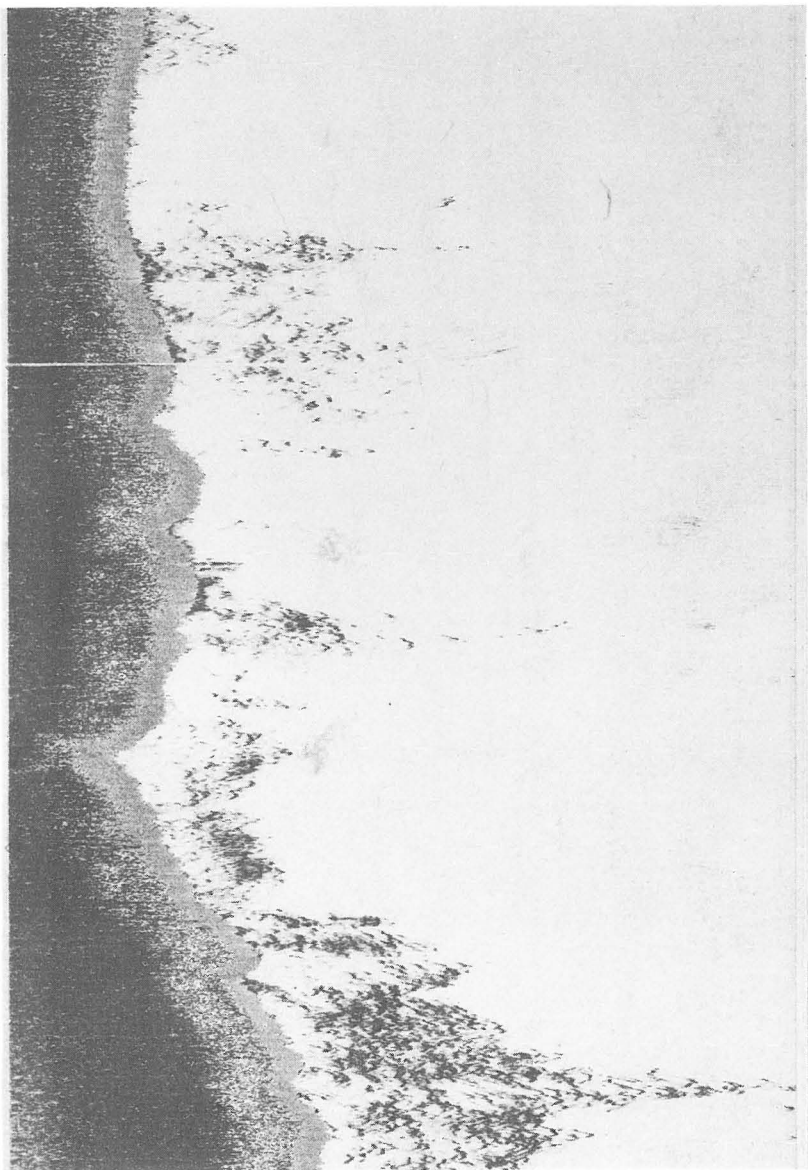
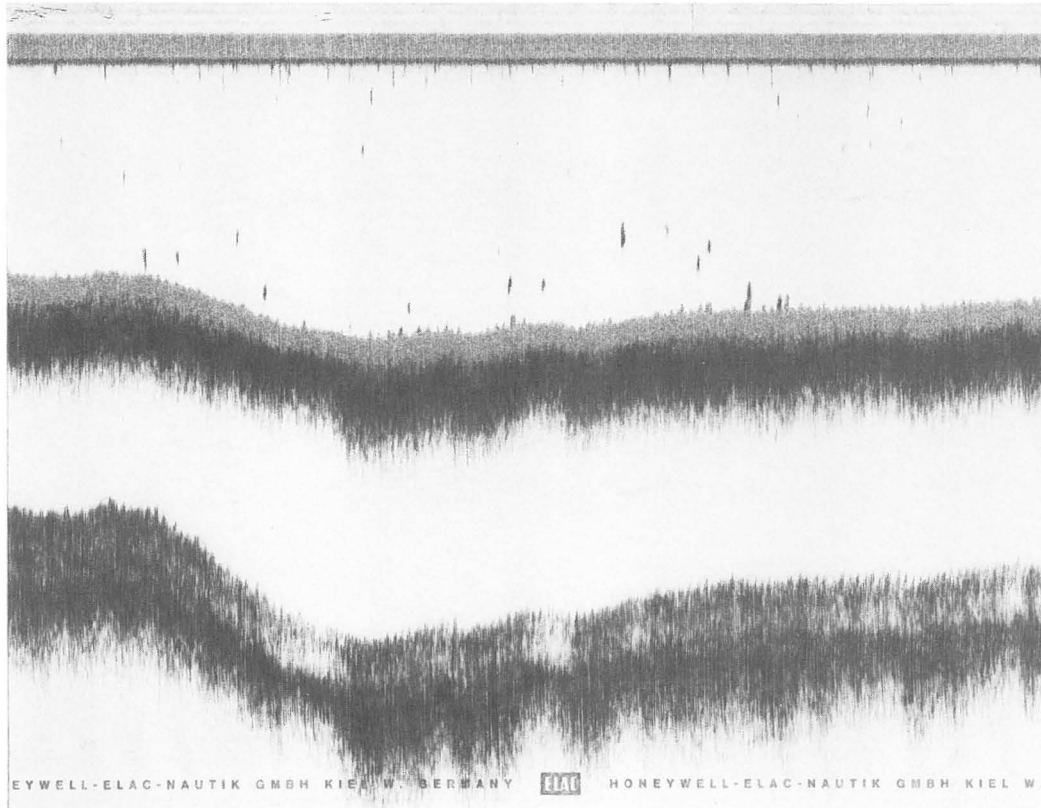

Fig. 20

Indication of bottom fish on echogram and simple recognition because of setting the grey-line



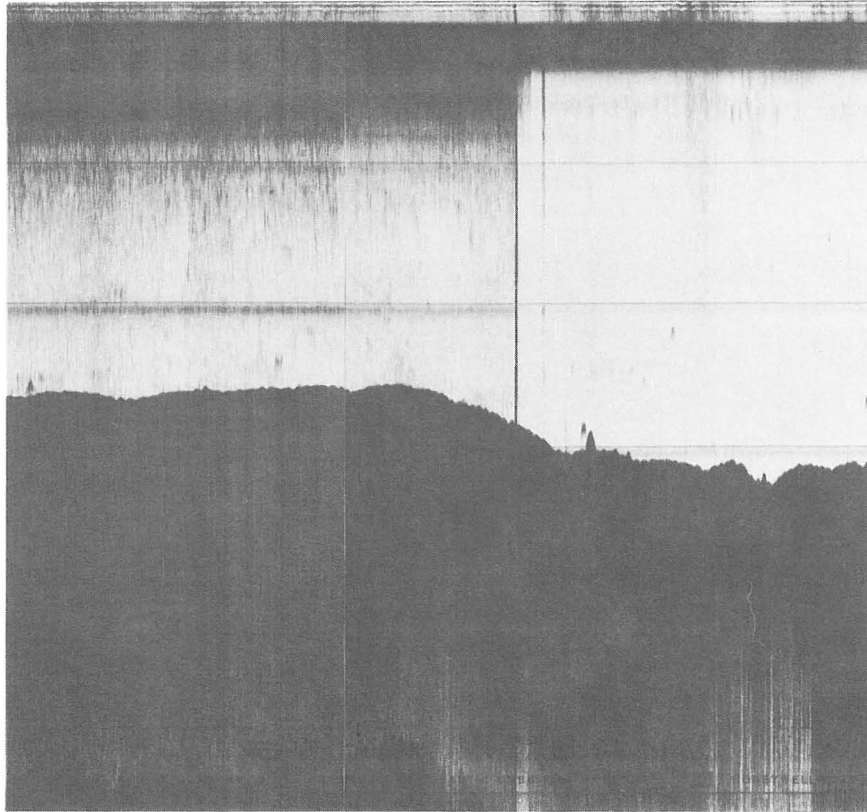
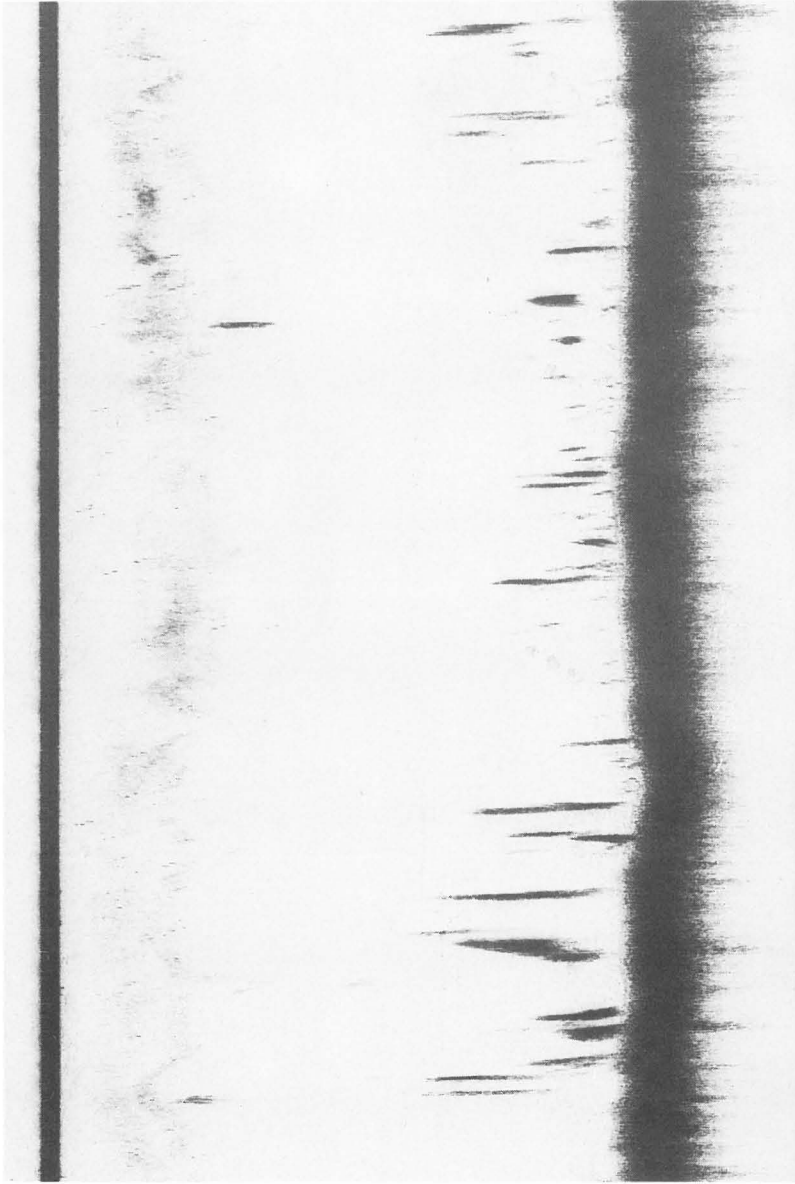

Fig. 21 left
Indication of scattering layer
on echogram

Fig. 21 right
The time sensitivity control in
dependence on the depth of sounding
causes the effect of nearly
constant intensity of indication

Fig. 22
Elimination of undesirable indication of scattering layer through the time sensitivity control in the ELAC-echograph;
only indication of fish in scattering layer



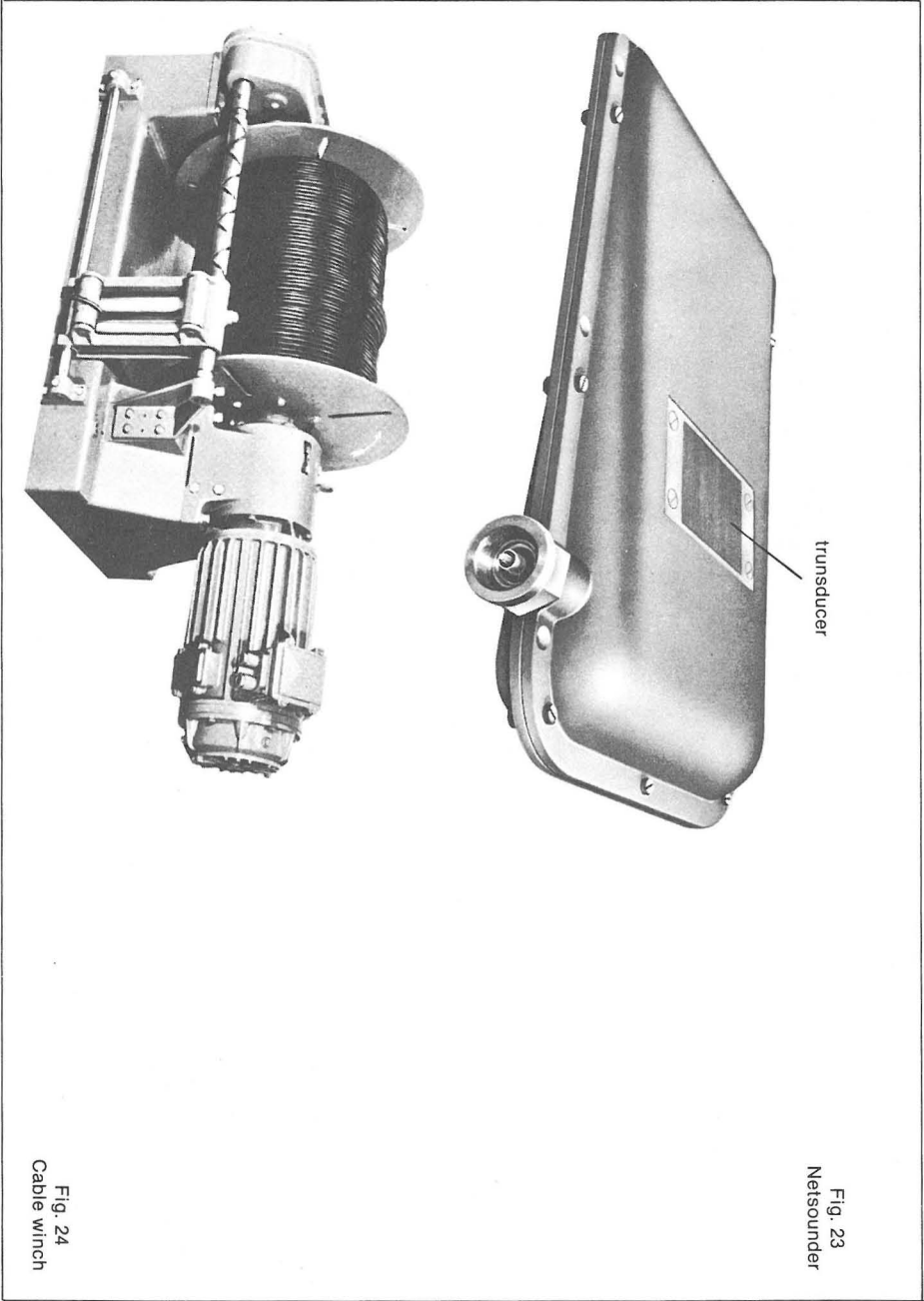

Fig. 24
Cable winch

Fig. 23
Netsounder

Fig. 25
Directed fishing with horizontal (1) and vertical (2) echosounding and netsounder(3)

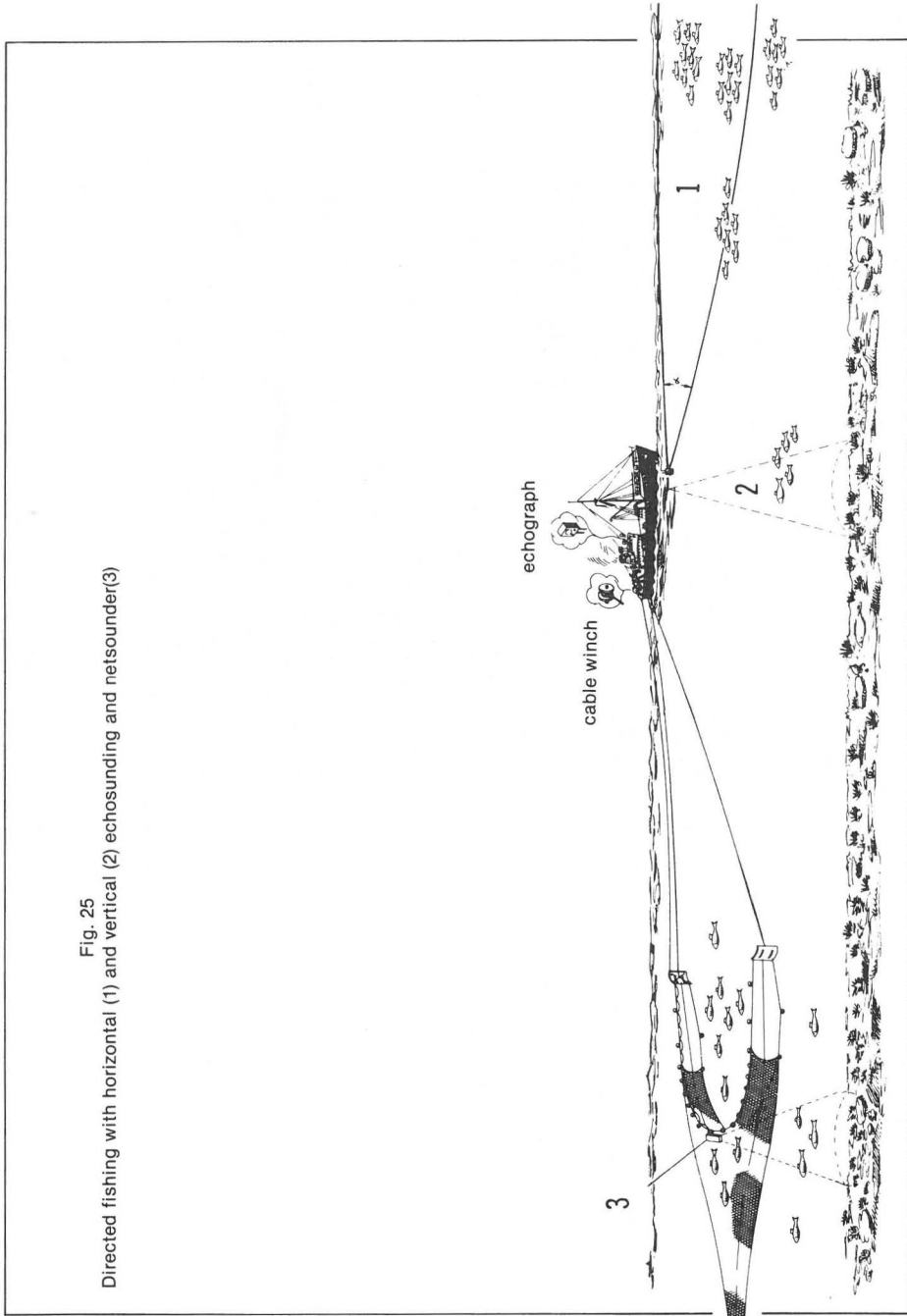
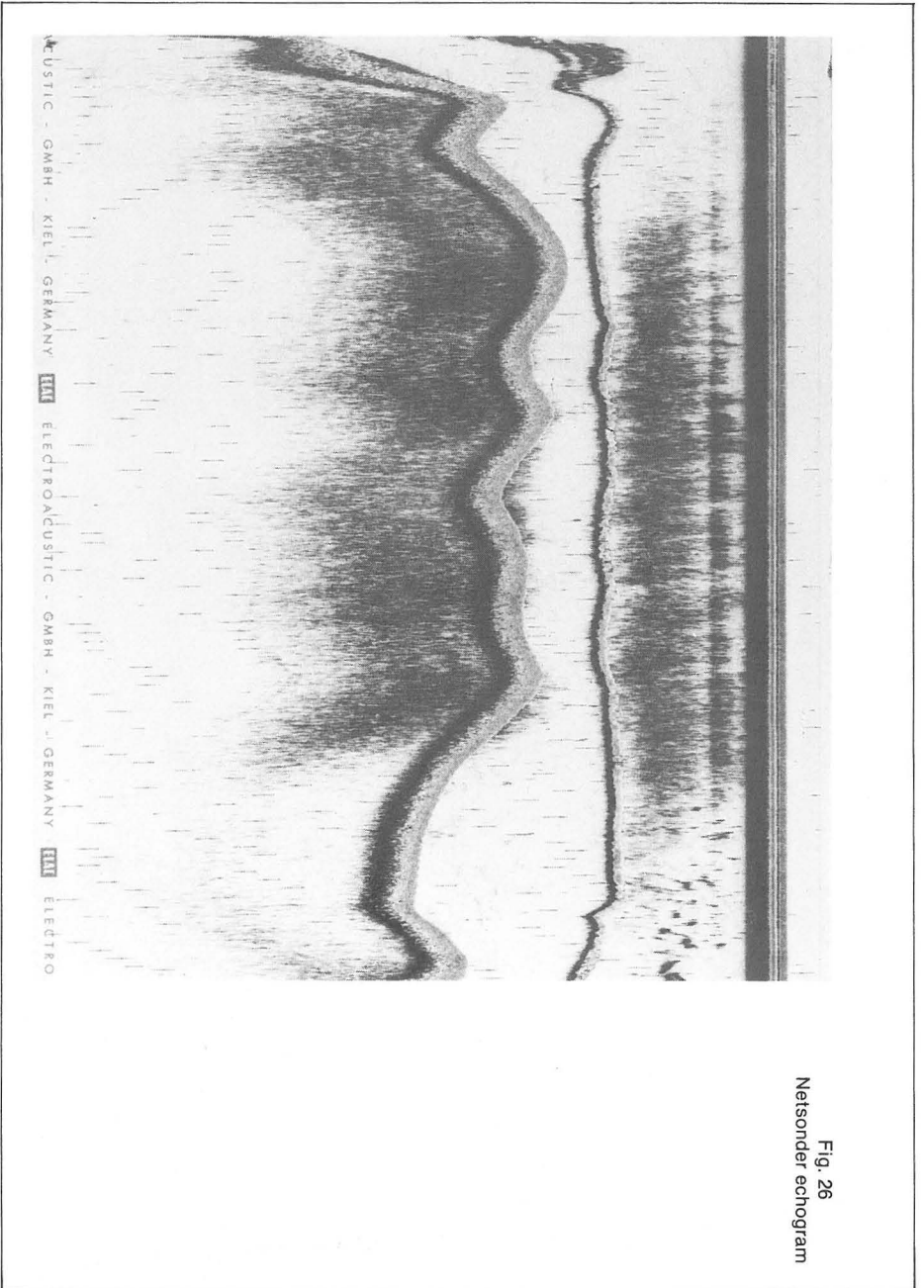

Fig. 26
Netsonder echogram



Published by Honeywell-ELAC-Nautik GmbH
D-2300 Kiel 1, Westring 425-429

Reproduction of this brochure - or portions thereof - with permission of publisher only.

Honeywell ELAC Nautik GmbH

P.O.Box 2520·D-2300 Kiel 1·W.-Germany·Telex 0292521·Phone (0431) 883-0
Printed in W. Germany.

99 171 6048 RK e 4/82