

DFO - Library / MPO - Bibliothèque



12042723

BULLETIN 167
(Second Edition)

A PRACTICAL HANDBOOK OF SEAWATER ANALYSIS

BY J.D.H. STRICKLAND AND T.R. PARSONS

**FISHERIES RESEARCH BOARD OF CANADA
OTTAWA 1972**

Recd May 10/77
Receipt



A PRACTICAL HANDBOOK
OF SEAWATER ANALYSIS

SH
223
B8213
#167
Rev.
C.2

BULLETIN 167 (Second edition)

LIBRARY / BIBLIOTHÈQUE
FISHERIES AND OCEANS / PÊCHERIES ET OCÉANS
OTTAWA, ONTARIO, CANADA
K1A 0E6

A Practical Handbook of Seawater Analysis

By

J. D. H. Strickland and T. R. Parsons

FISHERIES RESEARCH BOARD OF CANADA

Ottawa 1972

I had put Index 1976
then changed it without
consulting
no ISBN added
as requested

UNIVERSITY OF TORONTO
LIBRARY
130 St. George Street
Toronto, Ontario
M5S 1A5

© Minister of Supply and Services Canada 1977

Available by mail from:

Printing and Publishing
Supply and Services Canada
Ottawa, Canada K1A 0S9

or through your bookseller

A deposit copy of this publication is also available
for reference in public libraries across Canada

they to
this

Catalogue No. Fs 94-167

Canada: \$10.00

Other countries: \$12.00

Price subject to change without notice

Ottawa

First Edition published in 1968
Second Edition published in 1972
Reprinted 1975, 1977

Printed by The Alger Press Ltd.
Contract # OKX6-1032

Bulletins are designed to interpret current knowledge in scientific fields pertinent to Canadian fisheries and aquatic environments.

The *Journal of the Fisheries Research Board of Canada* is published in annual volumes of monthly issues and *Miscellaneous Special Publications* are issued periodically. These series are for sale by Supply and Services Canada, Printing and Publishing, Ottawa, K1A 0S9. Remittances must be in advance, payable in Canadian funds to the order of the Receiver General for Canada.

*Editor and Director
of Scientific Information* J. C. STEVENSON, PH.D.

Deputy Editor J. WATSON, PH.D.

Assistant Editors JOHANNA M. REINHART, M.SC.
D. G. COOK, PH.D.

Production-Documentation J. CAMP
MONA I. SMITH, B.H.SC.

Department of Fisheries and the Environment
Fisheries and Marine Service
Scientific Information and Publications Branch
116 Lisgar Street, Ottawa, Canada
K1A 0H3

EDITOR'S FOREWORD

The original publication on this subject appeared under the title of *A Manual of Sea Water Analysis* in 1960 as Bulletin No. 125, Fisheries Research Board of Canada. A second edition was published in 1965 and both editions have been long out of print. The first edition of a completely revised and updated version was published under the title of *A Practical Handbook of Seawater Analysis* in 1968 as Bulletin No. 167, and went out of print in 1971.

This is the second edition of the latter work. It contains revised methods for determination of Ammonia Plus Amino Acids and of Ammonia, and one new method not in the first edition, "Determination of Urea". Minor corrections and alterations have been made throughout the text. These changes will add to the value of this text as an authoritative reference book on seawater analysis.

The senior author, Dr J. D. H. Strickland passed away in California on November 12, 1970. The second author, Dr T. R. Parsons, introduced the changes in this edition and wishes to thank Messrs F. A. J. Armstrong and K. Stephens and Miss Lucia Solorzano for their assistance. Dr Parsons, formerly with the Fisheries Research Board of Canada Biological Station at Nanaimo, B.C., is now with the Institute of Oceanography, University of British Columbia, Vancouver, B.C.

J. CAMERON STEVENSON

Ottawa 1972

Contents

PREFACE, 1

ACKNOWLEDGMENTS, 3

NOTE ON STATISTICAL LIMITS, 5

NOTES ON APPARATUS, 7

PART I. SALINITY, DISSOLVED OXYGEN, CARBONATE AND SULPHIDE, 11

I.1. Determination of salinity by titration (high precision), 11

I.2. Determination of salinity by titration (low precision), 17

I.3. Determination of dissolved oxygen, 21

I.4. Determination of carbonate, bicarbonate, and free carbon dioxide from pH and alkalinity measurements, 27

I.4.I./ Determination of experimental quantities, 29

I.4.II. Calculation and use of tables, 33

I.5. Direct determination of total carbon dioxide, 35

I.6. Determination of sulphide, 41

PART II. INORGANIC MICRONUTRIENTS IN SEA WATER, 45

II.1. Introductory remarks on a differentiation of the various forms of phosphorus, 45

II.2. Determination of phosphorus, 49

II.2.I. Determination of reactive phosphorus, 49

II.2.II. Determination of reactive phosphorus (low levels), 53

II.3. Determination of total phosphorus, 57

II.4. Determination of inorganic polyphosphate, 63

II.5. Determination of reactive silicate, 65

II.6. Determination of reactive nitrate, 71

II.7. Determination of reactive nitrite, 77

II.8. Determination of ammonia plus amino acids, 81

II.9. Determination of ammonia, 87

II.10. Determination of urea, 91

II.11. Determination of hydroxylamine, 95

II.12. Determination of reactive iron, 99

II.12.I. Determination of particulate iron, 101

II.12.II. Determination of soluble iron, 107

II.13. Determination of manganese, 111

II.14. Determination of copper, 117

II.15. Automated nutrient analysis, 121

II.15.I. Description of apparatus, 121

II.15.II. Nutrient analysis, 127

II.15.II.1. Nitrate, 127

II.15.II.2. Nitrite, 131

Contents — Continued

- II.15.II.3. Ammonia method for the autoanalyzer, 133
- II.15.II.4. Phosphate, 135
- II.15.II.5. Silicate, 137

PART III. DETERMINATION OF SOLUBLE ORGANIC MATTER, 139

- III.1. Determination of monophosphate esters, 139
- III.2. Determination of soluble organic phosphorus by ultraviolet light oxidation, 141
- III.3. Determination of soluble organic nitrogen, 143
 - III.3.I. Kjeldahl digestion, 143
 - III.3.II. Ultraviolet light oxidation, 149
- III.4. Determination of soluble organic carbon, 153
- III.5. Determination of cyanocobalamine (vitamin B₁₂), 159
- III.6. Determination of biotin, 165
- III.7. Determination of thiamine (vitamin B₁), 169
- III.8. Determination of carbohydrate, 173

PART IV. DETERMINATION OF PARTICULATE MATERIALS, 175

- IV.1. Introductory remarks on different methods for determining particulate materials in aquatic environments, 175
- IV.2. A separation of microscopic particles from sea water, 177
 - IV.2.I. Determination of the weight of microscopic materials in sea water, 181
- IV.3. Pigment analysis, 185
 - IV.3.I. Spectrophotometric determination of chlorophylls and total carotenoids, 185
 - Addendum* to IV.3.I. Spectrophotometric determination of phaeo-pigments, 193
 - IV.3.II. SCOR/UNESCO procedure for chlorophylls, 195
 - IV.3.III. Determination of chlorophyll *c*, 197
 - IV.3.IV. Fluorometric determination of chlorophylls, 201
 - Addendum* to IV.3.IV. Fluorometric determination of phaeo-pigments, 203
 - IV.3.V. Automated estimation of chlorophyll pigments by fluorescence, 205
- IV.4. Determination of particulate carbon, 207
 - IV.4.I. Wet oxidation with dichromate, 207
 - IV.4.II. Combustion in oxygen (high levels), 213
 - IV.4.III. Combustion in oxygen (low levels), 215
- IV.5. Determination of particulate phosphorus, 219
- IV.6. Determination of particulate nitrogen, 221
 - IV.6.I. Combustion method (high levels), 221
 - IV.6.II. Kjeldahl method with ninhydrin finish (low levels), 223
- IV.7. Determination of particulate lipid, 227

Contents — Concluded

- IV.8. Determination of particulate carbohydrate, 231
 - Addendum* to IV.8. Determination of "crude fiber," 235
- IV.9. Determination of chitin, 237
- IV.10. Determination of desoxyribose (DNA), 241
- IV.11. Determination of adenosine triphosphate (ATP), 245
- IV.12. Electronic sizing and counting of particles, 251
 - IV.12.I. Description of apparatus, 251
 - IV.12.II. Calibration, 252
 - IV.12.III. Preparation of sample, 254
 - IV.12.III.1. Suspended materials, 254
 - IV.12.III.2. Sedimented materials, 254
 - IV.12.IV. Particle spectra, 255
 - IV.12.IV.1. Arithmetic distributions, 256
 - IV.12.IV.2. Logarithmic distributions, 256
- IV.13. Automated determination of relative turbidity with a fluorometer, 259
- PART V. PHOTOSYNTHETIC RATE MEASUREMENTS, 261
 - V.1. Introductory remarks, 261
 - V.2. Changes of dissolved oxygen, 263
 - V.3. Uptake of radioactive carbon, 267
 - V.4. Growth rate of suspended material, 279
- PART VI. TABLES AND SPECIAL DIAGRAMS, 283
 - VI.1. Temperature correction for chlorosity determination, 283
 - VI.2. Conversion of chlorosity to salinity, 284
 - VI.3. Temperature corrections for *pH* measurements, 294
 - VI.4. Pressure corrections for *pH* measurements, 295
 - VI.5. Conversion of *pH* to hydrogen ion activity, 296
 - VI.6. Factors for total alkalinity measurement, 297
 - VI.7. Total alkalinity calculation, 297
 - VI.8. Conversion of total alkalinity to carbonate alkalinity, 298
 - VI.9. Conversion of carbonate alkalinity to total carbon dioxide, 300
 - VI.10. Conversion of carbonate alkalinity to partial pressure of carbon dioxide, 301
 - VI.11. Solubility of carbon dioxide in sea water, 302
 - VI.12. Quasi-thermodynamic second dissociation constant of carbonic acid in sea water, 303
 - VI.13. Total carbon dioxide by gas analysis, 304
 - VI.14. Oxygen solubility nomograph, 305
 - VI.15. Phytoplankton pigment nomographs, 306
 - VI.16. A grade scale based on 1- μ particle diameter, 309
 - VI.17. Coincidence correction chart for different sized apertures, 310

PREFACE

The basic purpose of the book is unchanged. It is not designed as a compendium of methods of seawater analysis but consists of full working instructions of certain procedures used by the authors and their colleagues in the laboratory and at sea and found by them to be reliable and to have an adequate sensitivity and precision for most studies of marine ecology.

The reason for using one approach in favor of another is not always stated, as often it was a matter of judgment and preference on the part of the authors.

Some of the methods are taken directly from the literature with only the slight modifications of solution volumes and concentrations necessary for convenient ship-board use. In many instances, however, the original procedures have been greatly modified where this has been found to result in an increase of speed, precision, or operational simplicity. A number of the methods constitute a completely new application of analytical techniques to marine chemistry.

Although a measurement of the photosynthetic potential of a sample of sea water or of the growth rate of suspended matter is not strictly seawater analysis, these determinations are becoming increasingly important in many marine laboratories and we have taken the opportunity to include a short section on some of the basic procedures involved.

Most of the methods described in this book are for substances that affect or measure organic production in the sea and, in most cases, the methods can be mastered by relatively inexperienced workers in a ship's laboratory. In general the procedures require only simple apparatus but we have included in this new book some approaches which necessitate the use of more highly specialized equipment. This book does not, however, attempt to treat comprehensively the analysis for transitional and "rare" metallic elements, which are mainly of geochemical interest, although we have retained methods for iron, manganese, and copper unchanged from earlier issues. These methods are simple and reliable but more sensitive ones can now be found in the literature.

Automation in seawater analysis is at last a reality but methods and equipment are still in the exploratory stages. We have now accumulated more than 2 years of sea-going experience with automation so that a brief outline of the methodology used by us may prove to be a worthwhile introduction to the subject.

Although the presence of 3.5% dissolved salts in the ocean gives rise to many analytical difficulties, the relative constancy of composition and ionic environment of sea water has the advantage that one method will generally be applicable to sea waters of all normal salinities. The methods given here are designed solely for sea water and should be used with caution if applied to the analysis of lake water, brackish waters, or water heavily contaminated with organic and inorganic pollutants such as the interstitial water in sediments. In many of these instances major modifications will be necessary. For work in anoxic basins, where hydrogen sulphide is present, most of the methods given here may be used provided that the hydrogen

sulphide is first removed by acidifying the solutions to about *pH* 3 and bubbling vigorously with nitrogen gas until no more sulphide smell is apparent. Generally, quantities of certain substances such as ammonia and phosphate will be considerably higher in anoxic waters than in ordinary sea water.

As mentioned in the Preface to our earlier works, we cannot claim that all the present methods are as free from defects as might be desirable, or that better techniques may not exist or become available soon. However, it is hoped they may prove of use to newcomers in the field or to institutions where marine chemistry is not of major importance but where a certain amount of analysis may have to be undertaken.

ACKNOWLEDGMENTS

The source of each method is given at the commencement of each description. So many colleagues and assistants have helped us test and modify methodology in the past 10 years that it is becoming difficult to name them all but we wish especially to express our gratitude to F.A.J. Armstrong, K.H. Austin, A.F. Carlucci, R.W. Eppley, O. Holm-Hansen, C.D. McAllister, R.W. Sheldon, Srta Lucia Solorzano, K.V. Stephens, J.P. Tully, and P.M. Williams. The editorial staff of the Fisheries Research Board of Canada have been of great assistance.

Thanks are due to Dr G. L. Pickard, Director of the Institute of Oceanography at the University of British Columbia, for permission to include his tables for the conversion of 20 C chlorosity to salinity. The tables given for calculating the carbonate balance of sea water largely follow the Buch presentation as given by H. W. Harvey in his book: *The Chemistry and Fertility of Sea Waters* (Cambridge University Press, 1957). They have been extended and some have been changed so as to incorporate a more recent estimate of the second carbonic acid dissociation constant by J. Lyman.



NOTE ON STATISTICAL LIMITS

The systematic errors in a method, which are often difficult to determine or eliminate, govern what we prefer to term the *accuracy* of a determination. The accuracy of the analyses described here is, to the best of our knowledge, complete and no avoidable systematic errors should occur, although it would be unwise to dogmatize on this point.

However, each method will certainly give rise to more or less random errors which govern what we prefer to term its *precision*. If these random errors obey a Gaussian distribution they are characterized by a standard deviation, σ , which can be estimated by performing a sufficiently large number of replicate determinations. The range on each side of any one experimental result in which the *true result* may lie will depend upon the σ value for the determination concerned and the degree of probability with which we are satisfied. In most industrial measurements the 95% confidence limit, which is approximately $\pm 2\sigma$, is considered adequate and 2σ (not σ) has been used to express the precision of the methods described in this manual.

The precision, P , quoted for each method is such that, if n determinations are made, the true result will lie in the range:

Mean of n determinations $\pm P/n^{1/2}$ with a 95% confidence (19:1 odds).

The values for P quoted here have been determined on homogeneous samples of water and thus apply to the method as such, and do not include random errors such as from over-side sampling, about which it is next to impossible to make generalizations.

The values for P have also been determined under as realistic conditions as possible (on board ship if feasible) by workers familiar with the methods. As P often varies with the magnitude of the property being measured it is quoted for two levels of concentration or for the concentration level most likely to be encountered.

The limit of detection of a method is governed by its precision, being the level at which the amount present is just significantly different from a "blank" determination. For safety (to allow for skewness of error distribution) the limit of detection should be taken as at least 3σ , where σ is measured for amounts near to the detection limit itself. This rule has been observed in the following methods, although the best value for σ has sometimes been only a guess.

It should be noted that no great accuracy is claimed for the value of P itself. The variance of a method must depend a lot on the conditions under which the method is carried out and on the skill of the operator. Ideally σ should be determined using many more replicate determinations than we have managed to make, having first shown that errors lie on a normal distribution curve. However, the approximate limits quoted in the following methods are thought to be a reasonable estimate of the precision to be expected in normal circumstances and are thus a useful guide and give the analyst some appreciation of the likely significance of his results.



NOTES ON APPARATUS

Experience indicates that any delicate weighing operation or highly precise titration work (such as is necessary for the best salinity determinations) is unsuited to routine shipboard use. It is also very inconvenient to undertake the evaporation and "fuming" of solutions in most ship laboratories. The methods in this manual have been designed with these considerations in mind and, whenever possible, substances are determined by light absorptiometry.

Each method will be found to have a section entitled "Special Apparatus and Equipment." Under this heading we have listed all apparatus and equipment which is not in common use in most chemical laboratories. However, certain pieces of equipment that are frequently specified will be discussed now rather than in the body of the text.

ABSORPTIOMETRY

The best type of absorptiometer to use is a matter of choice and availability. We have found that a spectrophotometer, such as the Beckman DU spectrophotometer, is a very satisfactory shipboard instrument, even in quite rough weather, and has obvious advantages over simpler absorptiometers. All methods involving a colorimetric determination are written, therefore, assuming the use of a Beckman DU instrument with a suitable slit width and photocell. The best wavelength of light and the necessary cuvette length are always stated and this information will enable the analyst to judge the best conditions for any other instrument. If a simple absorptiometer using a broad-band filter must be employed, the sensitivity of any method will be reduced (by as much as a half in some instances).

Throughout this manual the term extinction (symbol E) is employed. The extinction is defined as $\log I_0/I$ where I_0 and I are incident and transmitted light intensities, respectively. Spectrophotometers are calibrated directly in extinction units (also called optical density or absorbency). If the absorptiometer employed reads percentage transmission, T , calculate E as $\log_{10}(100/T)$. The use of transmission values in absorptiometry is to be discouraged as they are rarely if ever simply related to the concentration of substance being measured.

FLUOROMETRY

Although many makes of fluorometer can be used the Model III Fluorometer, made by G.K. Turner Associates, 2524 Pulgas Avenue, Palo Alto, California, has proven to be very suitable for sea-going work and is strongly recommended. A high-sensitivity door should be used with the Turner fluorometer. Readings are obtained in arbitrary units of 0-100 with each of the four "door" openings. These openings let in differing amounts of light to illuminate fluorescing solutions. The concentration of fluorescing matter in solution is proportional to the product of the reading and a factor depending on the door being used. The values for this factor for each door must be determined experimentally in each method as the relationships between door factors given by the manufacturers cannot be accepted without confirmation.

AUTOMATIC PIPETTES

For reagent volumes ranging between 0.5 and 5 ml, automatic pipettes are useful and are stipulated in most of the methods. We have found a simple rubber-bulb type (e.g. that made by Frederick G. Keys Ltd.) quite satisfactory provided that reagent volumes are not critical to more than about $\pm 5\%$, but this type of pipette is not recommended when the addition of a solution governs the final volume used in an absorptiometer.

CENTRIFUGATION

It is assumed in Part IV that a centrifuge holding 15-ml graduated tapered centrifuge tubes is available. A medium-to-high speed instrument is required and we recommend a centrifuge in which the tubes spin out horizontally, rather than an "angle head" type of instrument. Although glass-stoppered glass tubes are specified these may crack on continual use and polyethylene- or teflon-stoppered glass tubes may be preferable during centrifugation.

FILTRATION

Filtration is used either to separate particulate matter in sea water for analysis or to obtain a particle-free sample of water for the analysis of "soluble" material. Several types of filter have been recommended for marine work and continuous centrifugation at high speed can be surprisingly effective although it is generally inconvenient to manipulate. To replace paper filters, organic membrane filters and glass-fiber or silver-fiber filter papers are commonly employed. Vacuum may be controlled by one of the devices mentioned on p. 182.

There is evidence that the borderline between "particulate" and "dissolved" organic matter in sea water is arbitrary and depends on the pore-size and adsorptive properties of the filter used. An ideal filter cannot be specified but the exact filter used should always be stated when reporting analytical data. We generally recommend the use of two sizes, 25- and 47-mm diam discs made either of organic membrane or of glass. The membrane filters obtainable from the Millipore Filtration Corporation of Watertown 72, Massachusetts, USA, are in common use, although equivalent filters from other manufacturers are, to the best of our knowledge, equally acceptable. Similarly we recommend the use of Whatman Glass Filters GF/C grade without suggesting that suitable alternatives may not be available. For preparing particle-free water, Millipore HA filters (with a pore-size of about 0.5μ) are generally considered adequate but the increase in "dissolved" matter in the filtrate is probably marginal if GF/C papers with a mean pore-size of $2-3 \mu$ are used. If organic membranes are used to prepare water for analysis they must first be washed by passing at least 300 ml of distilled water through them and rejecting the filtrate. Special Pyrex filter holders and clamps are provided by the Millipore Filtration Corporation for use with both their 47- and 25-mm diam discs. This equipment, or equivalent, is used and it is recommended that Buchner flasks of at least 2-liter capacity act as reservoirs. A moderate source of vacuum is required such as that given by a water aspirator pump. Generally suction should not exceed 200–250 mm of mercury and it is best to have a vacuum indicator in the suction train. Vacuum may be controlled by one of the devices mentioned on p. 182. When filters clog they should be renewed. Nothing is to be gained by further prolonging the filtration.

ULTRAVIOLET LAMPS FOR "COMBUSTION"

Several methods require that seawater samples be irradiated with UV radiation prior to analysis. Radiation of a wavelength less than 2500 Å is required and for this purpose we specify the use of the 1,200-w mercury-arc tube manufactured by Englehard Hanovia Inc. of Newark, New Jersey, and the associated ballast recommended by the manufacturer. It is convenient to mount the lamp axially in a vertical metal cylinder 50 cm in length and 20 cm in diameter. An air-extractor fan should be fixed at the base of the metal cylinder to provide cooling but, as the lamp can be dimmed by excessive cooling, it should be encased in a clear quartz jacket, 4.5 cm in diameter, from which some of the heat can be carried off by a gentle stream of filtered air introduced by a silica tube reaching to the bottom of the jacket. The methods described in this book call for samples to be held in stoppered fused silica tubes, which are 35 cm in length, 2.5 cm in diameter, and about 110 ml in capacity. Twelve of these can be set within the above metal cylinder, 7 cm from the lamp, by resting them on a wire gauze base. The temperature of samples should stabilize at 60–80 C at the top of the tubes after prolonged irradiation.

THERMOSTATICALLY CONTROLLED WATER BATHS

Some degree of temperature control is necessary in most of the methods. Wherever possible we have standardized the temperature at 23 C and even if strict temperature control is unnecessary it is best to warm samples from sea temperature to about 18–25 C before commencing on analysis. We have found a metal "serological" bath, with suitable internal metal partitions, excellent for ship laboratories. The use of such a bath is implied whenever temperature control is stipulated.

HEATERS

Heating liquids on an open plate or water bath is very inconvenient in a ship's laboratory. Several methods in Part IV call for prolonged heating at 100 C. An electrically heated sand bath can be used but we recommend an electrically heated metal block with holes drilled for the various containers. Such blocks are easily constructed, or a suitable piece of equipment (with some modification) can be purchased directly from Hallikainen Instruments, Berkeley, California, USA.

DEEP-FREEZER STORAGE

Unless the analysis of sea water for micronutrients can be commenced within 1 or 2 hr in temperate seas or within an hour or less in the tropics, samples must be stored in a cool dark place. If the analysis must be delayed for more than a few hours the samples should be frozen solid at a temperature not exceeding –20 C. This is quite feasible when plastic containers are used and few glass vessels will break unless they are over-filled up to a "neck" or constriction. We have found no evidence of changes in micronutrient concentrations at these low temperatures over a period of very many weeks. Samples from warm tropical inshore waters with a high biotic content should be frozen as rapidly as possible in some form of liquid cooling bath but in subarctic regions it is generally sufficient to put samples in a domestic-type "deep freeze" working at its lowest temperature setting. Such equipment is becoming

mandatory for each ship and shore-base laboratory undertaking micronutrient analysis. Samples for photosynthetic rate determinations should never be stored at temperatures differing more than a few degrees from the euphotic zone temperature. Samples used in the determination of particulate organic material may be chilled to near freezing but ice must not be allowed to form for cell rupture can occur with possible loss of soluble organic matter. Once frozen samples are thawed all analyses should be undertaken without delay. Repeated freezing and thawing of the same sample in polyethylene containers is bad practice and has been found to give low results for several inorganic micronutrients.

TUBE AGITATOR

In many of the methods described in Part IV it is necessary to mix the contents of small tubes in order to get a uniform suspension of particles or to keep the contents of a tube well mixed during the addition of certain reagents. Although this can be achieved by shaking or inverting a tube there are several practical drawbacks and disadvantages to such methods and we strongly recommend the use of a "tube buzzer." This consists of a rubber bung or a cylinder of plastic-covered metal which has two flattened sides and which is rotated rapidly on its axis by a small electric motor. The test tube is pressed hard against this rotating block causing a violent agitation of the liquid in the tube. A piece of apparatus designed specifically for this purpose is made by Hallikainen Instruments, Berkeley, California, USA, and one of a different design by Clay-Adams Company (the Cyclo-Mixer).

PART I. SALINITY, DISSOLVED OXYGEN, CARBONATE AND SULPHIDE

I.1. DETERMINATION OF SALINITY BY TITRATION (HIGH PRECISION METHOD)

DEFINITIONS

CHLORINITY

The halogen ions (other than fluoride) in sea water are normally estimated by argentimetry. To prevent ambiguity arising from changes in the accepted atomic weights of silver and chlorine the chlorinity, $Cl\%$, of sea water is defined as 0.3285234 times the weight of silver precipitated as silver halides from 1 kg of sea water, all weighings being *in vacuo*.

CHLOROSITY

This value, $Cl/liter_t$, is the quantity determined by volumetric methods and is defined in the same manner as chlorinity except that the sample unit is 1000 ml of sea water at a stated temperature rather than 1 kg of sea water weighed *in vacuo*.

SALINITY¹

The content of dissolved salts in sea water is usually expressed as salinity, $S\%$, a convention which approximates to the weight in grams, *in vacuo*, of the solids obtained from 1 kg of sea water (weighed *in vacuo*) when the solids have been dried to constant weight at 480 C, the organic matter completely oxidized, the bromide and iodide replaced by an equivalent amount of chloride, and carbonates converted to oxides. Ocean water contains slightly more salts (halides, carbonate, and bicarbonate) than is expressed by its salinity value. In practice, the salinity is defined in terms of chlorinity by the Knudsen equation:

$$S\% = 0.030 + 1.8050 Cl\%$$

This equation is *solely a definition* and has no universal applicability in any practical chemical sense.

INTRODUCTION

Despite recent developments in salinity measurement based on electrical conductivity, density, or the refined measurement of refractivity, a silver nitrate titration still remains the internationally acceptable referee procedure and it is also still the most convenient method to use when a high precision is required in a laboratory having only limited and sporadic requirements for salinity analyses.

In essence, all titration methods compare the amount of precipitable halide halogen ion in a sample of sea water with the amount precipitated by silver ion from a seawater sample provided by the Laboratoire Hydrographique (Copenhagen) and standardized in a manner independent of a knowledge of atomic weights (Jacobsen and Knudsen, *Assoc. Océanog. Phys. Publ. Sci.*, (7), Liverpool, 1940; see also the

¹A new definition of salinity, based on conductivity, is given by Wooster, Lee and Dietrich, *Limnol. Oceanogr.* 14: 437, 1969.

definition *above*). The exact technique for carrying out the titrations involved and the method used for determining end points are largely a matter of choice but recently definitive recommendations have been made in a report of the International Council for the Exploration of the Sea 'Sub-committee for Considering Standard Methods for Salinity Determination' (Hermann, Kalle, Koczy, Maniece, and Tchernia, *J. Conseil, Conseil Perm. Intern. Exploration Mer*, 24: 429, 1959).

The method described below deviates relatively little from these recommendations and is well adapted to routine use. A less subjective end point, such as a potentiometric end point, might be worth considering (e.g. Bather and Riley, *J. Conseil, Conseil Perm. Intern. Exploration Mer*, 18: 277, 1953) or the classical Mohr end point using chromate, used here, could perhaps be replaced by a more modern indicator. A useful critical evaluation of such indicators is given by Van Landingham (*J. Conseil, Conseil Perm. Intern. Exploration Mer*, 22: 174, 1957) who favours phenosafranin above all others. Only slight modifications to the method described here would be necessary if this end-point detector were used.

The method of calculation and the use of tables described here seem to us to be more convenient than the more usual procedure described in the well-known Hydrographical Tables (Knudsen, G.E.C. Gad. Copenhagen, 1953). However, errors can occur from approximations in our tables to the extent of some 0.005‰ in salinity. Considering the precision of the method this is scarcely significant and only when the most precise work is being attempted, taking the *mean of at least four replicate results*, will a more exact conversion of chlorosity to salinity be warranted.

METHOD

A. CAPABILITIES

Range: Salinity 30–40‰

PRECISION AT THE 33‰ SALINITY LEVEL

The correct value lies in the range:

$$\text{Mean of } n \text{ determinations } \pm 0.023/n^{1/2}\text{‰}$$

Duplicate titrations should always be made. Reject *both* titrations if they differ by more than 0.025–0.030 ml of silver nitrate solution.

B. OUTLINE OF METHOD

The precipitable halide halogens in a 15-ml volume of seawater sample are determined by titration with a silver nitrate solution using a chromate end point, the Mohr titration. The silver nitrate solution is standardized against 15 ml of a seawater standard of known chlorinity ("Eau de Mer Normale"), obtainable from the Depot d'Eau Normale, Laboratoire Hydrographique, Charlottenlund Slot, Copenhagen, Denmark. Corrections are made to allow for temperature and density, so as to convert titration values to chlorinity, from which salinity values are obtained. Special Knudsen-type automatic pipettes and burettes are used.

C. SPECIAL APPARATUS AND EQUIPMENT

The special Knudsen-type automatic pipette and burette designed for this determination must be used. The latter should have a calibration certificate or must be calibrated. Arrangements are made for vacuum to suck samples into the pipette and for pressure to fill the burette from a large reservoir of silver nitrate. The titration is conducted in a 200-ml tall-form beaker with rapid magnetic stirring. An automatic dispenser of diluting solution, containing the chromate indicator, is advantageous. Centigrade thermometers, read to the nearest tenth of a degree, are used to measure the temperature of the silver nitrate solution and the seawater samples immediately prior to or after a titration. The titration should be carried out against a white background in the "yellow" light of an ordinary electric light bulb rather than in daylight or in the light of an artificial-daylight lamp. The pipette top should be lubricated with a little glycerol and the tap of the burette with a trace of paraffin (not silicone) stopcock grease. The volumetric glassware must be kept spotlessly clean by soaking periodically for a few minutes in a cold 5% solution of sodium hydroxide in methyl alcohol and then rinsing with nitric acid followed by distilled water.

D. SAMPLING PROCEDURE AND SAMPLE STORAGE

Use standard flat 8-oz medicinal bottles for collecting, handling, and storing samples used for salinity determinations. The bottles manufactured for use with size No. 6 corks (19–15 mm diam) should be used. The corks should be soaked for 30–40 sec in melted paraffin wax, drained, and dried by placing them on a wire screen. Extruded excesses of wax are removed. The bottles are rinsed thoroughly three times with the sample and then filled to the shoulder. They are sealed by forcing the waxed corks down to a few millimeters below the level of the neck. A further seal should be made within a few days by dipping the neck in melted wax. No changes in salinity will then result over a period of many years.

When these bottles, or the containers of Eau de Mer Normale, are opened the salinity determination must be carried out within a few minutes. Repeat determinations on *re-corked* bottles should not be delayed for more than about 1 hr.

E. SPECIAL REAGENTS REQUIRED

1. STANDARD SEA WATER

The primary standard for this method must be a sample of Eau de Mer Normale with a stated $Cl\%$ value (approximating 19.38). To conserve this primary standard, it is best to prepare a large volume (10–20 liters) of a secondary standard consisting of filtered sea water (preferably collected below 50 m in the open ocean) with a chlorinity exceeding 18‰. This sample is stabilized by adding a few crystals of thymol and is then quickly put into sample bottles (*see* Sect. D). Every tenth bottle is opened and analysed in duplicate by the method described below using a silver nitrate solution that has been standardized by Eau de Mer Normale. The mean of *ten or more* such duplicates is taken as the chlorosity (20 C) of the secondary standard.

2. SILVER NITRATE SOLUTION (APPROXIMATELY 0.21 N)

Dissolve 37 g of good quality silver nitrate for each liter of final solution. Use distilled water and store the solution in a dark bottle. It is desirable to make this solution in units of at least 20–40 liters when large numbers of samples are to be analysed. This solution will require dilution with a little water to bring it to the desired strength, as described in Section H. The solution should be well mixed in the bottle once or twice each day or prior to each batch of titrations.

3. INDICATOR-DILUENT SOLUTION

Dissolve 3.5 g of analytical quality potassium chromate, K_2CrO_4 , in each liter of distilled water.

F. EXPERIMENTAL

Add 15.00 ml of sample to a 200-ml spoutless tall-form beaker by means of the automatic Knudsen-type pipette and add 15 ml of indicator-diluent solution. The titration is made from a Knudsen-type automatic bulb burette, the graduations of which generally commence at about 16.7. (This burette delivers twice the volume indicated by the graduations, to obtain an increased sensitivity.) The contents of the beaker must be vigorously stirred before and at the end point. It is best to commence stirring after the bulb has about two thirds emptied. About 1 ml before it is judged that the end point is reached rinse the sides of the beaker with a little distilled water from a wash bottle.

As the end point approaches, the localized red precipitate formed by the silver solution will begin to spread throughout the solution. At the end point the pale greenish-yellow colour of the contents of the beaker changes to a full yellow and then becomes a definite pale red as the end point is exceeded. The exact point is largely subjective and errors in its estimation are allowed for to some extent in the standardization procedure (*see* Sect. H). However, the permanence of any supposed end point should be checked by waiting for about 5 sec. If the colour is not permanent a further small drop of silver nitrate solution (0.04 ml or less) should be added. Record the burette reading *immediately* to the nearest tenth of a graduated division (0.001). Note the temperature of the silver nitrate and sample (to the nearest 0.1 C) before each titration.

The following routine has been suggested as a means of attaining maximum speed in the analysis of a batch of samples when suction for the pipette and pressure for filling the burette and indicator-diluent dispenser are available. A small sink and supply of distilled water for rinsing beakers should be at hand.

Whilst the bulk of the silver nitrate is running into a sample being titrated (*say* Sample I):

1. Fill the pipette with the next sample (Sample II) having noted its temperature.
2. Fill the indicator-diluent solution dispenser.
3. Rinse the beaker which has been left draining after titrating the sample immediately before Sample I.
4. Close the pipette and indicator-diluent dispenser as these become full.
5. Remove the sample bottle from under the pipette with one hand and, at the

same time, dry the stem and tip of the burette with a small piece of rag or absorbent tissue held in the other hand.

6. Place the 200-ml beaker under the pipette and under the indicator-diluent dispenser simultaneously and open the taps to allow these two solutions to enter the beaker. Whilst the pipette is emptying and draining complete the titration of Sample I and remove the cork from the next sample to be analysed.

7. Stop the stirrer and record the titration for Sample I.

8. Remove the beaker from under the burette and empty it.

9. Touch the tip of the pipette on the side of the beaker containing Sample II, to empty it properly, then transfer this beaker from beneath the pipette to beneath the burette.

10. Note the temperature of the silver nitrate solution shown on a thermometer placed in a small tube through which the solution flows before entering the burette.

11. Fill the burette with silver nitrate solution and start the titration.

12. Commence the cycle again at 1, above.

G. CALCULATIONS

Let V be the reading of the Knudsen burette, taken to three decimals.

Let C_b be the burette correction (positive or negative). This depends on the magnitude of the titration and is given by the manufacturer's calibration certificate. It rarely exceeds ± 0.005 .

Let C_s be the standardization correction (positive or negative) obtained as described in Section H. This correction should not exceed 0.05–0.1.

Let C_t be the temperature correction. This correction, which rarely exceeds a positive or negative value of 0.025, depends upon the reading V and the difference in temperature ($T_{Ag} - T_{Cl}$) between the silver nitrate solution and the sample. It is obtained from Table I. ($T_{Ag} - T_{Cl}$) should never exceed 5 C and is preferably kept below 3 C. In making this correction it is assumed that, in the range of say 14–26 C, the expansion of sea water and silver nitrate solutions are small and equal to each other. If this is the case, the corrected titre so obtained is independent of temperature and is thus correct for 20 C.

Calculate the chlorosity at 20 C from the expression:

$$Cl/liter_{(20)} = V + C_b + C_s + C_t$$

Evaluate the salinity from this chlorosity value using Table II, which shows the relation between $Cl/liter_{(20)}$ and $S\%$.

H. CALIBRATION

USE OF EAU DE MER NORMALE

1. Evaluate the chlorosity (V_a) of the primary standard sea water, Eau de Mer Normale, from the equation

$$V_a = Cl/liter_{(20)} = Cl\% \times \rho_{20} = V_a$$

where $Cl\%$ is the stated chlorinity and ρ_{20} is the density of sea water of this chlorinity when at 20.0 C. (ρ_{20} for water of a $Cl\%$ value between 19.37 and 19.38

may be taken as 1.0248.) Other values are obtained from Knudsen's Hydrographic Tables.

2. Adjust the strength of the silver nitrate solution by adding small amounts of water to the solution prepared as in Section E, until the value of

$$V_o = V + C_b + C_i$$

obtained as described in Sections F and G, is *within 0.1 or less* of the chlorosity of the standard (V_a) at 20 C. Finally evaluate V_o as the mean of at least twenty determinations having a spread less than 0.030.

3. The standardization correction, C_s , for any determination will depend upon the value of $V_a - V_o$, obtained above, and the magnitude of V for the particular determination. Calculate correction intervals, v , given by the formula:

$$v = \frac{2V_o}{200(V_a - V_o) + 1}$$

The experimental values of V are classified according to the number of multiples of v that they contain and the C_s values are read from a table constructed by each worker, of the form:

V	C_s
0.00 to v	0.000
v to $2v$	$(V_a - V_o)v / V_o$
$2v$ to $3v$	$2(V_a - V_o)v / V_o$
$3v$ to $4v$	$3(V_a - V_o)v / V_o$

Values of C_s should be calculated to the nearest 0.001, although the above approximation, which does away with the necessity of five-place calculators, can give C_s values in error by as much as 0.005. Normally only one or two ranges involving high multiples of v are necessary to cover any likely values of V , provided that V_o and V_a are near enough to each other.

USE OF SECONDARY SEAWATER STANDARD

Use the silver nitrate solution, calibrated as described above, to determine the $Cl/liter_{(20)}$ value for the secondary standard (*see* Sect. E.) as the mean of ten or more duplicate determinations, a duplicate being carried out on every tenth bottle. This secondary standard should be used in preference to the Eau de Mer Normale for all routine work. The value for C_s must be determined by each worker at the commencement of each day of titrations by using a fresh bottle of secondary standard and finding the value of V_o as a mean of *five* determinations having a spread less than 0.030. A check of V_o should be made every 1–2 hr throughout the day or after every major break in the titration routine that may occur during the day. If the value of V_o so obtained differs by more than 0.025 from the previous mean value, a new table for C_s should be constructed using the mean of a fresh set of five V_o determinations.

I.2. DETERMINATION OF SALINITY BY TITRATION (LOW PRECISION METHOD)

INTRODUCTION

For work in brackish waters and the surface waters of some coastal inlets and for many biological purposes the analysis described in Part I.1 may be unnecessarily precise and time consuming. The following modification is recommended when a rapid method, correct to about 0.05 to 0.1‰ of salinity, is adequate.

METHOD

A. CAPABILITIES

Range: Salinity 4–40‰

PRECISION AT THE 30‰ SALINITY LEVEL

The correct value lies in the range:

$$\text{Mean of } n \text{ determinations } \pm 0.06/n^{1/2}\text{‰}$$

A duplicate titration on each sample is not necessary but should be made on about one sample in five. Duplicates are unacceptable if they differ by more than about 0.06 ml of silver nitrate solution.

B. OUTLINE OF METHOD

The precipitable halide halogens in a 10-ml volume of sea water are determined by titration with a silver nitrate solution using a chromate end point, the Mohr titration. The silver solution is standardized against 10 ml of sea water of known chlorosity.

C. SPECIAL APPARATUS AND EQUIPMENT

An automatic 10-ml pipette and an automatic zero-adjusting 25-ml burette are required. An automatic dispenser of diluting solution, containing the chromate indicator, is advantageous. The titration is carried out in a 200-ml tall-form beaker, with magnetic stirring, against a white background in "yellow" artificial light from an ordinary electric light bulb. The pipette top should be lubricated with a little glycerol and the tap of the burette with a trace of paraffin (not silicone) stop-cock grease. The volumetric glassware must be kept spotlessly clean by soaking periodically for a few minutes in a cold 5% solution of sodium hydroxide in methyl alcohol and then rinsing with nitric acid followed by distilled water.

D. SAMPLING PROCEDURE AND SAMPLE STORAGE. (*Refer to Part I.1*)

E. SPECIAL REAGENTS REQUIRED

1. STANDARD SEA WATER

Prepare a large volume (10–20 liters) of a standard consisting of filtered sea water (preferably collected below 50 m in the open ocean) with a chlorinity near to 18‰. This sample is stabilized by adding a few crystals of thymol and is then quickly put into sample bottles (*see Part I.1*). Every tenth bottle is opened and analysed

in duplicate by the high-precision method. The mean of ten or more such duplicates is taken as the chlorosity (20 C) of this standard sea water.

2. SILVER NITRATE SOLUTION (APPROXIMATELY 0.28N)

Dissolve 49 g of good quality silver nitrate for each liter of final solution. Use distilled water and store the solution in a dark bottle. The solution may need dilution with a little water to bring it to the desired strength, as described in Section H. The solution should be well mixed in the bottle once each day or prior to each batch of titrations.

3. INDICATOR-DILUENT SOLUTION

Dissolve 3.5 g of analytical quality potassium chromate, K_2CrO_4 , in each liter of distilled water.

F. EXPERIMENTAL

Add the sample of sea water to a 200-ml spoutless tall-form beaker by means of the automatic 10-ml pipette and then add 15 ml of indicator-diluent solution. Titrate the solution from the 25-ml automatic burette. About 1 ml before it is judged that the end point is reached, rinse the sides of the beaker and stirrer with a little distilled water from a wash bottle.

As the end point approaches, the localized red precipitate formed by the silver solution will begin to spread throughout the solution. At the end point the pale greenish-yellow colour of the contents of the beaker changes to a full yellow and then becomes a definite pale red as the end point is exceeded. The exact point is largely subjective and errors in its estimation are allowed for to some extent in the standardization procedure (*see* Sect. H). Record the burette reading to the nearest 0.01 ml. Note the average temperature of the samples T_{Cl} for each titration period of 1–2 hr (say every 20 or 30 samples) by a thermometer placed in a tightly packed case of bottles that has already equilibrated with the laboratory temperature. Note the average temperature T_{Ag} of the silver nitrate solution during the same period shown on a thermometer placed in a small tube through which the solution flows before entering the burette. If possible, T_{Ag} should be kept greater than T_{Cl} and the difference between the two should not exceed 5 C.

The sequence of operations described in Part I.1 can be used in the present method when the maximum speed is required for routine analyses.

G. CALCULATIONS

Let V be the reading of the burette, taken to two decimal places.

Let C_b be the burette correction (positive or negative). This depends on the magnitude of the titration and is given by the manufacturers or should be determined (*see* standard text books on analysis). It should rarely exceed ± 0.05 ml.

Let C_s be the standardization correction, obtained as described in Section H. This correction should not exceed 0.15 ml.

Let C_t be the temperature correction which depends upon the reading V and the difference in the temperature ($T_{Ag} - T_{Cl}$) between the silver nitrate solution and the sample. The correction C_t may be neglected unless ($T_{Ag} - T_{Cl}$) exceeds 3 C

and V is greater than 15 ml. Should some measure of the temperature correction be thought desirable read C_t from Table I. Calculate the chlorosity at 20 C from the expression:

$$Cl/liter_{(20)} = V + C_b + C_s + C_t$$

Evaluate the salinity from this chlorosity value from Table II which shows the relation between $Cl/liter_{(20)}$ and $S\%$.

H. CALIBRATION

1. Adjust the strength of the silver nitrate solution by adding small amounts of water to the solution prepared as in Section E, until the value of

$$V_c = V + C_b + C_t$$

is within 0.1 or less of the chlorosity of the standard at 20 C (expressed in milliliters as V_a).

2. Evaluate V_c as the mean of five determinations, having a spread less than 0.06 ml, each day before commencing a batch of analysis.

3. The standardization correction, C_s , for any determination will depend upon the value of $(V_a - V_c)$, obtained above, and the magnitude of V for the particular determination. Calculate correction intervals, v , given by the formula:

$$v = \frac{2V_c}{200 (V_a - V_c) + 1}$$

The experimental values of V are classified according to the number of multiples of v that they contain and the C_s values are read from a table constructed by each worker, of the form:

V	C_s
0.00 to v	0.000
v to $2v$	$(V_a - V_c)v / V_c$
$2v$ to $3v$	$2(V_a - V_c)v / V_c$
$3v$ to $4v$	$3(V_a - V_c)v / V_c$

Values of C_s should be calculated to the nearest 0.01 ml.



I.3. DETERMINATION OF DISSOLVED OXYGEN

INTRODUCTION

The method described here is a modification of the classical Winkler procedure which we are convinced still remains the most reliable and precise means of analysing for dissolved oxygen in sea water. If a very precise estimate of *extremely low* oxygen concentrations is required on a routine scale then an absorptiometric determination of the iodine liberated in the Winkler method may prove superior to a titration procedure (Oulman and Baumann, *Sewage Ind. Wastes*, 28: 1461, 1956) but not unless oxygen concentrations are less than about 0.1 mg-at/liter.

The thiosulphate titration of iodine may be completed using a variety of electrochemical end-point detectors (a good account is given by Knowles and Lowden, *Analyst*, 78: 159, 1953) but we have found that none of these methods gives a noticeably better *precision* than does the classical starch end point when used with proper illumination. The true stoichiometric end point is a little after the starch end point but this error is barely significant in marine work.

The accuracy of the Winkler method has recently been examined in detail by Carpenter. His findings (*Limnol. Oceanog.*, 10: 135, 1964) and a description of the results of a comparative experiment carried out in the USA and Canada (Carritt and Carpenter, *J. Marine Res.*, 24: 286, 1966) fully evaluate this approach and should be read by the analyst desirous of attaining the maximum possible accuracy. The following procedure is little different from the optimum technique suggested by Carpenter.

METHOD

A. CAPABILITIES

Range: 0.005–8 mg-at/liter

PRECISION AT THE 0.7 MG-AT/LITER LEVEL

The correct value lies in the range:

Mean of n determinations $\pm 0.003/n^{\frac{1}{2}}$ mg-at/liter.

This is the highest precision considered likely for work in a shore-base laboratory under near ideal conditions, using thiosulphate standardized by the mean of at least five titrations. Under routine conditions at sea the uncertainty range will be appreciably greater, perhaps nearly doubled. Comparison of the starch end point described here with an electrometric end point shows that there is a slight negative error which is *not* allowed for in the standardization when low oxygen concentrations are being estimated. Oxygen concentrations below 0.1 mg-at/liter or less will be *up to 0.0015 mg-at/liter too low*. This amount is scarcely significant.

B. OUTLINE OF METHOD

A divalent manganese solution, followed by strong alkali, is added to the sample. The precipitated manganous hydroxide is dispersed evenly throughout the seawater sample which completely fills a stoppered glass bottle. Any dissolved oxygen rapidly oxidizes an equivalent amount of divalent manganese to basic

hydroxides of higher valency states. When the solution is acidified in the presence of iodide the oxidized manganese again reverts to the divalent state and iodine, equivalent to the original dissolved oxygen content of the water, is liberated. This iodine is titrated with standardized thiosulphate solution.

C. SPECIAL APPARATUS AND EQUIPMENT

300-ml BOD (biological oxygen demand) bottles.

50-ml pipette and a 10-ml burette graduated in units of 0.05 ml or less. The burette should have an automatic zero adjuster and an automatic "Lowy" type of pipette is recommended. (This type has a two-way tap at the top of the pipette.) Alternatively titrations can be conveniently carried out using a 1.00-ml microburette. The Gilmont Ultramicroburette made by the Manostat Corporation of 26 N Moore Street, New York 13, N.Y., USA, is suitable and can easily be read to 0.001 ml.

125-ml conical flasks painted white *on the outside* over the base and two thirds of the way around the sides. The flasks should be illuminated through the unpainted portion of the side during titration by means of an ordinary filament electric light bulb. The contents of the flask are best stirred during titration by a white magnetic stirring bar.

D. SAMPLING PROCEDURE AND SAMPLING STORAGE

BOD bottles are rinsed twice with the sample being analysed. If the sample is obtained from a reversing bottle a length of rubber tubing should be taken from the tap to the bottom of the BOD bottle and sea water introduced in such a way as to minimize turbulence and agitation of the sample. The end of the rubber tube must always be kept beneath the surface of the water as the bottle is filled. Water is allowed to overflow from the top of the BOD bottle which is stoppered at once. A volume of water at least equal to the volume of the BOD bottle should be allowed to overflow, more if the oxygen content of the water is suspected to be very low. No air should remain in the bottle. When the sample is taken from a bucket (e.g. surface samples), rinse the bottle twice and then allow the water to flow in by submerging the bottle to the mouth and gently tipping it so that the sample enters with no bubbling and a minimum of turbulence. For work of the highest accuracy the sample should be siphoned into the bottle.

Samples must be drawn into the BOD bottles *immediately* after they are taken and should be the first samples to be drawn from a reversing bottle. This is particularly important when using Van Dorn bottles of large capacity and when analysing water from a depth where there is considerable undersaturation with respect to oxygen. The sampling delay should never exceed 15 min. When the bottles are filled the analysis should be commenced in less than 1 hr as oxygen may be lost when the samples warm to room temperature or by microbiological respiration. Store the samples in the dark or in subdued light to minimize photosynthesis by any phytoplankton that may be present. If the analysis must be delayed, "pickle" the samples by adding the manganous sulphate and alkaline iodide solutions (*see Sect. F below*). The rest of the analysis may be completed at leisure.

Storage of oxygenated sea water in contact with brass sampling bottles causes

an appreciable loss of the element due to oxidation of the metal. The effect is worse with new bottles and most serious on deep casts (below 1000 m) or if the bottles are kept on deck for any length of time before the water is withdrawn. "Aged" bottles give less trouble but they are best coated with tin or plastic and samples must be withdrawn directly they reach the deck.

E. SPECIAL REAGENTS

1. MANGANOUS SULPHATE REAGENT

Dissolve 480 g of manganous sulphate tetrahyde, $\text{MnSO}_4 \cdot 4\text{H}_2\text{O}$,
or 400 g of manganous sulphate dihydrate, $\text{MnSO}_4 \cdot 2\text{H}_2\text{O}$,
or 365 g of manganous sulphate monohydrate, $\text{MnSO}_4 \cdot \text{H}_2\text{O}$,

in distilled water and make the volume to 1 liter. The salt must be of analytical reagent grade to ensure the absence of ferric iron.

2. ALKALINE IODIDE SOLUTION

Dissolve 500 g of sodium hydroxide in 500 ml of distilled water. Dissolve 300 g of potassium iodide in 450 ml of distilled water and mix the two solutions. A great deal of heat will be liberated. Both the sodium hydroxide and potassium iodide used in this method should be of analytical reagent grade.

3. STANDARD THIOSULPHATE SOLUTION (See SECT. H.)

4. STARCH INDICATOR SOLUTION

Prepare a 0.1–0.2% solution of soluble starch. A semipreserved solution (stable for several months) may be made as follows:

Suspend 2 g of soluble starch in 300–400 ml of water. Add an approximately 20% solution of sodium hydroxide with vigorous stirring until the solution becomes clear (a slight permanent opalescence may remain) and allow the solution to stand for 1–2 hr. Add concentrated hydrochloric acid until the solution is *just* acid to litmus paper and then add 2 ml of glacial acetic acid. Finally dilute the solution to 1 liter with distilled water. Discard the solution when the end-point colour is no longer a pure blue and takes on a green or brownish tint.

F. EXPERIMENTAL

PROCEDURE

1. Remove the stopper from the BOD bottle and add 1.0 ml of manganous sulphate reagent with an automatic pipette followed at once by 1.0 ml of alkaline iodide solution (Note *a*). Restopper the bottle immediately and mix the contents thoroughly by shaking until the precipitated manganous–manganic hydroxide is evenly dispersed. No air bubbles should be trapped in the bottle.

2. When the precipitate has settled slightly (in 2–3 min) shake the bottles again. Finally allow the samples to stand until the precipitate has settled at least one third of the way down the bottle leaving a clear supernatant solution (Note *b*). It is best practice to allow the solution to warm to room temperature at this stage (Note *f*).

3. Add 1.0 ml of concentrated (sp gr 1.84) sulphuric acid, restopper the

bottle and mix so that all the precipitate dissolves (Notes *c* and *d*). No air should be trapped in the bottle. (Note *e*).

4. Within an hour or so of acidification (Note *f*) transfer 50.0 ml of solution (100 ml if desired for oxygen contents less than about 0.1 mg-at O₂/liter) into a specially painted conical flask by means of a pipette. Titrate *at once* with standard 0.01 N thiosulphate solution until a very pale straw colour remains. Add 5 ml of starch indicator and conclude the titration (Note *g*).

5. Alternatively (Note *g*) nearly the whole contents of the BOD bottle can be titrated with standard 0.5 N thiosulphate. Pour off 20 ± 0.5 ml into a 25-ml graduated measuring cylinder. Place a small magnetic stirring bar into the bottle and titrate with the stem of the Gilmont microburette well immersed in the bottle. Use 10 ml of starch solution to detect the end point.

6. Subtract any blank correction (*see* Sect. G) from the titration to obtain the corrected titration, *V* ml, and calculate the oxygen content of a sample from the formulae:

$$\text{mg-at O}_2/\text{liter} = 0.1006 \times f \times V$$

when a 50.0-ml aliquot is taken from a 300-ml BOD bottle (Note *h*) or

$$\text{mg-at O}_2/\text{liter} = \frac{Y}{Y-2} \times \frac{5.00}{X} \times f \times V$$

when a *X*-ml aliquot is taken from a *Y*-ml bottle.

If the content of the BOD bottle, less 20 ml, is titrated with 0.5 N thiosulphate the expression becomes

$$\text{mg-at O}_2/\text{liter} = \frac{250}{Y-22} \times f \times V$$

In the above expressions *f* is a factor obtained as described in Section H.

The milliliters of oxygen at NTP present in a liter of water can be calculated from the expression:

$$\text{ml O}_{2(\text{NTP})}/\text{liter} = 11.20 \times \text{mg-at O}_2/\text{liter}$$

Similarly:

$$\text{mg O}_2/\text{liter} = 16.00 \times \text{mg-at O}_2/\text{liter}$$

NOTES

(a) Place the pipette *just* beneath the surface of the water in the BOD bottle. The dense reagent solutions sink at once and as a result only sea water is displaced from the bottle. The outside of the alkaline iodide pipette should not get contaminated with manganese solutions, for if this occurs, manganese is transferred to the alkaline iodide reagent bottle. Should a precipitate of higher-valency manganese basic oxides appear in the alkaline iodide reagent it must be discarded.

(b) The sample can be allowed to stand indefinitely at this stage provided thermal contraction does not draw air into the bottle.

(c) The top of the pipette should be placed just beneath the surface. The acid sinks and displaces about 1 ml of solution but this contains no oxygen if the precipitate in the bottle has settled adequately.

(d) If the oxygen content exceeds about 0.6 mg-at O_2 /liter a dark brown or black precipitate may persist in the bottle after the contents have been acidified. This will dissolve if the solution is kept for a few minutes longer than usual. If the precipitate is particularly stubborn, a few more drops of sulphuric acid will generally effect dissolution. A slight precipitate can be ignored provided that it is well dispersed throughout the solution before aliquots are taken.

(e) A little carbon dioxide may be liberated when solutions are acidified but this causes no harm.

(f) The acidified iodine solution is stable for many hours or days in most instances but if the water sample contains much organic matter this may be slowly oxidized by the iodine. It is advisable, therefore, not to delay the titration. If samples were initially much colder than the temperature of the laboratory they should either be titrated at once or allowed to warm up before acidification. If iodine solutions are allowed to expand on heating to room temperature a small error will be introduced, although this is probably negligible in most instances. Iodine solutions in the BOD bottles or titration flasks must be kept out of direct sunlight.

(g) This titration must not be delayed and thiosulphate should be added fairly rapidly. Solutions should remain colourless for at least 20 sec at the end point. A creeping end point is due to atmospheric oxidation of iodide to iodine which becomes increasingly rapid as the pH is lowered. At the present pH (*ca.* 1.3) no trouble should be encountered for many minutes. Another source of error, the volatilization of elemental iodine, depends mainly on temperature and is not serious in the present method at temperatures less than about 25C provided that titrations are rapid and are commenced directly aliquots are added to the conical flask. The top few milliliters of iodide solution sucked up into a 50-ml pipette should be drawn over and discarded as they will be slightly deficient in iodine. In very hot laboratories the 50-ml aliquot should be run into a few milliliters of distilled water in the conical flask to which a little potassium iodide (1–2 g) has been added to suppress further the vapour pressure of iodine. For the most accurate work the whole content of the BOD bottle can be titrated with 0.5N thiosulphate using a microburette after first removing a small measured volume to allow for the addition of starch.

(h) It is assumed that a BOD bottle has a volume of 300 ml. These bottles will generally be found to be within a few per cent of their nominal volume. Even if they were several milliliters out no significant error would be introduced when 50- or 100-ml aliquots are used. If the whole content (less 20 ml) of the BOD bottle is titrated with a microburette the exact volume of the bottle, Y , becomes more important and should be found (by weighing empty and full of water) and etched on each BOD bottle.

G. DETERMINATION OF BLANK

The calibration procedure described in the next section is also used for the blank determination except that no iodate is added. If analytical reagent quality chemicals are used there should be no blue colour with starch. If a slight colouration results a blank correction may be ascertained by titrating with thiosulphate until the solution is colourless. If this blank correction exceeds 0.1 ml, the reagents are suspect and should be prepared afresh. The potassium iodide or manganous reagent is generally the cause of the trouble. If no blue colour is formed on adding starch, check that a blue colour *does* result when 0.1 ml or less of 0.01 N iodate is added. This guards against the presence of reductants. The blank testing should be undertaken when each new batch of reagents is prepared.

H. CALIBRATION

1. APPROXIMATELY 0.5 N THIOSULPHATE SOLUTION

(Prepare only if a microburette titration is desired.)

Dissolve 145 g of good grade sodium thiosulphate, $Na_2S_2O_3 \cdot 5H_2O$ and 0.1 g

of sodium carbonate Na_2CO_3 in 1 liter of water. Add 1 drop of carbon bisulphide, CS_2 , per liter as a preservative. The thiosulphate solution should be prepared many liters at a time and is stable for many months in a dark well-stoppered bottle kept below 25 C. The factor (*see below*) will slowly decrease.

$$1.0 \text{ ml of } 0.5 \text{ N thiosulphate} = 0.25 \text{ mg-at O}_2$$

2. APPROXIMATELY 0.01 N THIOSULPHATE SOLUTION

Prepare as above using only 2.9 g of sodium thiosulphate per liter.

Note: Dilute thiosulphate solution in a burette and the tubing connecting an automatic burette to a stock of the reagent will deteriorate quite rapidly and the burette and tubing should be flushed several times with new solution before titrations are recommenced after any shutdown period exceeding a few hours.

3. EXACTLY 0.100 N IODATE SOLUTION

(Prepare only if a microburette titration is desired.)

Dry a little analytical reagent quality potassium iodate, KIO_3 , at 105 C for 1 hr. Cool and weigh out exactly 3.567 g. Dissolve the salt in 200–300 ml of water, warming slightly. Cool, transfer to a 1000-ml measuring flask and make to the mark with distilled water. This solution is stable indefinitely.

4. EXACTLY 0.0100 N IODATE SOLUTION

Prepare as above using exactly 0.3567 g of KIO_3 .

5. DETERMINATION OF THE FACTOR f

Fill a 300-ml BOD bottle with sea water, or with distilled water, and add 1.0 ml of concentrated sulphuric acid and 1.0 ml of alkaline iodide solution and *mix thoroughly*. Finally add 1.0 ml of manganous sulphate solution and mix again. Withdraw approximately 50-ml aliquots into the titration flasks. Use one or two flasks for blank determinations if necessary (*see G above*), and to the other add 5.00 ml of either 0.100 N or 0.0100 N iodate from a clean 5-ml pipette which should be calibrated as a check on the volume. Allow the iodine liberation to proceed for at least 2 min but not for more than 5 min, during which time the solution should be at a temperature below 25 C and out of direct sunlight. Titrate the iodine with the appropriate thiosulphate solution. If v is the titration in milliliters then

$$f = \frac{1.00}{v} \text{ for the } 0.5 \text{ N thiosulphate}$$

or

$$f = \frac{5.00}{v} \text{ for the } 0.01 \text{ N thiosulphate.}$$

The mean value of f should be found from at least three and preferably five replicates.

1.4. DETERMINATION OF CARBONATE, BICARBONATE, AND FREE CARBON DIOXIDE FROM pH AND ALKALINITY MEASUREMENTS

DEFINITIONS

TOTAL ALKALINITY

Total alkalinity is the number of milliequivalents of hydrogen ion that are neutralized by 1 kg of sea water when a large excess of acid is added. This approximates closely to the acid required to titrate a solution to the pH inflection point near pH 4.5. The total alkalinity is often expressed per liter (20 C) rather than per kilogram. A volume basis is used in the tables and equations in the present method.

SPECIFIC ALKALINITY

This is defined as either of the ratios:

$$\frac{\text{total alkalinity (kilogram basis)}}{Cl\%} = \frac{\text{total alkalinity (liter basis)}}{Cl/\text{liter}_{(20\text{ C})}}$$

and is about 0.123. The ratio may vary appreciably, however, according to the nature of the water mass concerned and must be determined experimentally for the most precise work.

CARBONATE ALKALINITY

The carbonate alkalinity is the number of milliequivalents of hydrogen ion that are neutralized by 1 kg of sea water (or 1 liter at 20 C in the present method) in converting carbonate and bicarbonate ions to carbon dioxide by the reactions:

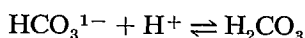
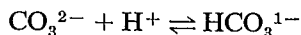

In all natural sea waters with a salinity exceeding about 10‰, the total alkalinity will arise from the ions CO_3^{2-} , HCO_3^{1-} , $\text{H}_2\text{BO}_3^{1-}$, OH^{1-} and, in a negative sense, H^+ . The effect of other ions can be neglected. Therefore, by definitions, if [] represents concentration in millimoles per liter,

$$\text{Total alkalinity} = [\text{HCO}_3]^{1-} + 2 [\text{CO}_3]^{2-} + [\text{H}_2\text{BO}_3]^{1-} + [\text{OH}]^{1-} - [\text{H}]^+$$

and

$$\text{Carbonate alkalinity} = [\text{HCO}_3]^{1-} + 2 [\text{CO}_3]^{2-},$$

whence:

$$\text{Carbonate alkalinity} = \text{total alkalinity} - [\text{H}_2\text{BO}_3]^{1-} - [\text{OH}]^{1-} + [\text{H}]^+.$$

The terms $[\text{OH}]^{1-}$ and $[\text{H}]^+$ may be neglected in the pH range 5.3–8.7. The term $[\text{H}_2\text{BO}_3]^{1-}$ may only be neglected at pH values less than 7.3 which will be rarely, if ever, encountered.

The entire carbonate "balance" in a sample of sea water can be evaluated from a knowledge of the total alkalinity and pH, provided we also know the dissociation constants of carbonic acid and boric acid in sea water of various salinities and temperatures.

The relevant data for correcting laboratory-measured pH values to give results

at *in situ* depths and temperatures and for calculating concentrations of the various carbonate species have been published (Buch and Gripenberg, *J. Conseil, Conseil Perm. Intern. Exploration Mer*, 7: 233, 1932; Buch and Nynäs, *Acta. Acad. Åboensis Math. Phys.*, 12:(3), 1939; Buch, *Havsforskn. Inst. Skr., Helsingf.*, (151), 1951). An excellent account is given by Harvey, drawing from these sources, and is to be found in his book *The Chemistry and Fertility of Sea Waters* (Cambridge University Press, 1957). The following presentation stems largely from this source but the *pH* range for some tables has been extended and we have also used more recent values for the second dissociation constant of carbonic acid. These values obtained by Dr John Lyman (Ph.D. Thesis, University of California, Los Angeles, 1957), differ significantly from the Buch values and led us to recompute some tables.

The corrections made for the presence of boric acid are based on the assumption that free boric acid is always present in sea water at a constant ratio to the chlorinity. This is not necessarily the case, especially in some inshore waters, as a variable amount of the boron may be tied up as organic complexes of differing buffering powers (e.g. Gast and Thompson, *Anal. Chem.*, 30: 1549, 1958) but the errors in carbonate calculations thus incurred are probably rarely important as long as the *pH* of a sample is less than 8.25.

The method for determining total alkalinity that is described here is taken from Anderson and Robinson (*Ind. Eng. Chem. [Anal. Edition]* 18: 767, 1946) and is sufficiently precise for most purposes. The method acts as a check of the specific alkalinity. As the latter is near 0.123 in most sea areas it is only necessary to make alkalinity measurements on samples taken at great depths or at inshore locations where there is marked land drainage or where active carbonate precipitation is suspected. If changes of specific alkalinity are required as a delicate indicator of differing water masses or of biological activity the Anderson–Robinson technique is not sufficiently precise and very careful direct titration experiments are essential (a good example is given by Cooper, *J. Marine Biol. Assoc. U.K.*, 19: 747, 1934).

For *pH* measurements to have much value in such a buffered medium as sea water they must be carried out with great care using internationally accepted standard buffers as reference points on a glass-electrode *pH* scale.

The treatment below is divided into two main subdivisions, I.4.I. and I.4.II. In the first, we describe the experimental details for the determination of *pH* and total alkalinity. In the second, we describe the calculations necessary for the full evaluation of the carbon dioxide system.

1.4.1. DETERMINATION OF EXPERIMENTAL QUANTITIES

1. pH DETERMINATION

A. CAPABILITIES

Range: pH 7.3–8.6

PRECISION

The equipment and conditions that can be used are so varied that no general statement of precision can be made. If the *pH* is used as a general indicator of water masses and water structure a precision of ± 0.03 unit is probably sufficient and should be easily obtainable.

For measurements designed to be used in the calculation of the total carbon dioxide content of sea water a precision of ± 0.02 unit should be attempted and can be obtained under sea-going conditions if care is taken.

For measurements designed to be used in the calculation of the relative amounts of the various forms of carbon dioxide (CO_2^- , HCO_3^{2-} , and free CO_2) the highest possible precision is required in *pH* measurement. Ideally a precision of ± 0.005 unit should be attempted but under most conditions it is doubtful whether better than ± 0.01 can be achieved and then the greatest care in sampling and standardization is required.

B. OUTLINE OF METHOD

The *pH* of a sample is measured by a glass electrode and electrometer-type *pH* meter after taking certain precautions in sampling and standardization. The *pH* is measured at laboratory temperature and pressure and the *pH* of the sea water *in situ* is derived by calculations involving a knowledge of the temperature and pressure of the sample when taken.

C. SPECIAL APPARATUS AND EQUIPMENT

Normally a Beckman Model G *pH* meter, or an instrument of similar specification, should be employed with "wide range" (-5 to 80 C, *pH* 0–11) glass electrodes and saturated calomel half-cell electrodes. Automatic reading instruments may be satisfactory for shipboard use, where a precision of about ± 0.03 unit is acceptable. A high-amplification *pH* meter such as the Beckman G.S. meter should be used for the most refined work, as in tracing marine photosynthesis, respiration, etc., where *pH* changes of 0.01 unit or less may be significant. Wide-mouth screw-capped 50-ml polyethylene bottles are needed, one for each sample.

D. SAMPLING PROCEDURE AND SAMPLE STORAGE

Samples must be warmed to laboratory temperature before measurement and this should occur with a minimum exchange of atmospheric and dissolved carbon dioxide. In no circumstances must the delay in measuring the *pH* exceed about 2 hr. The sample should be taken from reversing bottles immediately after the oxygen sample by filling a 50-ml wide-mouth (27 mm or more in diameter) polyethylene bottle to the brim and closing it at once with a tight-fitting screw cap. Store in the dark at low temperature until just before the analysis is commenced.

If thin probe-type electrodes are available, which may be inserted in an opening

of 12–15 mm diam, the samples may be collected in a 30- or 50-ml polyethylene narrow-mouth screw-capped bottles, filled to the brim.

E. SPECIAL REAGENTS REQUIRED

STANDARD BUFFER

0.025 M KH_2PO_4 + 0.025 M Na_2HPO_4 (pH 6.87 at 20–25 C).

Dissolve 34.0 g of potassium dihydrogen phosphate (monobasic), KH_2PO_4 and 35.5 g of anhydrous disodium hydrogen phosphate (dibasic), Na_2HPO_4 , in distilled water and make the volume to 1000 ml in a measuring flask. Store in a tightly stoppered glass bottle.

Dilute 100 ml of this solution to 1000 ml with distilled water for use. The dilute solution should be stored in polyethylene. It is stable for a few weeks if evaporation is prevented and is best preserved by a few drops of chloroform. It should be discarded if bacterial growth become apparent.

F. EXPERIMENTAL

Measure the temperature of the buffer solution (*see* Sect. E) to the nearest 1 C, adjusting it, if necessary, so that the temperature lies between 20 and 25 C. Set the temperature compensator of the pH meter to this temperature and the pH to read 6.87, then standardize the instrument according to the maker's instructions, allowing 5 min for the electrodes to reach equilibrium. The pH of the buffer is constant in the temperature range 20–25 C and a standardization at pH 6.87 will be effective for the pH range 7–9. With a satisfactory meter and electrodes the standardization need be repeated only once a day.

Place the samples in a thermostatically controlled water bath until they attain a temperature *within* ± 3 C of the temperature at which the pH meter was standardized. (If the temperatures of samples and buffer differ by more than 3 C, errors become appreciable as the temperature compensator on the pH meter does *not* effect a complete temperature correction.)

If the electrodes have just been immersed in buffer they should be washed with water and *gently* dried with a little paper tissue, otherwise the electrodes are transferred from one solution to another without rinsing or wiping. Remove the cap from the sample bottle and immerse the glass and calomel electrodes well down into the bottle. Measure the pH and temperature of the sample after between 3 and 5 min immersion, adjusting the temperature compensator of the meter to the solution temperature just before a final reading is taken. The solution should be *gently* swirled once or twice to assist the electrodes in reaching equilibrium.

Note the pH and the temperature of the solution, pH_m and t_m , respectively. If the sample was initially at a temperature of t C when taken at a depth d meters, its correct pH, *in situ*, is given by the expression:

$$pH_s = pH_m - \alpha(t - t_m)$$

neglecting pressure effects. The latter are rarely significant but the pH at depth d meters, pH_d , is related to the pH at the surface, pH_s , by the expression:

$$pH_a = pH_s - \beta d$$

Values for the coefficients α and β are given in Part VI, Tables III and IV. The temperature correction should always be applied before making the calculations described later. The pressure variation is negligible for samples taken above about 500 m.

2. TOTAL ALKALINITY DETERMINATION

A. CAPABILITIES

Range: 0.5–2.8 milliequivalents per liter

PRECISION

The correct value lies in the range:

Mean of n determinations $\pm 0.022/n^3$ milliequivalents total alkalinity per liter.

Reject duplicate determinations if the pH values after acidification (*see* Sect. F and Note 2, Sect. G) differ by more than about 0.03.

B. OUTLINE OF METHOD

A portion (100 ml) of the seawater sample is mixed with 25 ml of exactly 0.0100 N hydrochloric acid. The pH of the resulting solution is measured. The standard acid in excess of that required to titrate the sample to the carbon dioxide inflection point is computed from a knowledge of this pH and an empirical factor. This excess acid is then subtracted from 2.500 milliequivalents per liter (the amount initially added by 25 ml of 0.01 N acid) and the total alkalinity of the sample is thus evaluated.

C. SPECIAL APPARATUS AND EQUIPMENT

A Beckman Model G pH meter, or an instrument of similar specification, should be employed with "wide-range" (-5 to 80 C, pH 0–11) glass electrodes and saturated calomel half-cell electrodes. Automatic reading instruments are only acceptable if used with the greatest possible precision (± 0.025 unit or better).

Also needed are 200-ml wide-mouth screw-capped polyethylene bottles, one for each sample.

D. SAMPLING PROCEDURE AND SAMPLE STORAGE

No great problems are encountered in sampling and storage. The samples are best stored in plastic or in glass bottles that have been soaked for several days in 1% hydrochloric acid and then rinsed thoroughly in distilled water before they are dried. Evaporation must be prevented by tightly stoppering the containers and it is best to carry out the determinations on the same day as the samples are taken by pipetting the seawater sample directly into standard acid (*see* Sect. F). However, careful storage of the samples for several weeks, as for salinity (*see* Part I.1), is permissible.

E. SPECIAL REAGENTS REQUIRED

1. STANDARD 0.01000 N HYDROCHLORIC ACID

Prepare by standardizing hydrochloric acid of a slightly greater concentration

and then adjusting the volume by the addition of a calculated amount of distilled water to bring the normality to precisely 0.1000 N. Dilute this solution exactly ten-fold, by a pipette and measuring flask, before use.

2. STANDARD BUFFER

0.05 M potassium hydrogen phthalate (pH 4.00 at 20–25 C).

Dissolve 10.21 g of analytical reagent quality (primary buffer-standard specification) potassium hydrogen phthalate, $KHC_8H_4O_4$, in distilled water and make the volume to 1000 ml in a measuring flask. Store in a glass bottle. The solution is stable almost indefinitely in the absence of evaporation. The formation of a slight turbidity introduces no error.

F. EXPERIMENTAL

Pipette 25.00 ml of standard 0.01000 N hydrochloric acid into a dry 200-ml polyethylene wide-mouth screw-cap bottle. Add from a pipette 100.0 ml of seawater sample. Stopper the bottle and mix the solutions thoroughly. Warm the solution to room temperature and measure the pH exactly as described in the preceding method, except that the phthalate buffer is used to standardize the pH meter, instead of the phosphate buffer. The pH of the phthalate buffer between 20 and 25 C is taken as 4.00.

G. CALCULATIONS

1. Find the value of a_H corresponding to the measured pH value from Table V. The pH must lie between 2.8 and 4.0. (As the pH is measured in the range 20–25 C no temperature correction is necessary.)

2. Find the value of f from Table VI, according to the salinity and pH value.

3. Calculate the total alkalinity from the equation

$$\text{Total alkalinity} = 2.500 - (1250 a_H/f)$$

Note 1: For chlorinity values between 12 and 18‰ ($S = 22\text{--}33\%$) and final pH values between 3.0 and 3.9 the total alkalinity may be read directly from Table VII without incurring appreciable errors.

Note 2: If the final pH is greater than 4.0 remove the electrodes, but do not wash them, and pipette 5.00 ml of 0.01000N acid into the bottle. Mix the solution and again measure the pH . Calculate a_H and f as above and substitute in the equation:

$$\text{Total alkalinity} = 3.000 - (1300 a_H/f)$$

This procedure will be necessary with most ocean waters of S greater than 33‰.

14.II. CALCULATIONS AND USE OF TABLES

Note: Most of the data in Tables IX and X are rounded off to two significant figures and are reported only for the comparatively large pH intervals of 0.1 pH unit. For use these tables should be made the basis of graphical interpolations.

1. CALCULATION OF THE CARBONATE ALKALINITY

Required: Total alkalinity, chlorinity or salinity, initial temperature, pH, and the temperature at which the pH was measured.

- Calculate the initial pH of the water from Table III.
- Look up the quantity A (milliequivalents per liter) in Table VIII.

$$\text{Carbonate alkalinity} = \text{total alkalinity} - A \text{ (milliequivalents/liter).}$$

2. CALCULATION OF TOTAL CARBON DIOXIDE CONTENT (ALL FORMS)

Required: Total alkalinity, chlorinity or salinity, initial temperature, pH, and the temperature at which the pH was measured.

- Calculate the initial pH of the water from Table III.
- Calculate the carbonate alkalinity as in 1 above.
- Look up the factor F_T in Table IX.

$$\text{Total CO}_2 \text{ content} = \text{carbonate alkalinity} \times F_T \text{ (millimoles/liter).}$$

3. CALCULATION OF THE PARTIAL PRESSURE AND CONCENTRATION OF CARBON DIOXIDE

Note: In the equilibrium

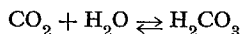

for sea water, only 1% or less of the total carbon dioxide is in the form of carbonic acid. This equilibrium is attained relatively slowly in sea water. In living tissue the enzyme *carbonic anhydrase* greatly accelerates the combination of water and carbon dioxide gas.

Required: Carbonate alkalinity (*see 1 above*), chlorinity or salinity, initial temperature, pH, and the temperature at which the pH was measured.

- Calculate the initial pH of the water from Table III.
- Look up the factor F_p in Table X.
- Calculate the partial pressure of carbon dioxide, (P_{CO_2}), from the expression:

$$P_{\text{CO}_2} = \text{carbonate alkalinity} \times F_p \text{ (atmospheres).}$$

- Look up the solubility of carbon dioxide in unbuffered sea water of the appropriate salinity and temperature in Table XI. If γ is this value in millimoles per liter, the following holds.

$$\text{Concentration of dissolved CO}_2 = P_{\text{CO}_2} \times \gamma \text{ (millimoles/liter).}$$

4. CALCULATION OF BICARBONATE ION CONCENTRATION $[\text{HCO}_3]^{1-}$

Required: Carbonate alkalinity, chlorinity or salinity, initial temperature, pH, and the temperature at which the pH was measured, the dissociation constant K , where K is defined as

$$\frac{a_H \times [\text{CO}_3]^{2-}}{[\text{HCO}_3]^{1-}}$$

where a_H is measured by a glass electrode. Values for K as a function of temperature (*in situ*) and chlorinity (or salinity) are collected in Table XII.

a. Calculate the initial pH of the water from Table III.

b. Look up the corresponding a_H value from Table V.

Bicarbonate concentration:

$$[\text{HCO}_3]^{1-} = \text{carbonate alkalinity} \times \left[\frac{a_H}{a_H + 2K} \right] \text{ as millimoles/liter.}$$

5. CALCULATION OF CARBONATE ION CONCENTRATION $[\text{CO}_3]^{2-}$

Required: Carbonate alkalinity, chlorinity or salinity, initial temperature, pH , and the temperature at which the pH was measured, the dissociation constant K .

a. Calculate the initial pH of the water from Table III.

b. Look up the corresponding a_H value in Table V.

Carbonate concentration:

$$[\text{CO}_3]^{2-} = \text{carbonate alkalinity} \times \left[\frac{K}{a_H + 2K} \right] \text{ as millimoles/liter.}$$

If the pH exceeds 8.1:

$$[\text{CO}_3]^{2-} = \text{total carbon dioxide content} - [\text{HCO}_3]^{1-},$$

where the total carbon dioxide is evaluated as in calculation 2 above.

I.5. DIRECT DETERMINATION OF TOTAL CARBON DIOXIDE

INTRODUCTION

This procedure is a simple modification of the Van Slyke gas analysis method, adapted for use with a 5-ml sample. Corrections have been evaluated assuming that 3.7% of the carbon dioxide redissolves during the compression of stripped gas to a volume of 0.5 ml, that the volume of carbon dioxide remaining in sea water under reduced pressure is as given by Buch (*see Harvey's The Chemistry and Fertility of Sea Water*, Cambridge University Press, 1957), that a coefficient of expansion of 1.00384 per C allows for the change of both gas and mercury volumes with temperature and that the molar value of carbon dioxide is 22.265 liters. The method is particularly suited for the measurement of the relatively small changes in the total carbon dioxide content of a seawater sample that occur as a result of biological processes. Any slight absolute error in the determination is then of minor significance.

METHOD

A. CAPABILITIES

The coefficient of variation for determinations in sea water of about 30‰ salinity is approximately 0.25%, that is, the correct value will be in the range:

Mean of n determinations $\pm 0.5\% / n^{\frac{1}{2}}$ of the mean amount found.

Reject a determination if the duplicate values for P_1 (*see later*) vary by more than 1–2 mm of mercury or if the duplicate values for P_2 differ by more than 1 mm. Reject duplicate determinations if values for $(P_1 - P_2) \times F$ differ by more than 0.75% of the mean.

B. OUTLINE OF METHOD

A 5-ml sample of sea water is acidified with a little acid and the gases, including the carbon dioxide from decomposed carbonate, are liberated by applying a partial vacuum in a Van Slyke gas analyzer. The gases are compressed to a volume of 0.5 ml and the pressure required to do this is measured in millimeters of mercury. The carbon dioxide is then absorbed by alkali and the pressure again noted when the remaining gases (N_2 and O_2) are compressed to 0.5 ml. The total carbon dioxide in the sample is calculated from the difference in the two pressures, making suitable corrections for the temperature and salinity of the sample.

C. SPECIAL APPARATUS AND EQUIPMENT

1. 5-ml special Van Slyke pipette. The end part of the pipette should have a sleeve of thin surgical rubber tubing which overlaps the tip by about 0.5–1 mm, enabling a good seal to be made in the filling cup (*see later*). The pipette is calibrated to deliver 5 ml between two etched marks. The volume of each pipette used should be determined exactly by weighing the volume of water delivered and reported to the nearest 0.005 ml.

2. Van Slyke gas analysis apparatus, constant volume type, with 50-, 2-, and

0.5-ml graduations on the gas chamber and a manometer graduated in units of 1 mm. The gas chamber must be water jacketed with a thermometer in the jacket reading to the nearest 1 C from 15 to 30 C. Mechanical shaking is highly desirable. A suitable model may be obtained from Frederick G. Keyes Inc., Cambridge, Massachusetts, USA. The following instructions apply directly to this model.

3. Only clean, redistilled mercury should be used and all taps must be carefully greased with stopcock grease. Leaks are to be suspected if P_1 values (*see later*) do not duplicate to within 2 mm or if they change by more than 1 mm in the first 2–3 min after compression of the gases.

4. The analyst must familiarize himself with the Van Slyke equipment, its maintenance and servicing, etc., by experience. Further details and description are given in the papers by Van Slyke and Neill (*J. Biol. Chem.*, 61: 297 and 532, 1924), Harlington and Van Slyke (*J. Biol. Chem.*, 73: 121, 1927), Van Slyke and Sendroy (*J. Biol. Chem.*, 73: 127, 1927), and in instructions provided by the instrument manufacturers.

The special working details given here refer to 2 taps:

T_1 is the two-way tap connecting the top of the gas chamber with either the sample "cup" or the emptying tube.

T_2 is the two-way tap connecting the gas chamber and manometer with the mercury reservoir bulb. The latter should have two fixed resting positions. In position *H* the mercury in the reservoir should be above the tap T_1 ; in position *L* it should be well below the tap T_1 . In addition, there should be room to lower the mercury reservoir bulb at least 2½ feet below the apparatus so as to pull a vacuum in the gas chamber.

A small (100-ml) beaker is needed to receive used sample and waste solutions and any mercury expelled through the emptying tube.

A 1.0-ml bulb pipette for acid and a 1.0-ml graduated pipette for adding 0.2 ml sodium hydroxide solution are also needed.

D. SAMPLING PROCEDURE AND SAMPLE STORAGE

Samples must be warmed to laboratory temperature before measurement and this should occur with a minimum exchange of atmospheric and dissolved carbon dioxide. In no circumstances must the delay in measuring the carbon dioxide content exceed about 2 hr. The sample should be taken from reversing bottles immediately after the oxygen sample by filling a 50-ml polyethylene bottle to the brim and closing it at once with a tight-fitting screw cap. Store in the dark at low temperature until just before the analysis is commenced.

E. SPECIAL REAGENTS

1. SULPHURIC ACID REAGENT

Add 10 ml of concentrated analytical reagent-grade sulphuric acid to 1000 ml of distilled water.

2. SODIUM HYDROXIDE REAGENT

Boil 100 ml of distilled water for 2–3 min to expel most of the dissolved gases. Cool rapidly and add 20 g of pellet-form analytical reagent-quality sodium

hydroxide. Again cool the solution rapidly and store it in a small *tightly stoppered* polyethylene bottle. The solution is stable for many months provided that air is excluded.

3. MERCURY

A small dropping bottle of pure mercury with a "pen-filler" stopper is required.

F. EXPERIMENTAL

PROCEDURE

Note: Rinse the gas chamber *immediately* before and after each determination by adding the cupful (5–6 ml) of sulphuric acid reagent to the gas chamber, pulling the mercury in the gas chamber down to just below the 50-ml graduation and up again and finally expelling the solution through the emptying tube. Fill the emptying tube with mercury and turn T_1 to fill the capillary into the cup with mercury before commencing an analysis or when the equipment is to be "shut down."

1. With the reservoir at L , T_2 open and T_1 shut, add 1.0 ml of acid to the cup. Open T_1 carefully and let the acid into the chamber until the level in the cup is to the top of the capillary (Note a). Add 2–3 drops of mercury to the cup with the pen filler. The mercury should lie on top of the acid in the capillary. Open T_1 carefully so that the acid in the capillary enters the gas chamber and mercury is drawn in to fill the capillary and leave only a small drop in the cup (Note b). Close T_1 and check that mercury is in both capillaries (to the emptying tube and cup; *see* Note c).

2. With T_2 open, lower the reservoir until the mercury in the gas chamber is pulled down to the bottom of the bulb just above the 50-ml graduation. Close T_2 and put the reservoir into position H . Shake the gas chamber for 1 min (Notes d and e).

3. Open T_2 a little until the mercury reaches the top of the manometer (Note f) and then open the tap fully. Open T_1 to the cup very carefully so as to expel the small bubble of gas plus the minimum amount of acid. Reintroduce the expelled acid and make a fresh mercury seal as described in 1 above. Add about 1 ml of excess mercury to the cup and then thoroughly dry the cup and mercury surface with a spill of absorbent paper tissue. Have the reservoir at L and tap T_2 open.

4. Rinse the Van Slyke pipette by filling and emptying once with sample. Fill the pipette and lower the solution level to the top mark. Wipe the pipette sides and tip with tissue and introduce the pipette into the cup with the end pushed snugly into the top of the cup capillary and the rubber tube overlap making a cushion and seal. Open the pipette tap and by careful manipulation of T_1 suck the sample out of the Van Slyke pipette until the bottom mark is reached, then close T_1 . The pipette should be firmly held but not pushed down unduly hard during all this operation. Close the pipette tap. Open T_1 slightly. Remove the pipette. The sample in the capillary and then mercury will *rapidly* enter the gas chamber. Close T_1 before all the mercury has entered and then manipulate T_1 so that all the remaining mercury, except for a small bead above the capillary, is in the gas chamber. Dry the cup with tissue (Note g).

5. Lower the reservoir until the mercury is near the bottom of the gas chamber and finally manipulate T_2 until the top of the mercury meniscus is just at the 50-ml

graduation. Close T_2 and fix the reservoir in position L . Shake the chamber for 3 min (Notes e and h).

6. Open T_2 so that mercury flows into the gas chamber quite rapidly at first and then progressively more slowly until the bottom of the *water* meniscus is just level with the 0.5-ml graduation (*important to read Note i*). Tap T_2 is now closed. Read the pressure on the manometer without delay to the nearest 0.5 mm. Lower the reservoir again and open tap T_2 and repeat the operations of 5 and 6 except for the shaking which need only be for 1 instead of 3 min. The two manometer readings should be within 2 and preferably 1 mm of each other and steady; if not, repeat a third time. Take the mean reading P_1 in millimeters and note the temperature of the jacket around the gas chamber to the nearest 0.5 C. P_1 will normally be in the range 500–650 mm.

7. Add 0.20 ml sodium hydroxide solution to the cup. (Rinse the pipette with water immediately afterwards to prevent attack by the strong alkali.) Open T_1 and carefully introduce the alkali into the gas chamber except for the solution in the capillary. Add 2–3 drops of mercury to the cup to rest on the sodium hydroxide solution and open T_1 so that the remaining alkali is drawn into the gas chamber together with enough mercury to form a tap-capillary seal (Notes a and b).

8. Lower and raise the mercury throughout the length of the gas chamber rather rapidly by lowering and raising the reservoir with T_2 fully open and finally adjust the mercury to the 50-ml graduation as described in 5 above (Note j). Shake the chamber for 1 min (Note k) with T_2 closed and the reservoir in position L .

9. Compress the gases to exactly 0.5 ml and take the pressure reading P_2 exactly as described in 6 above. P_2 will normally be in the range 250–300 mm. A duplicate reading may be taken but is generally unnecessary if the equipment is functioning satisfactorily (Note j). Again note the temperature of the water jacket. It should be within 0.5 C of the value measured in 6 above. If not, record a mean.

10. Calculate the total carbon dioxide content of the sample from ($P_1 - P_2$) using Table XIII (Part VI) and interpolating F values to the nearest 0.5 C and to the true salinity where necessary. An approximately linear interpolation is adequate, and some extrapolation in the salinity range (at least to 20‰ and 38‰) is probably justified.

NOTES

(a) If liquid is taken into the capillary part of the cup at this stage a bubble of air will be trapped in it by the mercury and this is difficult to remove.

(b) If more than a small bead of mercury is left in the cup at this stage, it may be spilled when the gas chamber is shaken.

(c) The most common site of leakage in the Van Slyke apparatus is through tap T_1 when a vacuum is pulled on the gas chamber. This is generally prevented altogether if mercury is always present in the cup, the emptying tube and in the two tap capillaries.

(d) This operation is designed to remove dissolved gasses from the one ml of acid.

(e) The rate of shaking is somewhat arbitrary but should be as vigorous as practicable, that is, at least two oscillations a second with the mechanically shaken apparatus.

(f) During this operation the mercury rises into the manometer and care should be taken to see that this rise is not so rapid that the mercury hits the top of the manometer with sufficient force to break it.

(g) The precise addition of sample by the Van Slyke pipette is a critical stage of this analysis. The necessary high precision requires considerable practice but is not then difficult to achieve.

(h) Vigorous shaking for 3 min is about optimal. With less time the gases do not come into equilibrium. Prolonged shaking under partial vacuum increases the risk of leakage. The 3 min should be *timed* within 10 sec.

(i) The method of compressing gases to the 0.5-ml mark is the second critical stage of the method. The procedure should be rapid initially and then the rise of mercury should be checked so that when T_2 is finally closed there is *no oscillation* of the fluid. The total time taken for this step should not be less than 30 sec or more than 45 sec and the analyst should practice until a smooth compression within this time-limit is achieved. The value of 3.7% for resolution of CO_2 (see formula in Table) depends on this operation being performed as described. Finally, the precision of the method depends critically on the volume of compressed gases and the water meniscus must be exactly at the 0.5-ml graduation. Any error in this volume will show as a proportional error in the final determination. This is particularly the case when measuring the P_1 value when 80% of the gas is CO_2 . The glass of the gas chamber should be completely grease-free so that a good meniscus is obtained, and the setting should be made with the aid of a magnifying lens such as is used for precise burette readings.

(j) The carbon dioxide in the stripped gases is absorbed fairly rapidly but moving the liquid up and down the chamber assists in complete solution. Magnesium salts, etc., precipitate at this stage and may distort the meniscus and give difficulty when reading P_2 . This is most noticeable if a duplicate reading of P_2 is made and, on balance, it is probably of little value to make two such readings unless the first is spoilt. Fortunately, the setting to precisely 0.5 ml is rather less critical when measuring P_2 as the partial pressure of the remaining gases is much less than P_1 .

(k) One minute of shaking is sufficient at this stage as it is only necessary to restrip small amounts of oxygen and nitrogen dissolved during the measurement of P_1 .

G. DETERMINATION OF BLANK

In this "difference" type of measurement there is no blank in the normal sense. Equipment blanks (largely slight leakages, traces of gas in reagents, etc.) have been recommended but it is doubtful if these merit the trouble and may give more errors than they eliminate.

H. CALIBRATION

This is given by the factors in Table XIII. The values for total CO_2 obtained by this method do not agree too well with results obtained by the pH-alkalinity method, being several per cent less. The discrepancy increases at higher pH values. It seems reasonable to assume that errors exist in both procedures but there is evidence that the pH method gives a progressively greater error (high) as the pH increases. The Van Slyke technique is capable of much greater precision than the pH-alkalinity method and is well suited for measuring small *changes* in CO_2 content of various seawater samples.



I.6. DETERMINATION OF SULPHIDE

INTRODUCTION

Sulphide is found in anoxic sea water and may be present in small amounts even when there is a low concentration of oxygen. The method described here, depending on the formation of Lauth's violet from *p*-phenylenediamine, is a simple application to sea water of a well established colorimetric method for sulphide. Other substituted *p*-phenylenediamines have been used but there is little indication that one is better than another. A critical study by Kato, Takei and Ogasawara (*Technol. Rept., Tohoku Univ.*, 19: 85, 1954) indicates that the unsubstituted amine is probably best. Sulphur is converted quantitatively into a highly coloured dye-stuff and the method is nearly as sensitive as theoretically possible and suitable for all concentrations of sulphide to be expected in the sea.

METHOD

A. CAPABILITIES

Range: 0.2–400 μg-at/liter

1. PRECISION AT THE 25 μG-AT/LITER LEVEL

The correct value lies in the range:

Mean of *n* determinations $\pm 0.3/n^{\frac{1}{2}}$ μg-at/liter (using 1-cm cells).

2. LIMIT OF DETECTION

The smallest amount of sulphide that can be detected with certainty is about 0.2 μg-at/liter (using 10-cm cells).

B. OUTLINE OF METHOD

The acidified sample is allowed to react with *p*-phenylenediamine and ferric chloride. A complex oxidation and substitution takes place resulting in the quantitative incorporation of any sulphide-sulphur present into a heterocyclic sulphur-containing dye called Lauth's violet. The extinction of solutions are measured, before or after dilution, using 1- or 10-cm cells.

C. SPECIAL APPARATUS AND EQUIPMENT

A 50-ml capacity stoppered graduated glass measuring cylinder is needed for each sulphide determination.

D. SAMPLING PROCEDURE AND SAMPLE STORAGE

As any sulphide in sea water is rapidly oxidized, similar precautions are required to those described in I.3.D. The samples should be collected in plastic or tin-lined bottles (not brass) and put into bottles as described in I.3.D, except that 100-ml glass-stoppered reagent bottles are sufficient. BOD bottles are not necessary. Samples for sulphide should be drawn without delay immediately after samples for oxygen. Analyses should be commenced within an hour of taking the samples which should be stored in the meantime in a cool dark place.

E. SPECIAL REAGENTS

1. *p*-PHENYLENEDIAMINE HYDROCHLORIDE

The laboratory reagent should preferably be recrystallized once from alcohol. The recrystallized material is stable for many months if stored dry in a stoppered bottle. Dissolve 1.0 g of recrystallized salt in a mixture of 100 ml of concentrated hydrochloric acid (sp gr 1.18) and 400 ml of distilled water. This solution, in a stoppered glass bottle, may be kept for 2–3 weeks.

2. FERRIC CHLORIDE SOLUTION

Dissolve 10 g of analytical quality anhydrous ferric chloride, FeCl_3 , in 100 ml of concentrated hydrochloric acid (sp gr 1.18) and then add 400 ml of distilled water. This solution may be stored in a glass bottle and is stable indefinitely.

F. EXPERIMENTAL

PROCEDURE

1. The samples, stored in completely filled glass bottles, should be between 15 and 30 C. Pour 50 ml, with minimum aeration, into a dry 50-ml measuring cylinder fitted with a stopper. Stopper the cylinder immediately (Note *a*).
2. Without delay (Note *b*) add 5.0 ml of *p*-phenylenediamine hydrochloride solution from an automatic pipette, stopper the cylinder and invert it twice.
3. Not more than 2 min later add 1.0 ml of ferric chloride solution and invert twice. Within the next 1–2 min invert the cylinder once or twice more (Note *c*).
4. Allow the solution to stand for 10 min but preferably no more than 20 min (Note *d*). Measure the extinction of the solution against the *blank* (not distilled water) in a 10-cm or 1-cm cell (Note *d*). If the extinction exceeds about 1.0 in a 1-cm cell transfer 5.0 ml with a pipette to another clean 50-ml stoppered measuring cylinder, dilute to 50 ml with distilled water and measure the extinction in a 1-cm cell against a blank similarly diluted (Note *e*). A wavelength of 6000 Å should be used with a spectrophotometer (blue-sensitive photocell). If a filter-type absorptiometer is used choose a filter having a maximum transmission near to 6000 Å. Unless adjacent samples are known to have extinction values within about 25% of each other the absorptiometer cell should be rinsed with each new solution before filling.
5. Calculate the sulphide concentration in microgram-atoms of sulphur per liter ($\mu\text{g-at S/liter}$) from the expression:

$$\mu\text{g-at S/liter} = \text{extinction} \times F$$

where F is a factor obtained as described in Section H, below, for a 1-cm cell. If a 10-cm cell is used multiply the value for F by 0.1. If a dilution is made multiply the factor by 10.

$$\text{ml}(\text{H}_2\text{S})_{(\text{NTP})}/\text{liter} = 0.0224 \times \mu\text{g-at S/liter}$$

NOTES

(*a*) There is little temperature effect but if solutions are colder than 10–15 C rather more than 10 min may be necessary for full colour development (*see* F. 4) and if temperatures exceed 25–30 C the dangers of sulphide losses (Note *c*) increase. There is no pronounced salt effect

with this method but the rate of change of blank extinction values depends somewhat on salt concentration and it is best to prepare standards and blanks with surface (oxygenated and hence sulphide-free) sea water.

(b) After transferring solutions to the 50-ml cylinders, even with as little oxygenation as possible, sulphide oxidation commences and can be detected even after 5–10 min. The analysis should not be delayed more than a few minutes.

(c) After the *p*-phenylenediamine solution is added oxidation rates increase and, for this reason, the analysis must not be delayed. Some hydrogen sulphide gas will collect in the air space above the liquid. Cylinders (50-ml), which are generally nearly filled by 55 ml of liquid, are used deliberately to keep the air space to a minimum. When the ferric chloride is added both reagents are mutually destructive and no longer react after about 5 min. During this time, however, traces of sulphide in the air over solutions can be reabsorbed and allowed to react. For this reason, the contents of the cylinder should be gently mixed once or twice more in the first few minutes. Large air spaces must be avoided and cylinders must always be stoppered or otherwise losses of hydrogen sulphide can be severe.

(d) The production of Lauth's violet should be complete within 10 min and solutions, thereafter, are stable for days. The extinctions slowly increase but, as this increase is the same in both samples and blanks and is reproducible, this is not serious. One should, however, make measurements as soon as practicable, especially when determining quantities with a 10-cm cell. Blank solutions must be prepared within 1 or 2 min of samples.

(e) The solutions can be diluted with distilled water *after colour* development and give a strictly proportional decrease of extinction. The concentrations of amine and ferric chloride recommended here are sufficient for the reaction of a maximum of 400 $\mu\text{g-at S/liter}$.

G. DETERMINATION OF BLANK

The amount of sulphide in ordinary oxygenated surface sea water may be considered negligible. Use filtered surface sea water and carry out the method exactly as described in Section F, paragraphs 1–3 inclusive. One blank is sufficient for each batch of samples. Reagents should be added to the blank within 1 or 2 min of the time at which they are added to samples. Samples are measured against this blank, which is put in the spectrophotometer cell normally filled with water. If pure *p*-phenylenediamine is used the value of the blank extinction after 20 min *against water* should not exceed 0.5 in a 10-cm cell and should preferably be less than 0.25.

H. CALIBRATION

Note: The most difficult part of this method is in obtaining a good value for *F*, as dilute sulphide solutions are very unstable in air, but once *F* is found it rarely requires redetermination if a spectrophotometer is used.

1. STANDARD SULPHIDE SOLUTION

Fill a small glass bottle of known volume (100–150 ml) with distilled water and remove dissolved oxygen by bubbling nitrogen gas vigorously for at least 30 min. Add sodium sulphide, $\text{Na}_2\text{S}\cdot 9\text{H}_2\text{O}$, weighing only the driest and cleanest looking crystals, to the extent of 1.5 g for each 100 ml of water. Stopper the bottle so that no air is trapped and invert it several times to dissolve all the sulphide. Prepare this solution on the same day that the method is to be standardized.

Fill a 250-ml measuring flask to the top with distilled water and remove oxygen by passing nitrogen gas for several hours. Add 1–5 mg of anhydrous sodium carbonate to ensure that the water is slightly alkaline. Pipette in 5.0 ml of stock sulphide. The final volume need not be exactly 250 ml but liquid should now nearly fill the

measuring flask. Invert several times to mix. This is the working sulphide standard and it must be assayed and used to standardize the method as soon as possible (within 15 min of preparation).

2. APPROXIMATELY 0.01 N THIOSULPHATE SOLUTION

Prepare and standardize against iodate as described in I.3,H.

3. APPROXIMATELY 0.01 N IODINE SOLUTION

Dissolve 0.64 g analytical reagent quality iodine, I_2 , in a little water containing 3–4 g of potassium iodide, KI. When the iodine has dissolved dilute the solution to 500 ml with distilled water.

4. STANDARDIZATION OF SULPHIDE

This is carried out within minutes of preparing the standards for colorimetry (*see below*). Take four 150-ml Erlenmeyer flasks and add to each about 10 ml of water and 1–2 g of potassium iodide (from the end of a spatula). Pipette into each flask 10.0 ml of 0.01 N iodine solution. Add 2–3 drops (not critical but do not exceed 0.5 ml) of concentrated hydrochloric acid to each flask. Into two of the flasks pipette 25.0 ml of the dilute sulphide standard and into the other two add about 25 ml of distilled water. Set all flasks aside in a cool place whilst the colorimetric standardization is commenced (*below*) and then titrate the contents of the flasks with thiosulphate using starch indicator.

If A ml is the mean of the titers of the two solutions with no added sulphide and B ml the mean of the other two titers (the individual titers constituting a duplicate should agree to within 0.05 ml) calculate a quantity Q given by the expression:

$$Q = 4 \times f \times (A - B)$$

where f is the thiosulphate factor determined as described in I.3,H. A little colloidal sulphur will be formed in the flasks containing sulphide but this does not affect the starch end point.

5. PROCEDURE

Prepare in advance five 50-ml cylinders, four of which contain 49 ml, and the other 50 ml, of filtered surface sea water. Immediately after taking the 25.0-ml aliquots for standardization (*above*) remove four 1.00 ml aliquots of the dilute standard with a 1.00-ml bulb pipette and add these to the four cylinders containing 49 ml of sea water. Mix by gently inverting each cylinder once. Immediately (within 1–2 min) continue the method as described in F.1–4 above. Finish the titrations described in H.4 above, whilst waiting for the colour to develop. Calculate the factor F (1 cm) from the expression:

$$F = \frac{Q}{E}$$

where E is the mean extinction of the four standards *measured against the blank* in a 1-cm cell and Q is the quantity calculated as described above. The value for F should be near to 37.

PART II. THE INORGANIC MICRONUTRIENTS IN SEA WATER

II.1. INTRODUCTORY REMARKS ON A DIFFERENTIATION OF THE VARIOUS FORMS OF PHOSPHORUS

INTRODUCTION

Before giving analytical methods for phosphorus determinations in sea water some discussion of the possible forms of phosphorus in sea water and their methods of differentiation may be useful. It is not certain that all these forms of phosphorus exist at the same time in sea water or that many of them are of great ecological importance.

DEFINITIONS

The following eight forms of phosphorus in combination will be considered. Their differentiation is based on their reactivity with molybdate, ease of hydrolysis and particle size. It is assumed that fuming perchloric acid will mineralize and hydrolyze phosphorous to orthophosphate from whatever form in which it may occur in the sea and that ultraviolet light "oxidation" will destroy all organic phosphate bonds but not affect polyphosphate linkages. As mentioned in NOTES ON APPARATUS the definition of particulate material is somewhat arbitrary. A 0.5 micron pore-size membrane filter can be used but a glass filter paper is more convenient and probably nearly as good.

<i>Symbol</i>	<i>Description</i>	<i>Determination</i>
1. I.S.R. (inorganic; soluble, and reactive)	Orthophosphate ion.	The major fraction of the result of determination II.2 on filtered sea water.
2. O.S.R. (organic, soluble, and reactive)	Phosphorus held in organic combination in solution which hydrolyzes and reacts in 5 min with acidified molybdate. There may be a few easily hydrolyzable sugar phosphates in this category. They will almost certainly be included in E.H.P. (<i>below</i>).	An unknown fraction will be determined by III.1. There is now evidence from work in lakes that this fraction could be high.
I.S.R. + O.S.R.	Soluble "reactive" phosphorus.	II.2 on filtered sea water.

<i>Symbol</i>	<i>Description</i>	<i>Determination</i>
3. O.S.U. (organic, soluble, and unreactive)	Phosphorus in solution, organically combined, which is not enzyme or acid molybdate hydrolyzable. We suspect that this is largely derived from nucleic acids and may be a major fraction of "dissolved organic phosphate," obtained by methods such as II.3.	III.2-III.1 on filtered sea water (results may be a little low if much polyphosphate is present) which is attacked by phosphomonoesterase.
4. E.H.P. (enzyme hydrolyzable phosphate)	Soluble phosphate easily hydrolyzable by the enzyme alkaline phosphomonoesterase. This will consist of most simple sugar phosphates and some small fraction of any linear inorganic polyphosphates present (but not pyro- or tripolyphosphates).	III.1.
5. P.P. (polyphosphate)	Soluble phosphorus in substances with a condensed phosphate linkage. This will comprise both inorganic and organic (ATP, etc.) polyphosphate bonds but is likely to be largely the former, especially in areas where there is pollution from detergents. Some fraction of this material may be detected by E.H.P. (<i>above</i>).	II.4 on filtered sea water.
O.S.U. + E.H.P. + P.P.	This is the "total phosphorus" of the perchlorate method.	II.3 on filtered sea water.
6. I.P.U. (inorganic, particulate, and unreactive)	Particulate phosphorus, inorganically combined, that is nonreactive to acidified molybdate for a period of 5 min. This could comprise a sizeable fraction of many phosphate-containing minerals.	No known convenient method.

<i>Symbol</i>	<i>Description</i>	<i>Determination</i>
7. O.P.U. (organic, particulate, and unreactive)	Particulate phosphorus, organically combined either in living material or detritus, that is nonreactive to acidified molybdate for a period of 5 min. A little of the phosphorus in living cells may be lost. Most "particulate phosphorus" results by methods such as IV.5 will consist largely of O.P.U. but the possibility of some I.P.U. and P.R. (<i>below</i>) being determined should not be overlooked if samples are taken near the sea floor.	No known convenient method.
I.P.U. + O.P.U.	This fraction is rarely determined.	IV.5 - (II.2 on unfiltered sea water) + (II.2 on filtered sea water)
8. P.R. (Particulate, reactive)	Inorganic and (possible but unlikely) organic phosphorus that is absorbed onto particles or is otherwise out of solution in sea water but which becomes soluble and reacts with acid molybdate in 5 min. Such material includes calcium and ferric phosphates and any phosphate from plant cells. It can be appreciable in sea water.	(II.2 on unfiltered sea water) + (II.2 on filtered sea water).
I.P.U. + O.P.U. + P.R.	Most commonly determined "particulate phosphorus." Probably mainly O.P.U. in most samples but see 7 above.	IV.5.



II.2. DETERMINATION OF PHOSPHORUS

II.2.1. DETERMINATION OF REACTIVE PHOSPHORUS

INTRODUCTION

All methods for phosphate in sea water rely on the formation of a phosphomolybdate complex and its subsequent reduction to highly coloured blue compounds. Methods using stannous chloride as a reductant at room temperature have been favoured as they are most sensitive and give less interference from easily hydrolysable organic compounds than do other techniques. There are complexities in these methods due to interference from arsenic and to concealed blanks arising from the reduction of molybdate in sea water in the absence of phosphate. An excellent program of comparative tests has been described by Jones and Spencer (*J. Marine Biol. Assoc. U.K.*, 43: 251, 1963).

The procedure given below is taken from the recent publication of Murphy and Riley (*Anal. Chim. Acta*, 27: 31, 1962) and is so superior to other methods in terms of the rapidity and ease of analysis that it probably represents the ultimate in sea-going techniques.

METHOD

A. CAPABILITIES

Range: 0.03–5 $\mu\text{g-at/liter}$

1. PRECISION AT THE 3 $\mu\text{G-AT/LITER}$ LEVEL

The correct value lies in the range:

Mean of n determinations $\pm 0.03/n^{\frac{1}{2}}$ $\mu\text{g-at/liter}$.

2. PRECISION AT THE 0.3 $\mu\text{G-AT/LITER}$ LEVEL

The correct value lies in the range:

Mean of n determinations $\pm 0.02/n^{\frac{1}{2}}$ $\mu\text{g-at/liter}$.

3. LIMIT OF DETECTION

The smallest amount of phosphate that can be detected with certainty is about 0.03 $\mu\text{g-at P/liter}$.

Reject duplicate determinations if extinction values differ by more than 0.02 in the extinction range 0.5–1.0 or more than 0.01 in the extinction range 0.1–0.5.

If the duplicate extinction values differ by less than the above limits, take a mean value.

B. OUTLINE OF METHOD

The seawater sample is allowed to react with a composite reagent containing molybdic acid, ascorbic acid, and trivalent antimony. The resulting complex heteropoly acid is reduced *in situ* to give a blue solution the extinction of which is measured at 8850 Å.

C. SPECIAL APPARATUS AND EQUIPMENT

130-ml capacity screw-capped polyethylene bottles marked on the side at 100 ml (± 2 ml) with a band of black tape.

D. SAMPLING PROCEDURE AND SAMPLE STORAGE

130-ml polyethylene bottles should be filled completely with sample after rinsing them twice with the water to be analysed. The analysis should be commenced as soon as possible, preferably within $\frac{1}{2}$ hr, certainly before 2 hr. Samples should be kept in a cool dark place and not warmed to room temperature until the analysis is to be commenced. If the analysis has to be delayed for more than about 1 hr refrigerate the samples to 0 C or less. Quick freezing in a 40% glycol bath at -20 C (freeze to this temperature within 30 min of collection) stabilizes samples for many months and this technique should be used for the most precise work on samples drawn from the euphotic zones in tropical or sub-tropical waters. There is conflicting evidence concerning the loss of phosphate to polyethylene when samples are stored at room temperature but evidence indicates that this should be avoided (Hassenteufel, Jagitsch, and Koczy, *Limnol. Oceanog.*, 8: 152, 1963).

E. SPECIAL REAGENTS

1. AMMONIUM MOLYBDATE SOLUTION

Dissolve 15 g of analytical reagent quality ammonium paramolybdate $(\text{NH}_4)_6\text{Mo}_7\text{O}_{24}\cdot 4\text{H}_2\text{O}$ (preferably finely crystalline), in 500 ml of distilled water. Store in a plastic bottle out of direct sunlight. The solution is stable indefinitely.

2. SULPHURIC ACID SOLUTION

Add 140 ml of concentrated (sp gr 1.82) analytical reagent quality sulphuric acid to 900 ml of distilled water. Allow the solution to cool and store it in a glass bottle.

3. ASCORBIC ACID SOLUTION

Dissolve 27 g of good quality ascorbic acid in 500 ml of distilled water. Store the solution in a plastic bottle frozen solid in a freezer. Thaw for use and refreeze at once. The solution is then stable for many months but should not be kept for more than a week at laboratory temperatures.

4. POTASSIUM ANTIMONYL-TARTRATE SOLUTION

Dissolve 0.34 g of good quality potassium antimonyl-tartrate (tartar emetic) in 250 ml of water, warming if necessary. Store in a glass or plastic bottle. The solution is stable for many months.

5. MIXED REAGENT

Mix together 100 ml ammonium molybdate, 250 ml sulphuric acid, 100 ml ascorbic acid, and 50 ml potassium antimonyl-tartrate solutions. Prepare this reagent for use and discard any excess. Do not store for more than about 6 hr. The above quantity is suitable for about 50 samples.

F. EXPERIMENTAL

PROCEDURE

1. Warm the samples to a temperature between 15 and 30 C in a thermostated water bath (Note *a*) and measure the extinction of samples to obtain a turbidity correction (Note *b*; see also Sect. G).

2. To 100 ml of sample add 10 ± 0.5 ml of mixed reagent from a 25-ml measuring cylinder and mix *at once*.

3. After 5 min and preferably within the first 2–3 hr (Note *c*) measure the extinction of the solution in a 10-cm cell against distilled water at a wavelength of 8850 Å. If a filter-type absorptiometer is used choose a filter transmitting light of the longest possible wavelength but some loss of sensitivity will occur. Unless adjacent samples are known to have extinction values within about 25% of each other the absorptiometer cell should be rinsed with each new solution before filling.

4. Correct the measured extinction by subtracting both the turbidity and reagent blanks (*see* Sect. G). Calculate the phosphate concentration in microgram-atoms of phosphate phosphorus per liter ($\mu\text{g-at P/liter}$) from the expression:

$$\mu\text{g-at P/liter} = \text{corrected extinction} \times F$$

where *F* is a factor obtained as described in Section H below. Report results to three significant figures. Silicon causes no interference, and interference from arsenic is normally negligible.

NOTES

(*a*) The method appears to have no significant temperature coefficient (less than 0.2% per C°) between 15 C and 30 C but it is probably wisest to have samples at a temperature within this range.

(*b*) This measurement is rarely required for every sample (*see* Sect. G). If the turbidity gives an extinction exceeding 0.05 the suspended matter may adversely affect the method and solutions should be filtered.

(*c*) The extinction reaches a maximum in about 5 min and stays constant for many hours. Blank solutions become yellow but corrected extinction values change by only about 10% (decrease) even after several days. For the most precise work it is preferable to measure the light absorption within 2–3hr as there may be slight changes in the first $\frac{1}{2}$ day.

G. DETERMINATION OF BLANK

1. CELL-TO-CELL BLANKS

When both sample and distilled water cells are filled with distilled water the extinction of one against the other should be 0.000. Due to slight optical defects a slight positive or negative value may be found. This is allowed for when turbidity blanks are subtracted (*see* 3 *below*) but the value should be found when determining the reagent blank. The water in the distilled water cell should be changed every day or two as marked turbidities can result even in distilled water if it remains in the cell for too long.

2. REAGENT BLANK FOR THE STANDARD METHOD

Carry out the method exactly as described in Section F, paragraphs 2–4 inclusive, using distilled water in place of 100 ml of sea water. Correct the resulting extinction for the cell-to-cell blank. The reagent blank should not exceed 0.02. If it exceeds this, use redistilled water. Should the blank persist the ammonium molybdate reagent is suspect. The reagent blank, although small, is not insignificant for the most accurate work or when less than $1.5 \mu\text{g-at P/liter}$ is being determined. It should be measured for each new batch of molybdate reagent and checked at weekly intervals during a cruise.

3. SEAWATER TURBIDITY BLANK

This may be a very appreciable fraction of the total extinction in surface waters and should be determined on the surface and 10-m samples of each cast. Measure at progressively greater depths until the value becomes approximately constant. This value (generally less than 0.01 below 25 m in offshore waters) is then roughly equal to the cell-to-cell blank (Sect. G, 1 *above*) and may often be slightly negative.

Turbidity blanks should be measured on the sample solutions after they have been warmed to room temperature, just prior to adding the molybdate reagent. If 130-ml polyethylene bottles are filled to the brim with sample, enough is present for the turbidity blank leaving nearly 100 ml for analysis. A few milliliters may be poured back from the absorptiometer cell if necessary. Extinction measurements become inaccurate if turbidity blank exceeds 0.1.

H. CALIBRATION

1. STANDARD PHOSPHATE SOLUTION

Dissolve 0.816 g of anhydrous potassium dihydrogen phosphate, KH_2PO_4 , in 1000 ml of distilled water. Store in a dark bottle with 1 ml of chloroform. The solution is stable for many months.

$$1 \text{ ml} \equiv 6.0 \text{ } \mu\text{g-at P}$$

Dilute 10.0 ml of this solution to 1000 ml with distilled water (*see below*). Store in a dark bottle with 1 ml of chloroform. The solution should be stable for many weeks but, for surety, should be made afresh about once every 10 days.

$$1 \text{ ml} \equiv 6.0 \times 10^{-2} \text{ } \mu\text{g-at P}$$

$$1 \text{ ml} \equiv 0.60 \text{ } \mu\text{g-at P/liter in 100 ml of seawater sample}$$

2. PROCEDURE

Prepare four standards, consisting of 5.0 ml of the dilute phosphate solution (equivalent to 3.0 $\mu\text{g-at P/liter}$) made to a volume of exactly 100 ml with distilled water in a 100-ml graduated measuring cylinder (use with care). Transfer the solutions to dry polyethylene bottles and fill two more bottles with distilled water to act as blanks. Carry out the phosphate determination exactly as described in Section F, paragraphs 2-4.

Calculate the factor F from the expression:

$$F = \frac{3.00}{E_s - E_b}$$

where E_s is the mean extinction of the four standards and E_b is the mean extinction of the two blanks (*not* corrected for cell-to-cell blanks). The value for F is completely independent of salinity (with up to 35% present) and hence can be determined using distilled water and the method can be used unchanged with freshwater samples. The value for F is also constant, provided that fresh reagents and the same spectrophotometer, etc., are used each time, and hence need only be checked at infrequent intervals. The value, when radiation of 8850 Å is used, should be about 5.

II.2.II. DETERMINATION OF REACTIVE PHOSPHORUS (LOW LEVELS)

INTRODUCTION

This method is an extension of the procedure developed by Murphy and Riley (*Anal. Chim. Acta*, 27: 31, 1962) using an extraction method (Proctor and Hood, *J. Marine Res.*, 13: 122, 1954). Details are given by Stephens (*Limnol. Oceanog.*, 8: 361, 1963). The method is very sensitive and particularly suitable for the determination of phosphorus in oligotrophic areas and many freshwater lakes.

METHOD

A. CAPABILITIES

Range: 0.006–0.30 $\mu\text{g-at/liter}$

1. PRECISION AT THE 0.15 $\mu\text{G-AT/LITER}$ LEVEL

The correct value lies in the range:

Mean of n determinations $\pm 0.006/n^{\frac{1}{2}}$ $\mu\text{g-at/liter}$.

2. LIMIT OF DETECTION

The smallest amount of phosphate that can be detected with certainty is about 0.006 $\mu\text{g-at/liter}$. Reject duplicate determinations if extinction values differ by more than 0.03 in the extinction range 0.5–1.0 or more than 0.02 in the extinction range 0.1–0.5.

B. OUTLINE OF METHOD

The water sample is allowed to react with a composite reagent containing molybdic acid, ascorbic acid, and trivalent antimony. The resulting blue-coloured complex is extracted with isobutanol and its extinction measured at 6900 Å.

C. SPECIAL APPARATUS AND EQUIPMENT

Use 250-ml separatory funnels with wide stems, cut off near to the top, to facilitate drainage.

All glassware should be thoroughly cleaned with concentrated sulphuric acid and well rinsed. Apparatus not in use should be kept covered with 0.1% sulphuric acid in distilled water solution.

D. SAMPLING PROCEDURE

The 250-ml polyethylene bottles should be filled completely with sample after rinsing them twice with the water to be analysed. The analysis should be commenced as soon as possible, preferably within $\frac{1}{2}$ hr and before 2 hr. Samples should be kept in a cool, dark place and not warmed to room temperature until the analysis is to commence. For delays of more than 1 hr refrigerate the samples to 0 C or lower. Quick freezing at -20 C stabilizes the samples for some time; however, samples should not be kept longer than 3 weeks.

E. SPECIAL REAGENTS

1. AMMONIUM MOLYBDATE SOLUTION

Prepare as described in Part II.2.I, Section E 1.

2. SULPHURIC ACID SOLUTION

Prepare as described in Part II.2.I, Section E 2.

3. ASCORBIC ACID SOLUTION

Prepare as described in Part II.2.I, Section E 3.

4. POTASSIUM ANTIMONYL-TARTRATE SOLUTION

Prepare as described in Part II.2.I, Section E 4.

5. MIXED REAGENT

Prepare as described in Part II.2.I, Section E 5.

6. ISO-BUTANOL

Wash good quality iso-butanol with two small aliquots of distilled water, about 150 ml water to 1000 ml iso-butanol. Dry the alcohol over potassium carbonate and distill, collecting the fraction boiling between 105 C and 109 C (corrected).

7. GLASS REDISTILLED WATER

8. ABSOLUTE ETHANOL

F. EXPERIMENTAL

PROCEDURE

1. Warm the samples to a temperature between 15 C and 30 C (Note *a*).
2. Measure 200 ± 2 ml of sample with a graduated cylinder and pour into a 250-ml separatory funnel.
3. To the sample in funnel add 20 ± 1 ml of mixed reagent from a 25-ml graduated cylinder and mix *at once*.
4. After 10 min and within the next 2 hr add 28 ± 0.2 ml iso-butanol and shake the funnel for 60 sec (Note *b*).
5. Allow the funnel contents to stand for 5 min and separate off the lower aqueous phase.
6. Run the iso-butanol fraction into a clean, dry 10-ml graduated cylinder allowing 10 sec for the funnel to drain.
7. Make the alcoholic extract up to 10 ± 0.1 ml with absolute ethanol and mix by swirling (Note *c*).
8. Measure the extinction of the extract in a dry 10-ml, 10-cm absorption cell against iso-butanol at a wavelength of 6900 Å. If a filter-type absorptiometer is used, choose a filter having a maximum transmission in the region of 7000 Å.
9. Correct the measured extinction by subtracting the reagent blank (*see* Sect. G). Calculate the phosphate concentration in microgram atoms of phosphate phosphorus per liter ($\mu\text{g-at P/liter}$) from the expression:

$$\mu\text{g-at P/liter} = \text{corrected extinction} \times F$$

where *F* is a factor obtained as described in Section H. Report results to three significant figures. Silicon and arsenic cause negligible interference.

NOTES

- (a) The method appears to have no significant temperature coefficient (less than 0.2% per

1 C) between 15 C and 30 C but it is wisest to have samples at a temperature within this range.

(b) Erratic results may occur with less than 60 sec vigorous shaking. The extracted colour is stable in the alcoholic phase for at least 2 hr. Iso-butanol is more soluble in distilled water than in sea water and 28 ml has been chosen to give a recoverable extract volume not exceeding 9.5 ml in water of 33‰ salinity.

(c) The addition of ethanol removes water droplets.

G. DETERMINATION OF BLANKS

1. CELL-TO-CELL BLANKS

When both sample and reference cells are filled with iso-butanol the extinction of one against the other should be 0.000. Due to slight optical defects a slight positive or negative value may be found. This is allowed for when reagent blanks are subtracted but the value should be determined.

2. REAGENT BLANKS

Carry out the method exactly as described in Section F, paragraphs 2-9 inclusive, using redistilled water in place of the sample. The reagent blank corrected for cell-to-cell blank should not exceed 0.100. If the blank exceeds this amount either the molybdate reagent or the iso-butanol is suspect. The reagent blank should be determined for each batch of samples measured.

H. CALIBRATION

1. STANDARD PHOSPHATE SOLUTION

Dissolve 0.816 g of anhydrous potassium dihydrogen phosphate, KH_2PO_4 , in 1000 ml of distilled water. Store in a dark bottle with 1 ml of chloroform. The solution is stable for many months.

$$1 \text{ ml} \equiv 6.0 \mu\text{g-at P}$$

Dilute 5 ml of this solution to 1000 ml with distilled water. Store in a dark bottle with 1 ml of chloroform. Fresh dilute standards should be made up once a week.

$$1 \text{ ml} \equiv 0.03 \mu\text{g-at P}$$

$$\text{or } 1 \text{ ml} \equiv 0.15 \mu\text{g-at P/liter in 200-ml water sample}$$

2. PROCEDURE

Prepare four standards consisting of 1.0 ml of dilute phosphorus solution and 200 ml of redistilled water. Prepare two blanks using redistilled water. Carry out the determination exactly as described in Section F, paragraphs 2-9.

Calculate the factor F from the expression:

$$F = \frac{0.15}{E_s - E_b}$$

where E_s is the mean extinction of the four standards and E_b is the mean extinction of the two blanks (not corrected for cell-to-cell blanks). The value for F is independent of salinity, but for most precise work in determining phosphate concentrations in sea water use a synthetic sea water in place of redistilled water as a larger volume of extract is obtained. The value for F should be near 0.375.



II.3. DETERMINATION OF TOTAL PHOSPHORUS

INTRODUCTION

In this method the total phosphorus, in a filtered or unfiltered sample, is mineralized by evaporating the sample to fumes with perchloric acid. We have had no experimental evidence to indicate that any form of combined phosphorus in sea water can withstand this treatment without being mineralized and brought into solution. The method is taken, basically, from the procedure described by Hansen and Robinson (*J. Marine Res.*, 12: 31, 1953) but there have been several major modifications designed to give a better "blank" determination, to facilitate the routine use of the method, and to eliminate any interference from arsenate.

METHOD

A. CAPABILITIES

Range: 0.08–6 $\mu\text{g-at/liter}$

1. PRECISION AT THE 2.5 $\mu\text{G-AT/LITER}$ LEVEL

The correct value lies in the range:

Mean of n determinations $\pm 0.13/n^{\frac{1}{2}}$ $\mu\text{g-at/liter}$.

2. PRECISION AT THE 0.5 $\mu\text{G-AT/LITER}$ LEVEL

The correct value lies in the range:

Mean of n determinations $\pm 0.08/n^{\frac{1}{2}}$ $\mu\text{g-at/liter}$.

B. OUTLINE OF METHOD

A 50-ml sample of sea water is evaporated with perchloric acid. Chloride is replaced by perchlorate and much of the arsenic is volatilized. The residue is heated and any organic matter is oxidized, liberating phosphorus as inorganic phosphate. The total phosphate is then determined, after adding 50 ml of water, as described in Part II.2.

C. SPECIAL APPARATUS AND EQUIPMENT

Use 125-ml Pyrex Erlenmeyer flasks. Three small dents, 1–2 mm deep, are made symmetrically around the lip of each flask which is covered with a 2-inch diam coverglass.

Clean Pyrex Erlenmeyer flasks have been found to give no phosphate contamination. Flasks should be retained especially for the present method, covered by aluminium foil, and not put into general circulation. Before their initial use, they should be cleaned by fuming after the addition of about 30 ml of water, 20 ml of concentrated hydrochloric acid, and 10 ml of perchloric acid solution. The perchloric acid is refluxed vigorously in each flask for about 1 hr. A blank determination (*see Sect. G below*) should then be carried out on each flask before it is finally put into use. The flasks are rinsed thoroughly with distilled water after each determination and stored dry.

Antibumping devices consisting of carborundum granules, sized about $\frac{1}{2}$ – $\frac{1}{8}$

inch and cleaned by fuming with perchloric acid for 1 or 2 hr and then rinsing thoroughly with hot distilled water. The granules should only be handled with forceps and two used with each flask. The granules and 2-inch coverglasses should be boiled for a few minutes in 50% v/v hydrochloric acid before use or after a prolonged shutdown period.

D. SAMPLING PROCEDURE AND SAMPLE STORAGE

If the total phosphorus is to be determined on Millipore-filtered samples the filtration must take place immediately after the samples are taken from the sea.

It appears to be impossible to prevent a very small, but detectable, pick-up of phosphorus from glassware over a sufficient period of time but Pyrex boiling tubes, 200 × 25 mm holding about 80–90 ml, have proved satisfactory for storing samples for total phosphate for a period exceeding a month. The tubes are cleaned thoroughly in hot chromic-sulphuric acid for several hours, rinsed thoroughly with distilled water and conditioned by being allowed to stand full of slightly acidic water (1 drop of concentrated hydrochloric acid) for several months. When not in use the tubes should be kept nearly full of acidic water and covered with a clean square of Parafilm or aluminium foil. In no circumstances should a cork or rubber stopper be used as either can introduce contamination. This water is emptied, and the tube drained as dry as possible, immediately before the sample is placed in it for storage.

Exactly 50 ml of sample is pipetted into the tube and 1–2 drops of concentrated hydrochloric acid added to acidify the seawater sample during storage. The tubes should be re-stoppered immediately with Parafilm sheeting. The very slight phosphorus pick-up which may still occur during a longer cruise (*ca.* 0.1 $\mu\text{g-at P/liter}$ or less) can be minimized by storing the boiling tubes in a deep-freeze and by assessing a mean blank correction. This is obtained by storing synthetic sea water of known total phosphorus content in three or four tubes selected at random and redetermining the total phosphorus when the batch of samples is analysed.

Probably the best technique in phosphorus analysis is to do any filtrations within 1 hr of taking samples (which are kept cool and dark) and then quickly deep-freeze filtrates to -20 C in polyethylene bottles. All analyses should be carried out immediately the samples are quick-thawed and no refreezing and thawing should be permitted.

E. SPECIAL REAGENTS

1. PERCHLORIC ACID SOLUTION

Dilute 300 ml of 70–72% analytical reagent quality perchloric acid, HClO_4 , to 1 liter with distilled water. Store in a clean Pyrex glass bottle.

2. POTASSIUM IODIDE SOLUTION

Dissolve 5 g of analytical quality potassium iodide in 100 ml of water. Store in a glass-stoppered dropping bottle. The solution is stable and need not be discarded when a slight brown colouration develops.

3. DILUTE AMMONIA SOLUTION

The ammonia solution must be taken from a freshly opened bottle of concentrated ammonia solution (sp gr 0.9) of analytical reagent quality. Dilute 100 ml of

this solution to 500 ml with distilled water and store in a tightly stoppered polyethylene bottle. The solution is stable except for a slight loss of ammonia gas which may become appreciable as the solution is used. For surety it should be prepared fresh every week if in continual use or, in any event, every 2-3 weeks.

4. DILUTION WATER

This is distilled water to which has been added 2.0 ml of concentrated hydrochloric acid (sp gr 1.14) for every liter. The solution should be stored in a polyethylene bottle or carboy.

5. AMMONIUM MOLYBDATE SOLUTION

Prepare as described in Part II.2, Section E.1.

6. SULPHURIC ACID SOLUTION

Prepare as described in Part II.2, Section E.2.

7. ASCORBIC ACID SOLUTION

Prepare as described in Part II.2, Section E.3.

8. POTASSIUM ANTIMONYL-TARTRATE SOLUTION

Prepare as described in Part II.2, Section E.4.

9. MIXED REAGENT

Prepare as described in Part II.2, Section E.5.

F. EXPERIMENTAL

PROCEDURE

1. The quantity of perchloric acid solution used in this method depends upon the approximate salinity of a sample (Note *a*). The reagent volume should be correct to the nearest 0.5 ml according to the following:

<i>S</i> %	<i>Volume of perchloric acid solution</i>
15	5.5
20	6.5
25	7.5
30	8.5
33	9.5
36	10.0
38	10.5

Pour the sample from the boiling tube (which initially contained exactly 50 ml) into the special 125-ml Erlenmeyer flask. Add the requisite volume of perchloric acid solution to a suitable dispensing device and introduce about half of the reagent to the empty boiling tube. Rub the sides of the tube vigorously with this reagent by means of a small rubber policeman and empty the tube into the flask (Note *b*). Repeat this operation with the remainder of the acid and finally rinse the boiling tube and the policeman into the flask with a little distilled water (not more than about 10 ml).

2. Place 2 or 3 carborundum granules into the flask and evaporate the contents

of the flask with vigorous boiling on a hot-plate until the volume is reduced to about 15 or 20 ml. Reduce the heat somewhat, add 2–3 drops (*ca.* 0.1 ml) of potassium iodide reagent and place the coverglass over the mouth of the flask (Note *d*).

3. Continue the evaporation carefully until solid material *just* begins to separate (Note *c*). Lower the temperature a little and continue the evaporation more cautiously until all water and acid are removed and perchloric acid refluxes down the sides of the flask (Note *e*). Finally place the flasks on the hottest part of a hot-plate (*ca.* 400 C) and heat for 10 min with the perchloric acid refluxing. Only a very slight loss of vapour should occur if a coverglass is in place.

4. Remove the flask and allow it to cool until it can be held against the palm of the hand. Add 5 ml of dilute ammonia solution and rinse the coverglass into the flask with a few drops of distilled water. Place the flask back on a hot-plate at a moderate heat and boil to remove all excess ammonia. Then evaporate the contents to dryness by boiling *gently*. If the boiling is very rapid at the time solid commences to separate very bad “bumping” may occur. As the contents become solid remove the coverglass and continue the evaporation until all the water is removed but do not overheat (Note *f*).

5. Remove the flask from the hot-plate and allow it to cool to room temperature. Add, by means of a pipette, exactly 50 ml of dilution water and warm the solution slightly until it becomes clear (Note *g*). Finally cool the sample to a temperature between 15 and 30 C in a water bath (Note *h*).

Warning. Refer again to Note *g* before continuing.

6. Add 5 ± 0.5 ml of mixed reagent from a 10-ml measuring cylinder and mix at once.

7. After 5 min and preferably within the first 2–3 hr (Note *i*) measure the extinction of the solution in a 10-cm cell against distilled water at a wave-length of 8850 Å. If a filter-type absorptiometer is used choose a filter transmitting light of the longest possible wavelength but some loss of sensitivity will occur.

8. Correct the measured extinction by subtracting both the turbidity and reagent blanks (*see* Sect. G). Calculate the total phosphate concentration in microgram-atoms of total phosphorus per liter ($\mu\text{g-at P/liter}$) from the expression:

$$\mu\text{g-at P/liter} = \text{corrected extinction} \times F$$

where *F* is a factor determined for each batch of samples evaporated (Sect. H *below*). Report results to three significant figures.

NOTES

(*a*) For correct neutralization (*see* 4) and to ensure satisfactory behaviour at the fuming stage (*see* 3), the excess perchloric acid, after the chloride in the sea water is displaced, should lie in the range of about 0.4–0.8 ml of 70% acid. The quantities given in Section F. 1 ensure this, if judged to the nearest 0.5 ml. The salinity need only be known to about 1‰.

(*b*) If bacterial or algal growth has occurred since the sample was taken some phosphorus may be extracted from solution and held on the walls of the vessel in organic combination.

(*c*) Severe “bumping” is encountered in the early stages of evaporation unless an anti-bumping device such as the capillaries specified in Section C is added; also when solid separates, unless the correct volume of perchloric acid has been added, “bumping” may occur.

(d) Any arsenic present in the seawater sample is reduced to the trivalent form by iodine in acid solutions and is subsequently lost by evaporation as chloride. Tests have shown that arsenic initially present to the extent of several microgram-atoms of As^{V} per liter gives no interference.

(e) It is essential that all hydrochloric acid vapour and water are removed at this stage. Some spurting of the semi-solid mass in the flask will occur as the water is finally removed but this will not be excessive and may be disregarded as the sides of the flask will be cleaned during the subsequent refluxing of perchloric acid. The refluxing of perchloric acid is quite characteristic and is seen as a heavy oily ring of liquid pouring down the inner sides. The top of the flask and the coverglass will become almost dry and only a *little* heavy vapour will escape from the mouth of the flask. The fumes in the flask almost disappear unless a little air is blown in when a dense white vapour forms.

(f) This treatment with ammonia and evaporation ensures that a neutral dry residue of reproducible volume is left irrespective of the amount of excess perchloric acid left at the fuming stage (3). Subsequent neutralization with varying volumes of alkali is thus avoided, producing a more rapid and reproducible technique with easier blank control. The contents of the flask should *not* be overheated at this stage. A few tenths of a milliliter of water held on the inner sides of the flask may be disregarded as this will largely evaporate when the flask is allowed to cool.

(g) The residue, after ammonia treatment and evaporation, contains a little magnesium hydroxide. The small amount of hydrochloric acid present in the dilution water ensures that all hydroxides dissolve and the remaining amount of acid is then too small to interfere with subsequent colour development. Some samples, generally from deep ocean water, never completely clear at this stage for reasons we do not fully understand. Solutions should be warmed to about 50 C for up to about 15 min but no longer. Some of the remaining turbidity may disappear on adding the mixed reagent but if any persistent turbidity is suspected make a correction as described in Section G.

(h) The method appears to have no significant temperature coefficient but it is probably wisest to have samples at a temperature within this range.

(i) The extinction reaches a maximum in about 5 min and traces of chlorite formed during fuming do not seem to interfere. Thereafter the extinction (corrected for blank) is very steady but should preferably be measured within 2-3 hr as there may be slight changes.

G. DETERMINATION OF BLANK

1. CELL-TO-CELL BLANKS

When both sample and distilled water cells are filled with distilled water the extinction of one against the other should be 0.000. Due to slight optical defects a slight positive or negative value may be found. The water in the distilled water cell should be changed every day as marked turbidities can result even in distilled water if it remains in the cell for too long.

2. TURBIDITY BLANKS

If turbidity is suspected (it should not exceed an extinction of 0.05 on a 10-cm cell) fill a clean dry 10-cm cell with the sample (before adding the mixed reagent), measure the extinction at 8850 Å, and empty the spectrophotometer cell back into the flask. Drain the cell but do not wash it. The retention of about 0.5 ml of sample in the cell will cause little error. Determine all turbidity blank corrections before adding mixed reagent to the samples. Deduct any cell-to-cell blank from the turbidity blank before adding this value to the reagent blank (*see* the following).

3. REAGENT BLANK

The amount of phosphorus in the perchloric acid reagent is very small and

variations in the amount of this acid used may be neglected. A blank determination is only necessary when a new batch of perchloric acid, ammonium molybdate, or dilute ammonia is used, and the extinction should not exceed about 0.05. It should be checked every few days, in duplicate, during a run of analyses.

Place 8 ml of perchloric acid and 2–3 drops of potassium iodide solution into a conical flask. Evaporate, without coverglass, until solid separates and only a few tenths of a milliliter of perchloric acid remains. Cool somewhat, add 5 ml of dilute ammonia solution, and evaporate but do not bake to absolute dryness. Leave 1–2 ml of liquid or the formation of polyphosphate will be excessive. Continue exactly as described in Section F, paragraphs 5–7, and correct the resulting extinction for any cell-to-cell blank.

H. CALIBRATION

1. STANDARD PHOSPHATE SOLUTION

Prepare as described in Part II.2, Section H.1, but dilute the concentrated standard 5.0 ml to 1000 ml with distilled water before use.

1 ml \equiv 0.60 $\mu\text{g-at P/liter}$ in 50 ml of water.

2. SYNTHETIC SEA WATER

Dissolve 25 g of analytical reagent quality sodium chloride and 8 g of magnesium sulphate heptahydrate, $\text{MgSO}_4 \cdot 7\text{H}_2\text{O}$, in each liter of distilled water.

3. PROCEDURE

The evaporation and fuming procedure described in this method result in a slight, but reproducible, loss of phosphorus which may amount to several per cent. If fuming is taken to dryness the loss approaches 15%. The explanation for this is obscure but it appears as if some phosphoric acid may co-distill with perchloric acid vapour and a certain fraction of the phosphate is condensed to polyphosphates which do not completely hydrolyse in ammonia solution and which do not react with molybdate. For safety, therefore, it is best to calibrate each batch of samples by taking standards throughout the entire method.

Add 50 ml of synthetic sea water to each of five flasks. Reserve two flasks for blank determinations and to each of the three others add 5.0 ml of the dilute phosphate solution (equivalent to 3 $\mu\text{g-at P/liter}$ in 50 ml). Add 8.0 ml of perchloric acid solution to each flask and carry these standards and blanks through the full method as described in Section F, paragraphs 2–7, inclusive.

Calculate the factor F from the expression:

$$F = \frac{3.00}{E_s - E_b}$$

where E_s is the mean extinction of the three standards and E_b is the mean extinction of the two blanks (*not* corrected for cell-to-cell blanks).

II.4. DETERMINATION OF INORGANIC POLYPHOSPHATE

INTRODUCTION

This procedure is based on the method of Strickland and Solorzano (*Limnol. Oceanogr.* 13: 515, 1968). It relies on the fact that organic phosphate can be converted to orthophosphate without the hydrolysis of polyphosphates by the action of ultraviolet radiation (Armstrong, Williams, and Strickland, *Nature*, 211: 481, 1966) and then any polyphosphate can be converted to orthophosphate by acid hydrolysis. The method measures inorganic and organic polyphosphates.

METHOD

A. CAPABILITIES

The range and precision of this method have not been determined in detail but appear to be little different from those given for II.2.I.

B. OUTLINE OF METHOD

The filtered sample is exposed to short wavelength ultraviolet radiation until all organically combined phosphate is destroyed and a determination of orthophosphate is then made on an aliquot. The remainder of the sample is heated with acid until all polyphosphates are hydrolysed and the orthophosphate is again determined. The difference between these two results measures the polyphosphate in the sample.

C. SPECIAL APPARATUS AND EQUIPMENT

Use 50-ml capacity stoppered graduated glass measuring cylinders.

Quartz tubes and UV lamp equipment as described in the NOTES ON APPARATUS section. Temperatures should be kept below 70 C in the tubes.

D. SAMPLING PROCEDURE

See II.2.I.D.

E. SPECIAL REAGENTS

1. AMMONIUM MOLYBDATE SOLUTION

Prepare as described in II.2.I.E.1.

2. SULPHURIC ACID SOLUTION

Prepare as described in II.2.I.E.2.

3. ASCORBIC ACID SOLUTION

Prepare as described in II.2.I.E.3.

4. POTASSIUM ANTIMONYL-TARTRATE SOLUTION

Prepare as described in II.2.I.E.4.

5. MIXED REAGENT

Prepare as described in II.2.I.E.5.

6. HYDROCHLORIC ACID SOLUTION

Add 300 ml of distilled water to 200 ml of concentrated hydrochloric acid (sp gr 1.18). Store in a glass bottle.

7. HYDROGEN PEROXIDE

Use the best "30 per cent" analytical reagent quality solution.

F. EXPERIMENTAL PROCEDURE

1. Add about 105 ml of sample to a quartz irradiation tube after first rinsing the tube with a little sample. Add 1–2 drops of hydrogen peroxide, mix, and irradiate for 1–1.5 hr (Note *a*). Cool the tube and contents to room temperature.

2. Rinse a clean 50-ml stoppered glass graduated cylinder with 1 or 2 ml of the irradiated water and then fill the cylinder to the 50-ml mark.

3. To the remaining water in the tube add, with a bulb pipette, 1.0 ml of hydrochloric acid solution. Mix and place the quartz tube in a boiling water bath for 2 hr (Note *b*).

4. Cool the tube and contents to room temperature, use 1 or 2 ml to rinse a clean 50-ml stoppered glass graduated cylinder and then fill the cylinder to the 50 ml mark.

5. Add 1.0 ml of hydrochloric acid to the first cylinder, containing the irradiated but unhydrolysed sample (Note *c*), and then to both cylinders add 5 ml of mixed reagent from a 5 ml measuring cylinder, invert the cylinders two or three times to mix and set aside for at least 5 min.

6. Continue determinations exactly as described in II.2.I,F.3. If E_1 is the extinction of the irradiated and hydrolysed sample and E_2 is the extinction of the irradiated sample,

$$\mu\text{g-at polyphosphate-P/liter} = (E_1 - E_2)F \times 1.02$$

where F is a factor obtained as described in II.2.I,H (Note *d*).

NOTES

(*a*) This treatment destroys all phosphorus-containing organic molecules and liberates orthophosphate. Organic or inorganic polyphosphate linkages are not broken at seawater pH, provided that temperatures do not exceed 60–70 C.

(*b*) This treatment hydrolyses tripolyphosphate and linear polyphosphate glasses with up to 70 atoms of phosphorus, to give orthophosphate. The time is not critical and could possibly be shortened but 2 hr gives a safe minimum. If hydrolysis is undertaken in the quartz tubes fewer contamination and transfer errors are likely.

(*c*) This allows for any blank that may be introduced by the hydrochloric acid.

(*d*) The value for F is the same for this method as for the reactive phosphate method and need not be redetermined. A factor of 1.02 allows for the addition of hydrochloric acid.

G. DETERMINATION OF BLANKS

This is a "difference" method and has no blank correction (*see* Note *c*).

H. CALIBRATION

See II.2.I,H (Note *d*).

II.5. DETERMINATION OF REACTIVE SILICATE

INTRODUCTION

All methods for the determination of silicate in sea water depend upon the production of the silicomolybdate complex. Methods that rely on the direct measurement of the light absorption of this yellow substance (e.g. Robinson and Thompson, *J. Marine Res.*, 7: 49, 1948) are much less sensitive and satisfactory than those that first bring about a reduction of the yellow complex to a more intensely coloured blue compound.

A reduction by stannous chloride (Armstrong, *J. Marine Biol. Assoc. U.K.*, 30: 149, 1951) gives the most sensitive technique but conditions, especially time intervals, are rather critical and we have preferred to use a metol reduction, which is less exacting. The method described here is a very slight modification of that given by Mullin and Riley (*Anal. Chim. Acta*, 12: 162, 1955). Some work on the basic chemistry of silicomolybdate formation was carried out by the senior author (Strickland, *J. Am. Chem. Soc.*, 74: 862 *et seq.*, 1952).

It must be remembered that not all forms of silica in "solution" will react to give the silicomolybdate complex. Silicic acid readily polymerises at the pH of sea water and only straight-chain polymers of relatively short length will react with molybdate at any appreciable speed. Polymers with even as little as three or four silicic acid units are probably "unreactive" under the conditions of the method described below (Chow and Robinson, *Anal. Chem.*, 25: 646, 1953; Alexander, *J. Am. Chem. Soc.*, 75: 5655, 1953, and 76: 2094, 1954). To avoid ambiguity, therefore, the term "reactive silicate" is best used, it being understood that whilst this quantity may not be so great as the total dissolved silicic acid it probably gives a meaningful measure of the amount available to growing plant cells.

METHOD

A. CAPABILITIES

Range: 0.1–140 $\mu\text{g-at/liter}$

1. PRECISION AT THE 100 $\mu\text{G-AT/LITER}$ LEVEL

The correct value lies in the range:

Mean of n determinations $\pm 2.5/n^3$ $\mu\text{g-at/liter}$ (using 1-cm cells).

2. PRECISION AT THE 10 $\mu\text{G-AT/LITER}$ LEVEL

The correct value lies in the range:

Mean of n determinations $\pm 0.25/n^3$ $\mu\text{g-at/liter}$ (using 10-cm cells).

3. LIMIT OF DETECTION

The smallest amount of silicate that can be detected with certainty is about 0.1 $\mu\text{g-at/liter}$ (using 10-cm cells).

Reject duplicate determinations if the extinction values differ

- by: more than 0.05 in the extinction range 0.5–1.0 on a 1-cm cell,
more than 0.025 in the extinction range 0.1–0.5 on a 1-cm cell,
or more than 0.05 in the extinction range 0.5–1.0 on a 10-cm cell.

If duplicate extinction values differ by less than the above limits, take a mean value.

B. OUTLINE OF METHOD

The seawater sample is allowed to react with molybdate under conditions which result in the formation of the silicomolybdate, phosphomolybdate, and arsenomolybdate complexes. A reducing solution, containing metol and oxalic acid, is then added which reduces the silicomolybdate complex to give a blue reduction compound and simultaneously decomposes any phosphomolybdate or arsenomolybdate, so that interference from phosphate and arsenate is eliminated. The extinction of the resulting solution is measured using 1- or 10-cm cells.

C. SPECIAL APPARATUS AND EQUIPMENT

Use one 50-ml capacity stoppered graduated glass measuring cylinder for each silicate determination. These cylinders should be cleaned initially by filling them with chromic-sulphuric acid cleaning mixture. If a set of cylinders is reserved specifically for this determination and rinsed well with distilled water before and after each analysis we have found little evidence of silica contamination from the glass.

Two polyethylene wash bottles, one of at least 300-ml capacity.

D. SAMPLING PROCEDURE AND SAMPLE STORAGE

Samples of sea water for silicate determination should not be stored in glass bottles for more than a few minutes prior to analysis and it is best, therefore, to transfer samples directly into waxed glass or into polyethylene containers. To minimize the effect of diatom multiplication store samples in the dark and for no longer than a day prior to analysis. Storage of low-plankton waters is feasible for about a week if samples are kept cool but some suspended siliceous matter may dissolve and cause an appreciable error if the storage period exceeds a few days. Storage of samples frozen to -20°C is satisfactory for a period of many months but slightly low results (some 5–10% maximum) may occur if samples have concentrations of reactive silicate exceeding $50\ \mu\text{g-at Si/liter}$, especially when concentrations exceed $100\ \mu\text{g-at Si/liter}$. The analysis of deep-water samples is best done at sea as soon as the samples are taken.

E. SPECIAL REAGENTS

1. MOLYBDATE REAGENT

Dissolve 4.0 g of analytical reagent quality ammonium paramolybdate, $(\text{NH}_4)_6\text{MO}_7\text{O}_{24}\cdot 4\text{H}_2\text{O}$ (preferably finely crystalline) in about 300 ml of distilled water. Add 12.0 ml of concentrated hydrochloric acid (12N, sp gr 1.18), mix, and make the volume to 500 ml of distilled water. Store the solution in a polyethylene bottle, in which it is stable for many months provided it is kept out of direct sunlight. The reagent should be discarded if very much white precipitate forms on the sides of the container.

2. METOL-SULPHITE SOLUTION

Dissolve 6 g of anhydrous sodium sulphite, Na_2SO_3 , in 500 ml of distilled water and then add 10 g of metol (*p*-methylaminophenol sulphate). When the metol has dissolved filter the solution through a No. 1 Whatman filter paper and store it in a clean glass bottle which is tightly stoppered. This solution may deteriorate quite rapidly and erratically and should be prepared fresh at least every month.

3. OXALIC ACID SOLUTION

Prepare a saturated oxalic acid solution by shaking 50 g of analytical reagent quality oxalic acid dihydrate $(\text{COOH})_2 \cdot 2\text{H}_2\text{O}$, with 500 ml of distilled water. Decant the solution from the crystals for use. This solution may be stored in a glass bottle and is stable indefinitely.

4. SULPHURIC ACID SOLUTION 50% v/v

Pour 250 ml of concentrated (sp gr 1.82) analytical reagent quality sulphuric acid into 250 ml of distilled water. Cool to room temperature and make the volume to 500 ml with a little extra water.

5. REDUCING REAGENT

Mix 100 ml of metol-sulphite solution with 60 ml of oxalic acid solution. Add slowly, with mixing, 60 ml of the 50% sulphuric acid solution (*above*) and make the mixture to a volume of 300 ml with distilled water. This solution should be prepared for immediate use.

F. EXPERIMENTAL

PROCEDURE

1. Sample solutions should be at a temperature between about 18 and 25 C (Note *a*). Add 10 ml of molybdate solution to a dry 50-ml measuring cylinder fitted with a stopper (Note *b*). Pipette 25 ml of the seawater sample into the cylinder, stopper, mix the solutions, and allow the mixture to stand for 10 min (Notes *c* and *d*).

2. Add the reducing reagent rapidly so as to make the volume exactly 50 ml (Note *b*) and mix immediately (Note *e*).

3. Allow the solution to stand for 2–3 hr (Note *f*) to complete the reduction of the silicomolybdate complex (Note *g*). If precise values are required for amounts of silicon below about 12 $\mu\text{g-at/liter}$ use a 10-cm cell; otherwise measure the extinction of the solution in a 1-cm cell against distilled water. A wavelength of 8100 Å should be used with a spectrophotometer (red-sensitive photocell). If a filter-type absorptiometer is used choose a filter having a maximum transmission above 7000 Å (Note *h*). Unless adjacent samples are known to have extinction values within about 25% of each other the absorptiometer cell should be rinsed with each new solution before filling.

4. Correct the measured extinction by subtracting a reagent blank obtained with a 1-cm or 10-cm cell as appropriate (*see* Sect. G). Calculate the reactive silicate

concentration in microgram-atoms of silicate silicon per liter ($\mu\text{g-at Si/liter}$) from the expression:

$$\mu\text{g-at Si/liter} = \text{corrected extinction} \times F$$

where F is a factor for each length of cell, obtained as described in Section H below. Report results to three significant figures.

NOTES

(a) There is no pronounced temperature effect with this method but samples, especially at the reduction stage, should be at a temperature exceeding 18 C. Temperatures exceeding about 25–30 C must be avoided as this hastens the decomposition of the silicomolybdate complex.

(b) Clean cylinders can be drained dry before use (less than about 0.5 ml water remaining). The ammonium molybdate should be measured directly into the cylinder being used, the volume being correct to 0.5 ml. At sea this reagent and the reducing reagent are conveniently dispensed from polyethylene wash bottles.

(c) The silicate and molybdate must combine before the reducing agent is added. Ten minutes is allowed for this reaction. The addition of the reducing solution must not be delayed for more than a further 30 min or else undesirable changes in the isomeric form of the silicomolybdate complex will take place.

(d) The sample is added to the acid molybdate reagent, rather than in the reverse order, so that the sea water–molybdate mixture is always above a certain acidity. This prevents the possible formation of an undesirable isomeric form of the silicomolybdate complex.

(e) The use of a metol reductant results in a less sensitive method than is found when stannous chloride is used. However, sensitivity is not of prime importance with silicon, which is relatively abundant in sea water in comparison with an element such as phosphorus, and the metol reagent has some advantages. This reagent is more stable than stannous chloride and the stability of the blue colour that it produces with silicomolybdic acid is much greater. As yellow pentavalent molybdenum compounds are not produced the procedure for estimating the "blank" correction is much less complicated than when stannous chloride is employed. Oxalic acid is added to the reducing reagent to decompose any phospho- or arseno-molybdate formed along with the silicomolybdate complex.

(f) The time required for full formation of the blue colour varies a little with the amount of silicon being determined. With less than about 50 $\mu\text{g-at/liter}$ 1 hr is sufficient. For amounts exceeding 75–100 $\mu\text{g-at/liter}$, however, only some 90–95% of the silicomolybdate complex may be reduced in 60 min so for assurance at least 3 hr should be allowed. A very slight increase (1–2%) may be recorded in the next 12–24 hr but the effect can be neglected. Solutions are, for all practical purposes, stable for 6 hr.

(g) The dependence of extinction on salinity is discussed in Section H below.

(h) Unless the absorptiometer is sensitive to the near infrared a marked reduction in the sensitivity of this method can be expected. The effect is not serious for wavelengths exceeding 6500 Å but a slight deviation from Beer's law may necessitate the use of calibration curves.

G. DETERMINATION OF BLANK

The blank correction for distilled water stored in polyethylene may be considered negligible and a satisfactory blank for the reagents is obtained by using distilled water to replace the sea water.

Carry out the method exactly as described in Section F, paragraphs 1–3 inclusive, using 25 ml of distilled water in place of the seawater sample. This blank extinction should not exceed about 0.01 on a 1-cm cell or 0.1 on a 10-cm cell and should be measured for each batch of reagents and checked at weekly intervals

during a cruise. If 10-cm cells are used the blank should be determined, in duplicate, with each batch of samples.

H. CALIBRATION

1. STANDARD SILICATE SOLUTION

Dried sodium silicofluoride, Na_2SiF_6 , contains within a per cent or two of the theoretical silica content and forms a very convenient standard. Weigh out 0.960 g of fine powder (deliberately a slight excess over the theoretical) crush any lumps and dissolve the salt by stirring it with 50–100 ml of water in a plastic beaker using a nickel spatula. Transfer the solution to a 1000-ml measuring flask, rinse the beaker well, and make the volume to the mark. Mix and transfer the solution to a polyethylene bottle for storage. The solution picks up silica rapidly from glass and should not be kept in the measuring flask for more than a few minutes. The solution is stable indefinitely, which is a great advantage over most standards consisting of sodium silicate.

$$1 \text{ ml} \equiv 5 \text{ } \mu\text{g-at Si}$$

Dilute 10 ml of this solution to 500 ml with synthetic sea water (*see 2 below*). Use this solution at once for calibration purposes as its reactive silicate content commences to decrease in a few hours because of polymerization.

$$1 \text{ ml} \equiv 0.1 \text{ } \mu\text{g-at Si}$$

$$1 \text{ ml} \equiv 4 \text{ } \mu\text{g-at Si/liter in 25 ml of seawater sample}$$

2. SYNTHETIC SEA WATER

Dissolve 25 g of analytical reagent quality sodium chloride and 8 g of magnesium sulphate heptahydrate, $\text{MgSO}_4 \cdot 7\text{H}_2\text{O}$, in each liter of distilled water. The water is equivalent, for analytical purposes, to sea water of salinity 28‰. This solution is best made up in 5- to 20-liter quantities at a time and *must* be stored in a polyethylene container. The silicon content of this solution should not exceed 1 or 2 $\mu\text{g-at/liter}$.

3. PROCEDURE

Carry out the silicon determination as described in Section F, above (paragraphs 1–3) using 25.0 ml of the dilute silicon standard instead of a seawater sample. Determine the extinction of four such standards and of two blanks made with synthetic sea water. A reagent blank is unnecessary. Measure the extinction in a 1-cm cell after allowing 3 hr for full colour development (*see Note f*).

Calculate the factor $F_{(1 \text{ cm})}$ from the expression:

$$F_{(1 \text{ cm})} = \frac{100}{E_s - E_b}$$

where E_s is the mean extinction of the four standards and E_b is the mean extinction of the two blanks. The value for $F_{(1 \text{ cm})}$ should not change and requires checking only infrequently at the discretion of the analyst. The value should be very close to 100. If a 10-cm cell is used, for the most precise estimate of low amounts of

silicate (less than about 12 $\mu\text{g-at Si/liter}$), the factor $F_{(10 \text{ cm})}$ may be assumed to be equal to $0.1 \times F_{(1 \text{ cm})}$.

Note: The factor F is a function of the salinity of seawater samples. Between salinities 25 and 35‰ the variation is less than 3% and may be neglected. The factor F_s at a salinity S ‰ is related to the factor, F , obtained as described above, by the approximate formula:

$$F_s = \frac{F \times (1 + 0.003 S)}{1.08}$$

This correction should be used for the most precise work when the salinity varies by more than about 10‰ from a value of 28‰. The factor for pure water (zero salinity) is thus some 8% less than the value obtained by the present method using synthetic sea water.

II.6. DETERMINATION OF REACTIVE NITRATE

INTRODUCTION

Since publication of the first edition of this manual several new procedures have been proposed for the determination of nitrate in sea water. The method based on the work of Mullin and Riley (*Anal. Chim. Acta*, 12: 464, 1955), previously described in the first edition has proven moderately satisfactory but a lengthy reduction period and sensitivity to motion are serious disadvantages. The latter we now believe is caused by the presence of air above the solution during reduction and can be minimized by carrying out the reduction in a small closed bottle of some 60-ml capacity rather than in the recommended 125-ml Erlenmeyer flasks.

The method of Chow and Johnson (*Anal. Chim. Acta*, 27: 441, 1962) based on a zinc dust reduction, has the disadvantage that it involves a magnetically stirred solution in an ice-bath followed by filtration. This is neither cheap nor convenient when handling many samples at sea. The rapid and elegant procedure described by Armstrong (*Anal. Chem.*, 35: 1292, 1963) lacks sensitivity, can be troublesome in waters of high "humic acid" content and involves unpleasant concentrations of sulphuric acid. This method, however, is ideal for determinations on culture solutions containing high concentrations of nitrate, especially when only small volumes of solution are available.

The following procedure is based on a method by Morris and Riley (*Anal. Chim. Acta*, 29: 272, 1963) with some modifications. At the suggestion of Grasshoff (*Kiel. Meeresforsch.*, 20: 5, 1964) we use ammonium chloride. A cadmium-mercury column has been replaced by a cadmium-copper column based on the work of Wood, Armstrong and Richards (*J. Marine biol. Assoc. U.K.*, 47: 25, 1967), although we have had trouble with the use of EDTA suggested by these workers and have reverted to ammonium chloride as an activator. Reduction of nitrate to nitrite is nearly complete and the method described below is probably as sensitive as is practicable by a routine spectrophotometric procedure.

METHOD

A. CAPABILITIES

Range: 0.05–45 $\mu\text{g-at/liter}$

1. PRECISION AT THE 20 $\mu\text{G-AT/LITER}$ LEVEL

The correct value lies in the range:

Mean of n determinations $\pm 0.50/n^{\frac{1}{2}}$ $\mu\text{g-at/liter}$ (using 1-cm cells).

2. PRECISION AT THE 1 $\mu\text{G-AT/LITER}$ LEVEL

The correct value lies in the range:

Mean of n determinations $\pm 0.05/n^{\frac{1}{2}}$ $\mu\text{g-at/liter}$ (using 10-cm cells).

3. LIMIT OF DETECTION

The smallest amount of nitrate nitrogen that can be detected with certainty is about 0.05 $\mu\text{g-at/liter}$ using 10-cm cells.

B. OUTLINE OF METHOD

The nitrate in sea water is reduced almost quantitatively to nitrite when a sample is run through a column containing cadmium filings loosely coated with metallic copper. The nitrite thus produced is determined by diazotizing with sulphanilamide and coupling with *N*-(1-naphthyl)-ethylenediamine to form a highly coloured azo dye the extinction of which is measured. A correction may be made for any nitrite initially present in the sample.

C. SPECIAL APPARATUS AND EQUIPMENT

The reduction columns may be conveniently prepared by joining end-to-end three pieces of glass tubing, viz: 10 cm of 5-cm internal diameter tube on to 30 cm of tubing 10 mm in internal diameter (which is to contain the metal filings, *see* Sect. E *below*) which in turn is joined to 35 cm of a tube 2 mm in diameter. The last tube is bent just below this join into a U so that it runs up parallel to the 10-mm diam tube and then its end is bent over to form an inverted U syphon. This last bend should be just level with the top of the 10-mm diam tube when the assembly is held upright to form a column. With this arrangement, liquid placed in the top reservoir tube should flow out of the system and stop when the level of liquid is such that it just covers the metal filings (*see* below). Place the reduction columns inside large glass or plastic cylinders (for protection) and fix to the outside of these a small cylinder of glass, drawn to a tube at one end and closed by a rubber tube and pinchclip. This cylinder should hold about 75 ml and be arranged under the exits of the reduction columns to collect effluents. Mark the cylinder at 40 and at 50 ml.

50-ml graduated cylinders.

125-ml Erlenmeyer flasks. These should be kept grease-free so that the minimum amount of liquid is retained when the flasks are drained dry.

D. SAMPLING PROCEDURE AND SAMPLE STORAGE

Sample (100 ± 2 ml) should be measured from sea-sampling bottles by a 100-ml measuring cylinder and placed in a 125-ml Erlenmeyer flask. Samples are stable for several hours cold and *in the dark* but the analysis should not be delayed for more than about 12 hr. If greater delays are unavoidable the samples should be frozen to -20 C in a deep-freezer where no detectable changes should occur for many weeks. Unless the number of samples is large it may be desirable to store samples at sea in this fashion and return them to a shore-base laboratory for analysis.

E. SPECIAL REAGENTS

1. CONCENTRATED AMMONIUM CHLORIDE SOLUTION

Dissolve 125 g of analytical reagent quality ammonium chloride in 500 ml of distilled water and store in a glass or plastic bottle.

2. DILUTE AMMONIUM CHLORIDE SOLUTION

Dilute 50 ml of concentrated ammonium chloride solution to 2000 ml with distilled water. Store the solution in a glass or plastic bottle.

3. CADMIUM-COPPER FILINGS

Melt cadmium metal (99.9% purity is satisfactory) in a 18 × 150 mm pyrex test tube buried in dry sand and let the metal solidify. With a coarse wood rasp, file off required amount of metal and collect the fraction passing a sieve with 2-mm openings but retained on sieve with 0.5-mm openings. Stir about 100 g of filings at a time (enough for two columns) with 500 ml of a 2% w/v solution of copper sulphate pentahydrate, $\text{CuSO}_4 \cdot 5\text{H}_2\text{O}$, until all blue colour has left the solution and semi-colloidal copper particles begin to enter the supernatant liquid. Roll *very fine* copper turnings between fingers and thumb to make a small plug and push this into the bottom of a reductor column (glass wool is less satisfactory and should be used only if *very fine* copper "wool" turnings cannot be obtained). Fill the column with dilute ammonium chloride solution, or the supernatant liquor from the preparation of cadmium-copper turnings above, and pour in sufficient cadmium-copper mixture to produce a column about 30-cm in length. Add the filings a little at a time, tapping the column hard after each addition to make sure that the filings are well settled. Wash the column thoroughly with dilute ammonium chloride solution. The flow rate must be such that 100 ml of solution takes between 8 and 12 min to flow completely through the column. If the flow-time is less than 8 min, slow it by restricting the outlet of the syphon or by packing more copper or glass wool at the base of the column. If the flow-time exceeds 12 min loosen the packing at the base of the column. Finally add a small plug of copper "wool" to the top of the column to prevent cadmium filings being washed into the top chamber when solutions are added to the column. When not in use columns must be left with the metal filings *completely* covered by dilute ammonium chloride solution. When the efficiency of reduction is suspect (*see F below*) columns should be emptied into a beaker and the filings from four columns should be washed by stirring vigorously with 300 ml of 5% v/v hydrochloric acid solution, decanting the acid and repeating the procedure once more. Finally wash the metal with 200–300 ml portions of distilled water until the wash is no longer acid ($\text{pH} > 5$) and then decant the liquid to leave the metal as dry as possible. Retreat the metal with copper sulphate solution as described above. The regenerated cadmium-copper mixture should be sufficient for about three columns.

4. SULPHANILAMIDE SOLUTION

Dissolve 5 g of sulphanilamide in a mixture of 50 ml of concentrated hydrochloric acid (sp gr 1.18) and about 300 ml of distilled water. Dilute to 500 ml with water. The solution is stable for many months.

5. N-(1-NAPHTHYL)-ETHYLENEDIAMINE DIHYDROCHLORIDE SOLUTION

Dissolve 0.50 g of the dihydrochloride in 500 ml of distilled water. Store the solution in a dark bottle. The solution should be renewed once a month or directly a strong brown colouration develops.

F. EXPERIMENTAL

PROCEDURE

1. Add 2.0 ml of concentrated ammonium chloride to the sample in the

Erlenmeyer flask (Note *a*). Mix the solution and pour about 5 ml onto the top of the column and allow it to pass through (Note *b*).

2. Add the remainder of the sample to the column and place the drained Erlenmeyer flask under the collection tube (Sect. C, *above*). When 40 ml has passed through the column, drain the collection tube into the flask, rinse the flask with this effluent, drain it and replace beneath the collection tube (Note *c*).

3. Collect a further 50 ml in the collection tube and rapidly empty it into the Erlenmeyer flask (Note *d*). The column will not be quite empty and should then be allowed to drain until flow ceases (Note *e*).

4. As soon as possible after reduction add 1.0 ml of sulphanilamide solution from an automatic pipette (Note *f*). Allow the reagent to react for a period greater than 2 min but not exceeding 8 min (Note *g*). Add 1.0 ml of naphthylethylenediamine solution and mix immediately. Between 10 min and 2 hr afterwards measure the extinction of the solution in a 1-cm cell against distilled water (Note *h*) using a wavelength of 5430 Å. If the extinction is greater than about 1.25 (*ca.* 30 µg-at N/liter) measure in a 0.5-cm cell, or pipette 25.0 ml of solution into a clean dry flask and add 25.0 ml of distilled water. Mix and remeasure the extinction and double this value for use in the formula below. If the extinction value is less than 0.1 in a 1-cm cell repeat the reading using a 10-cm cell and use the latter value for calculation purposes. For extinctions between 0.1 and 0.2 in a 1-cm cell, measurement in a 5-cm cell may be found convenient. Unless adjacent samples are known to have extinction values within about 25% of each other the absorptiometer cell should be rinsed with each new solution before filling.

5. Correct the observed extinction by that of a reagent blank (using 1-, 5-, or 10-cm cells as appropriate) obtained as described in Section G. Calculate the nitrate present from the expression:

$$\mu\text{g-at N/liter} = (\text{corrected extinction} \times F) - 0.95 C$$

where *C* is the concentration of nitrite present in the sample in µg-at N/liter. (Note *i* and Note *j*.)

NOTES

(*a*) Continual use of the column leads to deactivation, presumably because of the coating of metal particles by hydroxide or carbonate. The slight acidification of the sample by the addition of ammonium chloride greatly slows the deactivation process and a well-made column should be capable of reducing at least 100 samples. The volume of the samples is not critical up to 5 ml.

(*b*) This small preliminary addition ensures that the liquid in the top part of the column has the composition of the sample. When the bulk of the sample is then added and some of the interstitial liquid in the top of the column gets mixed into the sample no error results. Otherwise if a sample were to follow, say, a blank, some dilutions could occur. This precaution is only necessary for work of the highest accuracy when the concentration of nitrate in consecutive samples varies greatly.

(*c*) The passage of a full 40 ml has been found necessary to flush the column completely from the preceding sample although (Note *b*) this precaution is only important when concentrations vary greatly from sample to sample. A maximum of 8–10 columns can be handled conveniently at one time and, if prepared properly, their drainage times should be very similar.

The operator must learn to judge the necessary short delay between adding samples to each column in order that there should be time for rejecting the first aliquot of effluent.

(d) This 50-ml volume is not critical to a few milliliters and flasks need not be drained completely of the column-washings before collecting this fraction. Under the above conditions reduction is about 93% complete and temperature variations between 10 and 35 C have no effect.

(e) There is no need to wash columns between samples, but if the columns are not to be reused for 1–2 hr or longer 50 ml of dilute ammonium chloride should be poured into the top and allowed to pass through the system. The columns must be stored completely covered by liquid.

(f) Reduced nitrite solutions are probably stable for several hours but for safety, especially in hot weather, the analysis should not be delayed. The method is now identical with II.7.

(g) Temperature is not critical at this stage provided that it falls in the range 15–30 C. The diazotizing reaction requires 2 min for completion but undesirable side reactions and decomposition become significant after about 10 min.

(h) Complete colour development requires 10 min. The colour is then stable for at least 2 hr.

(i) With good columns nitrite is reduced to the extent of 5% so that a correction of 0.95 times the nitrite concentration of the sample (II.7) is made. With deactivated columns this fraction increases, becomes erratic, and can exceed 20%.

(j) Amounts of sulphide of up to 2 mg S²⁻/liter are said not to interfere with this method although the repeated analysis of such water will deactivate columns by the production of cadmium sulphide.

G. DETERMINATION OF BLANK

1. CELL-TO-CELL BLANKS

When both sample and distilled water cells are filled with distilled water the extinction of one against the other should be 0.000. Slight optical defects may produce a slightly positive or negative value. The water in the distilled water cell should be changed every day as marked turbidities can result even in distilled water if it remains in the cell for too long.

2. REAGENT BLANKS

The blank from reagents is barely significant when working with 1-cm cells but should be checked occasionally. It assumes considerable importance when a 10-cm cell is used. Ordinarily distilled water should be satisfactory but may contain an appreciable quantity of nitrate so, for use in the determination of reagent blanks when small amounts of nitrate are being determined, the distilled water should be redistilled from a little alkaline permanganate, rejecting the first few milliliters of distillate. Such water is assumed to contain no nitrate.

Carry out the method exactly as described in Section F paragraphs 1–4 using the 1-, 5-, or 10-cm cells that are appropriate. Add the concentrated ammonium chloride solution to 100 ml of redistilled water in a clean Erlenmeyer flask and use a column previously flushed with at least 50 ml of dilute ammonium chloride solution just before use. The blank extinction corrected by any cell-to-cell blank should not exceed about 0.1 using a 10-cm cell.

3. TURBIDITY BLANK

If the nitrate is sufficiently low to warrant the use of a 10-cm cell a check should be kept on turbidity and samples must be filtered before analysis if the turbidity extinction is appreciable.

H. CALIBRATION

As there is a slight salt effect in this method, calibration should be carried out using synthetic sea water or natural sea water with a nitrate concentration less than 1 $\mu\text{g-at N/liter}$. When analyzing for very small concentrations of nitrate (say less than 0.5 $\mu\text{g-at N/liter}$) the factor may be determined on "spiked" sea water but evidence at the moment points to this being unnecessary. The concentration-extinction relationship is strictly linear and the factor need therefore be obtained at only one level of nitrate concentration. As a safeguard against column deactivation a standard should be put through each column at the commencement of each day's work. There should generally be no significant difference between the factors obtained for each column but the accumulative mean for each one can be used, if desired, to minimize any errors that would arise should there be slight differences.

1. SYNTHETIC SEA WATER

Dissolve 310 g of analytical reagent quality sodium chloride, NaCl , 100 g of analytical reagent quality magnesium sulphate, $\text{MgSO}_4 \cdot 7\text{H}_2\text{O}$, and 0.50 g of sodium bicarbonate, $\text{NaHCO}_3 \cdot \text{H}_2\text{O}$ in 10 liters of distilled water.

2. STANDARD NITRATE SOLUTION

Dissolve 1.02 g of analytical reagent quality potassium nitrate, KNO_3 , in 1000 ml of distilled water. The solution is stable indefinitely in the absence of evaporation.

$$1 \text{ ml} \equiv 10.0 \mu\text{g-at nitrogen}$$

Dilute 4.00 ml of this solution to 2000 ml with synthetic sea water. This solution should be stored in a dark bottle and prepared fresh immediately before use.

$$\text{Concentration} = 20 \mu\text{g-at N/liter}$$

3. PROCEDURE

Add about 110 ml of this dilute standard solution to clean dry 125-ml Erlenmeyer flasks and carry out the determination exactly as described in Section F, paragraphs 1-4. Measure the extinction in a 1-cm cell. Perform the experiment *initially* in triplicate for each column and correct the mean of the three extinctions thus obtained by the blank extinction. Subsequent daily checks need only be in the form of one determination for each column.

Calculate the factor F from the expression:

$$F = \frac{20.0}{E}$$

where E is the mean extinction of the three values for each column corrected for a blank. F should have a value near to 25 when a spectrophotometer is employed.

II.7. DETERMINATION OF REACTIVE NITRITE

INTRODUCTION

There are several methods for the determination of nitrite in water, based on a classical Griess reaction, where nitrous acid is converted to a highly coloured "azo" dye. We have chosen the method of Shinn (*Ind. Eng. Chem. [Anal. Edition]*, 13: 33, 1941), as applied to sea water by Bendschneider and Robinson (*J. Marine Res.*, 11: 87, 1952), because it is probably the most sensitive and trouble-free application of this reaction so far described.

METHOD

A. CAPABILITIES

Range: 0.01–2.5 $\mu\text{g-at/liter}$

1. PRECISION AT THE 1 $\mu\text{G-AT/LITER}$ LEVEL

The correct value lies in the range:

Mean of n determinations $\pm 0.032/n^{1/2}$ $\mu\text{g-at/liter}$.

2. PRECISION AT THE 0.3 $\mu\text{G-AT/LITER}$ LEVEL

The correct value lies in the range:

Mean of n determinations $\pm 0.023/n^{1/2}$ $\mu\text{g-at/liter}$.

3. LIMIT OF DETECTION

The smallest amount of nitrite nitrogen that can be detected with certainty is 0.01 $\mu\text{g-at/liter}$.

Reject duplicate determinations if the extinction values differ

- by: more than 0.03 in the extinction range 0.5–1.0,
more than 0.02 in the extinction range 0.1–0.5,
or more than 0.005 in the extinction range 0.03–0.1.

If the duplicate extinction values differ by less than the above limits take a mean value.

B. OUTLINE OF METHOD

The nitrite in the sea water is allowed to react with sulphanilamide in an acid solution. The resulting diazo compound reacts with *N*-(1-naphthyl)-ethylenediamine and forms a highly coloured azo dye, the extinction of which is measured using 10-cm cells.

C. SPECIAL APPARATUS AND EQUIPMENT

125-ml Erlenmeyer flasks. These should be rinsed with distilled water and drained dry but no special cleaning treatment is indicated.

D. SAMPLING PROCEDURE AND SAMPLE STORAGE

The 50-ml measuring cylinder and 125-ml Erlenmeyer flasks used for this determination should be rinsed twice with the sample, and drained by inverting and shaking. Then 50 ml of sample is measured into a flask. Samples are stable in

subdued light for many hours at room temperature but the analysis should not be delayed for more than about 5–10 hr. If greater delays are unavoidable the samples should be frozen but prolonged storage is not recommended. Withdraw a separate sample of about 30 ml for turbidity measurement for work of the highest precision in inshore areas.

E. SPECIAL REAGENTS

1. SULPHANILAMIDE SOLUTION

Prepare as described in Part II.6,E.4.

2. N-(1-NAPHTHYL)-ETHYLENEDIAMINE DIHYDROCHLORIDE SOLUTION

Prepare as described in Part II.6,E.5.

F. EXPERIMENTAL

PROCEDURE

1. Measure the extinction of samples to obtain the turbidity corrections described in Section G.3.

2. Add 1.0 ml of sulphaniamide solution from an automatic pipette to each sample (50 ml in a 125-ml flask), mix, and allow the reagent to react for between 2 and 8 min (Notes *a* and *b*).

3. Add 1.0 ml of naphthylethylenediamine solution and mix immediately. Between 10 min and 2 hr afterwards measure the extinction of the solution in a 10-cm cell against distilled water (Note *c*). A wavelength of 5430 Å should be used. If a filter-type absorptiometer is used choose a filter having a peak transmission as near 5400 Å as possible. Unless adjacent samples are known to have extinction values within about 25% of each other, the absorptiometer cell should be rinsed with each new solution before filling.

4. Correct the measured extinction by subtracting both turbidity and reagent blanks (Sect. G). Calculate the nitrite-nitrogen concentration in microgram-atoms of nitrogen per liter ($\mu\text{g-at N/liter}$) from the expression:

$$\mu\text{g-at N/liter} = \text{corrected extinction} \times F$$

where F is a factor obtained as described in Section H below. Report results to three significant figures. Numerous compounds can interfere with this method but none of them will be present in significant amounts in ocean, inshore, or estuarine waters unless excessive pollution by land drainage is encountered.

NOTES

(*a*) This method is not appreciably affected by salinity, small changes in reagent concentration and volume, or by temperature. The temperature, however, should be within the range of about 15–25 C. The exact volume of sample is not critical but should lie between 45 and 55 ml.

(*b*) The diazotising reaction requires 2 min for completion, but undesirable side reactions and decomposition become significant after about 10 min.

(*c*) Ten minutes is required for complete colour development. The colour is stable for at least 2 hr but slowly fades thereafter. A 2-hr maximum is a safe limit and no great error will occur for 1 or 2 hr after that if solutions are stored out of direct sunlight.

G. DETERMINATION OF BLANK

1. CELL-TO-CELL BLANKS

See, for example, Part II.2.I,G.1.

2. REAGENT BLANKS

Carry out the method exactly as described in Section F, paragraphs 2 and 3, using distilled water in place of sea water. Correct the resulting extinction for the cell-to-cell blank. The reagent blank should not exceed 0.03. The origin of this blank is obscure. It appears to arise mainly when both reagents are mixed, and changes somewhat from day to day. It should be determined (mean of duplicates) for each batch of samples.

3. SEAWATER TURBIDITY BLANKS

In turbid inshore waters these may become a very appreciable fraction of the total extinction, which rarely exceeds 0.3 in nitrite determinations. Turbidity blanks should be determined on the surface and 10-m samples of each cast. Measure at progressively greater depths until the value becomes appreciably constant. This value (generally less than 0.01 at below 25 m in offshore waters) is then roughly equal to the cell-to-cell blank (Sect. G.1 *above*) and may even be slightly negative. Turbidity blanks should be measured on separate 30-ml samples of the sea water to which 1 ml of sulphanilamide reagent has been added.

H. CALIBRATION

1. STANDARD NITRITE SOLUTION

Anhydrous analytical reagent quality sodium nitrite, NaNO_2 , is sufficiently pure for calibration purposes. For surety a little of the salt should be dried at 110 C for 1 hr. Dissolve 0.345 g in 1000 ml of distilled water. Store the solution in a dark bottle with 1 ml of chloroform as a preservative. The solution is stable for at least 1-2 months.

$$1 \text{ ml} \equiv 5 \mu\text{g-at N}$$

Dilute 10.0 ml of this solution to 1000 ml with distilled water and *use the same day*.

$$1 \text{ ml} \equiv 5 \times 10^{-2} \mu\text{g-at N}$$

$$1 \text{ ml} \equiv 1.0 \mu\text{g-at N/liter in 50 ml of seawater sample}$$

2. PROCEDURE

Prepare four standard solutions consisting of 2.00 ml of the dilute nitrite solution (measured with a 2.00-ml graduated pipette) made to a volume of 50 ml in a graduated flask or 50-ml measuring cylinder. Transfer the solutions to four dry 125-ml Erlenmeyer flasks and place 50 ml of distilled water in two more flasks to act as blanks. Carry out the nitrite determination as described in Section F, paragraphs 2-3.

Calculate the factor F from the expression:

$$F = \frac{2.00}{E_s - E_b}$$

where E_s is the mean extinction of the four standards and E_b is the mean extinction of the two blanks (*not* corrected for cell-to-cell blanks).

Note: The factor F does not vary with time or over a wide range of experimental conditions and is near 2.1 when a spectrophotometer is employed.

II.8. DETERMINATION OF AMMONIA PLUS AMINO ACIDS

INTRODUCTION

In the interest of speed and simplicity and to minimize the chance of contamination, a determination of ammonia in sea water should be by a direct procedure rather than by distillation. The classical "direct methods" of Witting (Wirth and Robinson, Ind. Eng. Chem. [Anal. Edition], 5: 293, 1933) or of Wattenberg (Rappt. Proces-Verbaux Reunions, Conseil Perm. Intern. Exploration Mer, 53: 108, 1929) are tedious and time-consuming and have very poor sensitivity. Most of the above criticisms are met in the extraction method proposed by Kruse and Mellon (Anal. Chem., 25: 1188, 1953) and applied by one of us to sea water (Strickland and Austin, J. Conseil, Conseil Perm. Intern. Exploration Mer, 24: 446, 1959). However, this method is tedious and open to criticism when used with very low ammonia concentrations. The following method has been adopted (L. Solórzano, unpublished work) from a technique suggested by Richards and Kletsch (Sugawara Festival Volume, Maruza Co. Ltd. Tokyo, p. 65-81, 1964) modified for use with an Auto-analyzer^(R). There is some interference from amino acids but when this is not important the following method should be used.

METHOD

A. CAPABILITIES

Range: 0.1-10 µg-at/liter

1. PRECISION AT THE 3 µG-AT/LITER LEVEL

The correct value lies in the range:

$$\text{Mean of } n \text{ determinations } \pm 0.25/n^{\frac{1}{2}} \text{ µg-at/liter.}$$

2. PRECISION AT THE 1.0 µG-AT/LITER LEVEL

The correct value lies in the range:

$$\text{Mean of } n \text{ determinations } \pm 0.11/n^{\frac{1}{2}} \text{ µg-at/liter.}$$

3. LIMIT OF DETECTION

The smallest quantity of ammonia nitrogen that can be detected with certainty by a single determination is about 0.1 µg-at/liter.

B. OUTLINE OF METHOD

The ammonia in sea water is oxidized to nitrite by hypochlorite in alkaline medium, and the excess oxidant destroyed by the addition of arsenite. The nitrite is determined as described in Section II.7.

C. SPECIAL APPARATUS AND EQUIPMENT

125-ml Erlenmeyer flasks. These must be cleaned with warm hydrochloric acid 10%, rinsed copiously with distilled water and drained immediately before use.

D. SAMPLING PROCEDURE AND SAMPLE STORAGE

Temporary storage of sea water prior to analysis appears to be satisfactory in either glass or polyethylene but the analysis should not be delayed for more than 1-2 hr at the most. If longer storage periods are necessary freeze the samples solid in a deep-freeze. There are indications that, even with refrigeration, losses or gains may be significant after more than a few days. Although more evidence is required it would seem desirable not to store samples.

E. SPECIAL REAGENTS

1. DE-IONIZED WATER.

This should be used for making solutions, for the determination of blanks and for standardizations. Ordinary distilled water cannot be trusted for these purposes.

Remove the ammonia from distilled water by passing it through a small column (e.g. 30 cm long by 1-2 cm internal diameter) of cation exchange resin in the hydrogen form just before use and store the water in a tightly stoppered glass flask. Failure to observe this precaution will eventually lead to trouble in almost any laboratory.

2. ALKALINE SODIUM CITRATE.

Dissolve 700 g of sodium citrate and 40 g of sodium hydroxide in 2000 ml of de-ionized water and store the solution in a tightly stoppered polyethylene bottle. The solution should be stable for many months.

3. SODIUM HYPOCHLORITE SOLUTION.

Use a solution of commercial hypochlorite (e.g. Chlorox) which should be about 1.5N. The solution decomposes slowly and its strength should be checked periodically. Dissolve 12.5 g of good-quality sodium thiosulphate, $\text{Na}_2\text{S}_2\text{O}_3 \cdot 5\text{H}_2\text{O}$, in 500 ml of water. Add a few crystals (ca. 2 g) of potassium iodide, KI, to about 50 ml of water in a small flask and pipette in 1.0 ml of hypochlorite solution.

Add 5-10 drops of concentrated hydrochloric acid and titrate the liberated iodine with the thiosulphate solution until no yellow color remains. Discard the hypochlorite when less than 12 ml of thiosulphate is used.

4. SODIUM ARSENITE SOLUTION.

Dissolve 20 g of analytical reagent sodium meta-arsenite Na_2AsO_2 in 1000 ml of de-ionized water. Store in a well-stoppered polyethylene bottle. The solution is stable indefinitely.

5. SODIUM BROMIDE SOLUTION.

Dissolve 1.5 g analytical reagent quality sodium bromide, NaBr, in 250 ml of de-ionized water.

6. OXIDIZING REAGENT.

Add 0.5 ml of sodium hypochlorite solution to 100 ml of alkaline sodium citrate. This solution should be prepared immediately before use and not stored for more than 3 hours. Prepare multiples of the above solutions according to the number of samples to be analysed per batch (10 ml of oxidizing reagent per sample).

7. ACIDIFYING SOLUTION.

Dilute analytical reagent quality concentrated hydrochloric acid with an equal volume of de-ionized water.

Add to a 125-ml Erlenmeyer flask about 50 ml of distilled water, pipette into this 10.0 ml of oxidizing agent, and add 2 ml of sodium arsenite solution. Add one or two drops of thymol blue indicator solution (0.1% solution in distilled water) and titrate the mixture carefully with the diluted hydrochloric solution until the color changes from blue to pink (ca. pH 1.7). Carry out titrations in duplicate. Titrations should agree to better than 0.1 ml of acid and the mean volume should be recorded to the nearest 0.05 ml. If x ml of acid is used (about 5-6 ml) dilute $200x$ ml of acid to exactly 2000 ml with deionized water using a measuring flask. This solution must be prepared fresh whenever a new alkaline sodium citrate solution is used.

8. SULPHANILAMIDE SOLUTION.

Prepare as described in Part II.6, E.4.

9. N-(1-NAPHTHYL)-ETHYLENEDIAMINE DIHYDROCHLORIDE SOLUTION.

F. EXPERIMENTAL

Section G2 should be consulted before commencing this determination.

PROCEDURE

1. Add 50 ml of sample to an Erlenmeyer flask from a 50 ml measuring cylinder. Add 10 ml of oxidizing reagent from a pipette, swirl the solution, and allow the flask to stand at a temperature between 20 and 25°C for 10 minutes (note a).

2. Add 2 ml of sodium arsenite solution from an automatic pipette and mix the contents of the flask (note b). Add 10 ml of acidifying solution from a pipette and mix (note c).

3. After as short an interval as possible, to lessen the chances of atmospheric contamination, add 1 ml of sulphanilamide solution from an automatic pipette. Swirl the contents of the flask. After a further 3-8 minutes add 1.0 ml of naphthylethylenediamine solution from an automatic pipette and mix immediately (note d). Between 10 min and 2 hours afterwards, measure the extinction of the solution in a 10-cm cell against distilled water at a wavelength of 5430 Å. If the extinction exceeds about 1.3 (rarely) measure the extinction with a 5-cm cell and double the reading so obtained. Unless adjacent samples are known to have extinction values within about 25% of each other, the absorptiometer cell should be rinsed with each new solution before filling.

4. Correct the measured extinction by that of a reagent blank (Sect. G) and calculate the ammonia-nitrogen concentration (plus some amino-acid nitrogen (see note e) from the expression:

$$\mu\text{g-at N/liter} = F \left[E - \frac{0.70 \times C}{F'} \right]$$

where E is the corrected extinction, F is the factor obtained as described in Section H below, C is the concentration of nitrite in the same sea water, expressed in $\mu\text{g-at N/liter}$, obtained by a separate analysis as described in Part II.7. F' may be assumed to be equal to 2.1 with little error if a spectrophotometer is used (note f).

NOTES

(a) The time required for maximum oxidation depends on salinity and temperature. The oxidation requires a full ten minutes after which stable results are obtained. The sensitivity in distilled water is slightly less than in sea water but the difference is sufficiently small that it can be neglected when making a 'blank' determination. Bromide acts as a catalyst and must be added to distilled water or synthetic bromide-free sea water.

(b) Arsenite is added to destroy excess hypochlorite without reducing nitrite. The reaction is very rapid but for safety about 2 minutes should be allowed for the reaction to be completed before adding the acidifying solution.

(c) If sulphanimide is present at this stage, as in the original Richards and Kletsch method and the version of this method given in the 2nd Edition of Bulletin 125 (Fish. Res. Bd. Canada, 1965), an appreciable fraction of nitrite is decomposed and the method becomes less sensitive and more erratic.

(d) The determination is from now on the same as that for nitrite described in Part II.7. except that both sample volume and acidity are rather greater.

(e) The interference from urea and amino acids is less than in the original Richards and Kletsch method but may be up to 40 percent of the amino nitrogen of some compounds.

(f) Any nitrite initially present in the sample is unchanged by the analytical procedure, so a correction for its presence can be made in the manner shown. In this calculation allowance is made for the fact that the sample is diluted from 52 to 74 ml by reagents before extinction measurements are made and that only a fraction of the ammonia is converted to nitrite. This correction can be quite significant in water containing relatively large amounts of nitrite but little ammonia.

G. DETERMINATION OF BLANK

1. REAGENT BLANK.

Carry out the method exactly as described in Section F, paragraphs 1-3, using 50 ml of freshly de-ionized water and 1 ml of sodium bromide solution to act as a catalyst. A blank determination in triplicate must be carried out with each batch of samples being analysed. Blank extinctions using a 10-cm cell should not exceed 0.15.

2. PRECAUTIONS TO REDUCE CONTAMINATION.

The greatest care is necessary to prevent the contamination of reagents and samples by ammonia (carried as gas or particles of ammonium salts) in the laboratory. Solutions should be kept in tightly stoppered bottles, except when in use, and samples should be stored in well-stoppered containers until the analysis commences. Under no circumstances must a bottle of ammonium hydroxide be opened in the laboratory, for however brief a period, whilst analyses for ammonia are being carried out. All glassware must be washed initially by dilute acid and rinsed very thoroughly with distilled water immediately prior to every use. Ordinary distilled water is satisfactory for this rinsing.

H. CALIBRATION

Carry out the calibration using filtered sea water.

1. STANDARD AMMONIA SOLUTION.

Dissolve 0.100 g of analytical reagent quality ammonium sulphate in 1000 ml of distilled water. Add 1 ml of chloroform and store sheltered from strong light. The solution is stable for many months if well stoppered.

$$1 \text{ ml} \equiv 1.5 \text{ } \mu\text{g-at N}$$

Pipette 1.00 ml of this solution into a 500-ml flask and complete with sea water to the mark. The resulting ammonium concentration is equivalent to 3.0 $\mu\text{g-at N}$ /liter.

2. PROCEDURE.

Measure out 50-ml portions of this dilute ammonia solution into each of four clean 125-ml Erlenmeyer flasks and take two 50 ml portions of the same sea water that was used to make the diluted standard solution into two additional clean 125-ml Erlenmeyer flasks. Carry out the determinations on all, exactly as described in Section F, paragraphs 1-3.

Evaluate the factor F from the expression:

$$F = \frac{3.0}{E_s - E_b}$$

where E_s is the mean extinction of the standards and E_b is the mean extinction of the blanks. The value for F should be near 4.5.

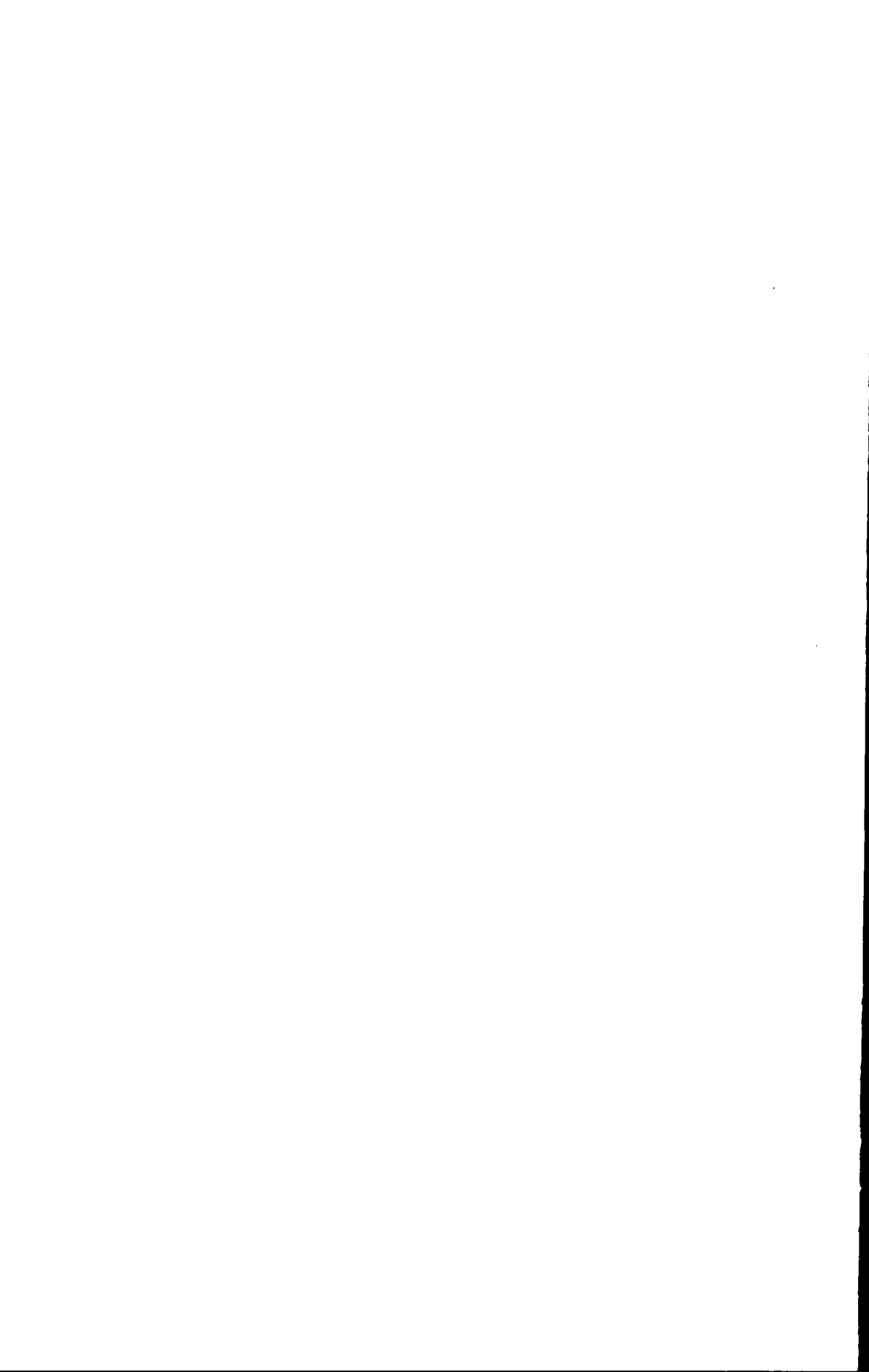

II.9. DETERMINATION OF AMMONIA

INTRODUCTION

The following method is specific for ammonia and, although not as sensitive as the procedure described in II.8., should be used when an estimate of the concentration of ammonia alone is desirable. The technique is a sensitive modification of the phenol-hypochlorite method used by many workers (e.g., Riley, *Anal. Chim. Acta.*, 9: 575, 1953; Emmet, *Naval Ship Res. and Devel. Cent. Rept.* 2570, 1968) by L. Solorzano (*Limnol. Oceanogr.* 14: 799, 1969).

METHOD

A. CAPABILITIES

Range: 0.1–10 µg-at/liter

1. PRECISION AT THE 3 µG-AT/LITER LEVEL

The correct value lies in the range:

Mean of n determinations $\pm 0.15/n$ µg-at/liter.

2. PRECISION AT THE 1.0 µG-AT/LITER LEVEL

The correct value lies in the range:

Mean of n determinations $\pm 0.10/n$ µg-at/liter.

3. LIMIT OF DETECTION

The smallest quantity of ammonia nitrogen that can be detected with certainty by a single determination is about 0.1 µg-at/liter.

Reject duplicate determinations if extinction values differ by:

more than 0.015 in the extinction range 0.1 to 0.2,

more than 0.025 in the extinction range 0.2 to 0.5.

If duplicate extinction values differ by less than the above limits, take a mean value.

B. OUTLINE OF METHOD

The sea water is treated in an alkaline citrate medium with sodium hypochlorite and phenol in the presence of sodium nitroprusside which acts as a catalyzer. The blue indophenol formed with ammonia is measured using a 10-cm cell.

C. SPECIAL APPARATUS AND EQUIPMENT

125-ml Erlenmeyer flasks. These must be rinsed copiously with distilled water and drained immediately before use.

D. SAMPLING PROCEDURE AND SAMPLE STORAGE

Temporary storage of sea water prior to analysis appears to be satisfactory in either glass or polyethylene but the analysis should not be delayed for more than 1-2 hr at the most. If longer storage periods are necessary freeze the samples solid in a deep-freeze. There are indications that, even with refrigeration, losses or gains may be significant after more than a few days. Although more evidence is required it would seem desirable not to store samples.

E. SPECIAL REAGENTS**1. DE-IONIZED WATER**

See II.8, E.1.

2. PHENOL SOLUTION

Dissolve 20 g of crystalline analytical reagent grade phenol in 200 ml of 95% v/v ethyl alcohol.

3. SODIUM NITROPRUSSIDE SOLUTION

Dissolve 1.0 g of sodium nitroprusside $\text{Na}_2 \text{Fe} (\text{CN})_5 \text{NO} \cdot 2\text{H}_2\text{O}$ in 200 ml of de-ionized water. Store in an amber bottle. The solution is stable for at least one month.

4. ALKALINE REAGENT

Dissolve 100 g of sodium citrate and 5 g of sodium hydroxide (analytical reagent grade) in 500 ml of de-ionized water. This solution is stable indefinitely.

5. SODIUM HYPOCHLORITE SOLUTION

See II.8, E.3.

6. OXIDIZING SOLUTION

Mix 100 ml of reagent 4 and 25 ml of reagent 5. Keep this solution stoppered while it is not in use. Prepare fresh every day.

F. EXPERIMENTAL

Section G.2 should be consulted before commencing this determination.

PROCEDURE

1. Add 50 ml of sample to an Erlenmeyer flask from a 50-ml measuring cylinder. Add 2 ml of phenol solution, from a pipette, swirl the solution, and then sequentially add 2 ml of sodium nitroprusside solution (Note *a*) and 5 ml of oxidizing solution (Note *b*), mixing after each addition. Allow the flask to stand at a temperature between 20 C and 27 C for 1 hour (Note *d*). The top of the flask should be covered with aluminum foil at this stage to lessen the contamination by atmospheric ammonia.

2. Read the extinction at 6400 Å in a spectrophotometer against distilled water using 10-cm cells.

3. Correct the measured extinction by that of a reagent blank (Sec. G) and calculate the ammonia-nitrogen concentration from the expression:

$$\mu\text{g-at N/liter} = F \times E$$

where E is the corrected extinction and F is a factor obtained as described in Section H below. Report results to two significant figures. There is no interference in this method from amino acids and urea (Note *e*).

NOTES

(*a*) Sodium nitroprusside in the concentrations of 0.5% is sufficient to catalyze the reaction and produce a stable and low blank. Higher concentration produces a high and unstable blank, which increases with time.

(b) The quantity and strength of sodium hypochlorite have marked effect in the reaction in sea water. With more dilute hypochlorite a correspondingly larger volume can be added but care must be taken to see that the pH (*see Note c below*) does not much exceed 9.8.

(c) The addition of reagents as indicated above gave the best results in sea water and distilled water. At higher pH values the reaction is faster but a slight blue coloration (not due to the presence of amino compounds but associated with the presence of nitro-prusside) is suppressed when working in distilled water. This results in a "false blank" and erroneously high values for the ammonia content of sea water. At the pH used in the present technique (9.8 in sea water and 10.4 in distilled water) the blue color from the nitro-prusside is formed equally in samples and blanks.

(d) The reaction requires a full 60 minutes for completion. The color produced is then stable for at least 24 hours.

(e) Urea and several amino acids (glycine, D-L Alanine, L-Arginine, D-L Histidine, L-Tyrosine, L-Lysine and L-Glutamic acid) in the concentrations of 3 $\mu\text{g-at N/l}$ in filtered sea water gave a negligible response to this treatment.

G. DETERMINATION OF BLANK

1. REAGENT BLANK

Carry out the method exactly as described in Section F. 1 and 2 above using freshly de-ionized water. Blanks extinctions using a 10-cm cell should not exceed .075.

2. PRECAUTIONS TO REDUCE CONTAMINATION

See II.8, G.2.

H. CALIBRATION

1. STANDARD AMMONIA SOLUTION

See II.8, H.1.

2. PROCEDURE

Measure out 50 ml portions of this dilute ammonia solution into each of four clean 125-ml Erlenmeyer flasks. Prepare two blank solutions with no added ammonia as described in Section G. Carry out the determinations as described in Section F. 1 and 2 above. Read the extinction after 60 minutes. Evaluate the factor F from the expression:

$$F = \frac{3.0}{E_s - E_b}$$

where E_s is the mean extinction of the standards and E_b the mean extinction of the blanks. The value for F is about 6.5 and we have found it very constant.



II.10. DETERMINATION OF UREA

INTRODUCTION

This method is specific for urea and is more precise and less difficult to master than the direct chemical method given by Newell, Morgan and Cundy (J. Mar. Biol. Ass. U.K., 47: 271. 1967). It is based on work by J. McCarthy (Limnol. Oceanogr., 15: 309. 1970), using an ammonia method described by Lucia Solórzano (Limnol. Oceanogr., 14: 799. 1969).

METHOD

A. CAPABILITIES

Range: 0.05 – 5 µg-at urea-N/liter

1. PRECISION AT THE 3 µG-AT /LITER LEVEL

The correct value lies in the range:

$$\text{Mean of } n \text{ determinations} \pm \frac{0.1}{n^{\frac{1}{2}}} \mu\text{g-at/liter.}$$

2. LIMIT OF DETECTION

The smallest quantity of urea nitrogen that can be detected with certainty by a duplicate determination is about 0.05 µg at /liter.

B. OUTLINE OF METHOD

Urea in seawater is hydrolyzed in an unbuffered solution at elevated temperature, using the enzyme urease and the resulting ammonia is estimated by spectrophotometry using a phenol hypochlorite method and a 10-cm spectrophotometer cell.

C. SPECIAL APPARATUS AND EQUIPMENT

125-ml Erlenmeyer flasks. These must be rinsed copiously with distilled water immediately before use.

Water bath at 50°C.

Cellulose dialyzer tubing (approx. 20 cm long by 3 cm diameter).

D. SAMPLING PROCEDURE AND SAMPLE STORAGE

Take as one of the earlier samples from overside bottles. Temporary storage in glass bottles appears satisfactory if filtered samples are frozen in a deep freeze and analyzed within a few weeks. Observe all the precautions outlined in II.8.G.2. for exclusion of ammonia. Although ammonia contamination prior to analysis should, theoretically, not affect results for urea it is best kept to a minimum.

E. SPECIAL REAGENTS

1. DE-IONIZED WATER

See II.8.E.1.

2. ETHYLENE DIAMINETETRAACETATE SOLUTION (EDTA)

Dissolve 50 g of the disodium salt of ethylene diaminetetraacetate in 4.5 liters of distilled water. Adjust the pH to 6.5 with a little (ca. 5% w/v) sodium hydroxide solution and dilute to 5 liters.

3. CLELAND'S REAGENT

Dissolve 0.20 g of Cleland's reagent (dithrothreitol) in 100 ml of distilled water. Store in a glass bottle and keep frozen in a deep-freezer when not in use.

4. CONCENTRATED ENZYME SOLUTION

Crude urease (preferably Worthington (URC) lyophilized) will be contaminated with ammonium salts and is best purified by dialysis.

Dissolve 0.25 g of enzyme in 45 ml of EDTA solution and pour it into a dialyzer bag suspended in a 1000-ml beaker containing about 800 ml of EDTA chilled to 5°C. Place the beaker in a refrigerator (3–6°C) and stir the solution changing the EDTA in the beaker every half day for 3 days. Remove the dialyzed enzyme solution into a glass bottle and add 50 ml of analytical reagent quality glycerol and 5 ml of Cleland's Reagent. Store the mixture at 5°C. The preparation is stable for several months if kept cold.

5. DILUTE ENZYME SOLUTION

Dilute 5.0 ml of concentrated enzyme solution to 100 ml with de-ionized water. Prepare fresh each day.

6. PHENOL SOLUTION

See II.9.E.2.

7. SODIUM NITROPRUSSIDE SOLUTION

See II.9.E.3.

8. ALKALINE REAGENT

See II.9.E.4.

9. SODIUM HYPOCHLORITE SOLUTION

See II.8.E.3.

10. OXIDIZING SOLUTION

Mix 100 ml of reagent 8 with 25 ml of reagent 9. Keep this solution stoppered while not in use. Prepare fresh every day.

F. EXPERIMENTAL

PROCEDURE

1. Add 50 ml of sample to each of four 125-ml Erlenmeyer flasks using a 50-ml measuring cylinder. Add 5.0 ml of dilute enzyme preparation from a pipette to two only of the flasks and mix the contents. Cover the mouths of all four flasks with

aluminum foil (Note *a*). Place the two flasks containing the enzyme in a water bath at 50°C for 20 minutes (Note *b*).

2. Cool the flasks to room temperature. Add 5.0 ml of dilute enzyme to the two aliquots that have not been heated (Note *c*).

3. Continue the determination of ammonia on all four flasks exactly as described in II.9.F.1. and 2. (Note *d*).

4. Read the extinction of all four flasks in a spectrophotometer against water in 10-cm cells using a wavelength of 6400 Å.

5. Calculate the urea nitrogen concentration from the expression:

$$\mu\text{g-at N/liter} = F \times (E_S - E_B)$$

where E_S is the mean extinction of the solutions in the two flasks heated with urease and E_B is the mean extinction of the solution in the unheated flasks (Note *e*). F is a factor determined as described later in Section H.

NOTES

(*a*) Foil or screw stoppers must be used to close the mouth of each flask to prevent variable atmospheric contamination from ammonia.

(*b*) The temperature is not critical to a few degrees but should not exceed 50°C. The time of 20 minutes should allow for a safety margin of at least 5 minutes for complete hydrolysis of urea by the enzyme. However, it would be wise to check each new source of enzyme or, if solutions of enzyme are kept for protracted periods, it would be wise to check complete hydrolysis with a time curve. The optimum pH for hydrolysis is a function of the ions present but is in the range 6.5 to 8.0 and does not merit the addition of buffer to normal sea water. If the method is used for highly alkaline lake waters attention should be paid to the pH and suitable adjustment made.

(*c*) The unheated aliquots act as blanks for the ammonia in the sea water sample and for any residual ammonia in the enzyme preparation. The latter should not exceed the equivalent of about 0.15 $\mu\text{g-at N/liter}$.

(*d*) The determination of ammonia should be done without delay (0.5-1 minute) after adding enzyme to the two cold blanks so that no hydrolysis of urea takes place. This is very slow at room temperature (25°C) but not negligible. It is stopped completely when the pH is elevated after adding the ammonia reagents.

(*e*) As far as is known the method is completely specific for urea. The blank determination is not a reliable estimate of any ammonia in sea water because of possible reagent contamination but ammonia determinations are conveniently carried out at the same time as urea determinations (see II.9.).

G. DETERMINATION OF BLANK

1. REAGENT BLANK

There is no reagent blank, per se, for this method as individual blanks are done for each sample along with the main determinations.

2. PRECAUTIONS TO REDUCE CONTAMINATION

See II.8.G.2. for general precautions for preventing ammonia contamination.

H. CALIBRATION

1. STANDARD UREA SOLUTION

Dissolve 0.090 g of analytical reagent quality urea in 1000 ml of distilled water. Add a few milliliters of chloroform. The solution is stable at room temperature if not contaminated but is best stored at 5°C.

$$1 \text{ ml} \equiv 3 \text{ } \mu\text{g-at urea N}$$

2. DILUTE STANDARD

Add 1.00 ml of the above solution to 1 liter of low-ammonia sea water. The concentration is then 3.0 $\mu\text{g-at urea N/liter}$.

3. PROCEDURE

Measure out three 50 ml portions of the dilute standard into clean Erlenmeyer flasks. Add to three more flasks the same sea water that was used to prepare the dilute standards but with no added urea. Carry out the determination exactly as described in Section F. 1-4.

Calculate the factor F from the expression:

$$F = \frac{3.0}{(E_S - E_B)}$$

where E_s and E_b are the mean extinctions of the triplicate standards and standard-blanks, respectively.

The value for F should be near to 6.5 and reasonably constant. Redeterminations should be made at the discretion of the analyst but are probably not often needed.

II.11. DETERMINATION OF HYDROXYLAMINE

INTRODUCTION

Hydroxylamine has a limited stability in oxygenated sea water at pH 8 and may not be sufficiently stable to coexist with oxygen even at the very low oxygen concentrations found in some areas of the Pacific ocean. However, under anaerobic conditions in the sea and in lakes, hydroxylamine is stable and may be present.

The following method is a modification of Blom's method which was used by Barnes (*J. Marine Biol. Assoc. U.K.*, 25: 109, 1941) for sea water without much success. However, the modifications used here, taken from both Drozdov and Iskandaryan (*J. Anal. Chem. USSR*, 11: 775, 1956) and Csaky (*Acta Chem. Scand.*, 2: 450, 1948) have resulted in a quick and convenient method with a suitable sensitivity for all likely marine or fresh water work (Findeiro, Solórzano and Strickland. *Limnol. Oceanog.*, 12:555, 1967).

METHOD

A. CAPABILITIES

Range: 0.015–3 $\mu\text{g-at/liter}$

1. PRECISION AT THE $1\mu\text{G-AT/LITER}$ LEVEL

The correct value lies in the range:

Mean of n determinations $\pm 0.01/n^{\frac{1}{2}}$ $\mu\text{g-at/liter}$.

2. LIMIT OF DETECTION

The smallest amount of hydroxylamine nitrogen that can be detected with certainty is about $0.015 \mu\text{g-at/liter}$.

B. OUTLINE OF METHOD

The hydroxylamine is oxidized to nitrite with an acidic iodine solution and the excess iodine destroyed by arsenite. The nitrite thus produced is determined by diazotizing sulphanilic acid and coupling with *N*-(1-naphthyl)-ethylenediamine to form a highly coloured azo dye, the extinction of which is measured. A correction is made for any nitrite initially present in the sample.

C. SPECIAL APPARATUS AND EQUIPMENT

125-ml Erlenmeyer flasks. These should be rinsed with distilled water and drained dry. No special cleaning treatment is indicated.

D. SAMPLING PROCEDURE AND SAMPLE STORAGE

Samples are not stable and analysis should not be delayed for more than a few *minutes* once air enters the water. If a longer delay is unavoidable add 0.5 ml of approximately 1N hydrochloric acid for each 100 ml of sample. The analysis can then be delayed for about 3–4 hr but no longer.

E. SPECIAL REAGENTS

1. SULPHANILIC ACID SOLUTION

Add 10 g of sulphanilic acid to 7 g of sodium acetate ($\text{CH}_3\text{COONa}\cdot 3\text{H}_2\text{O}$)

and 300 ml of glacial acetic acid dissolved in about 500 ml of distilled water. Heat the mixture to the boil for a few minutes, cool and dilute to 1 liter with water.

2. IODINE SOLUTION

Dissolve 2.6 g of iodine in 200 ml of glacial acetic acid.

3. SODIUM ARSENITE

Dissolve 2.0 g of analytical reagent quality sodium arsenite, NaAsO_2 , in 200 ml of distilled water.

4. *N*-(1-NAPHTHYL)-ETHYLENEDIAMINE SOLUTION

Prepare as described in Part II.6,E.5.

F. EXPERIMENTAL

PROCEDURE

1. Add 50 ± 2 ml of sample to a 125-ml Erlenmeyer flask using a measuring cylinder. Add 2 ml of sulphanic acid solution from an automatic pipette to each sample (Note *a*). If sulphide is present, *immediately* after adding the sulphanic acid, pass nitrogen gas vigorously through the solutions for 10–15 min until no more smell of hydrogen sulphide can be detected (Note *b*).

2. Add 1 ml of iodine solution with an automatic pipette, mix the solutions and allow the reagent to react for 3 min (Note *c*).

3. Add 1 ml of sodium arsenite solution from an automatic pipette, mix the contents of the flask and allow them to stand for 2 min (Note *d*).

4. Add 1 ml of *N*-(1-naphthyl)-ethylenediamine dihydrochloride solution from a 1 ml pipette. Between 15 min and 2 hr afterwards, measure the extinction of the solution in a 10-cm cell against distilled water at a wavelength of 5430 Å (Note *e*).

5. Correct the measured extinction by that of a reagent blank (Sect. G). Calculate the hydroxylamine present from the expression:

$$\mu\text{g-at N/liter} = \left[\text{corrected extinction} - \frac{C}{2.33} \right] \times F$$

where *F* is a factor obtained as described in Section H below and *C* is the concentration of nitrite present in the sample in $\mu\text{g-at N/liter}$ (Note *f*).

NOTES

(*a*) The method is not sensitive to variations in salinity over the range 25–35‰ or to variations in the temperature of samples over the range 15–30 C. The exact volume of sample is not very critical but should be within the range of 48–52 ml.

(*b*) Any sulphide present in anaerobic water interferes by reducing iodine and producing a precipitate of sulphur. Immediate and vigorous degassing of the acidified solutions is the most convenient method of removing the interference.

(*c*) The oxidation period of 3 min is a safe minimum time. If the period of oxidation is increased blank extinctions increase but so do sample extinctions and differences remain constant. However, there seems little point in having a period longer than 3–5 min and care should be taken to see that the time for all samples and blanks is kept the same to within 0.5 min.

(*d*) The reaction is rapid and this period is not critical but for safety should not be less than 1 min. The diazotised solution slowly decomposes and therefore should not be allowed to stand for more than about 15 min.

(e) Complete colour development requires 15 min. The colour is stable for at least 2 hr but slowly fades thereafter. A 2-hr maximum is a safe limit and no great error will occur for 1 or 2 hr after that if solutions are stored out of direct sunlight.

(f) The factor for nitrite taken through this method is 2.33 and hence a correction to the observed extinction of $\frac{C}{2.33}$ (where C is the amount of nitrite in $\mu\text{g-at/liter}$ obtained by method II.7) is necessary whenever the nitrite is a significant fraction of the hydroxylamine. As the amount of nitrite may exceed that of hydroxylamine, the factor 2.33 is important and may have to be redetermined exactly by the operator.

G. DETERMINATION OF BLANKS

1. CELL-TO-CELL BLANK

See for example, Part II,2.I,G.1.

2. REAGENT BLANK

Carry out the method exactly as described in Section F, paragraphs 1–4, using distilled water in place of sea water. Correct the resulting extinction for the cell-to-cell blank. The reagent blank should not exceed about 0.05. The small salt error on this reagent blank can be neglected.

H. CALIBRATION

1. STANDARD HYDROXYLAMINE SOLUTION

Dissolve 0.348 g of hydroxylamine hydrochloride, analytical reagent quality, ($\text{NH}_2\text{OH}\cdot\text{HCl}$), predried over silica gel for 48 hr, in about 400 ml distilled water. Add 2 ml of 1N reagent and make the solution to a volume of 1000 ml in a volumetric flask.

$$1 \text{ ml} \equiv 5 \mu\text{g-at N}$$

This solution is stable for at least one month. Dilute 5.00 ml of this solution to 1000 ml with distilled water and use the same day.

$$1 \text{ ml} \equiv 0.5 \mu\text{g-at N/liter in 50 ml of sea water}$$

2. SEA WATER

Use synthetic sea water (Part II.6,H.1) or, preferably, filtered surface sea water of salinity 25–35‰ low in nitrite.

3. PROCEDURE

Prepare four standard solutions consisting of 2.00 ml of the dilute hydroxylamine solution (measured with a 2.00 ml graduated pipette) made to a volume of 50 ml with sea water in a graduated cylinder or a volumetric flask. Transfer the solutions to four *dry* 125-ml Erlenmeyer flasks and place 50 ml of sea water in two more flasks to act as blanks. Carry out the determination immediately as described in Section F, paragraphs 1–5.

Calculate the factor F from the expression:

$$F = \frac{1.0}{E_s - E_b}$$

where E_s is the mean extinction of the four standards and E_b is the mean extinction

of the two blanks (not corrected for cell-to-cell blanks). The factor should be around 2.5, when a spectrophotometer is used.

NOTE: This method has a slight salt effect in that extinctions in distilled water are some 15% less than in sea water of salinity 35‰. The variations of salinity to be expected from sample to sample, however, would not affect results appreciably. It should be remembered that hydroxylamine is rapidly decomposed at room temperature in sea water so that if sea water is used for standardization, as above, the solutions should be prepared and sulphanilic acid added within 5 min.

II.12. DETERMINATION OF REACTIVE IRON

INTRODUCTION

The iron compounds passing through a Millipore HA filter will be arbitrarily designated as "soluble." Such compounds consist of truly soluble complexes of ferric iron and of colloidal ferric hydroxide and phosphate particles. The uncomplexed ferric ion cannot exist in measurable amounts at the *pH* of sea water and ferrous iron will not normally occur unless exceptional biological conditions have produced an anaerobic environment. As the amounts of both colloidal and complexed ferric iron are largely governed by the presence of organic matter, the "soluble" fraction of the total iron is probably a crude measure of the soluble organic material in sea water. Often not more than about half the total iron is found to be "soluble" and the fraction may be less than one tenth.

The iron compounds retained on an HA filter may consist of iron in mineral combination (sand, clay, volcanic ash, etc.), or in organic combination (in or adsorbed on plankton and detritus), or as "flocks" of ferric hydroxide and phosphate, either free or absorbed onto other particles.

There is evidence that much of the soluble iron combined as stable organic complexes may not be available for plant growth and clearly the iron in sand, clay particles, volcanic ash, etc., will be biologically unreactive for rapidly growing plant cells. On the other hand particles of ferric hydroxide and phosphate can be utilized by growing algae (Harvey, *J. Marine Biol. Assoc. U.K.*, 22: 205, 1937; Goldberg, *Biol. Bull.*, 102: 243, 1952).

The present method is divided into two parts: II.12.I, the determination of particulate iron, and II.12.II, the determination of soluble iron. Within each classification we have attempted to measure only the biologically reactive iron by using a preliminary treatment with hydrochloric acid. Such a treatment will liberate ferric iron from all substances likely to be available to marine phytoplankton and hence give less of an over-estimate of the immediately available biologically active iron than would a "total" iron figure obtained by some process of high-temperature wet digestion. Methods are thus simplified and shortened and have more *micronutrient* significance but the procedure is arbitrary (Strickland and Austin, *J. Conseil, Conseil Perm. Intern. Exploration Mer*, 24: 446, 1959) and must *not* be used if a true total iron figure is required. In the latter case use a method such as that given by Armstrong (*J. Marine Biol. Assoc. U.K.*, 36: 509, 1957) or the procedure of Lewis and Goldberg (*J. Marine Res.*, 13: 183, 1954), from which much of the chemistry of the present method was obtained.

SAMPLING PROCEDURE AND STORAGE

With iron analyses this subject merits special attention. The non-homogeneity of the distribution of ferric iron in ocean waters is notorious and an elaborate program of sampling and statistical analysis is necessary for really meaningful figures to be obtained in a given sea area (e.g. Cooper, *J. Marine Biol. Assoc. U.K.*, 27: 279, 1948; Schaefer and Bishop, *Limnol. Oceanog.*, 3: 137, 1958). A composite sample obtained by pumping large volumes with an all-plastic assembly may have some

value but a single 5-liter sample has very little significance, except to detect gross differences between different areas and different depths. The "soluble" iron data may be more representative.

Except near the surface in some coastal areas, where the iron content may exceed 1 $\mu\text{g-at/liter}$, one liter of sample is generally suitable. Only if precise values are necessary, in low particulate iron areas, need the sample be increased to 2 liters. The sample *must* be taken in a non-metallic sampling bottle which is best fastened to a *stainless steel* wire. Surface samples are open to suspicion and a 5-m sample is probably equally informative. Take great care that the plungers of a Van Dorn sampling bottle are not touched by dirty hands stained with rust. This is easily done if bottles are loaded onto a galvanized wire coated with rust-containing grease. Special bottles should be kept solely for iron and copper determinations and should be cleaned before use by scrubbing all parts thoroughly with strong detergent.

When seawater samples are stored in either glass or polyethylene there is a slow deposition of iron on the sides of the containers by processes of adsorption and settling. Prolonged storage of sea water in glass may lead to attack of the surface, with liberation of iron into the sample or subsequent samples. For these reasons, the samples for iron should be filtered within a few hours of removing from the sampling bottles, during which time they can be stored in clean glass or polyethylene. Before transferring iron samples from one container to another, or to a filter, the samples should be vigorously shaken. The filters containing particulate iron may be folded, clipped between paper, and stored more or less indefinitely at room temperature, if suitable precautions are taken to prevent contamination. The filtrate for "soluble" iron should be analysed without delay.

II.12.I. DETERMINATION OF PARTICULATE IRON

METHOD

A. CAPABILITIES

Range: 0.008–0.8 $\mu\text{g-at/liter}$ using a 1-liter sample

The distribution of particulate iron in sea water is so erratic that a statistical estimate of the precision of this method has little meaning. Most of the variation is introduced from the sampling technique and the *in situ* distribution of the iron. Duplicate samples taken from the same depth in different bottles may each differ by as much as 30% from the mean figure.

The precision of the *purely chemical part* of the procedure is relatively high, being better than $\pm 0.012/n^{\frac{1}{2}}$ $\mu\text{g-at/liter}$ on a 1-liter sample, where n is the number of determinations. The limit of detection of particulate iron with a single determination is about $8/V$ $\mu\text{g-at/liter}$ where V is the volume in *milliliters* of sample taken.

B. OUTLINE OF METHOD

The volume of sea water used in this method is such that the iron contained therein does not exceed 0.8 $\mu\text{g-at Fe}$ (generally 500–2000 ml). This sample is filtered through a Millipore HA filter that retains particles of diameter exceeding about 0.5 μ , and the filter is treated with hot dilute hydrochloric acid for a few minutes. The iron thus brought into solution is reacted with α, α' -dipyridyl in an acetate buffer, in the presence of hydroxylamine, to give an orange ferrous complex. The extinction of this complex is measured using 10-cm cells.

C. SPECIAL APPARATUS AND EQUIPMENT

(See Sect. F for the all-important decontamination procedure.)

Bone-tipped forceps for handling filters.

50-ml capacity stoppered graduated glass measuring cylinders, one for each determination.

D. SPECIAL REAGENTS

1. BATHOPHENANTHROLINE SOLUTION (BATHO-SOLUTION)

Dissolve 0.070 g of 4,7-diphenyl-1,10-phenanthroline (bathophenanthroline) in 100 ml of ethyl alcohol and then add 100 ml of distilled water. Keep in a well-stoppered polyethylene bottle. This solution is stable indefinitely.

2. ISO-AMYL ALCOHOL

Use the reagent grade alcohol. If this is not available it is best to distill other grades, rejecting the first 10% and the last 5% of the material during distillation.

3. HYDROXYLAMINE HYDROCHLORIDE

The reagent grade salt, $\text{NH}_2\text{OH} \cdot \text{HCl}$, should be recrystallized twice by warming a solution and chilling it in ice water, first from 0.4 times its weight of 10% v/v hydrochloric acid, then from 0.4 times its remaining weight of distilled water. Wash the final product *with a few milliliters only* of cold water and dry it by heating

in an air oven at 110 C for 1 or 2 hr. The product thus obtained *still* contains too much iron for the best work and is purified by extraction as follows:

Dissolve 10 g of the salt in 100 ml of distilled water in a clean separatory funnel. Add about 5 ml of Batho-solution and extract with about 10 ml of isoamyl alcohol. Run off the lower aqueous layer into a second separating funnel and add a further few milliliters of Batho-solution and re-extract with 10-ml portions of the alcohol until the extracts are colourless. Allow the final extract to separate for 5–10 min before running the hydroxylamine solution into a well-stoppered 130-ml polyethylene bottle.

4. SODIUM ACETATE BUFFER

Dissolve 75 g of reagent grade sodium acetate trihydrate, $\text{NaC}_2\text{H}_3\text{O}_2 \cdot 3\text{H}_2\text{O}$, in 100 ml of distilled water. Add 2 ml of hydroxylamine solution and 5 ml of Batho-solution and allow the mixture to stand for about 15 min. Extract the solution with about 10-ml portions of isoamyl alcohol until the alcohol layers are colourless. Add a further few milliliters of Batho-solution and re-extract to confirm that all iron and copper (a yellow extract) have been removed. Allow the final extract to separate for 5–10 min before separation and store the aqueous solution in a well-stoppered polyethylene bottle.

5. α, α' -DIPYRIDYL REAGENT

Dissolve 0.40 g of α, α' -dipyridyl in 2.0 ml of concentrated hydrochloric acid (sp gr 1.19) and a little water. Dilute the solution to 100 ml with distilled water.

6. IRON EXTRACTION REAGENT

Dilute 20.0 ml of concentrated hydrochloric acid (sp gr 1.19) to 500 ml with distilled water (giving a solution approximately 0.48N). Store the reagent in polyethylene.

E. EXPERIMENTAL

PROCEDURE

1. Assemble the Millipore filtration equipment and fit a filter in place using clean plastic-ended forceps and commence the filtration of a well-shaken sample (generally 1 liter) (Note *a*).

2. Having filtered a suitable volume of sample suck the filter dry (do not wash it), dismantle the filtration unit and rest the glassware on a clean paper towel until required for the next sample. Remove the filter with the forceps and place it immediately into a suitable storage container or into a 50-ml measuring cylinder, as described below.

3. Pour 10 ± 0.5 ml of iron extraction reagent into a clean well-drained 50-ml stoppered measuring cylinder. Introduce the filter into this solution by placing it centrally over the mouth of the cylinder and pushing it down into the cylinder with a blunt-ended glass rod of 3–4 mm diam. The collapsed filter should be completely submerged below the surface of the extraction reagent.

4. Place the cylinder into a pan of boiling water and allow it to stand in water near the boiling point for between 10 and 15 min (Note *b*).

5. Cool the cylinders containing the extracted iron until they are at room temperature again (Note *e*) and complete the iron determination without delay (Note *b*).

6. Add 1.0 ml of hydroxylamine solution from an automatic pipette, followed by 2.0 ml of sodium acetate buffer and mix the contents of the cylinder by shaking (Note *c*).

7. Add 1.0 ml of dipyriddy reagent from an automatic pipette and then make the volume in the cylinder to exactly 50 ml with distilled water (Note *d*). Mix thoroughly.

8. Allow the colour to develop for at least 20 min (Note *e*) and then measure the extinction of the solution in a 10-cm cell against distilled water. A wavelength of 5220 Å should be used. If a filter-type absorptiometer is used choose a filter having a maximum transmission in the region of 5000 Å.

9. Correct the measured extinction by subtracting that of a blank (Sect. F). Calculate the particulate iron content in microgram-atoms of iron per liter ($\mu\text{g-at Fe/liter}$) from the expression:

$$\mu\text{g-at Fe/liter} = \text{corrected extinction} \times F/V$$

where F is a factor obtained as described in the following Section G, and V is the number of *milliliters* of sample initially filtered in this determination. Report results to two significant figures. Should the extinction exceed about 1.5 it may be determined using a 5-cm cell and multiplying the result by 2.

NOTES

(*a*) The Millipore filter should not be touched by hand or metallic forceps. After assembly, any iron-containing dirt or dust that enters the filtration unit may be recorded as particulate reactive iron so that filtration should be started and completed without delay.

(*b*) As mentioned in the Introduction to this method this acid treatment is designed to leach out any ferric iron that can reasonably be assumed to be available for growth of marine phytoplankton. The treatment should not be prolonged beyond about 15 min as the "reactivity" of iron is purely relative and some comparatively inert forms may commence to be extracted. The heating process can be carried out batchwise and filters may remain in cold extraction reagent until a sufficient number of cylinders have accumulated. However, filters should not soak in cold acid for more than about 1–2 hr before they are heated. The very slight adsorption of dipyriddy complex seen on the filter when determining large amounts of iron results in an error of 1–2% at the most and may be neglected.

(*c*) Hydroxylamine is used to reduce ferric iron to the ferrous condition, which is the form reacting with the α, α -dipyriddy. Provided the volume of iron extraction reagent is kept in the range 9.5–10.5 ml, the *pH* of the buffered solution should fall in the range 4–4.5, which ensures the rapid reduction and complexing of any iron initially present in true solution.

(*d*) Good quality distilled water should normally be sufficiently iron-free and any iron introduced is allowed for in a blank determination (Sect. F). However certain sources (old stills, ship's condenser water, etc.) may be suspect. This possibility should always be borne in mind and the water re-distilled from a Pyrex still if necessary.

(*e*) Full colour development should occur in about 10 min, provided the temperature of the solution exceeds about 10 C, but for completeness a period of 20–30 min is allowed. The colour is completely stable thereafter for at least 24 hr. Solutions strictly obey the Beer-Lambert Law.

F. DETERMINATION OF BLANK

1. REAGENT BLANK

With good quality distilled water the blank extinction from reagents should not exceed about 0.02. The amount of iron extracted from Millipore filters by the present procedure is very small but just about significant, contributing an additional extinction of about 0.01, if the filters are handled with care. To allow for this and possible changes from batch to batch of filters, a duplicate blank determination should be carried out with each batch of samples being analysed.

Carry out the method exactly as described in Section E, paragraphs 3–9, using a fresh unwashed Millipore filter taken from the packet with forceps. Measure the extinction against water in a 10-cm cell and use the mean of duplicate values (which should not differ by more than about 0.015) to correct the sample extinction values as described in Section E, paragraph 9.

2. GENERAL PRECAUTIONS AND THE CLEANING OF POLYETHYLENE- AND GLASS-WARE

The necessity for cleanliness whilst carrying out this method cannot be overstressed, especially in a location such as the laboratory on a steel ship.

All solutions, vessels, and filtration equipment should be kept covered when temporarily not in use and the equipment must be thoroughly rinsed before using after even a short shutdown. Before each cruise the apparatus is recleaned by the following method:

All bottles used to contain reagents, the 50-ml measuring cylinders, and Millipore filtration unit and flask are freed from iron by rinsing thoroughly with hot 70% v/v hydrochloric acid, followed by liberal quantities of distilled water. When decontaminating apparatus of unknown history for the first time the cleaning solution should remain in contact with all surfaces for several minutes. When cleaning polyethylene surfaces the solution should be shaken frequently and the addition of a little acid-stable cationic wetting agent (of the aryl-trimethylammonium type) is advantageous.

G. CALIBRATION

1. STANDARD IRON SOLUTION

Dissolve 0.392 g of analytical reagent quality ferrous ammonium sulphate, $\text{FeSO}_4(\text{NH}_4)_2\text{SO}_4 \cdot 6\text{H}_2\text{O}$, in a little water. Add 2 ml of concentrated hydrochloric acid and dilute the solution to 100 ml in a volumetric flask.

$$1 \text{ ml} \equiv 10 \text{ } \mu\text{g-at Fe}$$

For use dilute 5.0 ml of the above solution to 500 ml with distilled water. Do not keep this diluted solution for longer than 1 or 2 days.

$$1 \text{ ml} \equiv 0.1 \text{ } \mu\text{g-at Fe}$$

2. PROCEDURE

Add 10 ml of iron extraction reagent (Sect. D.6) to each of six 50-ml stoppered measuring cylinders. Reserve two as blanks and to each of the remaining four

add 5.00 ml of dilute standard iron solution. Carry out the determination exactly as described in Section E, paragraphs 6–9 inclusive.

Calculate the factor F from the expression:

$$F = \frac{500}{E_s - E_b}$$

where E_s is the mean extinction of the four standards and E_b the mean extinction of the two blanks. The value for F should be near 580 and should not require re-determination, except for training purposes or when there is reason to suspect an error of technique.



II.12.II. DETERMINATION OF SOLUBLE IRON

METHOD

A. CAPABILITIES

Range: 0.04–1.5 $\mu\text{g-at/liter}$

1. PRECISION AT THE 0.75 $\mu\text{G-AT/LITER}$ LEVEL

The correct value lies in the range:

Mean of n determinations $\pm 0.03/n^{\frac{1}{2}}$ $\mu\text{g-at/liter}$.

2. PRECISION AT THE 0.1 $\mu\text{G-AT/LITER}$ LEVEL

The correct value lies in the range:

Mean of n determinations $\pm 0.025/n^{\frac{1}{2}}$ $\mu\text{g-at/liter}$.

3. LIMIT OF DETECTION

The smallest quantity of soluble reactive iron that can be detected with certainty by a single determination is about 0.025 $\mu\text{g-at/liter}$.

B. OUTLINE OF METHOD

100 ml of filtered sea water is treated with hydrochloric acid and then reacted with bathophenanthroline in an acetate buffer in the presence of hydroxylamine. The coloured ferrous complex thus formed is extracted into isoamyl alcohol and the extinction of the coloured extract is measured using a 10-cm cell.

C. SPECIAL APPARATUS AND EQUIPMENT

(See Part II.12.I, Sect. F, for the all-important decontamination procedure.)

The present determination is carried out on the filtrate from the particulate iron determination and thus the equipment needed for that method is required for the present procedure.

In addition there is required, for each determination, a pear-shaped separatory funnel of at least 200-ml capacity, with the stem shortened to a few centimeters length and the end tapered somewhat.

50-ml stoppered measuring cylinders are also required for this method and may constitute an additional requirement if the soluble iron determination is carried out before the particulate determination is concluded.

D. SPECIAL REAGENTS

The same reagents are required as for the particulate iron method, Part II.12.I, Sect. D, except for the α,α' -dipyridyl solution, which is not used.

E. EXPERIMENTAL

PROCEDURE

1. Transfer 100 ml of filtrate from the particulate iron determination (Note *a*) into a clean separatory funnel.

2. Add 10 ml of iron extraction reagent followed by 2 ml of hydroxylamine hydrochloride solution from an automatic pipette. Mix the solutions in the separatory funnel and allow the mixture to stand for 5 min (Note *b*).

3. Add 2.0 ml of acetate buffer from an automatic pipette followed by 5 ml of Batho-solution. Mix and allow the solution to stand for 10 min (Note *c*).

4. Measure from a dry 50-ml stoppered cylinder 30 ± 1 ml of isoamyl alcohol and drain the alcohol into the separating funnel. Do not wash the cylinder but re-stopper it. Extract the contents of the separatory funnel vigorously for 1 min and then allow the layers to separate for at least 5 min. Discard the lower aqueous layer. Swirl the funnel to dislodge any water droplets, allow the water to collect and again separate the aqueous layer.

5. Run the alcohol layer, without contamination from more than a drop or two of aqueous solution, back into the 50-ml measuring cylinder. Make the volume to exactly 35 ml with acetone and mix (Note *d*).

6. Measure the extinction of the solution in a 10-cm cell against distilled water using a wavelength of 5330 Å with a spectrophotometer. If a filter-type absorptiometer is used, choose a filter having a maximum transmission in the region of 5500 Å (Note *d*). Rinse the sample cell with acetone after taking each reading.

7. Correct the measured extinction by subtracting that of a blank (*see* Sect. F). Calculate the soluble iron content in microgram-atoms of iron per liter ($\mu\text{g-at Fe/liter}$) from the expression:

$$\mu\text{g-at Fe/liter} = \text{corrected extinction} \times F$$

where *F* is a factor described as in Section G below.

NOTES

(*a*) Careful use of a clean 100-ml measuring cylinder for this measurement is adequate.

(*b*) All colloidal forms of ferric hydroxide, etc., are brought into solution. The more stable organic complexes may not be attacked although it is impossible to generalize on this point and the method may well *overestimate* the soluble iron capable of being utilized by phytoplankton.

(*c*) At room temperature, all dissolved ferric iron that is not already strongly complexed will form the ferrous-bathophenanthroline complex which can be extracted into amyl alcohol. Much of the increased sensitivity that results from the use of bathophenanthroline (rather than 1,10-phenanthroline or *o,o*-dipyridyl) is brought about by the fact that the coloured complex can be concentrated by extraction.

(*d*) Very slight losses of iron that occur because of incomplete return of alcohol from the separating funnel into the cylinder and incomplete extraction of the ferrous-bathophenanthroline complex are allowed for in the calibration procedure. The use of acetone ensures that a constant volume of extract is used (35 ml) and lessens any clouding from droplets of occluded sea water. Extinction values are not affected by the presence of sea water and a calibration may be carried out using distilled water. The slight clouding from entrained water is largely allowed for in the blank determination (Sect. G), but for the best work, with very small amounts of iron, an extinction determined at 6500 Å should be subtracted from the extinction measured at 5330 Å to allow for turbidity.

F. DETERMINATION OF BLANK

The sensitivity of this method is so great that it is best to use doubly distilled water. Add 100 ml of such water to a separatory funnel and continue as described in Section E, paragraphs 2–6 inclusive. The extinction value should not exceed about 0.1–0.15. For surety at least one blank determination should be carried out with each batch of samples.

G. CALIBRATION

The same dilute iron solution is used as is employed in Part II.12.I:

1 ml \equiv $\mu\text{g-at Fe/liter}$ on 100 ml of sample

Add 100 ml of doubly distilled water and 10 ml of iron extraction reagent to a series of six separatory funnels. Treat two as blanks and to each of the remaining four add 1.00 ml of dilute standard iron solution.

Carry out the determination exactly as described in Section E, paragraphs 3-6 inclusive, after adding 2 ml of hydroxylamine hydrochloride solution.

Calculate the factor F from the expression:

$$F = \frac{1.00}{E_s - E_b}$$

where E_s is the mean extinction of the four standards and E_b the mean extinction of the two blanks. The value for F should be near 1.5 and should not require re-determination, except for training purposes or if there is reason to suspect the technique.



II.13. DETERMINATION OF MANGANESE

INTRODUCTION

The quantities of manganese in sea waters are so low that any method which oxidizes this element to permanganate cannot achieve an adequate sensitivity without a lengthy pre-concentration technique (e.g., Thompson and Wilson, *J. Am. Chem. Soc.*, 57: 233, 1935). The catalytic oxidation of the leuco-base of triphenyl-methane dyes by manganous ions gives rise to a very sensitive method, as several hundred dye molecules can be produced from each manganous ion initially present. The use of periodate with "tetra-base" was suggested by Harvey (*J. Marine Biol. Assoc. U.K.*, 28: 155, 1949) but is not very suitable for routine work.

The following method is based on unpublished work by one of us (Strickland) on the mechanism of the manganese-catalysed oxidation of the leuco-base of malachite green. This compound is to be preferred to tetra-base and has recently been used by several workers (e.g. Yuen, *Analyst*, 83: 350, 1958). An excellent account of the kinetics of this reaction is given by Fernandez, Sobel, and Jacobs (*Anal. Chem.*, 35: 1721, 1963). The application of the method to sea water presents a few difficulties as even this extraordinarily sensitive method (probably the most sensitive colorimetric method known) has to be used close to its limit of detection.

Manganese is generally considered to be present in sea water in the divalent state and is mostly "soluble," although in surface waters the fraction retained by a HA filter may reach 25% of the total. The following method measures those forms of the element brought into solution at pH 4 and probably gives a fair measure of the biologically active manganese.

METHOD

A. CAPABILITIES

Range: 0.0025–0.25 $\mu\text{g-at/liter}$

The distribution of manganese in sea water tends to be erratic (*refer to* remarks in Method II.11) but not so markedly as with iron.

1. PRECISION AT THE 0.04 $\mu\text{G-AT/LITER}$ LEVEL (Well-shaken sample of inshore surface water)

The correct value lies in the range:

Mean of n determinations $\pm 0.0025/n^{\frac{1}{2}}$ $\mu\text{g-at/liter}$.

2. PRECISION AT THE 0.004 $\mu\text{G-AT/LITER}$ LEVEL (Deep ocean water)

The correct value lies in the range:

Mean of n determinations $\pm 0.0015/n^{\frac{1}{2}}$ $\mu\text{g-at/liter}$.

3. LIMIT OF DETECTION

The smallest amount of manganese that can be detected with certainty is about 0.0025 $\mu\text{g-at/liter}$.

Reject duplicate determinations if the extinction values differ by more than about 0.015. If duplicate extinction values differ by less than this take a mean value.

B. OUTLINE OF METHOD

The leuco-base of the triphenylmethane dye malachite green is oxidized by periodate to the dye-stuff very slowly at pH 4 in an acetate buffer. In the presence of manganese the oxidation proceeds rapidly, the manganese acting as a catalyst. The dye is slowly destroyed by a second reaction but after a suitable time interval extinctions at 6150 \AA are nearly proportional to the initial amount of manganese present in the sample.

C. SPECIAL APPARATUS AND EQUIPMENT

50-ml capacity stoppered graduated measuring cylinders, *two* for each determination. These cylinders are cleaned *after each use* by rinsing with a few milliliters of concentrated hydrochloric acid and then with copious quantities of distilled water.

One polyethylene wash bottle of at least 300-ml capacity.

D. SAMPLING PROCEDURE AND SAMPLE STORAGE

There are no particular precautions indicated for seawater sampling except that a non-metallic sampling bottle *must* be used. Most of the manganese in sea water is in a "soluble" form and the amount should not change greatly during a few days storage except in samples taken near the surface at inshore locations. As a precaution, samples should be frozen if the delay between sampling and analysis is to exceed 1 day. There may well be a slow deposition of manganese onto the walls of glass or plastic containers over prolonged storage.

E. SPECIAL REAGENTS

1. ACETATE BUFFER

Dilute 30 ml of analytical reagent quality glacial acetic acid to 1000 ml with distilled water. Add carefully to this a solution of 3–4 g of analytical reagent quality sodium hydroxide in about 20 ml of water until the pH of the buffer lies in the range of 4.1–4.2 as measured by a glass-electrode pH meter. Store the solution in a polyethylene bottle. The solution is stable for many months in the absence of evaporation.

2. POTASSIUM PERIODATE SOLUTION

Dissolve 1.0 g of analytical reagent quality potassium periodate, KIO_4 , in 500 ml of distilled water and add one small pellet (about 0.2 g) of sodium hydroxide. Store the solution in an amber glass bottle out of direct sunlight. The solution is stable for several weeks if stored in the dark, but slowly decomposes when exposed to strong light, forming undesirable oxidants. For the best results the solution should be made up fresh every few days.

3. 4,4'-BISDIMETHYLAMINOTRIPHENYLMETHANE SOLUTION

Dissolve 0.20 g of alcohol recrystallized leuco-malachite green in 250 ml of pure acetone. This solution is stable but should not be allowed to evaporate. The development of a slight green colouration does no harm.

F. EXPERIMENTAL

PROCEDURE

1. Add 30 ml of sample to a 50-ml stoppered graduated measuring cylinder. For precise work (*see* Sect. H) fill another cylinder with 30 ml of the same sample and add 1.0 ml of manganese standard.

2. Measure in 15 ml of acetate buffer from a polyethylene wash bottle, making the total volume (as measured in the cylinder) to 45 ml (Note *a*). Place the cylinders in a thermostatically controlled water bath at a temperature between 23 and 26 C, held constant to ± 1 C or better (Note *b*).

3. After the solutions have come to temperature (allow 15–30 min) add 5.0 ml of periodate solution from an automatic pipette. Mix the solutions thoroughly and allow them to stand for a further 10–15 min (Note *c*).

4. Add, with rapid mixing, 1.0 ml of leuco-base solution from an automatic pipette and return solutions to the thermostatically controlled bath.

5. Between 4 and 5 hr after adding the leuco-base measure the extinction of a sample solution in a 2-cm cell (rarely a 1-cm cell may be required) against a “blank” determination (*see* Sect. G), using light of wavelength 6150 Å (Note *d*). If a filter-type absorptiometer is used choose a filter having a peak transmission including a wavelength of 6200 Å. Correct for any cell-to-cell blank (Sect. G) and record extinction values (*E*) to the nearest 0.001. Unless adjacent samples are known to have extinction values within about 25% of each other the absorptiometer cell should be rinsed with each new solution before filling.

6. Calculate the manganese concentration in microgram-atoms of manganese per liter ($\mu\text{g-at Mn/liter}$) from the expression:

$$\mu\text{g-at Mn/liter} = \frac{E}{E_s - E} \times 0.05$$

where *E* is the extinction measured against a “blank” solution but corrected for any cell-to-cell blank (Sect. G) and *E_s* the extinction of the sample to which 1.0 ml of manganese standard has been added. Of the numerous compounds which can interfere only iron is likely to have any significant effect in sea water. The extinction resulting from the presence of iron is about 1% of that obtained from the same molecular concentration of manganese. The greatest interference to be expected in most sea areas will therefore not exceed about the equivalent of 0.005 $\mu\text{g-at Mn/liter}$ and can generally be neglected. A small correction can be made if the particulate reactive iron value is known (*see* Part II.12.I) by assuming that

$$1 \mu\text{g-at Fe/liter} \equiv 0.01 \mu\text{g-at Mn/liter}$$

NOTES

(*a*) Acetate is essential for the reaction, as well as providing a buffer. The amount of dye formed per unit of manganese is a sensitive function of *pH*, decreasing rapidly as the *pH* decreases below about 4. At a *pH* greater than about 4.2 the amount of dye produced by a manganese-independent reaction (Sect. G) becomes undesirably high.

(*b*) The amount of dye produced per unit of manganese, also the rate of formation of the dye, depends upon temperature. A decrease in sensitivity of about 4% per 1 C decrease in

temperature is to be expected. 25 C is a suitable temperature and fluctuations of less than ± 1 C during colour development may be neglected as they are largely allowed for by the procedure of internal standardization.

(c) The exact concentration of periodate is not critical but should be maintained to 5% or better. The reproducibility and sensitivity of colour development appears to improve somewhat if the periodate reacts for a few minutes with the manganese before the dye-base is added. Ten minutes is a generous excess time and is not critical.

(d) The time for full colour development increases with the salinity of a sample. For salinities of 25‰ or less, 2 hr is sufficient but a period of at least 4 hr should be allowed to ensure completion with samples of salinity exceeding 33‰. The manganese-independent reaction affecting the blank (Sect. G) increases with time rather rapidly for the first 1 or 2 hr, but the rate of change is less marked at 4–5 hr and the blank is then less erratic and less dependent on salinity.

G. DETERMINATION OF BLANK

1. REAGENT BLANKS

a. *Manganese-free Sea Water*

To about 1000 ml of HA Millipore-filtered sea water of approximately known salinity (an open ocean source of high salinity is preferable) add about 5% w/v sodium hydroxide solution *dropwise* with vigorous stirring until a slight permanent precipitate is formed. Bring the solution to the boil and boil for about 5 min. Allow the precipitate to stand, with occasional stirring, as it cools to room temperature (2–3 hr) in a well-covered beaker. When the precipitate has settled decant the bulk of the liquid through a 12.5-cm No. 42 Whatman or similar fine-grain filter paper but do not wash. Add approximately 2% v/v hydrochloric acid to the filtrate *dropwise* until the pH of the filtered sea water is anywhere between 7.8 and 8.2. For general use (*see below*) dilute the solution until the salinity is judged to be about 29‰ and store it in a well-stoppered polyethylene bottle. The resulting sample of sea water should be completely free from manganese and iron impurities with the loss of only a small fraction of its magnesium and calcium content.

b. *Procedure*

If good quality distilled water is used, and the acetate buffer is made from acetic acid and sodium hydroxide, rather than sodium acetate, the amount of manganese introduced by reagents should be very small and is unlikely to exceed the equivalent of about 0.005 $\mu\text{g-at/liter}$ on a 30-ml sample. There is, however, a slow formation of dye-stuff by an oxidation reaction not resulting from the presence of manganese. The rate of this reaction depends upon variables such as pH and temperature but is relatively independent of salinity. For any given batch of samples the manganese-independent reaction is reproducible and a "blank" determination with "manganese-free" sea water of a salinity of about 29‰ can be used to control a batch of samples having salinities in the range of 25–35‰. For the most precise work with samples of salinity below about 25‰ or with a very low manganese content, the manganese-free water should be prepared having a salinity within 2–3‰ of the sample being analysed. The manganese-independent blank extinction *increases* appreciably as salinity decreases, being about 1.5 times as great in pure water as it is in sea water of salinity 35‰.

For each batch of samples prepare one or more blank solutions (as necessary)

by taking 30 ml of manganese-free sea water of suitable salinity through the method exactly as described in Section F, paragraphs 1–4. To prevent complications due to slight colour increases whilst measuring a large batch of samples, all samples should be measured against the blank solution rather than against distilled water. (The extinction of a blank against water in a 2-cm cell should not exceed about 0.25.) The reaction giving the manganese-independent blank may arise from periodate directly or from impurities in the periodate. Exposure of neutral periodate solutions to strong light greatly increases the amount of dye-stuff formed by this reaction.

2. CELL-TO-CELL BLANKS

Refer, for example, to Part II.2.I, Section G.1.

3. GENERAL PRECAUTIONS AND THE CLEANING OF POLYETHYLENE- AND GLASS-WARE

The precautions outlined in Part II.11.I, Section F.2, apply to the present method, if perhaps slightly less critically, for any iron contamination will appear as manganese if sufficiently large. All glassware, etc. should be cleaned in 70% v/v hydrochloric acid. Be *very careful* that there is no cross-contamination from the manganous sulphate in Part I.3. This can occur, for example, if BOD bottles, containing traces of oxygen reagents, are used first in a surface sample bucket before samples are drawn for manganese analysis.

H. CALIBRATION

1. STANDARD MANGANESE SOLUTION

Dissolve 0.255 g of manganese sulphate monohydrate, $\text{MnSO}_4 \cdot \text{H}_2\text{O}$, in 1000 ml of distilled water containing one or two drops of concentrated hydrochloric acid. This solution is stable indefinitely in the absence of evaporation.

$$1 \text{ ml} \equiv 1.50 \text{ } \mu\text{g-at Mn}$$

Dilute for immediate use 1.0 ml of the above solution to 1000 ml with distilled water. This solution should not be kept for more than about 2 days.

$$1 \text{ ml} \equiv 0.00150 \text{ } \mu\text{g-at Mn} \equiv 0.05 \text{ } \mu\text{g-at Mn/liter on a 30-ml sample}$$

2. PROCEDURE

The amount of malachite green formed from a given manganese content is a function of salinity (increasing about 40% as the salinity decreases from 35‰ to 20‰ and being 60% higher in distilled water). There are also slight variations in sensitivity from batch to batch of samples for reasons not fully understood. For the most precise work, therefore, each sample should be analysed in duplicate, adding 1.0 ml of dilute manganese standard to one aliquot and calculating the final manganese concentration as described in Section F, paragraph 6. With a large batch of samples of water having practically the same salinity and from the same location, e.g. the deep samples from a single hydrographic station, only one sample need be chosen for this standardization procedure. The increase in extinction to be expected from the 0.05 $\mu\text{g-at Mn/liter}$ added for standardization purposes varies between about 0.3 and 0.6 with a 2-cm cell.

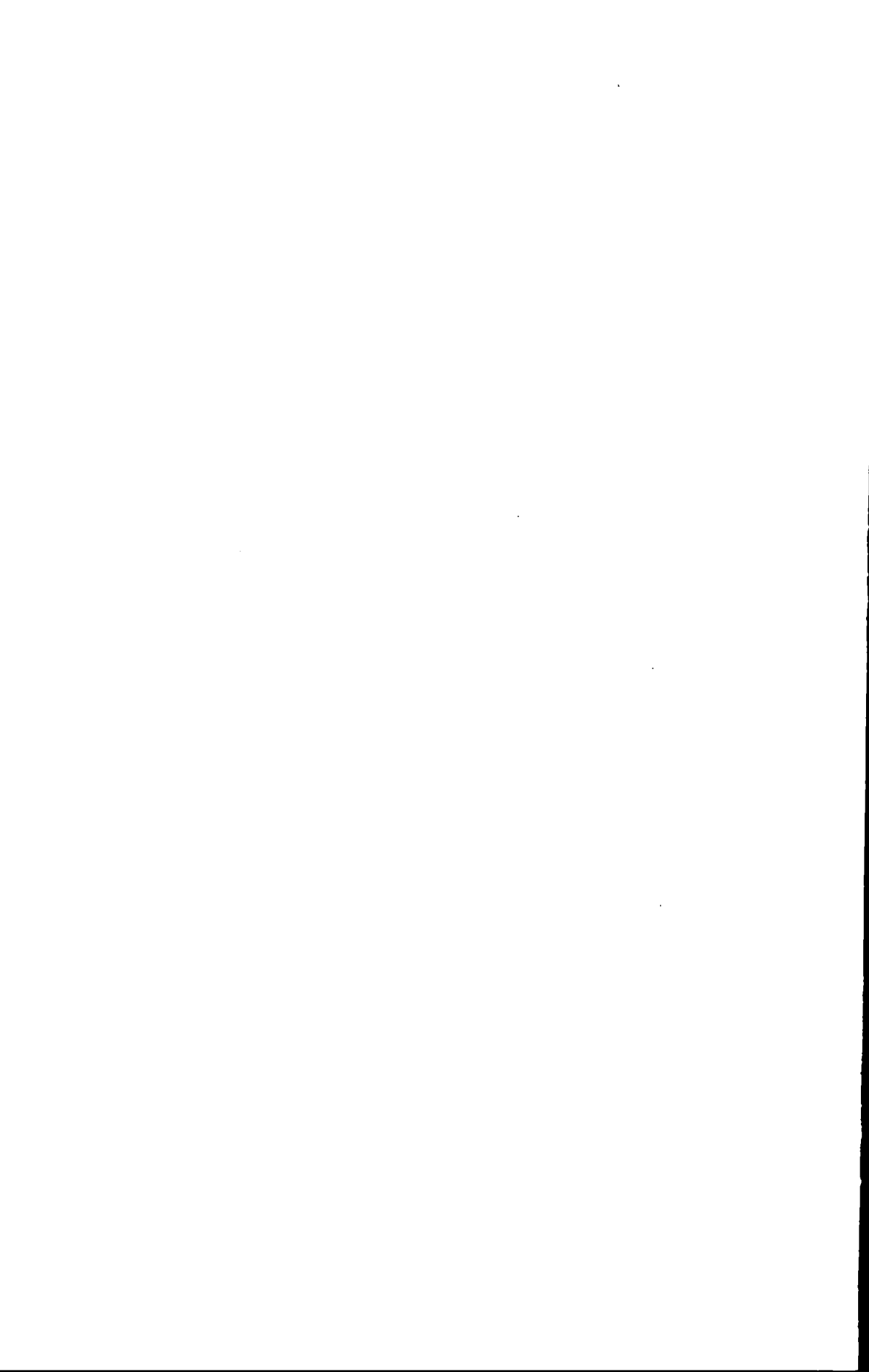

II.14. DETERMINATION OF COPPER

INTRODUCTION

The diethyldithiocarbamate reagent for copper is practically specific for this metal in sea water and a simple extraction procedure, using small volumes of carbon tetrachloride and long-path-length absorptiometer cells, gives an adequate sensitivity. Chow and Thompson (*J. Marine Res.*, 11: 124 1952) have suggested a similar direct approach, but, mainly because of optical considerations, their method is considerably less sensitive than the one which follows. Both this method and the methods for manganese and soluble iron described previously determine only the non-complexed or weakly-complexed forms of the metal ions. A significant fraction of the "soluble" copper in the sea may be strongly bound to organic matter and not react with diethyldithiocarbamate (*below*).

The present method concludes this section on micronutrients without mention of several metals of significance to plant physiology, in particular molybdenum and zinc. However, there is as yet little requirement for an analysis of sea water for such elements on a routine basis. Any such work would probably form part of detailed research on specific aspects of nutrition and is out of place in the present compilation.

METHOD

A. CAPABILITIES

Range: 0.006–0.2 $\mu\text{g-at/liter}$

1. PRECISION AT THE 0.05 $\mu\text{g-AT/LITER}$ LEVEL

The correct value lies in the range:

Mean of n determinations $\pm 0.007/n^{\frac{1}{2}}$ $\mu\text{g-at/liter}$.

2. LIMIT OF DETECTION

The smallest quantity of copper that can be detected with certainty by a single determination is about 0.006 $\mu\text{g-at/liter}$.

B. OUTLINE OF METHOD

The sea water is treated with sodium diethyldithiocarbamate and the yellow copper complex extracted by a small volume of carbon tetrachloride. The extinction of a 15-ml extract is measured in a 10-cm cell.

C. SPECIAL APPARATUS AND EQUIPMENT

A pear-shaped separatory funnel of 1-liter capacity with the stem cut to about 1-inch length and the end tapered somewhat. Only one funnel is required per analyst as it is inconvenient to undertake more than one analysis at a time. Before use this funnel and all other glass apparatus should be given a rinse with 50% v/v hydrochloric acid, followed by copious quantities of distilled water, to remove any copper, iron or other metal impurities on the glass surfaces.

"Small volume" spectrophotometer cells having a path length of 10 cm but holding 10 ml or less of solution.

D. SAMPLING PROCEDURE AND SAMPLE STORAGE

It is mandatory that samples for copper analysis be taken with all-plastic equipment. The use of a sampling bottle with bare brass, monel metal, or other copper alloys appearing anywhere at internal or *external* surfaces, will invalidate results. Stainless-steel straps and clips probably give no trouble. Samples should be transferred to polyethylene bottles for storage. We have no experience concerning the stability of samples in storage but, presumably, if they are frozen to -20°C and stored in the dark there will be no deterioration. Samples should not be filtered before analysis unless a "soluble" copper result is specifically required.

E. SPECIAL REAGENTS

Note: The water used in this method is best "de-ionized" by passing ordinary distilled water through a small column of cation exchange resin (in the hydrogen form) before use.

1. CARBON TETRACHLORIDE

The analytical reagent grade chemical may contain a trace of copper and should be redistilled from all-glass equipment before use. Store the purified solvent in a dark glass bottle.

2. SODIUM DIETHYLDITHIOCARBAMATE SOLUTION (DEDTC REAGENT)

Dissolve 2 g of good quality sodium diethyldithiocarbamate in 200 ml of de-ionized water and add about 0.1 g of anhydrous sodium carbonate. Store in a well-stoppered glass or polyethylene bottle. The solution is stable only for about 1 week and should be discarded as soon as a strong unpleasant smell develops.

F. EXPERIMENTAL

Section G.3 should be consulted before commencing this determination.

PROCEDURE

1. Adjust the temperature of the sea water to be between 18°C and 23°C and measure 750 ± 20 ml of sample into the separatory funnel from a liter measuring cylinder. Add 2 ml of DEDTC reagent from a 2-ml automatic pipette (Note *a*).

2. Place about 16 ml of carbon tetrachloride in a clean 25-ml measuring cylinder. Pour approximately 5 ml of this solvent into the separatory funnel and extract the sea water by vigorous shaking for 1 min. Allow the carbon tetrachloride to separate for a few minutes, swirling the funnel gently to loosen droplets from the surface, and then run off the organic layer into another clean 25-ml measuring cylinder (Note *b*).

3. Repeat this operation twice more, collecting the resulting 13–14 ml of extract in the one cylinder. Make the volume to exactly 15 ml by adding a few drops of pure solvent (Note *c*). Ignore a little separated water which should, however, not exceed about 1 ml (Note *b*).

4. Mix the extracts by shaking or stirring the contents of the cylinder with a glass rod and then filter the solution through a *dry* 9-cm No. 41 H Whatman filter paper into a spectrophotometer cell having a volume less than 15 ml and a path length of 10 cm. Measure the extinction against carbon tetrachloride (Note *d*).

A wavelength of 4340 Å should be used. With this method it is sufficiently precise simply to drain cells before refilling them.

5. Correct the measured extinction by subtracting a reagent blank obtained as described in Section G. Calculate the copper concentration in microgram-atoms of copper per liter ($\mu\text{g-at Cu/liter}$) from the expression:

$$\mu\text{g-at Cu/liter} = \text{corrected extinction} \times F$$

where F is a factor obtained as described in Section H below. Report results to two significant figures. Many ions interfere with this method but at the $p\text{H}$ of sea water none will react with the DEDTC reagent to give significant interference in normal samples.

NOTES

(a) The effect of temperature on this method is negligible but if samples are at room temperature there will be less tendency for emulsification to take place during extraction. The concentration of DEDTC is not critical and $p\text{H}$ is without effect on the method provided it is within the normal range found in the sea (7.3–8.5).

(b) The separation of carbon tetrachloride at the bottom of the funnel should be fairly clean but if much particulate matter is present in samples some emulsification may persist and the extraction procedure used in blank determinations (Sect. G, *below*) should be followed.

(c) It is necessary to extract vigorously for a full minute. Under these conditions about 60% of the copper in the aqueous phase is removed for each 5-ml addition of carbon tetrachloride. The third addition of carbon tetrachloride has a "scavenging" action and raises the percentage of the copper extracted to about 95%. There is no point in continuing with further additions of solvent to remove the last few per cent. The fraction extracted is reproducible and the slight error is allowed for by the calibration procedure.

(d) Filtration clears the solution of any fine droplets of occluded sea water. The extract should be crystal-clear to the eye (re-filter if necessary) and the filter paper must be renewed for each filtration. With 10-cm cells of small cross-section, such as used here, it may be best to compare samples against carbon tetrachloride rather than water, as in the latter case cell-to-cell blanks (*see* Sect. G) may become undesirably high because of optical effects.

G. DETERMINATION OF BLANK

1. CELL-TO-CELL BLANKS

Refer, for example, to Part II.2.I, Section G.1.

This blank determination is not required, as such, but it is useful to know the value because it will indicate whether or not the reagent blank, *per se*, is undesirably high.

2. PROCEDURE

Add 250 ml of de-ionized distilled water to the separatory funnel, add 1 ml of DEDTC reagent and extract vigorously with two 10-ml portions of carbon tetrachloride, discarding the extracts. This procedure removes any copper from the water. Add 2 ml of DEDTC reagent and carry out the determinations as described in Section F. In pure water there is a tendency to form stable emulsions with some of the carbon tetrachloride added. To avoid excessive waiting for this emulsion to break, the clear solvent *and emulsion* should be run off into the 25-ml cylinder after about 5 min. In the cylinder the emulsion will generally break quite readily if agitated and after the third extraction the combined extracts should be returned to

the funnel, *without* any shaking, and again separated into the measuring cylinder. This time there should be very little water occluded. Measure the extinction of the blank and use it to correct the sample extinction. The value of the reagent blank, corrected for cell-to-cell blank, should not exceed about 0.04–0.05 and probably arises mainly from traces of metallic impurities in the carbon tetrachloride and glassware.

3. PRECAUTIONS TO REDUCE CONTAMINATION

Some care is required to see that traces of metallic impurities are not introduced into solutions from the surface of glass- or polyethylene-ware. *All* bottles, cylinders, etc. should be given a preliminary rinse with 50% v/v hydrochloric acid, washed well with distilled water, and stored with interior surfaces protected from atmospheric contamination.

H. CALIBRATION

1. STANDARD COPPER SOLUTION

Dissolve 0.375 g of analytical reagent quality cupric sulphate pentahydrate, $\text{CuSO}_4 \cdot 5\text{H}_2\text{O}$, in 1000 ml of distilled water. The solution is stable indefinitely.

$$1 \text{ ml} \equiv 1.5 \text{ } \mu\text{g-at Cu}$$

Dilute 5.0 ml of this solution to 100 ml with distilled water for use. Do not keep this solution for more than about 1 day.

$$1 \text{ ml} \equiv 0.075 \text{ } \mu\text{g-at Cu} \equiv 0.1 \text{ } \mu\text{g-at Cu/liter on a 750-ml sample}$$

2. SEA WATER

The presence of salts has practically no effect on this method but a calibration using sea water is to be preferred to one using fresh water as the presence of electrolyte greatly reduces the tendency for emulsions to form with carbon tetrachloride. Synthetic sea water is useless because even the purest laboratory chemicals introduce prohibitively large amounts of copper. A filtered sample of surface sea water with a salinity in the range 25–38‰ is quite satisfactory. About 5 liters of well-mixed sample is required.

3. PROCEDURE

Follow the method described above, using the seawater sample in duplicate. Carry out three more analyses on 750-ml samples to each of which 1.00 ml of dilute copper standard has been added.

Evaluate the factor F from the expression:

$$F = \frac{0.10}{E_s - E_b}$$

where E_s is the mean extinction of the three standards and E_b is the mean extinction of the two blanks (uncorrected for cell-to-cell or reagent blanks). F should be near 0.2 and should not require redetermination except for training purposes.

II.15. AUTOMATED NUTRIENT ANALYSIS

II.15.I. DESCRIPTION OF APPARATUS

A. GENERAL

At the time of writing, techniques for the automatic analysis of micronutrients in sea water are being developed by many workers and several have been published, e.g. P. G. Brewer and J. P. Riley, *Deep-Sea Res.*, 12: 765, 1965; A. Henriksen, *Analyst*, 90: 29, 1965. The following is a brief account of the principles involved in one of the possible approaches, (*cf.* Armstrong *et al.* *Deep-Sea Res.*, 14: 381, 1967) in which components made by the Technicon Instruments Corporation of Ardsley, New York, USA are used. The layout of the equipment shown here is taken from the apparatus used in our laboratories but is shown only as an illustration, as no standardized form of the apparatus can yet be specified. For a similar reason we have not given working instructions in the great detail found elsewhere in this book but only describe briefly the basic chemistry and methodology.

The nutrients are determined by modifications of the sensitive spectrophotometric methods used in the more conventional methods of seawater analysis, except that both sample and reagents flow continuously through the system. Reagents are added to the sample in the correct order and relative amounts. The times necessary for the chemical reactions to be completed are obtained by passing solutions through coils of glass tubing of various lengths. As the total length of small-bore glass tubing is very long (many meters), small air bubbles are injected into the system to prevent a bad "tailing" of the record. This can occur when a concentration gradient (e.g. a change from standard to blank solution) travels through such a length of tubing. (The trouble arises from the viscous slowing of a solution near the tube wall compared with the liquid in the centre of the tube.) This injection of air and the excellent peristaltic pump, both introduced into automatic analysis by the Technicon Instruments Corporation, are responsible for the success of this approach, which is particularly suited to the analysis of a continuous stream of sample, such as can be obtained from a ship at sea.

When coloured solutions have been obtained by suitable chemistry, these are pumped through colorimeters similar in principle to those used in spectrophotometric analysis. Light of the most suitable wavelength is obtained from incandescent lamps and interference filters, and the transmission of a solution (100% for a blank down to about 10% for samples) is measured by a pen recorder from which the concentration of a nutrient can be evaluated after suitable standardization.

B. LAYOUT OF APPARATUS

A suggested layout of a bench unit is shown in Fig. 1. Recorders may be housed elsewhere and, in our equipment, the flow of certain solutions is controlled by a bank of solenoids, but this can be done by taps. Similarly we have elected to select for certain methods and flow rates by rearranging tube connections on a central panel ("Tubing Exchange Panel") but such an approach is a matter of choice and will not be referred to again. An idealized version of the pumping system used is given in Fig. 2. The bench unit also houses a fluorometer (*see* IV.3.1V) and a filter for incoming sea water.

All this equipment is conveniently mounted on the upper surface of a large box in which can be housed much of the wiring and tubing. Reagent bottles and bottles for standards and blanks, etc., can be sunk in circular wells shown as circles in Fig. 1. The reagents are mixed in coils and tubing fastened to the "platforms."

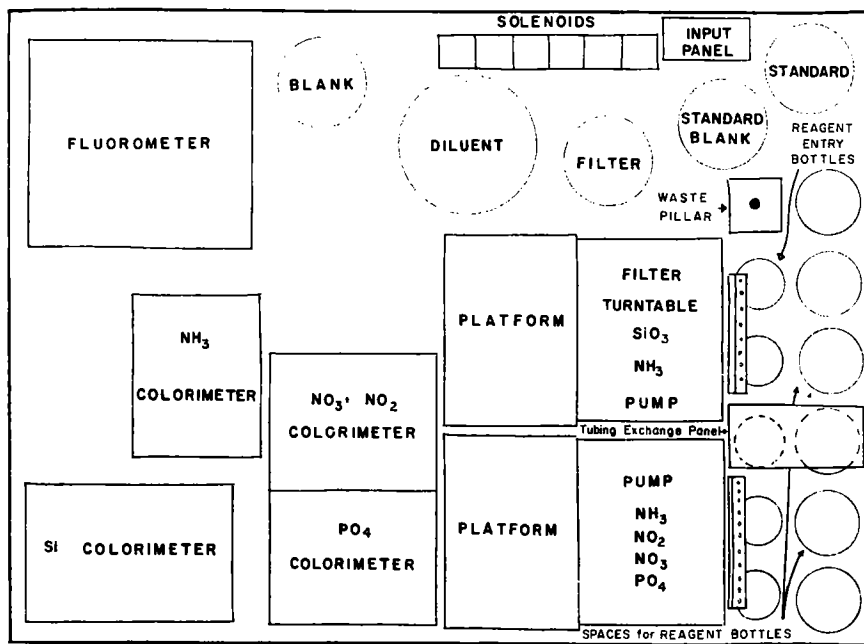

FIG. 1. Layout of a bench unit for automated nutrient analysis.

C. DESCRIPTION OF PROCEDURES A, B, AND C

Nutrient analysis has been designed around three main approaches, Procedures A, B, and C, which represent compromises in sensitivity according to the concentrations of nutrients to be expected in various circumstances.

Procedure A utilizes the full sensitivity of all methods and is generally used when measuring the concentration of nutrients in surface waters, whilst the ship is underway. Occasionally in areas of high coastal upwelling, where surface nitrate concentrations exceed $7 \mu\text{g-at N/liter}$, the sensitivity may be too great, necessitating the use of Procedure B.

Procedure B is designed for work with a profiling hose to obtain nutrient profiles to 100–200 m. A modified Procedure B may be used where the maximum concentration of nitrate does not exceed about $15 \mu\text{g-at N/liter}$.

Finally, *Procedure C* is used when water samples are to be analyzed from hydro-casts and employs a special "turntable" of sample tubes which can be obtained from the Technicon Instruments Corporation. The potential range of concentrations is then greatest ($0\text{--}40 \mu\text{g-at N/liter}$ of nitrate in the Pacific Ocean) and some compromise must be made. Procedure C is rather too insensitive for near-surface samples, but in hydrography an exact value of such samples is rarely needed. The

Procedure is too sensitive for the deeper samples but they may be diluted by a known amount before placing them on the turntable.

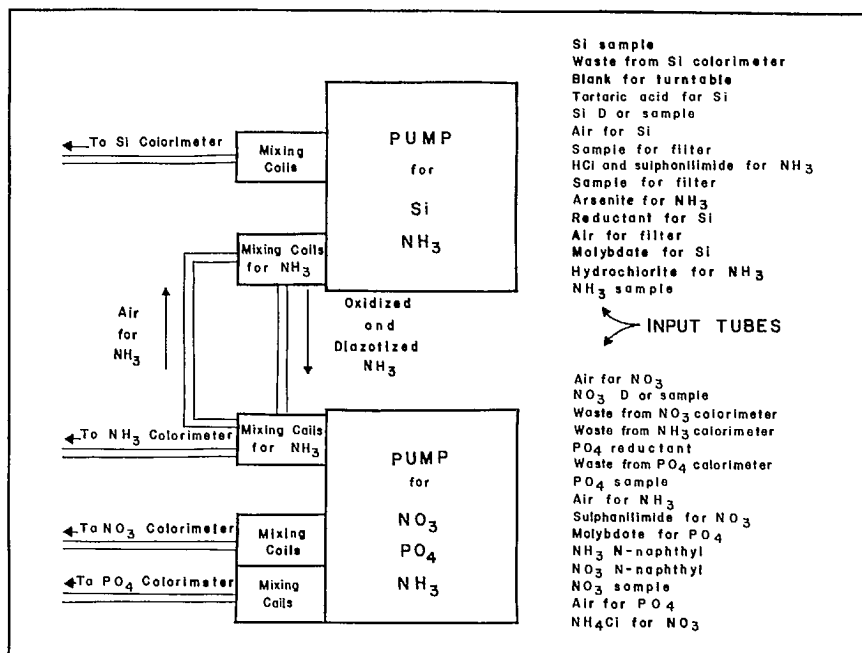

FIG. 2. Platforms for the pumping system.

D. THE FILTER

This ingenious device is used with Procedures A and B to remove suspended matter (plankton, silt, etc.) which can give a variable turbidity. Its use is essential with Procedure A in coastal waters. The filter is a dialysis unit made by the Technicon Instruments Corporation fitted with a circle of 3- μ pore-size Millipore filter with a centre hole made to enable it to fit the container. The sample plus air is pumped through the spiral groove beneath the filter membrane and the clear water sucked, on demand, from the corresponding groove on top of the membrane. The air bubbles have a brushing action preventing the clogging of the filter, which can generally be used for many weeks, even in water with high plankton blooms. Failure of the system is generally detected by the presence of bubbles in the water leaving it for analysis.

E. COLORIMETERS AND CALCULATIONS

1. GENERAL

A coloured solution, obtained as a result of the chemistry of a given method, is pumped, together with segments of air, into the colorimeter and sucked from it by another tube in the pump which sucks about 1.5 ml/min less rapidly than the

incoming stream. The balance of liquid (about 1.5 ml/min) carries off the air through the "debubbling" device seen outside each colorimeter.

The recording equipment is readied as follows: With both photocells illuminated and a blank solution pumping through the cell, adjust the 100% dial until the pen is at the extreme right of the chart paper. If it is impossible to get to this position, the position of the lamp in the colorimeter may require altering.

Block all light from one photocell and adjust the zero dial until the pen is at exactly 0% transmission or ∞ on the logarithmic paper. (It is rarely necessary to check this zero position once the colorimeter and recorder have warmed up. Once every hour or so is quite sufficient.)

Again illuminate both cells and readjust the 100% dial slightly until the pen reads a little to the left of 100% transmission mark or the 0 on the logarithmic paper. The colorimeter is now ready for use but plenty of time (5–10 min) should be allowed to ensure that the blank has a stable value. The blank requires redetermining at more frequent intervals than either the standards or the 0% transmission check, but only experience with a method enables the operator to decide how frequently.

2. USE OF RANGE EXPANDERS

These auxiliary circuits can be purchased from the Technicon Instruments Corporation and are used for the phosphate and ammonia methods where maximum sensitivity is required. Linear (0–100) and not logarithmic (0– ∞) chart paper *must* be employed. The range expander has four positions: 1, 2, 4, and 10. *Always turn to position 1 when adjusting to 0% transmission. Turn to the desired sensitivity position (generally 4 or 2) before adjusting to 100%.* These two operations are most important, as failure to do them correctly will result in false readings which are often difficult to detect.

3. CALCULATIONS USING PROCEDURE A

Readings are presented directly in logarithmic units for silicate or nitrate and these values, with blanks subtracted, are directly proportional to concentration. A proportionality factor is obtained by standardization with known amounts of nitrate or silicate and is given by:

$$F = \frac{\mu\text{g-at/liter in standard}}{\text{Reading of standard} - \text{Reading of standardization blank}}$$

The calculation for use with phosphate or ammonia, when the range expander is used, is less straightforward. The logarithmic units cannot be read directly but must be calculated from the range expander value, R , and the reading of the transmission chart paper. If this reading is x units with an expander position R , when the blank reading is b (generally near to 100 units) then:

$$\text{Logarithmic unit} = \log_{10} \frac{(100 R - 100 + b)}{(100 R - 100 + x)}$$

This expression (which incorporates the blank) is evaluated for each point and used, together with a standardization factor, to calculate concentrations exactly as for nitrate and silicate.

The range expander effectively moves the zero, 1, 2, 4, or 10 chart lengths from the right hand side of the recorder paper and hence one works with 50–100, 75–100, or 90–100 units of transmission instead of the more normal 100 units. Thus with a setting of 4, the zero on the chart is no longer zero transmission but 75 out of 100 units, i.e., a logarithmic unit of 0.125, $\log \frac{100}{75}$ rather than infinity, $\log \frac{100}{0}$.

Because of a property of logarithms, the number of chart divisions *measured from the right hand side of the paper* is proportional to the concentration of nutrient with up to about 20 units for a range expander setting of 2, 40 units with a range expander setting of 4, and 100 units (full scale) with a range expander setting of 10; but it is generally best, with the 2 and 4 settings, to convert standard and sample readings to logarithms before making calculations. The 10 setting is difficult to use at sea because of problems of background noise.

The time at which the pen reaches a given value on the chart in Procedure A lags behind the time when the sample was taken from the sea and it is necessary to know this lag time before a correlation can be made of the concentrations read from the chart and the *in situ* values of nutrients.

4. CALCULATIONS USING PROCEDURE B

The same general principles for calculating results apply as with Procedure A. Blanks must always be run at the end of each profile. Standardization twice a day (morning and evening) is generally sufficient. As with Procedure A there is a lag between sampling and presentation which must be known with precision.

5. CALCULATIONS USING PROCEDURE C

Samples taken from the turntable are alternated with blanks, the turntable generally being programmed to suck samples and blanks, each for 3 min. Three minutes is nearly sufficient for the recorder pen to reach full deflection, but even if this is not the case the height between the top of the trace of a sample and the *minimum of the succeeding (not preceding) blank* is proportional to the concentration of nutrients when logarithmic units are used. These are read directly from the chart paper in the case of nitrate and silicate, and by means of the calculation given above in the case of phosphate and ammonia. Standards, and blanks for standards, are placed on the turntable as if they were samples. Generally a duplicate standard and one blank placed at the beginning, middle, and end of a batch of samples will be found sufficient. Factors for use with Procedure C may be expected to be from 10 to 20% greater than those found using Procedure B because a full deflection may not be attained from a sample before the adjacent washing blank is sensed.



II.15.II. NUTRIENT ANALYSIS

II.15.II.1. NITRATE

METHOD

A. CAPABILITIES

Procedure A:	<i>Range: 0.1–7 $\mu\text{g-at N/liter}$</i>
Procedure B:	<i>Range: 0.5–35 $\mu\text{g-at N/liter}$</i>
Procedure B– (sensitive):	<i>Range: 0.25–18 $\mu\text{g-at N/liter}$</i>
Procedure C:	<i>Range: 0.6–40 $\mu\text{g-at N/liter}$</i>

(Can be extended if required in Procedure C by first diluting with an equal volume of water.)

Note: Do not use readings in excess of a logarithm 1.2. If more adsorption is encountered change from sensitivity B- (sensitive) to B or from A to B- (sensitive). With Procedure C, dilute the samples on the turntable with an equal volume of distilled water if more than about 35 $\mu\text{g-at N/liter}$ is anticipated.

B. REAGENTS

1. CADMIUM

Use filings of pure or 99% pure cadmium metal that have passed a 32-mesh sieve but are held on a 60-mesh sieve (*ca.* 0.25–0.50 mm). This rather close sizing is very important for good columns. Rinse the filings once or twice with a little clean diethyl ether to remove grease and dirt. Allow the metal to air-dry and store in a well-stoppered bottle.

2. COPPER SULPHATE STOCK SOLUTION

Dissolve 20 g of copper sulphate pentahydrate in 100 ml of distilled water. Store in glass or plastic.

3. AMMONIUM CHLORIDE STOCK SOLUTION

Dissolve 340 g of analytical reagent quality ammonium chloride in 3900 ml of distilled water. Add 50 drops of BRIJ, a detergent supplied by the Technicon Instruments Corporation.

4. DILUTE AMMONIUM CHLORIDE SOLUTION

Procedure A: Use stock solution unchanged.

Procedure B– (sensitive): Dilute 425 ml of stock solution to 1000 ml with distilled water and add 10 drops of BRIJ.

Procedures B and C: Dilute 240 ml of stock solution to 1000 ml with distilled water and 10 drops of BRIJ.

5. SULPHANILAMIDE SOLUTION

See II.6,E.4.

6. *N*-(1-NAPHTHYL)-ETHYLENEDIAMINE DIHYDROCHLORIDE SOLUTION

See II.6,E.5.

7. PREPARATION OF REDUCTION COLUMNS

Note: These should not be filled longer than a week or two ahead of the time for their use. A column is replaced when the factor increases, generally quite dramatically over the course of

a day. Good columns can last for at least 1-2 weeks of continuous use. A column should be disconnected from the main stream and closed by its loop of tubing after washing through with a blank. Do not connect the reductant column into the main stream when starting the auto-analyzer, until all air has been removed from the tubing. Some air will inevitably collect in the column during use but this seems to do no harm if kept to a minimum.

Prepare two, or at most three, columns as follows:

Clamp a column upright, with its tapered end, having the tubing and rubber bung attached, facing downwards. Fasten the bung above the level of the open end of the column so that the column can be filled with liquid.

In a small beaker weigh out 6 g of cadmium for each column to be filled. Dilute the copper sulphate stock solution 10-fold with water and then add this solution to the cadmium filings in the ratio of 10 ml for each gram of filings. Stir vigorously until all colour leaves the solution and fine copper particles begin to enter the supernatant liquid.

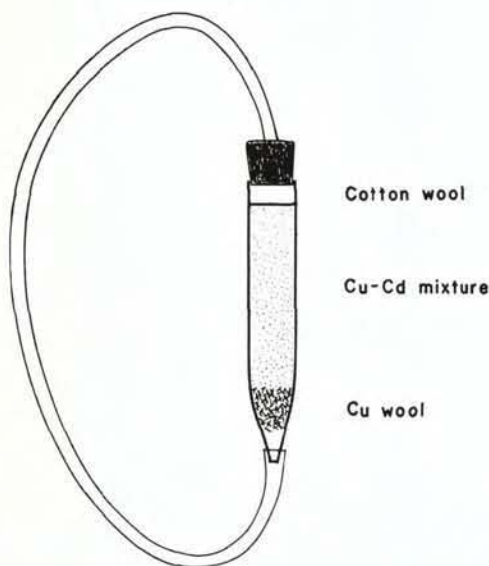

FIG. 3. NO_3 reduction coil ($\frac{1}{2}$ actual size).

Add a small ball of fine copper "wool" turnings to the column to make a plug at the tapered end and press it into place. Fill the column with the supernatant liquid from the beaker of filings, and then add filings a little at a time with periodic brisk tapping of the column to compact the metal. When the filings are within 4 mm of the top and well compacted, add a small plug of absorbent cotton wool, and then firmly stopper the column. Keep the column closed with the loop of tubing when not in use. The filled column is sketched in Fig. 3. Ensure that initially there is *no* air trapped in the metal filings. If this is the case, repack.

New columns require a period of running-in before maximum reduction is achieved, although this normally does not require more than about 1 hr. Be on guard during this period for the carryover of a little copper dust which may settle in the colorimeter cell and require removing.

C. PUMPING RATES AND MIXING

Directions	Procedures			
	A	B	B- (sensitive)	C
Sample (ml/min)	2.5	0.60	1.20	0.60
Dilution water (ml/min) (high quality distilled water)	0	2.50	2.00	2.50
Dilute ammonium chloride solution (ml/min)	0.32	0.32	0.32	0.32
Reduction column		all procedures		
Sulphanilamide (ml/min)	0.16	0.16	0.16	0.16
Air (ml/min)	1.20	1.20	1.20	1.20
Mix in one long coil		all procedures		
<i>N-naphthyl</i> (ml/min)	0.16	0.16	0.16	0.16
Mix in one long coil and send to colorimeter.		all procedures		

D. COLORIMETER

5-cm cell pumped out at 2.00 ml/min. 5400 Å filters. Selenium photocells.

E. BLANKS

Use distilled water. There is a slight salt error but the quantity of nitrate is generally so small in the blank that failure to correct for the salt effect causes no significant error.

F. CALIBRATION

Because of salt effects standards should be made with surface sea water of low nitrate content or with a synthetic sea water containing 620 g sodium chloride, 200 g of magnesium sulphate heptahydrate, and 5 g of sodium bicarbonate monohydrate per 20 liters of distilled water. The amount of nitrate in this sea water is generally too great to be neglected and a blank should be run on it when standardizing.

STANDARD SOLUTIONS

Dissolve 0.253 g of dried potassium nitrate, KNO_3 , in 1000 ml of distilled water. Store in a glass bottle with a few drops of chloroform as a preservative.

$$1 \text{ ml} \equiv 2.50 \text{ } \mu\text{g-at N}$$

For Procedure A add 1.00 ml, for Procedure B-- (sensitive) add 2.50 ml, for Procedure B and C add 5.0 ml of this concentrated standard to 500 ml of sea water to give standards of 5.0, 12.5, 25, and 25 $\mu\text{g-at N/liter}$, respectively.

PROCEDURE

Use the same day and correct the stable logarithm value for that of a standard-blank (sea water taken from the stock *at the same time* as the standard is prepared; *see above*) to calculate the value of the factor:

$$F = \frac{\text{concentration of nutrient}}{\text{corrected logarithm value}}$$

The approximate values of F for Procedures A, B— (sensitive), B, and C are 5, 13, 25, and 30, respectively.

II.15.II.2. NITRITE

This method is essentially the same as the nitrate method except that only Procedure A sensitivity is used, the reduction column is not connected, and the ammonium chloride reagent is unnecessary (although its presence does no harm). The range is about 0.025–2 $\mu\text{g-at N/liter}$ using a range expander at position 4 and the method should be standardized with nitrite in distilled water at a known concentration of about 1 $\mu\text{g-at N/liter}$.

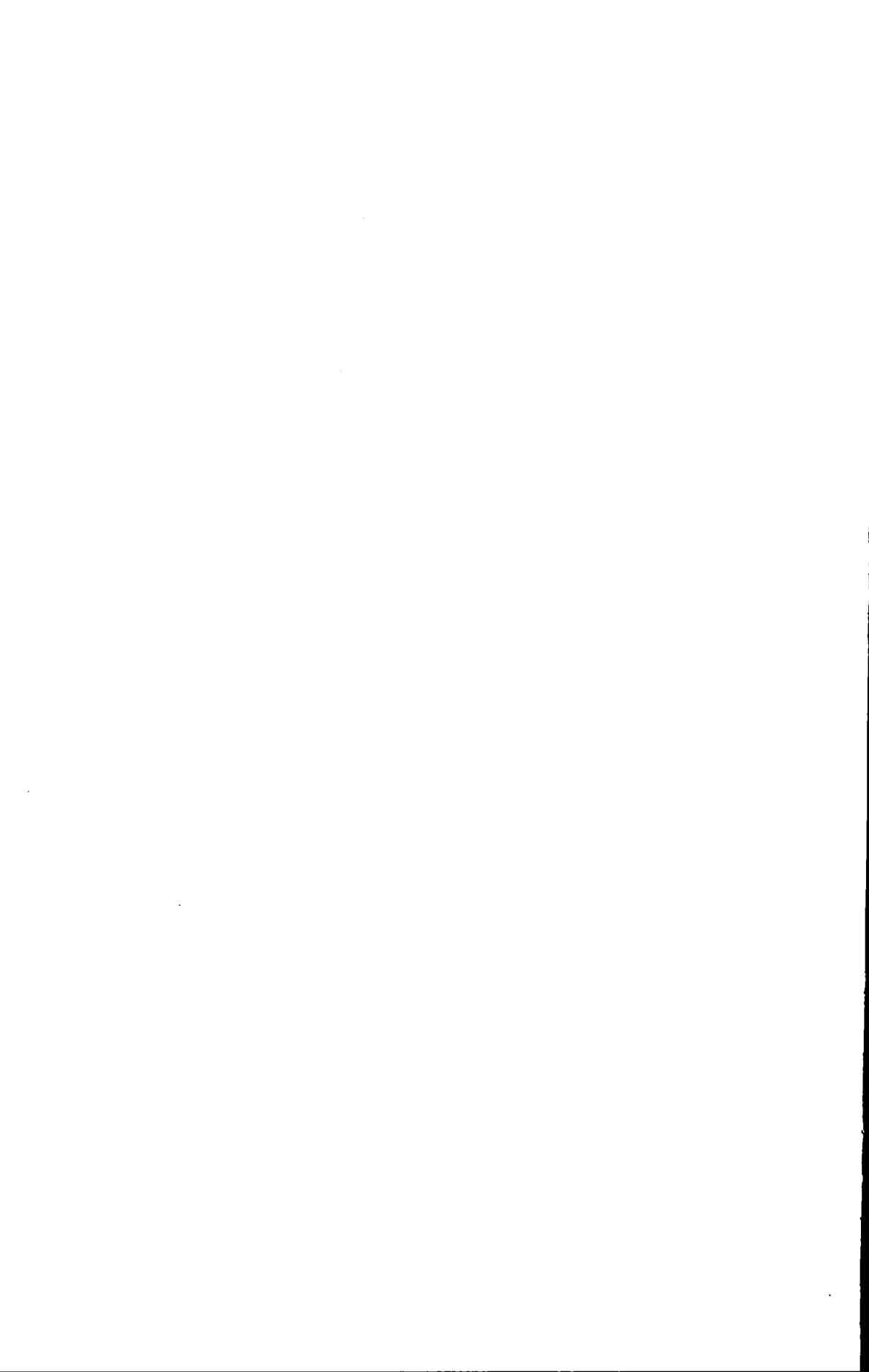

II.15.II.3. AMMONIA METHOD FOR THE AUTOANALYZER

A. CAPABILITIES

Procedures A, B, and C have the same (maximum) sensitivity with this method. A range expander (R) value of 4 should generally be used.

Procedures A and B: *Range: 0.15–3 µg-at N/liter*

Procedure C: *Range: 0.2–3.5 µg-at N/liter*

B. REAGENTS

1. ALKALINE CITRATE SOLUTION

Dissolve 400 g of analytical reagent quality sodium citrate, $\text{Na}_3\text{C}_6\text{H}_5\text{O}_7 \cdot 2\text{H}_2\text{O}$ and 20 g of analytical reagent quality sodium hydroxide Na OH. (dry pellets), in exactly 2,000 ml of deionized water.

2. SODIUM ARSENITE

Dissolve 20 g of sodium metarsenite in 1,000 ml of deionized water.

3. ACIDIFYING SOLUTION

Mix exactly 400 ml of analytical reagent quality concentrated hydrochloric acid (s. g. 1.18) with 600 ml of deionized water containing 20 g of sulphanilamide. The pH of the final effluent entering the colorimeter must be in the range 0.5–1.0. This should be checked with each new batch (either alkaline citrate or acidifying solution) and the strength of the acidifying solution adjusted if necessary until the pH is in the correct range.

4. SODIUM BROMIDE

Dissolve 5 g of sodium bromide, NaBr, in 200 ml of deionized water. Prepare this solution fresh at least every two weeks.

5. OXIDIZING REAGENT

Add 2 ml of sodium bromide to 400 ml of alkaline citrate solution, mix, and then add 4 ml of sodium hypochlorite. (The sodium hypochlorite solution is conveniently obtained as concentrated "CLOROX" and its strength should be checked, if in doubt, as described in the ammonia method, Method II.8.). The mixed reagent should be prepared fresh every day.

6. N-(1-NAPHTHYL)-ETHYLENEDIAMINE DIHYDROCHLORIDE

Prepare as in the Nitrate method, Method II.15.II.1.

C. PUMPING RATES AND MIXING

Directions for all procedures:

Sample 2.50 ml/minute

Oxidizing reagent—0.60 ml/minute

Allow solutions to mix in a length of 2 mm ID straight tubing 4-5 cm in length

Air—1.20 ml/minute

Mix in two long coils

Sodium arsenite solution—0.16 ml/minute

Mix in one short coil

Acid sulphanilamide solution—0.32 ml/minute

Mix in one short coil

N-(1 naphthyl) ethylenediamine—0.16 ml/minute

Mix in one long coil

D. COLORIMETER

5-cm cell pumped at 2.00 ml/minute. 5400 Å filters. Selenium photocells.

E. BLANKS

These are carried out on distilled and deionized water exactly as described above. There is no "salt error."

Note: *a*) To insure that the accumulated precipitate is removed from the coils after many hours of working, disconnect the reagents and pump a solution of concentrated HCl (50% v/v) through the tubing for ten minutes. Then wash the coils by pumping distilled water wash for a further 10 minutes.

b) There appears to be less interference by other amino compounds in this method than in the original Richards and Kletsch method from which it was (distantly) derived. Interferences (as ammonia) of the few compounds so far tested are:

- Urea—less than 5%
- Alanine—less than 5%
- Histidine—5%
- Glycine—10%
- Aspartic acid—20%

F. CALIBRATION

Prepare standards with natural or synthetic sea water, preferably the former (*see* II.14.II.1,F. *above*), and carry out a blank on this sea water along with the standard.

1. STANDARD SOLUTIONS

Dissolve 0.0535 g of ammonium chloride, NH_4Cl , in 1000 ml of distilled water. Store in a well-stoppered glass bottle with a few drops of chloroform as a preservative.

$$1 \text{ ml} \equiv 1.00 \text{ } \mu\text{g-at N}$$

For all procedures add 1.00 ml of this concentrated standard to 500 ml of sea water to give a standard of 2.0 $\mu\text{g-at N/liter}$.

2. PROCEDURE

Use the same day and correct the stable logarithm value for that of a standard-blank (sea water taken from the stock *at the same time* as the standard is prepared; *see above*) to calculate the value of the factor:

$$F = \frac{\text{concentration of nutrient}}{\text{corrected logarithm value}}$$

The approximate value of F for Procedures A and B will be 23 and for Procedure C, 28.

II.15.II.4. PHOSPHATE

METHOD

A. CAPABILITIES

Procedures A, B, and C have the same (maximum) sensitivity with this method. Generally a range expander (R) value of 4 should be used although in some fertile areas (Procedures A and B) and for all deep samples (Procedure C) it will be necessary to use an R value of 2. Any seeming advantages of using an R value of 10 are probably more apparent than real.

Procedures A and B: Range: 0.03–1.5 $\mu\text{g-at P/liter}$, ($R = 4$)
or
0.06–3.5 $\mu\text{g-at P/liter}$, ($R = 2$).
Procedure C: Range: 0.05–3.5 $\mu\text{g-at P/liter}$, ($R = 2$ or 4).

B. REAGENTS

1. MOLYBDATE SOLUTION

Dissolve 34 g of powdered ammonium paramolybdate in 1000 ml of distilled water. Add 400 ml of analytical reagent quality concentrated sulphuric acid a little at a time with mixing. Cool. Add 0.25 g of potassium antimonyl tartrate after *first dissolving the salt* in about 20–30 ml of water. Finally, add a further 2500 ml of water, mix the whole, and store in plastic. The solution is stable for many months in a well-stoppered bottle.

2. STOCK REDUCTANT

Dissolve 4.0 g of good quality ascorbic acid in 100 ml of acetone and 100 ml of distilled water. Add 4 ml of LEVOR IV (a detergent supplied by the Technicon Instruments Corporation) and keep the solution in a deep freeze or refrigerator. Do not keep more than 2 months, or more than 2 weeks if not refrigerated. The bottle should be *well stoppered* to prevent the loss of acetone.

3. REDUCING REAGENT

Add 20 ml of Stock Reductant to 100 ml of distilled water. The solution must be prepared freshly each day.

C. PUMPING RATES AND MIXING

Directions for all procedures:

Sample (2.50 ml/min)

Molybdate Solution (0.32 ml/min)

Reducing Reagent (0.16 ml/min)

Air (1.2 ml/min)

The reagents (and air) are added by small-bore side tubes to the main stream in three successive units butted against each other and held with the small-bore tubes in a vertical plane. The bubble pattern must be even.

Mix in one long mixing coil surrounding a quartz heating rod.

Mix in one unheated short coil and send to colorimeter. The solution is conducted to the colorimeter with the shortest practical length of glass tubing. Have the solution in contact with only the minimum possible amount of plastic until it

enters the flow-through cell. The temperature should be adjusted to about 75 C at the exit end of the long coil. The *coils must not* be exposed to drafts of cold air.

D. COLORIMETER

5-cm cell pumped out at 2.00 ml/min. 8850 Å filters. Silicon rectifier photo-cells. Range expander at position 2 or position 4.

E. BLANKS

Use distilled water. There is a slight salt error but this is ignored in the blank determination.

F. CALIBRATION

Because of salt effects, standards should be prepared with natural or synthetic sea water (*see* II.15.II.1,F. *above*) and a blank carried out on this sea water along with the standard.

1. STANDARD SOLUTIONS

Dissolve 0.068 g of dried potassium dihydrogen phosphate, KH_2PO_4 , in 1000 ml of distilled water. Store in a glass bottle with a few drops of chloroform as a preservative.

$$1 \text{ ml} \equiv 0.50 \text{ } \mu\text{g-at P}$$

For all procedures add 1.00 ml of this concentrated standard to 500 ml of sea water to give a standard of 1.0 $\mu\text{g-at P/liter}$.

2. PROCEDURE

Use the same day and correct the stable logarithm value for that of a standard-blank (sea water taken from the stock *at the same time* as the standard is prepared; *see above*) to calculate the value of the factor:

$$F = \frac{\text{concentration of nutrient}}{\text{corrected logarithm value}}$$

The approximate value of F for Procedures A and B will be 14 and for Procedure C, 17.

II.15.II.5. SILICATE

METHOD

A. CAPABILITIES

Procedure A:	<i>Range: 0.3–15 $\mu\text{g-at Si/liter}$</i>
Procedure B:	<i>Range: 1.3–80 $\mu\text{g-at Si/liter}$</i>
Procedure B- (sensitive):	<i>Range: 0.7–40 $\mu\text{g-at Si/liter}$</i>
Procedure C:	<i>Range: 1.5–90 $\mu\text{g-at Si/liter}$ (extended to 180 $\mu\text{g-at Si/liter}$ if samples are first diluted with an equal volume of water)</i>

Note: Do not use reading in excess of a logarithm 1.2. If more absorption is encountered, change from sensitivity B- (sensitive) to B, or from A to B- (sensitive). With Procedure C, dilute the samples on the turntable with distilled water if more than about 80 $\mu\text{g-at Si/liter}$ is anticipated in the sample.

B. REAGENTS

1. STOCK MOLYBDATE SOLUTION

Dissolve 200 g of powdered ammonium paramolybdate in 4 liters of distilled water. Store the solution in a plastic bottle where it is stable indefinitely.

2. HYDROCHLORIC ACID 10%

Add 400 ml of concentrated hydrochloric acid reagent (sp gr 1.185) to 3600 ml of distilled water. Mix thoroughly and store in a plastic bottle where the solution is stable indefinitely.

3. STOCK STANNOUS CHLORIDE SOLUTION

Dissolve 40 g of good quality stannous chloride dihydrate in a mixture of 25 ml of concentrated hydrochloric acid and 25 ml of distilled water, warming slightly if necessary. Store in a small glass bottle tightly stoppered by a rubber bung. The solution is stable for many months if no air is allowed to enter the bottle unnecessarily.

4. TARTARIC ACID SOLUTION

Dissolve 400 g of tartaric acid in 3800 ml of distilled water in a plastic bottle. Add a few drops of chloroform as a preservative and stopper the bottle tightly.

5. MOLYBDATE REAGENT

Mix 80 ml of stock molybdate solution with 120 ml of 10% hydrochloric acid. Use for only a few days, discarding when a white precipitate forms.

6. REDUCING REAGENT

Dilute 2.5 ml of stock stannous chloride to 100 ml with 10% hydrochloric acid in a glass bottle. Prepare afresh each day.

C. PUMPING RATES AND MIXING

Directions	Procedures			
	A	B	B- (sensitive)	C
Sample (ml/min)	2.5	0.60	1.20	0.60
Dilution water (ml/min)	0	2.50	2.00	2.50
Molybdate reagent (ml/min)	0.16	0.16	0.16	0.16
Air (ml/min)	1.20	1.20	1.20	1.20
Mix in one long coil plus one short coil.			all procedures	
Tartaric acid solution (ml/min)	0.42	0.42	0.42	0.42
Mix in one short coil.			all procedures	
Reducing reagent (ml/min)	0.10	0.10	0.10	0.10
Mix in one long coil and send to colorimeter.			all procedures	

D. COLORIMETER

5-cm cell pumped out at 2.00 ml/min. 8200 Å filters. Silicon rectifier photocells.

E. BLANKS

Use distilled water. There is a slight salt error but the quantity of silicate in the blank is generally so small that failure to correct for the salt effect causes no significant error.

F. CALIBRATION

Because of salt effects, standards should be prepared with natural or synthetic sea water (see II.15.II.1.F. above) and a blank carried out on this sea water along with the standard.

1. STANDARD SOLUTIONS

This is prepared as described in II,5.H.1.

$$1 \text{ ml} \equiv 5 \text{ } \mu\text{g-at Si}$$

For Procedure A add 1.00 ml, for Procedure B- (sensitive) add 2.5 ml, for Procedure B add 5.0 ml, and for Procedure C add 5.0 ml of this concentrated standard to 500 ml of sea water to give standards of 10.0, 25.0, 50, and 50 $\mu\text{g-at Si/liter}$ respectively.

Note: The bottle holding the dilute standard must be plastic. All the above standards must be prepared afresh each day but they are mutually compatible, i.e., a mixed nitrate, ammonia, phosphate, and silicate standard can be used as one solution.

2. PROCEDURE

Use the same day and correct the stable logarithm value for that of a standard-blank (sea water taken from the stock at the same time as the standard is prepared; see above) to calculate the value of the factor:

$$F = \frac{\text{concentration of nutrient}}{\text{corrected logarithm value}}$$

The approximate values for F for Procedures A, B- (sensitive), B, and C are 14, 34, 68, and 75, respectively.

PART III. DETERMINATION OF SOLUBLE ORGANIC MATTER

III.1. DETERMINATION OF MONOPHOSPHATE ESTERS

INTRODUCTION

At certain times of year in most sea areas a considerable fraction of the total soluble phosphorus present in sea water will not react with molybdate in the cold. This "unreactive" phosphorus, however, is not necessarily all unavailable as a source of the element for marine phytoplankton and there is evidence that simple sugar phosphates and other monophosphate esters can be used. The following technique (Solórzano and Strickland, in Harold Barnes [ed.] *Some Contemporary Studies in Marine Science*, p. 665-674, 1966) gives a rapid and convenient method for detecting monophosphate esters and some fraction of any linear inorganic polyphosphates that may be present in sea water. (Refer to Heppel, Harkness, and Hilmoe, *J. Biol. Chem.*, 237: 841, 1962 for an account of substrate specificity.) There is little or no reactivity with highly condensed polynucleotides or with inorganic pyrophosphate. An identical technique to that described below but using 0.1 unit of inorganic pyrophosphatase will give any pyrophosphate in sea water but we have so far not detected this compound.

Determinations are best carried out at sea at the same time as the determination of reactive phosphate but samples can be stored deep-frozen or preserved by the addition of about 0.5 ml of pure chloroform per 100 ml of sea water.

METHOD

A. SPECIAL REAGENTS

1. BUFFER SOLUTION

Dissolve 25 g of Tris in about 100 ml of distilled water. Add 25% v/v hydrochloric acid carefully until the pH recorded by a pH meter is between 8.0 and 8.2 and then dilute the solution to 250 ml with water and store it in a well-stoppered bottle.

2. ENZYME SOLUTION

Use best quality chromatographically pure bacterial (*E. coli*) alkaline phosphatase such as that obtainable from the Worthington Biochemical Corporation, Freehold, New Jersey, USA. The stock enzyme (ca. 20 units/mg) should be stored at near to 0 C in a refrigerator. Transfer sufficient enzyme solution with a hypodermic syringe into 100 ml of distilled water to give a solution:

$$1 \text{ ml} \approx 1 \text{ enzyme unit}$$

The solution is stable for at least 4 weeks in glass when stored at about 5 C.

A check on the strength of the dilute enzyme solution should be made by adding

5 $\mu\text{g-at P}$ /liter of phosphorus as ribose-5-phosphate to low phosphate sea water and carrying out the analysis described below with 1 and 2 units of enzymes. The increment of liberated phosphate should be the same in both determinations and equivalent to an extinction of about unity. Prepare the sugar phosphate solution from the pure barium (trihydrate) salt dissolving 10.5 mg in 100 ml of distilled water.

$$1 \text{ ml} \equiv 0.25 \mu\text{g-at P}$$

B. PROCEDURE

Add to 50 ml of a seawater sample 1.0 ml of tris buffer solution and 1.0 ml of enzyme solution. Allow the mixture to stand at between 25 C and 30 C for 2 hr. Continue the determination exactly as in the standard reactive phosphate method using 5 ml of mixed reagent. Multiply the extinction by 1.04 before calculating the phosphate content. An increase of corrected extinction above that obtained in a parallel determination of reactive phosphate indicates the presence of enzyme hydrolyzable compounds in the sample, an extinction increase of more than about 0.01 being significant in careful routine work.

C. DETERMINATION OF BLANK

Correct extinctions by the blank extinction on reagents obtained in the usual manner. An additional extinction correction may be required to allow for any inorganic phosphate present in the buffer and enzyme solution. This can be found by carrying out a blank determination on 50 ml of distilled water using 1.0 ml of buffer and 1.0 ml of enzyme solution. Any monophosphate esters present in the enzyme may not be detected by this procedure as magnesium is necessary for activation of the enzyme but we have found no evidence for such a blank. For safety the extinction obtained on low phosphate sea water should be determined with 1.0 and with 2.0 ml each of enzyme and buffer solutions. Any extinction increase (take the mean of at least three determinations with each level of reagent volume) may be assumed to be due to buffer and enzyme and should not exceed about 0.01 unit. This value is added to the inorganic reagent blank to give the final blank for correcting enzyme-hydrolysis extinctions.

III.2. DETERMINATION OF SOLUBLE ORGANIC PHOSPHORUS BY ULTRAVIOLET OXIDATION

INTRODUCTION

This method is based on the observation by Armstrong, Williams, and Strickland (*Nature*, 211: 481, 1966) that the exposure of oxygenated water to a high intensity of radiation of wavelength less than 2500 Å catalyzes the oxidation of all organic molecules containing phosphate-ester or phosphinic acid bonds. All the phosphorus is liberated as orthophosphate and this leads to a simple and elegant method, which is specific and very precise, for the estimation of organic phosphorus in sea water. Polyphosphate linkages are not broken and go undetermined, making it possible, for the first time, to distinguish between organic and polyphosphate compounds in sea water.

METHOD

A. CAPABILITIES

Range: 0.03–2.5 µg-at/liter.

1. PRECISION AT THE 0.5 µG-AT/LITER LEVEL

The correct value lies in the range:

Mean of n determinations $\pm 0.03/n^{\frac{1}{2}}$ µg-at/liter.

2. LIMIT OF DETECTION

The smallest amount of soluble organic phosphate that can be detected with certainty is about 0.03 µg-at/liter.

B. OUTLINE OF METHOD

Orthophosphate is determined on the sample by method II.2.I, before and after irradiation with light of a wavelength less than 2500 Å. All organic phosphorus-containing molecules are decomposed in the irradiated water to give orthophosphate. The difference between the orthophosphate contents of the irradiated and the untreated sample gives the amount of phosphorus initially in organic combination.

C. SPECIAL APPARATUS AND EQUIPMENT

Fused silica tubes of 110-ml capacity and the irradiation equipment specified in the NOTES ON APPARATUS section, and 130-ml capacity special polyethylene bottles as specified in II.2.I,C are required.

D. SAMPLING PROCEDURE AND SAMPLE STORAGE

See II.3,D.

E. SPECIAL REAGENTS

Reagents 1–5 inclusive as in II.2.I,E.1–5.

6. HYDROGEN PEROXIDE

Use an analytical reagent quality "30%" solution.

F. EXPERIMENTAL

PROCEDURE

1. Rinse a silica tube with a few milliliters of the filtered sample. Add about 105 ml to the tube and at the same time rinse and fill a 130-ml capacity special polyethylene bottle to the mark (Note *a*).

2. Add 1–2 drops of hydrogen peroxide to the tube (Note *b*), stopper, and mix. Irradiate the tube and its contents for 60 min (Note *c*).

3. Cool the tube to room temperature and use a few milliliters of its contents to rinse another 130-ml polyethylene bottle. Fill the bottle to the mark with the contents of the tube.

4. Measure the orthophosphate concentration of the sea water in both polyethylene bottles as described in II.2.I,F, paragraphs 2 and 3.

5. If E_2 is the extinction of the irradiated sample and E_1 is the extinction of the untreated sample, calculate the organic phosphorus concentration in microgram-atoms of phosphate phosphorus per liter ($\mu\text{g-at P/liter}$) from the expression:

$$\mu\text{g-at P/liter} = (E_2 - E_1) \times F$$

where F is a factor obtained as described in II.2.I,H (Note *d*).

NOTES

(*a*) The polyethylene bottle should be set aside in a cool, dark place whilst the irradiation takes place and this should not be delayed. If desired, to conserve sample, the method can be carried out in glass flasks using two 50-ml rather than two 100-ml aliquots. In this case only 5 ml of mixed reagent should be used.

(*b*) Oxidation requires oxygen gas dissolved in the sample and this is normally present in a sufficient concentration but, for surety, especially with deep samples, a drop or two of hydrogen peroxide should be added. This all decomposes during the irradiation and does not interfere with the colour development.

(*c*) One hour of irradiation has always been found to be sufficient but there would be no harm in increasing the time a little as a safeguard. We have seen no evidence that functioning lamps cease to be satisfactory with this phosphorus method, unlike the case with the method for nitrogen (III.3.II).

(*d*) Endeavor to read the spectrophotometer to the nearest 0.001 extinction unit. It is perhaps best, especially in waters containing more than 1 $\mu\text{g-at P/liter}$ of reactive phosphorus, to put the untreated sample in the cell normally used for distilled water and to read the irradiated sample against it (*cf.* III.3.II,F.5).

G. DETERMINATION OF BLANK

This is a "difference" method with no blank as such. The amount of phosphorus in 1–2 drops of peroxide is negligible or can be determined by irradiating two samples of synthetic sea water, one with and one without adding this reagent. Unless there are consistent differences in excess of an extinction of 0.005, the peroxide is not suspect.

III.3. DETERMINATION OF SOLUBLE ORGANIC NITROGEN

III.3.1. KJELDAHL DIGESTION

INTRODUCTION

The soluble organic nitrogen in sea water (the compounds passing a 0.5- μ filter) will rarely exceed 5–20 $\mu\text{g-at N/liter}$, i.e. 0.1–0.3 ppm. The determination of such amounts by a procedure applicable to routine analysis presents great difficulties and the ultraviolet light oxidation method described in III.3.II, below, is recommended if at all possible. For those laboratories where this irradiation equipment cannot be obtained a direct chemical approach may still be necessary. The "classical" combustion method of Krogh and Keys (*Biol. Bull.*, 67: 132, 1934) has marginal sensitivity and presents manipulative difficulties. A Kjeldahl treatment of a large volume of water, followed by distillation of ammonia, seems more practical (Robinson and Wirth, *J. Conseil, Conseil Perm. Intern. Exploration Mer*, 9: 187, 1934) and most forms of organic nitrogen in sea water are undoubtedly converted to ammonia. As mentioned in Part II.8, distillation has certain practical disadvantages and the evaporation of large volumes of sample is also undesirable. In view of the sensitivity of the direct method for ammonia just described, we decided to combine a Kjeldahl treatment of a relatively small volume of water (25 ml) with a determination of the ammonia in the resulting solid by the method of Part II.8. The present method has been "dove-tailed" exactly into that of Part II.8 to avoid duplication of reagents, etc. The ultimate limit of detection by any Kjeldahl method, however, will depend upon the reproducibility of the nitrogen "blank" found on reagents, mainly sulphuric acid. Present-day acid, made entirely by the "contact" process, no longer presents so serious a problem as appears to have been the case in the past but still imposes a definite limitation to the sensitivity of any procedure. As the amount of organic nitrogen in sea water is unlikely to be less than about 3 $\mu\text{g-at N/liter}$ the sensitivity of the present method is probably satisfactory.

METHOD

A. CAPABILITIES

Range: 0.8–15 $\mu\text{g-at/liter}$

1. PRECISION AT THE 8 $\mu\text{G-AT/LITER}$ LEVEL

The correct value lies in the range:

$$\text{Mean of } n \text{ determinations } \pm 1.2/n^{\frac{1}{2}} \mu\text{g-at/liter.}$$

2. LIMIT OF DETECTION

The smallest amount of organic nitrogen that can be detected with certainty is about 0.8 $\mu\text{g-at/liter}$.

B. OUTLINE OF METHOD

25 ml of filtered sea water are evaporated to dryness with excess sulphuric acid and any organic nitrogen is converted to ammonia by a Kjeldahl digestion. The residue is dissolved in water, neutralized, and the ammonia determined as in Part II.8.

C. SPECIAL APPARATUS AND EQUIPMENT

30-ml size pyrex Kjeldahl flasks. These flasks must be cleaned initially by steeping them in near-boiling sulphuric acid for several hours. They are then rinsed thoroughly with distilled water before use. If the flasks are washed with distilled water immediately after use and stored with their mouths covered by aluminum foil the sulphuric acid cleaning treatment need only be carried out at infrequent intervals, when contamination is suspected.

An ice- or a cold-water bath.

A micro-Kjeldahl rack and vent to take 30-ml Kjeldahl flasks and give suitably controlled heating. Several such units are available commercially.

125-ml Erlenmeyer flasks. These must be rinsed copiously with distilled water and drained *immediately* before use.

D. SAMPLING PROCEDURE AND SAMPLE STORAGE

Samples should be filtered within an hour or so of being taken from the sea, using equipment that has had a most thorough cleaning with detergent and been rinsed with distilled water to ensure the absence of organic matter. Filtered solutions should be stored in clean glass bottles and frozen at -20 C if the analysis has to be delayed for more than a few hours, but because of the danger of contamination by ammonia we suggest that the storage time be left to a minimum.

E. SPECIAL REAGENTS

1. DE-IONIZED WATER

See Part II.8,E.1.

2. DIGESTION MIXTURE

Dissolve 0.1 g of analytical reagent quality selenium dioxide, SeO_2 , in 500 ml of distilled water. Add 500 ml of special sulphuric acid (*see just below*) and cool the mixture to room temperature. Make to a volume of exactly 1000 ml with distilled water and store in a tightly stoppered glass bottle. Discard only if contamination is suspected. The quality of the sulphuric acid is all-important in this method. Analytical reagent quality concentrated acid (sp gr 1.84) must be used but not all such acid, even bottles from the same supplier, may be satisfactory. If special "low nitrogen" acid is available (less than 2 ppm of N) use this, otherwise check several bottles of high grade acid until one is found which gives blanks (duplicates) with extinctions less than 0.35 (*see Sect. G*). Once a satisfactory bottle of acid is found it should be set aside, *well stoppered*, and used only for this determination.

Note: Distillation of concentrated sulphuric acid, rejecting the first and last 10% of the distillate, greatly improves its quality for this purpose by reducing its blank value.

3. SODIUM HYDROXIDE SOLUTION

Rinse 80 g of analytical reagent quality sodium hydroxide, in pellet form, *very rapidly* with about 20 ml of water, so that only a few per cent of the alkali is lost by dissolution. Discard the rinsing. Dissolve the washed pellets in *de-ionized* water and make the volume to 500 ml. Store in a well-stoppered polyethylene bottle. The solution is stable in the absence of excessive carbonation but should be renewed if contamination is suspected.

4. DILUTE SULPHURIC ACID

Add 50 ml of special sulphuric acid (*refer to 2 above*) to 500 ml of de-ionized water. Store in a well-stoppered glass bottle and transfer a few milliliters at a time to a clean glass dropping bottle for use.

5. BROMOTHYMOL BLUE INDICATOR

Dissolve 0.1 g of the solid indicator in 100 ml of distilled water. Store in a dropping bottle.

6. ANTI-BUMPING GRANULES

We have found Hengar granules or Fisher's "Boileasers" to be satisfactory, provided they are pretreated by heating them in boiling or near-boiling concentrated sulphuric acid for 2–3 hr. After the acid treatment the granules should be boiled with two or three changes of water, rinsed thoroughly and oven-dried. The latter treatment is essential if their anti-bumping properties are to be restored.

The remainder of the reagents used in this method are identical with those used in Part II.8,E.2–8 inclusive.

F. EXPERIMENTAL

Note: *All* the precautions outlined in Part II.8, G.2 apply equally well to the following method and must be strictly observed if satisfactory results are to be obtained. In addition care must be taken to ensure that no inner glass surfaces of equipment used prior to the Kjeldahl oxidation are contaminated by dust or touched by hand.

PROCEDURE

1. Thaw out the sample, if necessary, and pipette 25 ml directly into a Kjeldahl flask. Add 2.0 ml of digestion mixture from a pipette or burette and one "Boileaser."

2. Heat the flask on the Kjeldahl heating rack until all water is removed and then digest the residue for a further 60 min at about 200 C to complete the reaction (Note *a*).

3. Cool the tube slightly and dissolve the residue in about 20 ml of de-ionized water, warming if necessary. Finally cool the solution in cold water, preferably in an ice bath, and add one drop of bromothymol blue indicator (Note *b*).

4. Titrate the solution in the flask with sodium hydroxide solution. Approach the end point (yellow to blue) with caution and try not to "overshoot" by more than a few drops of alkali. Rinse down the neck of the flask with de-ionized water and titrate, dropwise, with dilute sulphuric acid until the solution is *just* yellow again. (Note *c*).

5. Transfer the solution from the Kjeldahl flask to a clean, drained-dry, 50-ml measuring cylinder. Rinse the flask once or twice and make the total volume in the cylinder to exactly 50 ml. Transfer the solution to a well-drained 125-ml Erlenmeyer flask. Drain the cylinder thoroughly but *do not* wash. Add 1 ml of potassium bromide solution.

6. Continue as for the determination of ammonia exactly as described in Part II.8,F, using the oxidizing reagent specified for sea water and allowing the oxidation to proceed for 2.5 hr. Measure extinctions in a 5-cm cell.

7. Correct the measured extinction by subtracting a reagent blank obtained as described in Section G. Calculate the soluble organic nitrogen per liter ($\mu\text{g-at N/liter}$) from the expression:

$$\mu\text{g-at organic N/liter} = (\text{corrected extinction} \times F) - (\mu\text{g-at NH}_3\text{-N/liter})$$

where F is a factor obtained as described in Section H below and ($\mu\text{g-at NH}_3\text{-N/liter}$) is the amount of ammonia found in another aliquot of the same sample analysed as described in Part II.8. The correction for ammonia may be unnecessary except for the most precise work where ammonia concentrations are exceptionally high (above 1 $\mu\text{g-at N/liter}$).

NOTES

(a) About 30 min is required to evaporate the sample. After hydrochloric acid has been evolved sulphuric acid fumes will appear. The temperature should be adjusted so that the acid refluxes for 1 hr near the top of the bulb of the Kjeldahl flask. There should be very little loss of acid vapour from the mouth of the flask.

(b) The solution is cooled to prevent appreciable losses of ammonia during the brief period in which the liquid is alkaline.

(c) For the reason mentioned above, the time during which solutions are alkaline should be kept to a minimum. Ensure that all alkali is washed down from the neck of the flask before the dilute acid is added. Similarly make sure that no acid is held up in the neck of the flask. Rinse down the neck and check on the stability of any end point.

G. DETERMINATION OF BLANK

A blank determination must be carried through in duplicate with each batch of samples being analysed. As many samples as practical may be evaporated and oxidized at one time but the flasks should be covered by foil until ready for analysis.

Carry out the method exactly as described in Section F.1–6, omitting the sea water and replacing it by about 5 ml of de-ionized water, the ammonia content of which is assumed to be negligible. The extinction should not exceed 0.3–0.35 on a 5-cm cell. For this blank to be representative of samples of all salinities the assumption must be made that the sodium hydroxide solution introduces a negligible amount of ammonia. This appears to be justified with good quality alkali but the solution can always be boiled to remove ammonia if its presence is suspected.

H. CALIBRATION

1. STANDARD NITROGEN SOLUTION

The efficiency of the Kjeldahl oxidation in this method appears to be as great as in any other so that there is little point in using an organic nitrogen source as a standard.

Dissolve 0.330 g of good quality dry ammonium sulphate in 100 ml of water in a measuring flask. Store this solution in a well-stoppered glass bottle with about 1 ml of chloroform as a preservative.

$$1 \text{ ml} \equiv 50 \mu\text{g-at N}$$

Dilute 5.00 ml of this solution to 1000 ml with distilled water. Use at once for calibration and do not store.

1 ml \equiv 0.25 $\mu\text{g-at N}$

1 ml \equiv 10 $\mu\text{g-at N/liter}$ in 25 ml of seawater sample

2. PROCEDURE

Add 25 ml of de-ionized water, 2.0 ml of digestion mixture, and a "Boileaser" to each of five flasks. To three flasks add 1.00 ml of dilute standard and carry out the determination as described in Section F.2-6 inclusive. Calculate the factor F from the expression:

$$F = \frac{10.0}{E_s - E_b} = ca. 15$$

where E_s is the mean extinction of the three standards and E_b the mean extinction of the two blanks. To allow for slight losses and other slight discrepancies, it is best to determine F by taking solutions through the entire procedure in this manner. For surety F should be determined whenever a new batch of reagents is prepared but experience may show that a less frequent determination is adequate.



III.3.II. DETERMINATION OF SOLUBLE ORGANIC NITROGEN BY ULTRAVIOLET OXIDATION

INTRODUCTION

This method is based on the observation by Armstrong, Williams, and Strickland (*Nature*, 211: 481, 1966) that the exposure of oxygenated water to a high intensity of radiation of wavelength less than 2500 Å catalyzes the oxidation of most organic molecules containing nitrogen to give a nitrate-nitrite mixture. This leads to a simple and elegant method for the determination of organic nitrogen in sea water. The method is so much more convenient and precise than the Kjeldahl approach that we strongly recommend it, even although there are some inherent errors and a doubt exists as to its applicability to certain nitrogenous compounds.

METHOD

A. CAPABILITIES

Range: 0.25–15 µg-at/liter.

1. PRECISION AT THE 5 µG-AT/LITER LEVEL

The correct value lies in the range:

Mean of n determinations $\pm 0.25/n^{\frac{1}{2}}$ µg-at/liter.

Note: The range and precision depends very much upon the amount of nitrate in the water. The above applies to near-surface waters with less than about 10 µg-at/liter. In deeper waters the precision is much poorer. In deep Pacific waters the value for P (*see* NOTE ON STATISTICAL LIMITS) is little better than 0.75 µg-at N/liter.

B. OUTLINE OF METHOD

Nitrate (plus nitrite) is determined on the sample by method II.6 before and after irradiation with light of a wavelength less than 2500 Å. Organic nitrogen compounds (and ammonia, for which a correction must be made) are oxidized to nitrate plus nitrite. The difference between the value for nitrate plus nitrite on samples before and after irradiation is therefore a measure of the amount of nitrogen initially present in organic combination.

C. SPECIAL APPARATUS AND EQUIPMENT

Fused silica tubes of 110-ml capacity and the irradiation equipment specified in the NOTES ON APPARATUS section. Special equipment needed for nitrate analysis (*Refer to* II.6,C).

D. SAMPLING PROCEDURE AND SAMPLE STORAGE

See II.6,D.

E. SPECIAL REAGENTS

Reagents 1–5 inclusive as per II.6,E.1–5.

6. HYDROGEN PEROXIDE

Use an analytical reagent quality "30%" solution.

F. EXPERIMENTAL

PROCEDURE

1. Rinse a silica tube with a few milliliters of the filtered sample. Add about 105 ml to the tube and at the same time rinse a 100-ml measuring cylinder and a 125-ml Erlenmeyer flask with the sample, shake out excess water, and measure out 100 ml of sample into the flask (Note *a*).

2. Add 1–2 drops of hydrogen peroxide to the silica tube (Note *b*), stopper, and mix. Irradiate the tube and its contents for 3 hr (Notes *c* and *d*).

3. Cool the tube to room temperature and use a few milliliters to rinse the 100-ml cylinder and a second Erlenmeyer flask. Add 100 ml of irradiated sample to the flask.

4. Measure the nitrate content of the irradiated and untreated samples as described in II.6,F.1–4 using *the same* reductor column for both solutions (Note *e*).

5. Fill the 1-cm or 0.5-cm spectrophotometer cell normally used for the distilled water blank with the solution from the un-irradiated sample. Measure the extinction of the irradiated sample against this solution (Note *f*). If this extinction is *E*, calculate organic nitrogen present from the expression:

$$\mu\text{g-at N/liter} = (E \times F) - (C + x)$$

where *F* is a factor determined as described in Section H (*below*), *C* is the concentration of ammonia in the sample and *x* has the value of 0.5, 0.75, or 1 when the nitrate content of the *untreated* sea water is in the range 15–25, 25–35, or 35–45 $\mu\text{g-at N/liter}$, respectively (Note *g*).

NOTES

(*a*) Set the flask aside in a cool dark place. Do not delay irradiation of the other aliquot.

(*b*) Oxidation requires oxygen gas dissolved in the sample and is markedly more rapid at high oxygen concentrations. This is ensured by the addition of hydrogen peroxide. The oxidation rate is *pH*-dependent and is at about a maximum at seawater *pH*. If fresh water samples are ever analyzed a little bicarbonate should be added to ensure that the *pH* is in the range 6–8.5.

(*c*) The oxidation of organic nitrogen compounds and ammonia to nitrate is slower than the rate of orthophosphate liberation (*see* III.2) and a full 3 hr is required. For reasons we do not understand, some lamps, although still functioning, cease to be so active in the oxidation of nitrogen compounds and we suggest, therefore, a periodic check (*see* Section H).

(*d*) A large number of organic nitrogen compounds tested by us have been quantitatively converted to nitrate by this method, including several heterocyclic molecules. It seems fairly certain, therefore, that most of the metabolic products of the plankton will be measured but urea is surprisingly resistant and one is left suspecting that other materials, which do not react, may exist in sea water. We do not believe this is likely to introduce a serious error, however, and the Kjeldahl and UV methods when compared directly indicate no systematic differences. Ammonia is qualitatively oxidized in 3 hr and a correction must be made for the most precise work (*see* Section F.5 *above*). As “ammonia” is often determined as ammonia plus amino acids (*see* II.8) and is generally only a small fraction of the total organic nitrogen, we have rarely made this correction.

(*e*) This ensures the maximum precision because the factor will not change between the two determinations, as might be the case were two different columns used.

(*f*) This method of extinction measurement ensures a high precision on the Beckman and similar spectrophotometers as small differences are read directly on the most open part of the extinction scale. It will generally be necessary to open the slit width on the spectrophotometer

to get an adequate sensitivity. In any case, if the extinction of the irradiated solution against water exceeds about 1.0 ($25 \mu\text{g-at NO}_3\text{-N/liter}$) then 0.5-cm cells should be used and the measured extinction multiplied by two before calculations are made.

(g) For reasons we do not understand about one half the nitrate in a sample is reduced to nitrite when samples of high nitrate and low organic nitrogen content are irradiated. Because nitrite is destroyed to the extent of about 5% in the cadmium column (*see* II.6) a slight error will result, as this nitrite will not be present in the untreated sample. The quantity χ is used in an attempt to correct this trouble. It is not a very precise correction but, in deep water, it is probably better to use it than make no correction at all. For near-surface samples with high organic nitrogen and nitrate contents less than about 10–20 $\mu\text{g-at N/liter}$ no such correction should be attempted.

G. DETERMINATION OF BLANK

This is a "difference" method with no blank as such, an outstanding advantage over the Kjeldahl method.

H. CALIBRATION

The factor for a given column is determined as described in II.6,H.

Because of the uncertainty of lamp efficiency mentioned in Section F, Note c, we check every few days of use by irradiating synthetic sea water (II.6,H.1) to which is added α,α' -dipyridyl as a convenient source of organic nitrogen. An organic nitrogen blank must be made on the synthetic sea water. We add the α,α' -dipyridyl as 1.0 ml of a stock solution to 99 ml of sea water. The stock is prepared by dissolving 0.117 g of base in 400 ml of water with stirring and diluting it to 1000 ml.

$$1 \text{ ml} \equiv 1.5 \mu\text{g-at N}$$

The lamp is suspect if a rough check, made as described above, leads to less than 90% of theoretical recovery ($15 \mu\text{g-at N/liter}$).



III.4. DETERMINATION OF SOLUBLE ORGANIC CARBON

INTRODUCTION

This procedure is taken from Menzel and Vaccaro (*Limnol. Oceanog.*, 9: 138, 1964) with some modifications. The method is probably the most precise and sensitive of the several methods which have been published in the last decade but experience and care are required if its full potentialities are to be realized. For this reason we have described the procedure in considerable detail. The method is not as difficult and exacting, however, as might be supposed on first reading. There is still some doubt, at least in theory, as to whether all the dissolved organic matter in sea water is fully oxidized because the only testing of the efficiency of oxidation has been with added compounds of known composition. As well as the substances treated by the original authors, the present writers and their colleagues have, by now, tested the procedure with a wide variety of compounds and we find it difficult to believe that any significant component of the organic matter in the sea can be escaping detection, although this possibility should always be borne in mind.

METHOD

A. CAPABILITIES

Range: 0.09–6 mg C/liter

1. PRECISION AT THE 1.0 MG/LITER LEVEL

The correct value lies in the range:

Mean of n determinations $\pm 0.06/n^{1/2}$ mg/liter.

2. LIMIT OF DETECTION

The smallest amount of organic carbon that can be detected with certainty is about 0.09 mg/liter.

B. OUTLINE OF METHOD

To 5 ml of filtered sample in a 10-ml ampule are added phosphoric acid and potassium persulphate. All inorganic carbonate is removed by passing nitrogen gas through the sample, and organic carbon in the water is oxidized to carbon dioxide by heating the sealed ampule to 130 C for 40 min. This carbon dioxide is then estimated by dispelling it from the ampule in a stream of nitrogen gas which is passed through a non-dispersive infrared absorption gas analyzer. (See Fig. 4 for diagram of apparatus.)

C. SPECIAL APPARATUS AND EQUIPMENT

(See Section G for cleaning precautions.)

10-ml KIMAX or similar glass ampules.

10-ml hypodermic syringe.

1.0-ml tuberculin-type hypodermic syringe.

Small open glass tube fastened at right angles on a piece of glass rod to make a scoop holding 200 mg of potassium persulphate ($\pm 5\%$).

Small glass funnel, to fit into the top of a 10-ml ampule, for introducing per-sulphate.

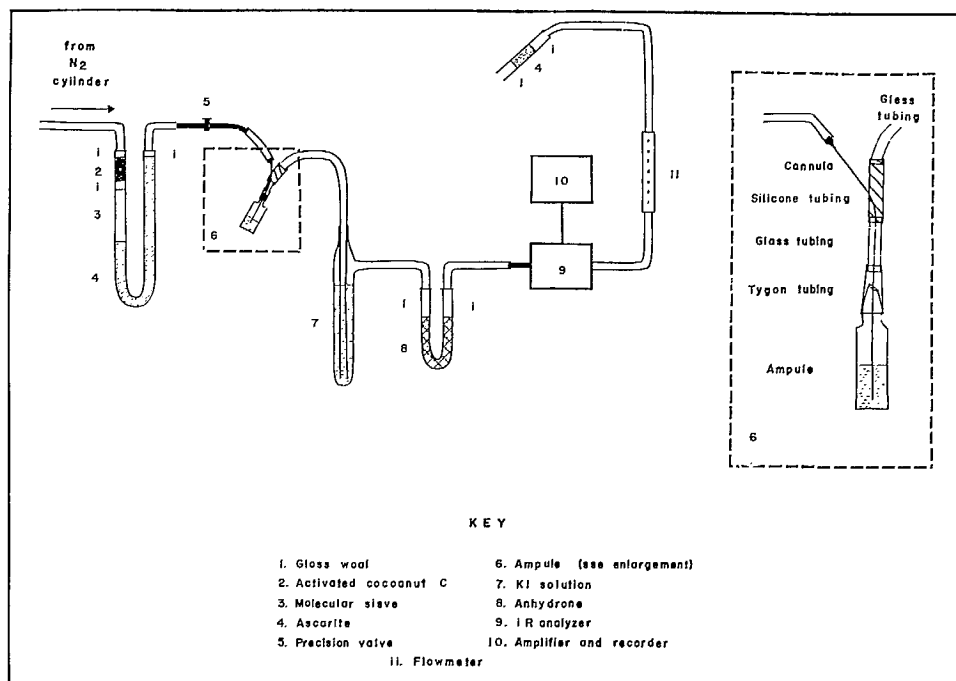

FIG. 4. Apparatus for determination of soluble organic carbon.

Silicone rubber tubing, $\frac{3}{32}$ -inch wall of $\frac{3}{16}$ -inch bore (many feet).

Tygon tubing to fit snugly over the top of a 10-ml ampule (a few short lengths).

Micrometer precision metering valve, such as that obtainable from the Nuclear Products Company of Cleveland, Ohio, USA.

"Swagelok" tube fittings, as obtained from the Crawford Fitting Company of Solon, Ohio, USA, fitted to brass tube of $\frac{1}{4}$ - or $\frac{1}{8}$ -inch external diameter.

A gas flow meter with a maximum range of 500 ml/min.

A stainless steel cannula, 15 cm long and 1 mm wide, sharpened at one end and braised at the other end to a $\frac{1}{4}$ -inch OD brass tube.

Beckman model 15-A infrared analyzer equipped with 7-inch cells.

10-mv full scale recorder.

It is convenient to have an integrator on the recorder such as that made by the Disc Instrument Company of Santa Ana, California, USA.

Autoclave capable of giving 24 psi of steam (130 C).

Note 1: The general layout of the apparatus is shown in the diagram. The brass tubing and Swagelok fittings are not essential and can be replaced by silicone tubing. The precision metering valve is essential. Details for working and maintenance of the Beckman IR analyzer should be obtained from the manufacturer.

Note 2: It is best to do most operations (*see below*) in some form of protective hood or

"dry-box" to minimize dust contamination but the necessity for this is not absolute and will depend upon laboratory conditions.

D. SAMPLING PROCEDURE AND SAMPLE STORAGE

See Section G below for precautions for cleaning apparatus. Samples should be filtered through well-washed membrane or, preferably, glass filters. If only small volumes of sample are available use an ignited glass filter previously washed with a few milliliters of sample. Store the samples in small, clean glass-stoppered glass bottles or in ampules with their mouths covered by aluminum foil. If storage periods are to exceed a few hours freeze the samples at -20 C protected from the possibility of contamination by organic vapours.

E. SPECIAL REAGENTS

1. Cylinder nitrogen with reduction valve and pressure gauges.
2. Activated coconut charcoal, 8- to 12-mesh.
3. Chromatographic grade "molecular sieve", 60- to 80-mesh.
4. Ascarite soda-lime, 20- to 30-mesh.

5. POTASSIUM IODIDE SOLUTION

Dissolve 200 g potassium iodide, KI, in 500 ml of 10% v/v sulphuric acid, H_2SO_4 .

6. ANHYDRONE (MAGNESIUM PERCHLORATE)

Reject material passing a 10-mesh sieve.

7. ORGANIC-FREE WATER

This is an important reagent in this method. Start with a good quality distilled (not de-ionized) water and distill it once again in an all-glass apparatus. Reflux the distillate, about one liter at a time, with 10 g of potassium persulphate $\text{K}_2\text{S}_2\text{O}_8$ and 1-2 ml of 85% phosphoric acid for 4 hr and then distill it into a receiver, protected from dust, rejecting the first 100 and last 200 milliliters. Store in a clean glass-stoppered bottle, which is never left open. This water, when analyzed as described below, should not contain more than 0.2 mg C/liter.

8. PHOSPHORIC ACID 3% v/v

Dilute 30 ml analytical reagent grade 85% (syrupy) phosphoric acid, H_3PO_4 , to 1000 ml with organic-free water in a glass-stoppered glass bottle. Add 10 g of potassium persulphate, $\text{K}_2\text{S}_2\text{O}_8$, and heat the bottle (with the stopper loosened) for 4 hr in a boiling water bath. Cool and store in the same stoppered glass bottle. This solution is stable indefinitely.

9. POTASSIUM PERSULPHATE

Add solid, analytical reagent grade potassium persulphate, $\text{K}_2\text{S}_2\text{O}_8$, to 500 ml of organic-free water at 70 C until no more solid dissolves (ca. 120 g). Keep the solution in a well-covered beaker for 2 hr, cool to room temperature, and filter the crystals onto the clean sintered-glass filter base of a Millipore filtration unit with no filter paper in place. Remove the crystals with a metal spatula into a clean glass dish and dry them in a dust-free atmosphere at 50 C for 12-24 hr. Pulverize the crystals to a fine powder in a clean glass mortar. Store in glass with a glass cover which is never left off unnecessarily.

F. EXPERIMENTAL

PROCEDURE

Note: The Beckman IR spectrometer and recorder should be switched on about 60 min before measuring the first sample.

1. Add 200 mg of potassium persulphate to an ampule with the special scoop and small glass funnel and then introduce, from the 10-ml hypodermic syringe, 5.0 ml sample (Note *a*). Finally, add 0.25 ml of 3% phosphoric acid using the 1.0 ml hypodermic syringe (Note *b*).

2. Place a 5- to 7-cm length of silicone tubing just over the top of the ampule and seal the open end of this tubing with a small plug of silicone grease (*ca.* 2–3 mm long). Insert the steel cannula into the side of the tubing, at about mid-length, and poke it down through the neck of the ampule into the sample.

3. Pass nitrogen through the solution for 5 min with a flow-rate of about 200 ml/min (Note *c*). Remove the cannula and press down the plug of grease to reseal the tube.

4. Immediately seal the ampule by rotating it with the top (as near as practicable to the silicone tube) in a small blunt oxyhydrogen flame from a glassblower's torch (Note *d*).

5. Autoclave ampules at 130 C in steam (24 psi) for 40 min (Note *e*).

6. Cool the ampules to room temperature (Note *f*). Place the ampule firmly into the tygon tube with the cannula sticking into the silicone tube, as shown in the diagram. Remove the ascarite guard tube at the end of the train and turn on the tap to the IR spectrometer. With about 5–10 psi at the cylinder adjust the micrometer metering valve until a flow-rate of 200 ml/min of nitrogen is obtained. Maintain this flow until the recorder reads zero (Note *g*).

7. Crush the end of the ampule through the tygon tubing, using a small pair of pliers, and quickly push the cannula down through the hole at the top of the ampule until it is well under the liquid (Note *h*). The flow rate should return to 200 ml/min after a brief rise (Notes *i* and *j*). Continue passing nitrogen until the recorder pen returns to zero. Remove the ampule after withdrawing the cannula, shake out any broken glass from the tygon tubing, and put in the next ampule. Repurge the system and break the new ampule, etc., as described above. After finishing a batch of samples remove the cannula completely, wash it with water, and replace it through the silicone tube down into a clean dry empty ampule left for this purpose. Purge the system and then turn off all taps and replace the ascarite tube at the end of the train (Note *k*).

8. Measure the peak height of the curve recorded from the infrared analyzer or, preferably, the area under this curve and calculate the amount of carbon (as mg C/liter) as described in Section H. Subtract a blank obtained as described in Section G.

NOTES

(*a*) The hypodermic syringe and needle should first be rinsed with sample. The sample and phosphoric acid syringes must not be greased. After use both syringes should be cleaned by sucking up and expelling a little distilled water.

(b) Ampules should not be left for too long between filling and sealing to minimize contamination and are best filled and sealed one at a time.

(c) Use about 5–10 psi of nitrogen. The flow meter must first be calibrated if the manufacturer's calibration is not available. Gas escaping out of the silicone grease plug hinders the re-entry of atmospheric carbon dioxide. The ampule should be resealed with the finger after the cannula is removed from the tubing.

(d) This is a critical stage in the method and some practice is necessary. The sealing should be done rapidly (a few seconds) to minimize the entry of atmospheric or combustion CO_2 . The seal should be somewhat tapered to facilitate breakage later (*see F.7, above*). The recognition of a suitable seal comes with experience.

(e) This time is not critical but should exceed 30 min after the autoclave has come to full temperature and pressure. We have found no evidence that prolonging the heating improves oxidation, indeed, the persulphate may be decomposed fairly rapidly. For this reason it is best to ensure that the ampules come to temperature as rapidly as possible. We have found no evidence that the persulphate decomposes, even after a few weeks, at room temperature but such a decomposition is possible, especially in the presence of certain metal ions, and for this reason we do not recommend that sealed ampules be stored for more than 1 or 2 days before being heated.

(f) This may be done at any convenient rate.

(g) The zero is adjusted by a small screw on one of the light paths of the analyzer. As the analyzer cells get more and more use this adjustment will have to be increased. Finally when zeroing is no longer possible the cells should be dismantled and cleaned. If peak height is measured exact zeroing is not necessary but it is required if peak area is measured (*refer to Section H*).

(h) This is another critical stage of the method which requires practice. As mentioned in Note *d*, the operation is facilitated by having the correct type of elongated seal. Check that the ampule has not cracked down to below the tygon tube. A good rapid break is essential if peak height is to be measured but this is not so critical if area is measured (*see Section H*).

(i) A constant and reproducible flow rate is essential at this stage. The rate need not be exactly 200 ml/min provided that it is reproduced for standards and samples to within a few per cent when measuring peak heights. If peak areas are used an exact reproducibility of flow rate is not so important.

(j) Be on the lookout for blockage of the cannula by rubber or for the hole in the silicone tube enlarging so much that leaks occur. Both these troubles will be detected by a drop of flow-rate at a given setting of the precision metering valve. If this occurs to a significant extent during the analysis of a sample (5% or more) the determination should be rejected. The silicone tube requires renewing frequently (about every 20–50 samples).

(k) It is necessary to change the potassium iodide solution (which absorbs the chlorine produced by the action of persulphate on sea water) every 20–30 samples. The anhydrous should be changed every day. Other desiccants have been found to absorb carbon dioxide.

G. DETERMINATION OF BLANKS

Note: All glassware, filters, reagent bottles, pipettes, etc. must be cleaned with hot chromic-sulphuric acid, rinsed with distilled water, and finally rinsed with organic-free water. The ampules are first rinsed with distilled water, shaken nearly dry, and then ignited for 4 hr in a muffle furnace at 450–500 C. Any aluminum foil that may contact samples should first be ignited for a few hours at about 500 C.

A reagent blank is difficult to determine for this method because of the impossibility of getting water completely carbon-free. Carry out the method exactly as described in Section F, paragraphs 1–8, except make duplicate determinations on 1.0 ml, 2.5 ml, and 5.0 ml of low carbon sea water (e.g. a sample taken below 500 m). Convert mean peak heights or areas to mg C/liter from the calibration curve

(Sect. H) and plot these carbon concentrations as a function of the number of milliliters of sample. Extrapolate to determine the value at zero volume. This quantity should be equivalent to between 0.15 and 0.3 mg C/liter and must be redetermined every time new phosphoric acid or persulphate is used.

H. CALIBRATION

1. STANDARD GLUCOSE SOLUTION

Dissolve 1.25 g of dry glucose in 250 ml of distilled water. Add a few crystals of mercuric chloride, HgCl_2 , and keep this stock solution in the refrigerator.

Dilute 5.0 ml of this solution to 100 ml with organic-free water. If refrigerated, this solution may be left in glass for a few days. Finally dilute 5.0 ml of this latter solution to 100 ml with organic-free water and use this working standard immediately.

1 ml \equiv 1 mg C/liter when diluted to 5 ml

Two sensitivity settings should be found for the infrared analyzer by trial and error such that nearly full scale deflection (10 mv) is obtained for peaks corresponding to 2.0 ml of the above standard (made to 5.0 ml with organic-free water) and to 6.0 ml of the above standard (no water addition). The first setting will be most commonly used. If more than about 6 mg C/liter is determined the calibration curve may deviate from linearity to a serious extent.

Prepare standards, in duplicate, containing either 0.5, 1.0, and 2.0 ml of standard solution or 2.0, 4.0, and 6.0 ml of standard solution, according to whether or not the carbon in samples is expected to lie above or below 2 mg C/liter. Add sufficient organic-free water (the same as used to make the standard solution) to make the volume to 5.0 ml (except when using the 6.0 ml of standard) and carry out the determination exactly as described in Section F, paragraphs 1-7. Measure either peak heights or, preferably, for a variety of reasons discussed in the Notes to Section F, measure areas under the peaks obtained from all standards. Plot these heights or areas against the concentration of organic carbon which would have been present in 5.0 ml of water in the ampules — 0.5, 1.0, and 2.0 mg/liter or 2.0, 4.0, and 6.0 mg C/liter. The calibration curve for the lower concentrations should be linear and that for the higher concentrations slightly curvilinear. In both cases an extrapolation to zero added carbon gives a blank height or area for reagents plus organic-free water which should not exceed the equivalent of 0.5 mg C/liter. This value is then subtracted from all peak-height or area values which are then replotted to give curves going through the origin. These become the working standardization curves used to convert peak-heights or areas from samples and blanks to mg C/liter. It is difficult to specify how often a calibration curve should be determined but this should be done at least daily with every batch of samples. For the most precise work, or if the apparatus is suspect, it is best to make a calibration at the beginning, middle, and end of each day's work. If the total spread at the higher carbon additions does not exceed 15%, take the mean of all values for the day. If the curves differ significantly use the most appropriate curve for each sample, according to the time of day of the determination.

III.5. DETERMINATION OF CYANOCOBALAMIN (VITAMIN B₁₂)

INTRODUCTION

The following method, using a B₁₂-requiring diatom and measuring the rate of radioactive carbonate uptake of cells exposed to different concentrations of the vitamin, is probably the most sensitive and rapid procedure yet available. It is derived from an initial radiocarbon uptake technique by Gold as modified by Carlucci and Silbernagel (*Canadian J. Microbiol.*, 12: 175, 1966).

METHOD

A. CAPABILITIES

Range: 0.05–3 m μ g B₁₂/liter (greater quantities after initial dilution)

1. PRECISION AT THE 1.5 M μ G B₁₂/LITER LEVEL

The correct value lies in the range:

$$\text{Mean of } n \text{ determinations } \pm 0.5/n^{\frac{1}{2}} \text{ m}\mu\text{gB}_{12}/\text{liter.}$$

2. PRECISION AT THE 0.2 M μ G B₁₂/LITER LEVEL

The correct value lies in the range:

$$\text{Mean of } n \text{ determinations } \pm 0.02/n^{\frac{1}{2}} \text{ m}\mu\text{gB}_{12}/\text{liter.}$$

Note: The precision of this method depends largely on the presence or absence of inhibitors in the seawater sample being analyzed. The above precision indicates about the worst to be expected with moderate inhibition. For seawater samples having no inhibitory properties the precision would be considerably improved.

B. OUTLINE OF METHOD

Seawater samples are filter-sterilized, supplemented with sterile constituents and, if necessary, diluted with a similar nutrient-supplemented vitamin-free sea water. The solutions are inoculated with B₁₂-starved cells of the diatom *Cyclotella nana* and allowed to incubate for 46 hr. Carbon-14 labelled sodium carbonate is then added and the uptake of labelled carbon measured over a 2-hr exposure to constant light in a suitable incubator. Rates of carbon-14 uptake are proportional to B₁₂ concentrations over certain ranges of vitamin concentration after suitable precautions are taken, by means of internal standardization, to allow for inhibitors in the water. *Cyclotella nana* responds to a number of analogues and thus the concentration measured by this method reflects the presence not only of vitamin B₁₂ proper but of many of its analogues.

C. SPECIAL APPARATUS AND EQUIPMENT

50-ml micro-Fernbach flasks with deLong necks to accommodate stainless steel Morton enclosures.

125-ml Erlenmeyer flasks closed with cotton wool plugs enclosed in cheesecloth.

10-, 5-, 1-, and 0.1-ml graduated pipettes for the preparation of media.

Note: All glassware should be washed with detergent, treated with chromic-sulphuric acid for 12–24 hr, rinsed thoroughly with de-ionized water, and baked for 1 hr at about 400 C (an electric "hot plate" on high).

An illuminated incubator with a temperature controlled at 22 ± 2 C. Lights should be cool-white fluorescent and preferably placed below the bioassay vessels. The light field should be as uniform as possible with an intensity of about $0.05 \text{ cal cm}^{-2} \text{ min}^{-1}$ (15,000 lux).

D. SAMPLING PROCEDURE AND SAMPLE STORAGE

Samples should be filtered as soon as possible after collection. Filter under aseptic conditions if possible. Store the filtered samples in clean polypropylene bottles frozen at -20 C in a deep-freezer.

E. SPECIAL REAGENTS

1. VITAMIN-FREE WATER

For each bioassay of approximately 40 determinations (including external and internal standards) 500 ml of vitamin-free water are required. Prepare at least 1 liter at a time using natural sea water with a salinity within about 5% of the salinity of the samples to be analyzed. Use 10 g of Norite-A (decolorizing carbon) for every liter of sea water. Pretreat the Norite by shaking it for 10 min with 500 ml of 5% w/v solution of analytical reagent quality sodium chloride in distilled water. Filter the suspension through a Whatman No. 1 or equivalent filter. Transfer the charcoal to a fresh sodium chloride solution and repeat the above operation twice more. Add the washed charcoal to 1 liter of the natural sea water and shake for 0.5 hr. Filter the sea water through a Whatman No. 2 paper and then aseptically through a PH Millipore filter. Store aseptically.

2. NUTRIENT SOLUTIONS

(a) *Chelated metals, nitrate, and phosphate.* Dissolve 0.08 g cobalt chloride, $\text{CoCl}_2 \cdot 6\text{H}_2\text{O}$, and 0.08 g copper sulphate pentahydrate, $\text{CuSO}_4 \cdot 5\text{H}_2\text{O}$, in 100 ml of distilled water. Add 1.0 ml of this solution to approximately 800 ml of a solution containing 0.2 g ferric chloride, $\text{FeCl}_3 \cdot 6\text{H}_2\text{O}$; 0.06 g zinc sulphate, $\text{ZnSO}_4 \cdot 7\text{H}_2\text{O}$; 0.12 g manganous sulphate, $\text{MnSO}_4 \cdot \text{H}_2\text{O}$; and 0.03 g sodium molybdate, $\text{Na}_2\text{MoO}_4 \cdot 2\text{H}_2\text{O}$. Add 1.2 g of disodium ethylenediaminetetraacetate and dilute to about 900 ml with distilled water. Adjust the pH of the solution with dilute sodium hydroxide until it is just over 7.5. Avoid any permanent precipitate formation which may arise from the addition of too much alkali. Add 10 g potassium nitrate, KNO_3 , and 1.4 g potassium dihydrogen phosphate, KH_2PO_4 . Dilute the solution to 1 liter and autoclave it at least 15 psi for 15 min. Store the solution in a glass bottle in the dark.

(b) *Sodium silicate.* Dissolve 10.5 g of sodium metasilicate pentahydrate, $\text{Na}_2\text{SiO}_3 \cdot 5\text{H}_2\text{O}$, or 14.0 g $\text{Na}_2\text{SiO}_3 \cdot 9\text{H}_2\text{O}$, in 1 liter of distilled water. Sterilize the solution by filtering it through a fritted-glass filter, UF grade, and store it in a sterilized polypropylene container.

(c) *Hydrochloric acid.* Prepare 0.1 N HCl and determine by titration the amount of this solution necessary to neutralize 10 ml of solution 2b. If x ml is this volume, dilute $100x$ ml of 0.1 N HCl to 1 liter with distilled water. Sterilize the acid solution by filtering it through a fritted-glass filter, UF grade, and store in a sterilized polypropylene bottle.

(d) *Vitamin solution.* Dissolve 10 mg of thiamine hydrochloride and 10 mg of biotin in 100 ml of distilled water. Dilute 10 ml of this solution to 100 ml. Sterilize the diluted vitamin solution by passing it through a fritted-glass, UF grade, filter. Store in 10-ml portions in sterile screw-capped test tubes at -20 C.

3. RADIOACTIVE CARBONATE

Prepare sealed sterile glass ampules containing radioactive sodium carbonate and sodium chloride mixture with activities of 1 μ c per ampule as described in Section V.3,E.5. The activity of the radiocarbonate solution does not need to be known precisely.

4. ALGAL INOCULUM (B₁₂-FREE)

To each of three sterile 125-ml Erlenmeyer flasks add 50 ml of B₁₂-free sea water and plug the flask with a sterile cotton plug enclosed in cheese cloth. Add to each flask 0.25 ml of nutrient solution 2a, 0.3 ml of solution 2b, 0.3 ml of solution 2c, and 0.05 ml of solution 2d. To one flask add 0.05 ml of B₁₂ solution prepared as described later in Section G. This last flask contains a complete medium and is used to maintain algal stocks. Transfer 0.5 ml of an *actively growing* culture of *Cyclotella nana* to this flask. Clone 13-1 obtainable from Woods Hole Oceanographic Institution is suitable. The culture should be visibly turbid with cells. Incubate the transfer at 22 C in the light incubator for 3 days. Transfer 0.5 ml to one of the remaining two flasks which contains the vitamin B₁₂-free medium. Incubate this transfer for a further 3-4 days. Add 0.5 ml of this second culture to the remaining flask containing the B₁₂-free medium. After 3 days incubation the culture is in a log phase of growth, almost entirely stripped of vitamin B₁₂ and is ready to be used as an inoculum.

The preparation of this inoculum is critical and the times of incubation given above should be adhered to closely. Some trial experience may be necessary to obtain a final suitable inoculum which must contain between about 0.5 and 2×10^6 cells/ml, with no excess vitamin B₁₂ and with the cells still physiologically active.

F. EXPERIMENTAL

PROCEDURE

1. Thaw the samples (Note a) and add duplicate aliquots of between 5 and 20 ml (Note b) aseptically to 50-ml micro-Fernbach flasks. Where necessary, bring the volume in each flask to 20 ml by the aseptic addition of B₁₂-free sea water.

2. Add to each flask 0.1 ml of nutrient solution a, 0.12 ml of nutrient solution b, 0.12 ml of nutrient solution c, and 0.02 ml of nutrient solution d (Note c). To one of each duplicate make a 1.0 μ g/liter addition of vitamin B₁₂ to serve as an internal standard as described in Section G below (Note d).

3. To each bioassay flask add 0.2 ml of the inoculum of *Cyclotella nana* prepared as described in E above. The concentration of cells in the inoculum should be approximately 10^8 cells/ml so that the initial concentration of cells in each bioassay flask should be about 10^4 cells/ml. Should the inoculum cell concentration be notably lower or higher than 10^6 cells/ml add volumes proportionally greater or less than 0.2 ml to each flask. The addition should have a volume in the range 0.1-0.5 ml.

4. Allow all flasks to incubate in the light-incubator at 22 C for at least 46 hr and not more than 50 hr.

5. Add 1.0 ml of ^{14}C -labelled bicarbonate solution, containing 1 μc of activity to each flask, mix the solution well and replace the flask in the incubator for *exactly* 2 hr (Note *e*).

6. Filter the contents of each flask through a 25-mm diam HA Millipore filter, washing the sides of the flask with a policeman to detach any cells and rinsing with filtered sea water. Continue the determination as described in method V.3, counting the activity with a suitable gas-flow geiger counter.

7. Read the apparent concentration of vitamin B_{12} from the radioactive count obtained from each sample and a calibration curve determined with each batch of samples as described in Section G below. Let this concentration be A $\text{m}\mu\text{g B}_{12}/\text{liter}$. Read the apparent concentration of vitamin B_{12} in the flask containing sample plus internal standard which was taken through the analysis with each sample. Let this concentration be B $\text{m}\mu\text{g B}_{12}/\text{liter}$. Calculate the concentration of vitamin B_{12} in the sample from the expression:

$$\text{m}\mu\text{g B}_{12}/\text{liter} = \frac{A}{B - A} \times \frac{20}{v}$$

where v is the number of ml of sample originally taken for the analysis. If $B - A$ is less than 0.65 $\text{m}\mu\text{g B}_{12}/\text{liter}$ repeat the assay using a smaller sample volume and B_{12} -free sea water for the rest (Note *d*).

NOTES

(a) The samples should be sterile. This can be achieved if solutions are filtered at the time of collection aseptically through PH Millipore filters. Otherwise solutions obtained as described in Section D above should be sterilized by refiltering immediately prior to the bioassay.

(b) It is necessary to dilute the sample if its B_{12} content is greater than about 3.0 $\text{m}\mu\text{g B}_{12}/\text{liter}$ or if it has greater than 35% inhibition as determined by the recovery of internal standards (see Note *d* below).

(c) To avoid adding nutrients in large numbers of very small aliquots suitable proportions of the various nutrients may be mixed together just prior to use and used to supplement vitamin B_{12} -free sea water used for dilution. In all cases the samples and standards should have a final concentration of nutrients the same as would be obtained by adding the various volumes indicated in F.2 above, i.e., add 0.36 ml of the mixture.

(d) Internal standardization is very important as the amount of inhibition brought about by unknown substances in natural sea waters may be quite considerable. If the inhibition exceeds about 25–35%, calculations shown by F.7 above become unreliable and the determination should be repeated after further sample dilution to reduce the degree of inhibition.

(e) This time is critical and should be controlled to within 5 min.

G. CALIBRATION

1. STANDARD COBALAMINE (VITAMIN B_{12}) SOLUTION

Dissolve 11.0 mg pure crystalline vitamin B_{12} in 100 ml of distilled water. (Use 11 mg of vitamin instead of 10 mg to allow for the presence of about 10% of water of crystallization.) Sterilize the solution by passing it through a fritted-glass filter, UF grade, and store it in 10-ml portions in sterile screw-capped test tubes frozen at -20 C.

2. DILUTE VITAMIN B₁₂ STANDARD SOLUTIONS

Dilute 1.0 ml of the concentrated standard solution prepared above to 100 ml with distilled water, dilute 1.0 ml of this solution to 100 ml with water, and finally dilute 1.0 ml of the second dilution to 10 ml with water.

$$1 \text{ ml} \approx 1.0 \text{ m}\mu\text{g B}_{12}$$

This solution will be referred to as solution *A*. Make further dilutions using B₁₂-free sea water as follows:

- 6 ml of solution *A* to 10 ml (solution *B*)
- 4 ml of *A* to 10 ml (solution *C*)
- 2 ml of *A* to 10 ml (solution *D*)
- 8 ml of *D* to 10 ml (solution *E*)
- 4 ml of *D* to 10 ml (solution *F*)
- 2 ml of *D* to 10 ml (solution *G*)
- 1 ml of *D* to 10 ml (solution *H*)

3. PROCEDURE

Add to one of each duplicate sample (Section F.2 *above*) 0.1 ml of solution *D*. This addition is equivalent to 1.0 m μ g B₁₂/liter. The sample with internal standard is analyzed with the sample containing no added standard and used for the calculation given in Section F.7.

With each *series* of samples being bioassayed put aside 8 flasks containing 20 ml of B₁₂-free enriched sea water and add to each of seven flasks 0.1 ml of solutions *B*–*H*, respectively. To one flask make no addition. The concentrations of added vitamin B₁₂ in the water in the standard series thus obtained will be 3.0, 2.0, 1.0, 0.8, 0.4, 0.2, 0.1, and 0 m μ g B₁₂/liter, respectively. Incubate these standards with the samples and continue as described in Section F.3–6 *above*. Prepare a calibration curve by plotting the final counts/min of each standard against the concentration of added vitamin B₁₂.

Note: Although the method presented here uses ¹⁴C incorporation by cells of the test alga to measure vitamin response, vitamin B₁₂ concentrations can be determined by cell counts if the test cultures are allowed to incubate for 2–3 more days. This may be more practical if adequate facilities for ¹⁴C work are not available. If cell counts are used, the B₁₂ concentration in a seawater sample is calculated from an expression analogous to that given in Section F.7.



III.6. DETERMINATION OF BIOTIN

INTRODUCTION

The following method uses a biotin-requiring dinoflagellate and measures response to various concentrations of the vitamin by rate of radiocarbon uptake. The method has been described by Carlucci and Silbernagel (*Canadian J. Microbiol.*, 13: 975, 1967).

METHOD

A. CAPABILITIES

Range: 0.5–4 m μ g biotin/liter (greater quantities after dilution)

1. PRECISION AT THE 3M μ G BIOTIN/LITER LEVEL

The correct value lies in the range:

Mean of n determinations $\pm 0.28/n^{\frac{1}{2}}$ m μ g biotin/liter.

2. PRECISION AT THE 1 M μ G BIOTIN/LITER LEVEL

The correct value lies in the range:

Mean of n determinations $\pm 0.09/n^{\frac{1}{2}}$ m μ g biotin/liter.

(The precision of the method depends largely on the presence or absence of inhibitors in the seawater sample. The above precision is the worst to be expected with moderate inhibition. In samples where there are no inhibitory properties, the precision is greatly improved.)

B. OUTLINE OF METHOD

Seawater samples are filter-sterilized, and, if necessary, diluted with vitamin-free sea water. The sea water is supplemented with sterile nutrients, inoculated with biotin-starved cells of the dinoflagellate, *Amphidinium carteri*, and allowed to incubate for 94 hr in a constant-light incubator. Carbon-14 labelled sodium carbonate is then added and the uptake of labelled carbon measured over a 2-hr exposure. Rates of carbon-14 uptake are proportional to biotin concentrations over certain ranges. Internal standardization is used to account for seawater inhibition to alga growth.

C. SPECIAL APPARATUS AND EQUIPMENT

See III.5,C.

D. SAMPLING PROCEDURE AND SAMPLE STORAGE

See III.5,D.

E. SPECIAL REAGENTS

1. VITAMIN-FREE WATER

See III.5,E.1.

2. NUTRIENT SOLUTIONS

(a) *Chelated metals, nitrate and phosphate.* See III.5,E.2a.

(b) *Vitamin solution.* Dissolve 11 mg crystalline B₁₂ and 10 mg thiamine hydrochloride in 100 ml of distilled water. Dilute 10 ml of this solution to 100 ml. Sterilize the diluted vitamin solution by passage through a fritted-glass, UF grade filter. Store in 10-ml portions in test tubes at -20 C in a deep-freezer.

3. RADIOACTIVE CARBONATE

See III.5,E.3.

4. ALGA INOCULUM (BIOTIN-FREE)

To each of three sterile 125-ml Erlenmeyer flasks add 50 ml vitamin-free sea water. Plug the flask with a sterile cotton plug enclosed in cheesecloth. To each flask add 0.25 ml of nutrient solution 2a, and 0.05 ml of solution 2b. To one flask add 0.05 ml of biotin solution as described later in Section G. This flask contains the complete medium. Transfer 1 ml of an actively growing culture of *Amphidinium carteri* (culture should be visibly turbid with cells) to this flask. Incubate the transfer in the light incubator at 22 C for $6\pm\frac{1}{2}$ days, then transfer 0.5 ml of the resulting culture to one of the remaining two flasks containing biotin-free medium. Incubate this culture again for 1 week and then add 5.5 ml of this second transfer to the remaining flask of biotin-free medium. After 6 days further growth, the cells will be in the log phase of growth, stripped of biotin, and ready to be used as an inoculum.

The correct preparation of this inoculum is essential, and the times of incubation given should be adhered to closely. Some trial experiments may be necessary to obtain a final inoculum which must contain approximately 5.0×10^5 cells/ml, with no excess biotin and the cells still physiologically active.

F. EXPERIMENTAL

PROCEDURE

1. Thaw the samples (Note a) and add duplicate aliquots of between 5 and 20 ml (Note b) aseptically to 50-ml micro-Fernbach flasks. Where necessary, bring the volume in each flask to 20 ml by the aseptic addition of vitamin-free sea water.

2. Add to each flask 0.1 ml of nutrient solution 2a, and 0.02 ml of nutrient solution 2b (Note c). To one of each duplicate add a 1.0 m μ g/liter addition of biotin to serve as an internal standard as described in Section G below (Note d).

3. To each bioassay flask add 0.5 ml of the inoculum of *Amphidinium carteri* prepared as described in Section E. The concentration of cells in the inoculum should be approximately 5.0×10^5 cells/ml; thus, the initial concentration of cells in each bioassay flask is about 10^4 cells/ml. Should the inoculum cell concentration be notably lower or higher than this, add volumes proportionally greater or less than 0.5 ml to each flask. The addition should have a volume in the range 0.3-0.7 ml.

4. Allow all flasks to incubate in the light incubator at 22 C for at least 94 hr and not more than 100 hr.

5. Add 1.0 ml ¹⁴C-labelled bicarbonate solution, containing 1 μ c of activity,

to each flask, at 2-min intervals, mix the contents well, and replace the flask in the incubator for exactly 2 more hr (Note *e*).

6. Filter the contents of each flask through a 25-mm diam HA Millipore filter, washing the sides of the flask with a policeman to detach any cells and rinsing with filtered sea water. Continue the determination as described in the method for photosynthetic rates, Section V.3, counting the activity with a suitable gas-flow geiger counter.

7. Read the apparent concentration of biotin from the radioactive count obtained from each sample from a calibration curve prepared with each batch of samples as described in Section G below. Let this concentration be A m μ g biotin/liter. Read the apparent concentration of biotin in the flask (containing sample plus internal standard) which was taken through the analysis with each sample. Let this concentration be B m μ g biotin/liter. Calculate the concentration of biotin in the sample from the expression:

$$\text{m}\mu\text{g biotin/liter} = A \times \frac{1}{B - A} \times \frac{20}{v}$$

where v is the number of ml of sample originally taken for the analysis. If $B - A$ is less than 0.65 m μ g biotin/liter repeat the assay using a smaller sample volume (Note *d*).

NOTES

(*a*) The sample should be sterile. This can be achieved if solutions are filtered at the time of collection aseptically through PH Millipore filters. Otherwise solutions obtained as described in Section D above should be sterilized by refiltering immediately prior to the bioassay.

(*b*) It is necessary to dilute the sample if its biotin content is greater than 4 m μ g biotin/liter or if it has greater than 35% inhibition as determined by the recovery of internal standards (see Note *d* below).

(*c*) To avoid adding nutrients by separate aliquots, suitable proportions of the nutrients may be mixed together just prior to use and supplementation can be made with one aliquot. The final concentration of nutrients in all flasks should be the same as obtained by adding the volumes separately as indicated in F.2 above, i.e., 0.12 ml of the mixture.

(*d*) Internal standardization is important because unknown substances in natural sea waters can cause considerable inhibition to the growth of the alga. If the inhibition exceeds about 25–35%, calculations presented in E.7 above become unreliable, warranting a repeat determination with a greater dilution of the sample with vitamin-free sea water.

(*e*) This time is critical and should be controlled to within 5 min.

G. CALIBRATION

1. STANDARD BIOTIN SOLUTION

Dissolve 10.0 mg of pure crystalline biotin in 100 ml of distilled water. Sterilize the solution by passing it through a fritted-glass filter, UF grade, and store in 10-ml portions at -20 C.

2. DILUTION OF BIOTIN SOLUTION

Dilute 1.0 ml of the concentrated standard solution prepared above to 100 ml with distilled water; dilute 1.0 ml of this solution to 100 ml; dilute 5.0 ml of this second dilution to 25 ml with distilled water.

$$1 \text{ ml} \equiv 2.0 \text{ m}\mu\text{g}$$

This solution is to be referred to as solution *A*. Make further dilution using vitamin-free water as follows:

- 5 ml of solution *A* to 10 ml (solution *B*)
- 4 ml of solution *A* to 10 ml (solution *C*)
- 3 ml of solution *A* to 10 ml (solution *D*)
- 2 ml of solution *A* to 10 ml (solution *E*)
- 1 ml of solution *A* to 10 ml (solution *F*)
- 0.5 ml of solution *A* to 10 ml (solution *G*)

3. PROCEDURE

Add to one of each duplicate sample (Section F.2 *above*) 0.1 ml of solution *F*. This addition is equivalent to 1.0 m μ g biotin/liter. The sample with the internal standard is analyzed with the duplicate containing no added biotin and used for the calculation described in Section F.7.

With each *series* of samples being bioassayed prepare 7 flasks containing 20 ml of vitamin-free sea water enriched with the nutrient solutions as described in F.2. To one flask make no addition and to the other six flasks add 0.1 ml of solution B–G, respectively. The concentrations of added biotin in the sea water of the external series will be 5, 4, 3, 2, 1, and 0.5 m μ g biotin/liter, respectively. Inoculate and incubate these standards as described in Section F.3–6 along with the samples being bioassayed. Prepare a calibration curve by plotting the counts/min against the concentration of biotin in that standard. The biotin concentrations in the samples and the internals are read from the calibration curve.

Note: Cell counts rather than radioactivity may be used to measure vitamin concentrations. See note in III.5.G.

III.7. DETERMINATION OF THIAMIN (VITAMIN B₁)

INTRODUCTION

The following method uses a thiamin-requiring chryomonad as assay organism and measures the response to various concentrations of the vitamin by rate of radiocarbon uptake. The method has been described by Carlucci and Silbernagel (*Canadian J. Microbiol.*, 12: 1079, 1966).

METHOD

A. CAPABILITIES

Range: 2–35 mμg B₁/liter (greater quantities after initial dilution)

1. PRECISION AT THE 20 MμG B₁/LITER LEVEL

The correct value lies in the range:

Mean of n determinations $\pm 1.3/n^{\frac{1}{2}}$ mμgB₁/liter.

2. PRECISION AT THE 5 MμG B₁/LITER LEVEL

The correct value lies in the range:

Mean of n determinations $\pm 1.0/n^{\frac{1}{2}}$ mμgB₁/liter.

(The precision of the method depends largely on the presence or absence of inhibitors to the algae in the sample. Precision increases if the level of seawater toxicity decreases.)

B. OUTLINE OF METHOD

Seawater samples are filter-sterilized and, if necessary, diluted with a vitamin-free sea water. The dispensed sea water is then supplemented with nutrients. The solutions are inoculated with B₁-starved cells of *Monochrysis lutheri* and incubated for 46 hr. Carbon-14 labelled sodium carbonate is then added and the uptake of labelled carbon by the cells measured over a 2-hr exposure in a constant-light incubator. Rates of carbon-14 uptake are proportional to B₁ concentrations over certain ranges. Internal standardization is used to account for inhibitors present in the sea water.

C. SPECIAL APPARATUS AND EQUIPMENT

See III.5,C.

D. SAMPLING PROCEDURE AND SAMPLE STORAGE

See III.5,D.

E. SPECIAL REAGENTS

1. VITAMIN-FREE WATER

See III.5,E.1.

2. NUTRIENT SOLUTIONS

See III.5,E.2a.

(b) *Vitamin solution.* Dissolve 11 mg crystalline B₁₂ and 10 mg of biotin in 100 ml of distilled water. Dilute 10 ml of this solution to 100 ml. Sterilize the diluted vitamin solution by passage through a fritted-glass, UF grade filter. Store in 10-ml portions in test tubes at -20 C in a deep-freezer.

3. RADIOACTIVE CARBONATE

See III.5,E.3.

4. ALGAL INOCULUM (B₁-FREE)

To each of two sterile 125-ml Erlenmeyer flasks add 50 ml vitamin-free sea water and plug the flask with a sterile cotton plug enclosed in cheesecloth. Add to each flask 0.25 ml of nutrient solution *a*, and 0.05 ml of solution *b*. To one flask add 0.05 ml of B₁ solution prepared as described later in Section G. This flask contains a complete medium that is used to maintain algal stocks. Transfer 5.5 ml of an *actively growing* culture of *Monochrysis lutheri* (culture should be visibly turbid with cells) to this flask. Incubate the transfer at 22 C in the light incubator for 2 days, then transfer 0.5 ml of this culture to the remaining flask which contains B₁-free medium. After 5 days incubation, the culture in this flask is in the log phase of growth, almost stripped of B₁ and is ready to be used as an inoculum.

The preparation of this inoculum is critical and the times of incubation given should be adhered to closely. Some trial experiments may be necessary to obtain a final suitable inoculum which must contain approximately 5.0×10^5 cells/ml, with no excess vitamin B₁ and with the cells still physiologically active.

F. EXPERIMENTAL

PROCEDURE

1. Thaw the samples (Note *a*) and add duplicate aliquots of between 5 and 20 ml (Note *b*) aseptically to 50-ml micro-Fernbach flasks. Where necessary, bring the volume in each flask to 20 ml by the aseptic addition of vitamin-free sea water.

2. Add to each flask 0.1 ml of nutrient solution *a*, and 0.02 ml of nutrient solution *b* (Note *c*). To one of each duplicate add a 10 m μ g/liter addition of vitamin B₁ to serve as an internal standard as described in Section G below (Note *d*).

3. To each bioassay flask add 0.2 ml of the inoculum of *Monochrysis lutheri* prepared as described in Section E above, making the initial concentration of cells in each bioassay flask about 10^4 cells/ml. Should the inoculum cell concentration be notably lower or higher than 5×10^5 cells/ml add to each flask volumes proportionally greater or less than 0.5 ml. The addition should have a volume in the range 0.3-0.7 ml.

4. Allow all flasks to incubate in the light incubator at 22 C for at least 46 hr and not more than 50 hr.

5. Add 1.0 ml of ¹⁴C-labelled bicarbonate solution, containing 1 μ c of activity, at 2 min intervals, to each flask; mix the contents well and replace the flask in the incubator for exactly 2 more hr (Note *e*).

6. Filter the contents of each flask through a 25-mm diameter HA Millipore filter, wash the sides of the flask with a policeman to detach any cells, and rinse with

filtered sea water. Continue the determination as described in the method for photosynthetic rates, Section V.3, counting the activity with a suitable gas-flow geiger counter. Arrange the times for the addition of radioactive carbonate and filtration so that each sample receives exactly 2 hr (± 5 min) incubation with the isotope.

7. Using the radioactive count obtained from each sample, read the apparent concentration of vitamin B₁ from a calibration curve prepared with each batch of samples as described in Section G below. Let this concentration be A m μ g B₁/liter. Read the apparent concentration of vitamin B₁ in the flask (containing sample plus internal standard) which was taken through the analysis with each sample. Let this concentration be B m μ g B₁/liter. Calculate the concentration of vitamin B₁ in the sample from the expression:

$$\text{m}\mu\text{g B}_1/\text{liter} = A \times \frac{200}{B - A} \times \frac{1}{v}$$

where v is the number of ml of sample originally taken for the analysis. If $B - A$ is less than 6.5 repeat the assay using a smaller sample (Note *d*).

NOTES

(a) The samples should be sterile. This can be achieved if solutions are filtered at the time of collection aseptically through PH Millipore filters. Otherwise solutions obtained as described in Section D above should be sterilized by refiltering immediately prior to the bioassay.

(b) It is necessary to dilute the sample if its B₁ content is greater than about 25 m μ g B₁/liter or if it has greater than 35% inhibition as determined by the recovery of internal standards (see Note *d* below).

(c) To avoid adding nutrients by separate aliquots, suitable proportions of the various nutrients may be mixed together just prior to use and supplementation can be made with one aliquot. The final concentration of nutrients in all flasks should be the same as obtained by adding the volumes separately as indicated in F.2 above, i.e., add 0.12 ml of the mixture.

(d) Internal standardization is important because unknown substances in natural sea waters can cause considerable inhibition to the growth of the alga. If inhibition exceeds 25–35%, the calculation described in F.7 becomes unreliable, warranting a repeat determination with a greater dilution of the sample with the vitamin-free sea water.

(e) This time is critical and should be controlled to within 5 min.

G. CALIBRATION

1. STANDARD THIAMINE (VITAMIN B₁) SOLUTION

Dry thiamine hydrochloride for 4 hr at 100 C. Dissolve 10.0 mg of the dried thiamine hydrochloride in 100 ml of distilled water. Sterilize the solution by passing it through a fritted-glass filter, UF grade and store in 10-ml portions at -20 C.

2. DILUTION OF B₁ SOLUTION

Dilute 1.0 ml of the concentrated standard B₁ solution prepared above to 100 ml with distilled water; dilute 1.0 ml of this solution to 100 ml.

$$1 \text{ ml} \equiv 10.0 \text{ m}\mu\text{g}$$

This solution will be referred to as solution *A*. Make further dilutions using vitamin-free sea water as follows:

- 7 ml of solution *A* to 10 ml (solution *B*)
- 5 ml of solution *A* to 10 ml (solution *C*)

- 4 ml of solution *A* to 10 ml (solution *D*)
- 3 ml of solution *A* to 10 ml (solution *E*)
- 2 ml of solution *A* to 10 ml (solution *F*)
- 1 ml of solution *A* to 10 ml (solution *G*)

3. PROCEDURE

Add to one of each duplicate sample (Section F.2 *above*) 0.1 ml of solution *F*. This addition is equivalent to 10.0 m μ g B₁/liter. The sample with the internal standard is analyzed with the duplicate containing no added B₁ and used for the calculation described in Section F.7.

With each *series* of samples being bioassayed prepare 7 flasks containing 20 ml of vitamin-free sea water enriched with the nutrient solutions as described in F.2. To one flask make no addition, and to the other six flasks add 0.1 ml of solution B–G, respectively. The concentrations of added B₁ in the sea water of the external standard series will be 35, 25, 20, 15, 10, and 5 m μ g B₁/liter, respectively. Inoculate and incubate these standards as described in Section F.3–6, along with the samples being bioassayed. Prepare a calibration curve by plotting the counts/min against the concentration of vitamin B₁ in that standard. The B₁ concentrations in the samples and internal standards are read from this calibration curve.

Note: Cell counts rather than radioactivity may be used to measure vitamin concentrations. See note in III.5.G.

III.8. DETERMINATION OF CARBOHYDRATE

INTRODUCTION

Three methods for the determination of dissolved carbohydrates in sea water have been investigated by Handa (*J. Oceanog. Soc. Japan*, 22: 1, 1966). The anthrone reaction (Antia and Lee, *Fish. Res. Bd. Canada*, MS Rept. No. 168, 1963) and the *N*-ethylcarbazole reaction (Zein-Eldin and May, *Anal. Chem.*, 30: 1935, 1958) were shown to have a greater specificity toward certain monosaccharides than the phenol-sulphuric acid reaction. The method given here employs the latter reaction since, ideally, any method for total carbohydrate should give the same equivalent colour with different sugars.

The method is also readily adaptable to measuring carbohydrate in particulate material. It has not been employed in Section IV.8 since for phytoplankton the principal sugar has been shown to be glucose (Parsons, Stephens, and Strickland, *J. Fish. Res. Bd. Canada*, 18: 1001, 1963), which gives the greatest colour with the anthrone reagent.

METHOD

A. CAPABILITIES

Range: 0.1–20 mg/liter

1. PRECISION AT THE 0.5 MG/LITER LEVEL

The correct value lies in the range:

Mean of n determinations $\pm 0.06/n^{1/2}$ mg/liter.

2. LIMIT OF DETECTION

The smallest amount of carbohydrate that can be detected with certainty is from 0.1 to 0.25 mg/liter, depending on the nature of the sugar (Note a).

B. OUTLINE OF METHOD

Phenol and sulphuric acid are added directly to sea water and the extinction of the resulting colour is read in a spectrophotometer using a 10-cm cell.

C. SPECIAL APPARATUS AND EQUIPMENT

125-ml Pyrex Erlenmeyer flasks.

Rapid-flow 50-ml burette.

D. SPECIAL REAGENTS

1. PHENOL REAGENT

Distill phenol twice using an all-glass distilling apparatus. Weigh out 25 g of redistilled phenol and dissolve in 500 ml of distilled water. Store in an all-glass container in the refrigerator (*ca.* 5 C).

2. SULPHURIC ACID REAGENT

Dissolve 2.5 g of hydrazine sulphate in 500 ml reagent grade concentrated sulphuric acid (sp gr 1.84).

E. EXPERIMENTAL

PROCEDURE

1. Pipette 2.0 ml of glass-fiber filtered sea water into a 125-ml Pyrex Erlenmeyer flask and add 2.0 ml of phenol reagent from a burette or automatic pipette.

2. Add 10 ml of sulphuric acid reagent from a rapid flow burette. Mix by shaking the flask during the addition of the acid (Note b).

3. Cover the flask with aluminum foil and cool by allowing to stand for 1 hr (Note c) at room temperature. Measure the extinction of the solution at 4900 Å using a fused glass 10-cm cell (Note d). Correct the resulting extinction for the blank (Sect. F) and calculate the soluble carbohydrate from the expression

$$\text{mg glucose/liter} = \text{Corrected extinction} \times F$$

NOTES

(a) The relative absorbance of 8 common monosaccharides has been found to vary from 35 to 100% on the basis of the maximum colour given by xylose. Glucose, which is employed in Section G as a standard, gives 59% of the absorbance given by xylose.

(b) The addition of the sulphuric acid reagent should be carried out in an area with good ventilation since the resulting heat in the flask causes a small amount of phenol to evaporate.

(c) The time is not critical and the colour is stable for at least 24 hr.

(d) If the extinction in a 10-cm cell is greater than 1.00, use a 1-cm cell and multiply the amount of carbohydrate obtained in Section E.3 by 10.

F. DETERMINATION OF REAGENT BLANK

With each batch of samples a blank determination should be undertaken by carrying out the method exactly as described in Section E but using 2 ml of distilled water in place of the sample. The blank extinction should be less than 0.05 on a 10-cm cell with new reagents; it should not be allowed to exceed 0.1 for sensitive determinations with older reagents.

G. CALIBRATION

1. STANDARD GLUCOSE SOLUTION

Dissolve 10.0 mg of D-glucose in 1 liter of distilled water.

$$1.00 \text{ ml} = 10 \mu\text{g glucose}$$

2. PROCEDURE

To each of three 125-ml Pyrex Erlenmeyer flasks add 2.0 ml of standard glucose solution and 2 ml of phenol reagent. Carry out the procedure as described in Section E.2 and 3. Determine the factor, F , from the expression:

$$F = \frac{10}{E_s - E_b}$$

where E_s is the mean of three standard determinations as described above, and E_b is the mean of two blank determinations as described in Section F.

The value of F should be approximately 10 and should be determined at least once with each new batch of reagents.

PART IV. DETERMINATION OF PARTICULATE MATERIALS
IV.1. INTRODUCTORY REMARKS ON DIFFERENT METHODS FOR
DETERMINING PARTICULATE MATERIALS IN AQUATIC
ENVIRONMENTS

In the following procedures we have described the use of two pieces of apparatus which have been employed by us and found to give satisfactory results for the type of studies required. In both cases, however, there are a number of alternative types of equipment which may under some circumstances be more suitable depending on the type of information required. In the case of optical equipment for determining turbidity we have described the use of a Turner fluorometer, but other apparatus such as transmissometers (Berge, *Rappt. Procès-Verbaux Reunions, Conseil Perm. Intern. Exploration Mer*, 149: 148, 1961; and Hydroproducts, OEC Model 412) are known to be highly useful pieces of apparatus. In the latter case, for example, the apparatus appears to be particularly suitable for determining the probable range of underwater visibility.

Among different types of equipment for determining the size spectrum of particulate material, we have employed the Coulter Counter® Model B. However, other types of equipment (e.g. *see* Maddux and Kanwisher, *Limnol. Oceanog.* 10 (Suppl.): R162, 1965) may eventually be more useful for *in situ* studies if they become commercially available.



IV.2. A SEPARATION OF MICROSCOPIC PARTICLES FROM SEA WATER

INTRODUCTION

As mentioned previously (NOTES ON APPARATUS) the demarcation between "particulate" and "soluble" organic matter in sea water is arbitrary and depends somewhat on the filter used. Before glass-fiber filters were readily available most of the methods for the determination of particulate matter depended on the use of a technique first described by Parsons and Strickland (*Nature*, 184: 2038, 1959) and specified in the first and second editions of *A Manual of Sea Water Analysis* (Bull. Fish. Res. Bd. Canada, No. 125, 1960, and 1965). The sea water is first passed through a membrane filter coated with a little magnesium carbonate which facilitates the subsequent removal of the filtered particles from the membrane. This technique still has some advantages over the use of glass filters for certain methods but the latter are much more convenient to use for the determination of pigments, carbon, and nitrogen. A few general instructions may be given concerning the separation of particulate matter from sea water and these will therefore be described only once. It must be remembered that the same separation technique should, ideally, be used for all determinations if strictly comparable values for such properties as particulate carbon, nitrogen, and phosphorus are required. Fortunately there is little difference in the results obtained with a Whatman GF/C glass-fiber filter and a Millipore AA membrane filter lightly coated with magnesium carbonate, but an agreement between the results obtained using various filters should not be assumed in all cases without testing. There is evidence that a certain fraction of the colloidal material in sea water, which would normally pass through a glass filter, may be adsorbed on a thick bed of magnesium carbonate or onto silver metal filters.

METHOD

A. OUTLINE OF METHOD

The seawater sample is filtered through a glass-fiber filter or a membrane filter previously treated with a little fine magnesium carbonate powder to prevent particles adhering to the surface of the membrane. If necessary the particulate matter may be rinsed off the membrane filter prior to analysis by using a jet of filtered sea water.

B. SPECIAL APPARATUS AND EQUIPMENT

One 300-ml polyethylene wash bottle.

One 30-ml Pyrex glass beaker (*See* IV.4.I,F for cleaning procedure).

The filtration gear has been discussed in the section NOTES ON APPARATUS.

It is convenient to arrange matters so that 2- to 5-liter bottles holding the samples are clamped in an inverted position in the Millipore filter funnels. Filtration can then proceed unattended.

C. SAMPLING PROCEDURE AND SAMPLE STORAGE

Methods for the adequate sampling of the euphotic zone are outside the scope of the present procedure. The final sample or subsample for analysis should be passed through nylon netting as a precaution to remove any large animals or con-

taminants (cloth fibers, etc.). The mesh size of this netting is largely a matter of preference. We generally recommend 150- μ mesh unless very large phytoplankters are known to be abundant. There is now evidence that the apparent content of particulate matter in a sample of sea water, especially as measured by organic carbon, increases the more samples are "handled," e.g., transferred from one vessel to another or agitated (especially if bubbles are produced). There is also an increase in particulate matter when samples are allowed to stand for long periods and they should be filtered without delay. We cannot stress too strongly the necessity of using clean bottles and overside sampling equipment. There is no conclusive evidence that contamination occurs from clean polyethyleneware although for the most careful work it might be best to use all-glass equipment. When it is remembered that only a few tens of micrograms of material are being determined in each liter of sample, the need to protect samples and the filter funnels from atmospheric dust becomes apparent.

D. SPECIAL REAGENTS

1. MAGNESIUM CARBONATE SUSPENSION

Add 1 g of magnesium carbonate powder to 100 ml of distilled water in a 250-ml Pyrex Erlenmeyer flask fitted with a ground-glass stopper. Shake the flask vigorously to suspend the powder immediately before use. The magnesium carbonate powder *must* be of analytical reagent quality and should be of a "light form" (Levis). The carbonate sold by the J. T. Baker Chemical Co. as $(\text{MgCO}_3)_4 \cdot \text{Mg}(\text{OH})_2 \cdot n\text{H}_2\text{O}$, with a mean particle diameter of about 10 μ , was found to be satisfactory.

2. FILTERED SEAWATER SOLUTION

Use freshly filtered water from the first sample being analyzed in each batch. Do not store.

E. EXPERIMENTAL

PROCEDURE

Note 1: The volume to use for the individual methods given later varies greatly according to the location of the sample and the time of year. The pigment content of the water is not too good a guide as detrital material may often predominate. In general, clear open-ocean samples will need to have a volume of at least 3–4 liters whereas in coastal waters during a phytoplankton bloom as little as 500 ml may suffice. The suitable volume to use depends largely upon the judgment of the analyst and will often have to be determined by trial and error. Membrane filters are clogged by a positive blocking action and there is little to be gained by prolonging filtration once it has slowed down to less than about 50 ml/min.

Note 2: If glass-fiber filters are used no further comment is necessary except to say that the filter funnel needs only a small wash with filtered sea water. The following instructions are given in detail for the filtration procedure to be used if a coated membrane filter is employed.

1. Fit a 47-mm diam AA Millipore membrane filter into the filter holder. Add about 25 ml of distilled water to the filter *without* suction and then add 2–3 ml of magnesium carbonate suspension. Agitate the suspension until it is uniform and then apply suction to remove the water.

2. With full suction still applied carefully fill the filtration unit with the sample, invert the bottle containing the rest of the sample into the filtration unit, and clamp

the bottle so that continuous filtration is possible. The bottle need not be rinsed but the contents should be shaken vigorously before filtration is commenced.

3. When the membrane filter is sucked dry release the vacuum immediately. Dismantle the filtration unit and remove the membrane with clean metal forceps. (Do *not* touch by hand).

4. Wash off the precipitate from the filter with short, hard spurts of filtered sea water from the polyethylene wash bottle. The efficacy of this procedure depends much upon the size of the wash bottle orifice and this should be adjusted by trial and error so that all the precipitate is removed by 10–12 ml of water. The membrane filter should wash quite free from stain although a very slight stain left after removing a heavy precipitate can be ignored.

The various analyses are continued as follows:

IV.5. (PHOSPHORUS): Rinse the precipitate directly into a specially cleaned 125-ml Pyrex Erlenmeyer flask using *distilled water*.

IV.7. (LIPID), IV.8. (CARBOHYDRATE), and IV.9. (CHITIN): Rinse the precipitate directly into the specially cleaned 30-ml beaker using filtered sea water and then rinse the contents of the beaker into a 15-ml graduated centrifuge tube. The total volume in the tube should not exceed 15 ml. Centrifuge down the solid and suck off the supernatant liquid with a fine capillary tube leaving only a few milliliters of solution.

F. DETERMINATION OF BLANK

Small quantities of organic material may be present in magnesium carbonate or be washed off from a Millipore filter. For surety, therefore, all the methods which follow in Part IV should be corrected by a blank determination made on the *entire procedure*. This precaution may be relaxed for certain analyses, i.e. magnesium carbonate can be placed directly into centrifuge tubes, etc., but only at the discretion of the analyst after considerable experience. Initially we recommend the following: carry out the method as described in Section E above, using 2 ml of magnesium carbonate suspension and about 50 ml of distilled water but filtering no sample. Continue exactly as in paragraphs 3 and 4 ending up with a "blank" precipitate in a suitable container, according to the method.



IV.2.I. DETERMINATION OF THE WEIGHT OF MICROSCOPIC MATERIALS IN SEA WATER

INTRODUCTION

By far the greatest fraction by weight of the particulate material in sea water is less than 300μ in greatest dimension. If a sample of sea water is first passed through netting with a mesh size about $150\text{--}350 \mu$ to remove the larger organisms the remaining material, the "micro seston," will contain both organic and inorganic material. The proportion of these components depends upon the sea area but there is generally several times more inorganic than organic matter present. An idea of the total weight of suspended micromatter may be useful in various ecological studies. This weight is often better correlated with optical properties than are either particulate carbon or chlorophyll data. The following method is taken from Banse, Falls, and Hobson (*Deep Sea Res.* 10: 639, 1963) with very little change.

METHOD

A. CAPABILITIES

There is, within reason, no maximum to the amount of suspended solids that can be determined by this procedure as the sample volume may be reduced when the particulate content of samples increase. In practice the largest amounts likely to be encountered in most truly marine environments away from excessive mud and sand will be about $10,000 \text{ mg/m}^3$.

If V liters of sample is used to give a weight of solids of several milligrams the precision should be better than

$$\pm \frac{400}{V n^2} \text{ mg/m}^3$$

where n is the number of determinations. The limit of detection by a single determination is about

$$\pm \frac{300}{V} \text{ mg/m}^3$$

The precision of the determination on samples is markedly less than would be indicated from the reproducibility of weighing clean filters.

B. OUTLINE OF METHOD

The sample is filtered through a tared glass or membrane filter which is washed free from salts, dried at 75 C , and reweighed. Special precautions are taken to allow for changes of weight due to hygroscopicity of the filters and to electrostatic charge effects during weighing.

C. SPECIAL APPARATUS AND EQUIPMENT

Flat-bladed forceps without serrated tips. Boned tipped weighing forceps are excellent.

Electrobalance with a radioactive source in the weighing chamber. Such a balance may be obtained from the Cahn Instrument Company (Gram Electrobalance) and has the advantage over more conventional semimicro- and micro-

balances that small weight differences may be obtained with greater ease and precision. It is possible to get suitable instruments from the Mettler, Sartorius, and Ainsworth Companies. It is *essential* in dry climates that the balance case contain a radioactive source (polonium or thorium) to ionize the air or serious errors, due to the development of electrostatic interactions between the filters and balance, may be obtained when using filters of non-conducting material.

A manostat device (there are several cheap commercial models based on the Cartesian diver) set to regulate the suction to the filtration unit to prevent the vacuum becoming greater than 300–350 mm of mercury.

Small plastic or metal pillboxes to store filters before and after use.

D. SAMPLING PROCEDURE AND SAMPLE STORAGE

See Procedure IV.2,C for details.

E. EXPERIMENTAL

PROCEDURE

1. Take the required number of 47-mm HA Millipore filters or ignited (500 C) glass-fiber papers and number them consecutively, near the edge, with a ball-point pen (Note *a*). Mark every tenth filter, or a minimum of two, one at the beginning and one at the end of each batch of filters to be weighed, by the letters A, B, C, etc. Soak the filters for 5 min in a small tray of distilled water (Note *b*) and then remove them one at a time onto the shiny surface of *clean* aluminum foil, having first removed the excess water by shaking (Note *c*).

2. Dry the filters on the foil for about 30 min at 75 C and then store them, in a small plastic or metal box, numbered consecutively from the top of the pile. It is recommended that determinations be carried out in batches of not more than about twenty, which is sufficient for most "stations" on an oceanographic cruise and is all that can be conveniently weighed and dried using a large laboratory desiccator.

3. Take a batch of filters from the storage box, including a minimum of two of the "lettered" filters (Note *d*) which are treated as will be described in Section F. Lay the filters on a clean piece of aluminum foil with little overlap and dry them in a hot air oven at 75 C for 1 hr (Note *e*). Remove the foil and filters to a desiccator containing dry silica gel and allow them to cool for a few minutes. Remove each filter and weigh it as rapidly as possible, recording the weight to the nearest 0.01 mg. Let this weight be W_1 mg. Close the desiccator firmly after removing each filter as dried filters are very hygroscopic. Place the tared numbered and lettered filters from each batch into a separate pillbox for storage until samples are to be filtered.

4. Place a tared filter on the base-plate of a membrane-filter apparatus with a *small* slip of aluminum foil under the margin of the disc to facilitate its removal when wet. Assemble the filter funnel and filter a suitable volume of sample (Note *f*) through the membrane using the controlled pressure device to limit suction to 15 inches of mercury (Note *g*).

5. Wash the filter and the lower end of the funnel rapidly with two rinses of distilled water, each not exceeding 2.5–5 ml in volume. Disconnect the source of vacuum between each rinse so that the water covers the filter and then rapidly

apply suction to remove the water (Note *h*). Take off the funnel top and, with suction still applied, wash the margin of the filter (which is free from precipitate but which may be wet with sea water) with drops of distilled water (Note *i*).

6. Disconnect the source of vacuum and remove the filter with great care using the flat-bladed forceps. Place it on aluminum foil and dry it, along with others of the same batch, for 1 hr at 75 C (Note *j*). Remove the filters and foil to a desiccator and retare them rapidly as described in paragraph 3. Let W_2 be the weight of a filter plus particulate matter. Calculate the dry weight of particulate material in a sample from the expression:

$$\text{dry weight of micro seston (mg/m}^3\text{)} = \frac{W_2 - W_1 + X}{V}$$

where V is the volume, in liters, of the sample and X is the blank correction obtained as described in Section F.

NOTES

(*a*) This method was first devised for use with membrane filters but we have recently found it practicable to use glass filters if these are first hardened by igniting them. Great care is needed to ensure that the filter is not frayed or fibers removed when it is handled by forceps. Because there is very little trouble from hygroscopicity with glass filters and no complications from electrostatic effects, their use is attractive.

(*b*) This preliminary washing and drying operation cannot conveniently be undertaken with more than about 100 filters at a time. A small but significant amount of soluble matter will be washed out of new filters and this is effectively removed by soaking the filters in water for a few minutes. A generous amount of water should be used.

(*c*) The use of foil minimizes sticking. Filters should be spread out on the foil without much overlap. Handle only with clean forceps.

(*d*) These lettered filters are used for blank corrections (*see* Sect. G) and should weigh within about 10 mg of the weight of any of the filters used in the determinations. Two such filters should be used per batch of samples being weighed. The use of a larger number (up to about six filters) improves the overall precision of the method but it is doubtful in most circumstances if this improvement merits the extra work.

(*e*) The drying procedure is somewhat arbitrary. The results obtained by drying filters at 75 C are effectively the same as those obtained using a desiccator at room temperature and the results have about the same precision. If higher oven temperatures are used some volatile oils may be lost but the principal objection is that filters become excessively curled and brittle. The amount of particulate matter on filters is so small and so thinly distributed that drying is very rapid and a 1-hr drying time is a very safe excess.

(*f*) The maximum volume of water consistent with not clogging the filter should be used. The weight of dried material on the membrane should, preferably, exceed 2 mg. Membrane filters clog by a positive blocking action and little is to be gained by increasing filtration times in excess of about 15 min. In the clearest oceans, samples of 2–5 liters may be used but generally with coastal waters 0.5–1 liter will suffice. With unknown samples a liter measuring cylinder should be filled and the sample added, a little at a time, until an idea of a suitable volume is obtained. Care is necessary as samples relatively free from particulate matter will occasionally clog filters rapidly if colloidal clay-like material is present from land drainage.

(*g*) There is evidence that with full suction some of the protoplasm of soft-bodied plants and animals may pass through the filter. It is *very important* that the sample be shaken vigorously before measuring out volumes for filtration to ensure that all material is kept in uniform suspension.

(*h*) If the washing water does not cover the filter before suction is applied parts of the

membrane may go unwashed and retain salts. Breaking the vacuum will not be necessary if filtration has slowed sufficiently before washing commences. Although this treatment with fresh water may disrupt some soft-bodied organisms the loss of material is probably very small if the washings are rapid and involves only a small volume of water.

(i) This washing step is important as salts retained by this portion of the filter, even when sucked dry, may give appreciable errors.

(j) (*See also* Note e). If determinations are made on a cruise the filters may be dried for about 30 min and stored at this stage, resting one on the other in a pillbox. The filtered material generally adheres well to the filters and will not be rubbed off by this procedure if reasonable care is exercised. On return to the shore-based laboratory the filters are removed and redried for 1 hr at 75 C as described in E.6. If very large numbers of filters are to be weighed at one time it may be impractical to use a desiccator. In these circumstances the filters should be spread out near the balance on a large sheet of clean foil and allowed to equilibrate with atmospheric moisture for about $\frac{1}{2}$ hour before weighing.

F. DETERMINATION OF BLANK

This method has no blank correction in the normally accepted sense of the term. However, filters are hygroscopic and may pick up or lose water from the air before the second weighings in amounts differing from before the initial weighings. This "error" may be as much as 0.5 mg and is allowed for by using the "blank" filters marked with letters. At least two of these, and preferably more, are taken with each batch of samples and an initial weight, W_1 , found as described in E.3. These filters are not used in the filtration equipment but are redried and treated in exactly the same manner as the sample filters as described in E.6, weighing them at the beginning, the end, and also (if more than two filters are used) in the middle of each batch of samples. If W_2 is the second weight of a lettered filter find X from the expression:

$$X = \text{mean of } W_2\text{-values} - \text{mean of } W_1\text{-values.}$$

X may have a positive or negative value which should not exceed about 0.5 mg.

For this correction it is assumed that the lettered filters behave exactly like the rest in a batch. This is a reasonable assumption if they are taken from the same box and have a tare within about 10 mg of any of the sample filters (on 70–100 mg).

IV.3. PIGMENT ANALYSIS

IV.3.I. SPECTROPHOTOMETRIC DETERMINATION OF CHLOROPHYLLS AND TOTAL CAROTENOIDS

INTRODUCTION

At present the only rapid chemical method known for estimating living plant matter in the particulate organic matter of sea water is to determine the characteristic plant pigments — the chlorophylls, carotenes and xanthophylls. Unfortunately the amount of organic substance associated with a given quantity of plant pigment is very variable, depending upon the class of the phytoplankter and its state of nutrition. (The factor for converting chlorophyll *a* to total plant carbon can vary between about 25 and 100.) The method described below determines the three chlorophylls commonly found in planktonic algae, chlorophylls *a*, *b*, and *c*. The carotenoid pigments (the carotenes and xanthophylls) are only estimated collectively in somewhat arbitrary units. If the plant population contains many myxophyceae some forms of phycobilin pigments may extract and interfere with all determinations except that of chlorophyll *a*. Fortunately this occurs only rarely in truly marine waters.

The following technique is taken largely from the method described by Richards (Richards with Thompson, *J. Marine Res.*, 11: 156, 1952) with later modifications (Creitz and Richards, *J. Marine Res.*, 14: 211, 1955) and a few minor changes by the present authors. The "specific plant unit" (SPU) defined by Richards has now attained almost international acceptance. This unit, used for chlorophyll *c* and the carotenoids, *approximates* to 1 g of dry pigment. The Richards equations, however, are capable of improvement in the light of more recent research. As well as the original equations we include modified versions given by Parsons and Strickland (*J. Marine Res.*, 21: 155, 1963), and the SCOR/UNESCO Working Group on photosynthetic pigments (*Monographs on oceanographic methodology*, Publ. Unesco, 1966). These lead to somewhat lower values for chlorophyll *a* and express the concentration of chlorophyll *c* in terms of milligrams of pigment rather than "specific plant units." It must be stressed that these and other equations are still liable to change according to which specific extinction values in the literature are considered most authoritative and whether or not values for "dried" or "undried" chlorophyll are used (*refer to* Parsons and Strickland, *J. Marine Res.*, 21: 155, 1963). Determinations of chlorophyll *c* by a trichromatic method will never be satisfactory when dealing with a low standing crop of phytoplankton, and a separate routine method for this pigment is desirable (*see* Sect. IV.3.III). The equations given by Parsons and Strickland also express carotenoid pigments in arbitrary units but factors are chosen according to whether the plant population is predominantly composed of members of the Chlorophyta and/or Cyanophyta or is dominated by species in the Chrysophyta and/or Pyrrophyta. This choice of factors enables a much better estimate of the total weight of carotenoid to be made than heretofore.

We have not included any calculations for astacin or animal pigments as suggested initially by Richards. In our experience artifacts are possible when using these calculations with a phytoplankton crop rich in dinoflagellates and the relationship between the apparent astacin content of the water and the planktonic invertebrate population is too tenuous for much useful ecological application.

An extraction with 90% acetone under the conditions described in the method which follows has been considered satisfactory by most workers for many years. We believe this still to be the case for most seawater samples, having regard to the accuracy considered adequate for most investigations of marine ecology. However, results are undoubtedly low in many instances because of the presence of plant cells that are not fully extracted. With certain species 50% or more of the pigments may be left behind in the cell. A change of solvent may be beneficial but will rarely ensure complete extraction so it is probably not worth the trouble to re-establish extinction coefficients for other solvents or solvent mixtures. The use of a sonic disintegrator has been recommended but we have not found sufficient improvement to merit the application of such equipment on a routine basis. The use of a tissue grinder, such as that recommended by Yentsch and Menzel (*Deep-Sea Res.*, 10: 221, 1963), is relatively convenient and improves results on many natural populations but even this approach fails to give complete extraction in a reasonable time with certain species. Fortunately bad cases are generally found only among the Chlorophyta and some benthic species, and reasonable results will be obtained with open-sea samples for much of the time, even without grinding. For work in lakes or shallow estuaries, the adequacy of extraction must be carefully checked.

The sensitivity of the method described below is adequate except where sample volumes are restricted or where the chlorophyll content of the water is below about 0.2 mg/m³. The precision decreases appreciably with concentrations below this level, becoming very poor if less than 0.1 mg/m³ is present. In these circumstances a fluorimetric determination is recommended. Such a method requires a sensitive fluorimeter and a suitable technique is described in Sections IV.3.IV and V.

Finally mention should be made of chlorophyll degradation products. The presence of chlorophyllide will go undetected and this pigment will be reported as an equivalent weight of chlorophyll. If phaeophytin or phaeophorbide are present in samples the extinction of 6650 Å (*see later*) will decrease and these pigments will go undetected and will be reported as if about half the amount of chlorophyll were present. Some idea of the amounts of phaeo-pigments present in a sample may be obtained by measuring extinctions (or fluorescence) before and after the acidification of extracts. Chlorophyll degradation products in samples of sea water are best determined by chromatography but this approach is lengthy and not suitable for routine application. The presence of such compounds can generally be ignored but large amounts may be found if bottom deposits are disturbed, if there has been very heavy grazing by zooplankton, or if samples are taken from just below the euphotic zone in the open sea. For this reason a procedure for the determination of phaeo-pigments has been added at the end of this section.

METHOD

A. CAPABILITIES

The limit of detection of plant pigments in sea water cannot be simply stated. An unlimited volume of water may be filtered for analysis; however, in practice, the volume filtered will rarely exceed 10 liters. The lower limit of detection for the filtration of 10 liters has not been statistically determined but appears to be of the

order of 0.02 mg/m^3 for chlorophyll *a* and 0.04 mg/m^3 for most other pigments except chlorophyll *c*.

1. CHLOROPHYLL *a* PRECISION AT THE $5 \mu\text{G}$ LEVEL

The correct value lies in the range:

Mean of n determinations $\pm 0.26/n^{\frac{1}{2}} \mu\text{g}$ chlorophyll *a*.

2. CHLOROPHYLL *b* PRECISION AT THE $0.5 \mu\text{G}$ LEVEL

The correct value lies in the range:

Mean of n determinations $\pm 0.21/n^{\frac{1}{2}} \mu\text{g}$ chlorophyll *b*.

3. PLANT CAROTENOIDS PRECISION AT THE $1.5 \mu\text{-SPU}$ LEVEL

The correct value lies in the range:

Mean of n determinations $\pm 0.15/n^{\frac{1}{2}} \mu\text{-SPU}$.

The precision of chlorophyll *c* determinations is variable and very poor, anywhere between ± 10 and $\pm 30\%$ of the amount being measured, and results are not *accurate*, almost always being too *high*.

B. OUTLINE OF METHOD

The larger zooplankters are removed by straining a sample of sea water through a nylon net of about $300\text{-}\mu$ mesh size and then the phytoplankters are filtered onto a Millipore AA filter or a glass filter. Pigments are extracted from the algae cells for estimation spectrophotometrically.

C. SPECIAL APPARATUS AND EQUIPMENT

Millipore filtration equipment designed to hold 47-mm diam membrane filters.

One 300-ml polyethylene wash bottle.

Stoppered graduated centrifuge tubes of 15-ml capacity having both glass and polyethylene stoppers.

"Small volume" spectrophotometer cells having a path length of 10 cm but holding 10 ml or less of solution.

D. SAMPLING PROCEDURE AND SAMPLE STORAGE

Adequate sampling of the euphotic zone or detrital layers for phytoplankton is a subject which is outside the scope of the present method. Once obtained, the final sample (generally 500 ml–5 liters in volume) is filtered through a small piece of clean 0.3-mm mesh nylon netting to remove the larger zooplankton. For open sea samples filtration of small volumes through a 0.15-mm mesh net will still not retain significant amounts of phytoplankton. The required volume of this filtrate should be measured by a polyethylene measuring cylinder into a polyethylene bottle. Two or three drops (*ca.* 0.1–0.2 ml) of magnesium carbonate suspension (*see* Sect. E.2) are added. The sample may then be stored in a cool dark place for a maximum of about 8 hr. It is desirable, however, that samples be filtered through a membrane filter at the time of collection.

Membrane filters can be stored by folding them in half (with the plankton

innermost) and storing them *in the dark* in a desiccator frozen to -20 C but only for a few weeks. This procedure almost always leads to low results and makes the extraction of chlorophyll more difficult; filters should be extracted without delay if at all possible.

E. SPECIAL REAGENTS

1. SPECIAL REAGENTS

Distill reagent grade acetone over about 1% of its weight of both anhydrous sodium carbonate and anhydrous sodium sulphite. Collect the fraction boiling at a constant temperature near 56.5 C (uncorrected). 100 ml of water is pipetted into a liter volumetric flask and acetone added to make the volume to exactly 1000 ml. The redistilled acetone should be stored in a tightly stoppered dark glass bottle and the 90% reagent prepared in moderately small amounts (say 1 liter at a time) for use. This reagent is conveniently dispensed from a polyethylene wash bottle which should be kept nearly full. If good quality reagent acetone is available, it should be shaken with a little granular anhydrous sodium carbonate and decanted directly for use.

2. MAGNESIUM CARBONATE SUSPENSION

Add approximately 1 g of finely powdered magnesium carbonate (light weight or "Levis" grade) of analytical reagent quality to 100 ml of distilled water in a stoppered Erlenmeyer flask. Shake vigorously to suspend the powder *immediately* before use.

F. EXPERIMENTAL

1. Invert the polyethylene bottle containing the sample (Sect. D) into the funnel of the Millipore filter equipment fitted with either a 47-mm diam Millipore AA filter or a 4.5-cm Whatman GF/C glass filter paper (Note *a*). The bottle need not be rinsed but the contents should be shaken vigorously, before filtration is commenced. If not added previously, introduce about 1 ml of magnesium carbonate suspension to the last few hundred milliliters of sample being filtered (Note *b*).

2. Drain the filter thoroughly under suction before removing it from the filtration equipment and if a Millipore filter is used trim away the peripheral excess of unstained membrane with clean scissors (Note *c*). Store the filter if necessary but if possible extract the pigment without delay (Sect. D).

3. Place the filter in a 15-ml stoppered graduated centrifuge tube. If a Millipore filter was used add approximately 8 ml of 90% acetone, stopper the tube, and dissolve the filter by shaking the tube vigorously. If a glass paper was used add approximately 10 ml of 90% acetone, stopper the tube, and disperse and disintegrate the paper by shaking the tube vigorously (Note *d*). Allow the pigments to be extracted by placing the tube in a refrigerator in *complete darkness* for about 20 hr (Notes *e* and *f*). It is good practice to shake the tubes vigorously once more after they have been 1 or 2 hr in the refrigerator.

4. Remove tubes from the refrigerator and let them warm up in the dark nearly to room temperature. Add 90% acetone to make the extracts from Millipore filters up to exactly 10.0 ml and those from glass filters to exactly 12.0 ml (Note *g*).

Centrifuge the content of the tubes for 5–10 min (Note *h*) having replaced the glass stoppers on the centrifuge tubes with plastic stoppers to prevent breakage during centrifugation.

5. Decant the clear supernatant liquid into a 10-cm-path-length spectrophotometer cell designed to hold 10 ml or less of liquid. In the event of extinction values exceeding about 1.3 the measurements described below should be made with 2.5-cm or 1-cm cells and the extinction values multiplied by 4 or 10, respectively, to normalize them to the values expected with a 10-cm cell. If 12 ml of acetone is used with glass papers multiply the extinction values by 1.2 to normalize them to the values expected from 10 ml of extract.

6. Without delay measure the extinction of the solution against a cell containing 90% acetone (Note *i*) at 7500, 6650, 6450, 6300, and 4800 Å (Note *j*). If the Richards equations are to be used for carotenoids (*see below*) a further measurement at 5100 Å is required, and if the SCOR/UNESCO equations are used the measurement at 6650 Å should be replaced by one at 6630 Å. Record the extinction values to the nearest 0.001 unit in the range 0–0.4 and the nearest 0.005 for extinctions exceeding about 0.4. Correct the extinctions at each wavelength by the procedure described in Section G below.

7. Calculate the concentration of pigments in sea water from the equation

$$\text{mg (or m-SPU) pigment/m}^3 = \frac{C}{V}$$

where *C* is a value obtained from the following equations and *V* is the volume of sea water filtered in liters. When the Parsons-Strickland equations are used values for chlorophylls *a*, *b*, or *c* will be in mg/m³ and those for carotenoids in a milligram. If the “classical” Richards equations are used values are in mg/m³ only for chlorophylls *a* and *b*. The Richards m-SPU is used for chlorophyll *c* and is considerably greater than the milligram. The m-SPU is considerably smaller than the milligram if carotenoids are mainly fucoxanthin or peridinin which are present in Chrysophyta or Pyrrophyta.

8. Formulae: (R = Richards, P.S. = Parsons and Strickland, S.U. = SCOR/UNESCO. *E* stands for the extinction values, at wavelengths indicated by the subscripts, measured in 10-cm cells *after* correcting for a blank as described in Section G.2 below.)

$$\begin{aligned} \text{R.} \quad C (\text{chlorophyll } a) &= 15.6 E_{6650} - 2.0 E_{6450} - 0.8 E_{6300} \\ \text{P.S.} \quad C (\text{chlorophyll } a) &= 11.6 E_{6650} - 1.31 E_{6450} - 0.14 E_{6300} \\ \text{S.U.} \quad C (\text{chlorophyll } a) &= 11.64 E_{6630} - 2.16 E_{6450} + 0.10 E_{6300} \end{aligned}$$

$$\begin{aligned} \text{R.} \quad C (\text{chlorophyll } b) &= 25.4 E_{6450} - 4.4 E_{6650} - 10.3 E_{6300} \\ \text{P.S.} \quad C (\text{chlorophyll } b) &= 20.7 E_{6450} - 4.34 E_{6650} - 4.42 E_{6300} \\ \text{S.U.} \quad C (\text{chlorophyll } b) &= 20.97 E_{6450} - 3.94 E_{6630} - 3.66 E_{6300} \end{aligned}$$

$$\begin{aligned} \text{R.} \quad C (\text{chlorophyll } c) &= 109 E_{6300} - 12.5 E_{6650} - 28.7 E_{6450} \\ \text{P.S.} \quad C (\text{chlorophyll } c) &= 55 E_{6300} - 4.64 E_{6650} - 16.3 E_{6450} \\ \text{S.U.} \quad C (\text{chlorophyll } c) &= 54.22 E_{6300} - 14.81 E_{6450} - 5.53 E_{6630} \end{aligned}$$

¹ Filtration, using Whatman GF/C discs in all-glass apparatus may be easier than centrifugation.

- R. C (Plant carotenoids) = $7.6 (E_{4800} - 1.49 E_{5100})$, without regard to nature of crop.
- P.S. C (Plant carotenoids) = $4.0 E_{4800}$, if crop predominately Chlorophyta or Cyanophyta.
 = $10.0 E_{4800}$, if crop predominately Chrysophyta or Pyrrophyta.

When large numbers of samples are involved, considerable time can be saved by converting the simultaneous equations into a nomographic form (Duxbury and Yentsch, *J. Marine Res.*, 15: 92-101, 1956). The nomographs given in Table XV are for use with the revised equations for ascertaining chlorophylls as discussed by Parsons and Strickland (*J. Marine Res.*, 21: 155-163, 1963) and have been taken from Stephens (*J. Fish. Res. Bd. Canada*, 22: 1575, 1966).

The following description for the use of the nomographs is given for chlorophyll *a*. By using the appropriate nomographs, the estimation of chlorophylls *b* and *c* follow a similar procedure. The nomographs are set up using $m\mu$ as units, i.e., E_{645} (nomograph) $\equiv E_{6450}$ (P.S. equations above).

Corrected optical densities at 6450 and 6300 Å (E_{6450} and E_{6300}) are plotted on their respective lines and joined with a straight edge. The intercept on Line *Q* is then lined up with the corrected optical density at 6650 Å (E_{6650}). The intercept on the C_a line then gives the concentration of pigment.

NOTES

(a) Millipore filters have the advantage that they dissolve in acetone completely, give no complications at the centrifugation stage, and require no particular precautions during filtration. However, unless great care is taken, undesirably high blanks will occur when using Millipore filters, making the determination of small concentrations of carotenoids difficult. These filters are expensive. Glass filters are cheaper and their use results in practically no blank. They are recommended if a cell grinding step is required to give better extraction (Note *d*), although care must be taken when filtering samples through the comparatively coarse glass filters and trouble is experienced at the centrifugation stage. A manostat (there are several cheap commercial laboratory units based on the cartesian diver) must be used with glass papers to ensure that the suction never exceeds $\frac{1}{3}$ - $\frac{1}{2}$ atm or else pigment may pass through the filters. *Millipore filters must be used if chlorophyll c is to be determined on the same extract by method IV.3.III.*

(b) The magnesium carbonate is added at this stage to ensure that the phytoplankton chlorophyll is prevented from becoming acid with the resulting decomposition to give phaeophytin pigments. We have some doubts of the efficacy of such an addition compared with, say, the addition of a completely soluble organic base but the use of magnesium carbonate is established practice and doubtlessly has some value as a precautionary measure. Care should be taken to see that Millipore filtration equipment, centrifuge tubes, and spectrophotometer cells are kept free from acid and that the filter is not touched with acidic fingers.

(c) The troublesome blank, measured at 7500 Å (Sect. G), found with Millipore filters is caused almost entirely by the salt left in the filter at this stage which subsequently "salts out" membrane material from the acetone. The blank can be greatly reduced if filters are sucked dry of sea water very thoroughly at this stage and as much as possible of the unwanted peripheral filter is cut away.

(d) If poor extraction is anticipated use a glass filter and after filtration push this to the bottom of a "Potter" type grinder holding about 20 ml. Following Yentsch and Menzel we have used the Arthur H. Thomas grinder No. 4288-B fitted to an ordinary laboratory stirring motor. About 2 ml of 90% acetone should be added and the grinder run for 1-2 min *in subdued light*.

The tube should be pushed up and down the pestle during the extraction but for much of the time the pestle should be hard against the bottom of the tube. After use, the pestle is rinsed into the tube with a few milliliters of 90% acetone which is also used to transfer the contents of the grinder tube to a 15-ml centrifuge tube. The total volume in the centrifuge tube should not exceed 10 ml. The contents should be left in the dark for a few hours to ensure the complete removal of all extractable pigments.

(e) During the extraction period pigments are very photosensitive and neither extracts nor the unextracted filters should be exposed to strong sunlight or else chlorophyll values will be reduced to a small fraction of their initial level in less than 1 hr. Tubes must be stored in complete darkness.

(f) The period of extraction should be about 15–20 hr. After this time the rate of further extraction is too slow for an extension to be merited. Pigment extracts should preferably be kept chilled but they can be kept at room temperature for many hours without deterioration. If cells are pretreated in a grinder (Note d) any further extraction is slow, but for safety, tubes should be stored for a few hours to complete the leaching of cell fragments.

(g) The use of 10 ml of solution in a 10-cm-path-length cell is recommended for maximum sensitivity. Greater sensitivity can be obtained by using 10-cm cells containing less than 10 ml but this is scarcely great enough to warrant the increased manipulative difficulties. The ultimate sensitivity is, in practice, more dependent on the size and reproducibility of blanks. Glass filters disintegrate to pulp, instead of dissolving in acetone, and the pulp retains at least 1 ml of solvent. To ensure enough extract to fill a 10-cm cell, therefore, 12 ml of acetone, instead of 10 ml, should be used.

(h) Centrifugation should be as efficient as possible when Millipore filters are used. In most small centrifuges 3000–4000 rpm for about 10 min is generally satisfactory but the efficiency should be tested with each instrument used. Difficulties may be encountered when centrifuging down the glass pulp from glass filters. Tubes should be centrifuged for 1–2 min to pack most of the fibers to the bottom. The centrifuge is then stopped, the tubes removed, and glass fibers adhering to the walls of the tubes above the level of the solvent are taken down into the bulk of the liquid by gently splashing the walls by flicking the tubes. The tubes are then returned to the centrifuge and spun for about 5 min. If this precaution is not taken some fibers held above the solvent layer may enter the spectrophotometer cell.

(i) These extracts should not be allowed to evaporate and should be exposed only to subdued light for the briefest possible period. The measurement of extinction against acetone (instead of against water) is recommended as acetone has markedly less absorption in a 10-cm cell at 7500 Å than has distilled water.

(j) The wavelength setting of the spectrophotometer used should be checked against a standard hydrogen or neon line source as the precision of the present method depends upon settings being correct to better than 20–30 Å. With quartz prisms at wavelengths exceeding 6000 Å very slight movements of the optical system, brought about by vibrations, etc., can easily result in errors of 50 Å or more in wavelength settings. If a suitable lamp is not available check the extinction of a suitably concentrated plant extract and adjust the spectrophotometer, if necessary, until a maximum extinction is obtained at 6630 Å.

G. DETERMINATION OF BLANK

1. CELL-TO-CELL BLANKS

As the precise values of comparatively small extinctions have to be measured, corrections for all optical inequalities become important. Fill both spectrophotometer cells with 90% acetone and find the "cell-to-cell" blank of the sample cell against the reference cell *at all wavelengths used in the method*. Correct *all* extinction values by this cell-to-cell blank which may amount to 0.01 or more.

2. TURBIDITY BLANKS

If glass papers are used there should be only a very small blank. This is

measured by the spectrophotometer reading at 7500 where there is known to be no absorption of light from pigments. We have sometimes found a small negative blank for reasons which are not clear. In any case the value positive or negative should not exceed about 0.002 and may be corrected for cell-to-cell blank and used for the extinctions at all wavelengths.

A certain amount of colloidal material remains after the solution of an AA Millipore filter, even after centrifugation. The extinction from this material depends on the wavelength of light used, increasing at shorter wavelengths because of light scattering effects.

The extinction at 7500 Å is corrected for any cell-to-cell blank at this wavelength and the resulting extinction (E_b) is multiplied by a factor f to give the turbidity blank extinction to be used with spectrophotometer readings at other wavelengths.

$$\text{Total blank correction} = \text{cell-to-cell blank} + (f \times E_b)$$

where f has the values shown below:

<i>Wavelength</i>	<i>f</i>
6650	1
6450	1
6300	1
5100	2
4800	3

It must be stressed that these values for f are *very approximate*. Extinction values at 4800 Å should undoubtedly be corrected by a greater blank than the one obtained at 7500 Å but the value of 3 is so approximate that there is no substitute for having low E_b values. If a good correction is required E_b must not exceed about 0.02.

ADDENDUM TO IV.3.I. SPECTROPHOTOMETRIC DETERMINATION OF PHAEO-PIGMENTS

INTRODUCTION

Chlorophyll degradation products may at times constitute a significant fraction of the total green pigments in sea water. These degraded forms of inactive chlorophyll interfere with the spectrophotometric determination of chlorophylls because they absorb light in the same region of the spectrum as chlorophyll. Pigment samples from the aphotic zone, sediments, and samples from areas of high zooplankton grazing are particularly likely to contain inactive chlorophyll products. Chemically these may consist predominantly of phaeophytin and phaeophorbide (phaeo-pigments) but sometimes large quantities of chlorophyllide may also be present. In the following method it is possible to obtain a measure of the total quantity of chlorophyll *a* and phaeophytin *a* plus phaeophorbide *a*, but not of chlorophyllide *a* or the phaeophytins and phaeophorbides of other chlorophylls. For a complete analysis of all chlorophylls and their degradation products there is probably no alternative to chromatographic methods which are generally too tedious for the routine analysis of a large number of samples. For a routine observation, however, it is often sufficient to obtain a measure of the amount of non-active chlorophyll *a* in terms of the quantity of phaeo-pigments present. Two similar procedures have been described for this determination (Moss, *Limnol. Oceanog.*, 12: 335, 1967; Lorenzen, *Limnol. Oceanog.*, 12: 343, 1967). The procedure employed here is written as an addendum to the procedure for plant pigment analysis (IV.3.I) and employs equations in the second of the two references given above.

METHOD

A. CAPABILITIES

1. PHAEOPHYTIN *a* PRECISION AT THE 0.5 μg LEVEL

The correct value lies in the range:

$$\text{Mean of } n \text{ determinations } \pm 0.05/n^{\frac{1}{2}} \mu\text{g phaeophytin } a.$$

2. LIMIT OF DETECTION

The limit of detection will depend on the total amount of sea water filtered but for all measurements the initial extinction at 6650 Å should be greater than 0.2.

B. OUTLINE OF METHOD

The extinction of an acetone extract of plant pigment is measured before and after treatment with dilute acid. The change following acidification is used as a measure of the quantity of phaeo-pigments in the original sample.

C. SPECIAL APPARATUS AND EQUIPMENT

See Section IV.3.I.C.

D. SAMPLING PROCEDURE AND SAMPLE STORAGE

See Section IV.3.I.D.

E. SPECIAL REAGENTS

Reagents 1 and 2, see Section IV.3.I,E.

3. HYDROCHLORIC ACID

Dilute 50 ml of concentrated hydrochloric acid to 100 ml with distilled water.

F. EXPERIMENTAL

PROCEDURE

1. Carry out procedure in Section IV.3.I,F., procedures 1-5.
2. Measure the extinction of the extract at 6650 and 7500 Å. Add two drops of dilute hydrochloric acid to the cuvette (Note *a*), mix (Note *b*), and remeasure the extinction at 6650 and 7500 Å.
3. Subtract each 7500 Å reading from the corresponding 6650 Å extinction and use the following equations to calculate the concentration of chlorophyll *a* and phaeo-pigments in the sample (Note *c*):

$$\text{Chl } a \text{ (mg/m}^3\text{)} = \frac{26.7(665_o - 665_a) \times v}{V \times l}$$

$$\text{Phaeo-pigments (mg/m}^3\text{)} = \frac{26.7(1.7[665_a] - 665_o) \times v}{V \times l}$$

where 665_o is the extinction at 6650 Å before acidification, 665_a the extinction at 6650 Å after acidification, *v* the volume of acetone used for extraction (ml), *V* the volume of water filtered (liters), and *l* the path length of the cuvette (cm).

NOTES

(*a*) If the extraction of pigment has been made using acetone soluble filters, the addition of a small amount of hydrochloric acid will cause a transient turbidity which disappears on mixing.

(*b*) The samples are best mixed by holding a small piece of aluminum foil over the mouths of the cuvettes and inverting them several times. The destruction of chlorophyll *a* to phaeophytin is not instantaneous and the sample should be allowed to stand for 4-5 min before being measured again. Rinse the cuvette thoroughly with 90% acetone after each determination to ensure that no acid is carried over when the next 665_o reading is taken.

(*c*) For convenience, the corresponding equation for the determination of chlorophyll *a* has been included here. The value for the specific absorption coefficient for chlorophyll *a* is the same as is employed in Section IV.3.I,F (Parsons and Strickland equations).

IV.3.II. SCOR/UNESCO PROCEDURE FOR CHLOROPHYLLS

INTRODUCTION

The following procedure was agreed to by a SCOR/UNESCO working group and has been published by Unesco in *Monographs on Oceanographic Methodology*.

METHOD

CONCENTRATION OF SAMPLE

Use a volume (Note *a*) of sea water which contains about 1 μg chlorophyll *a*. Filter (Note *b*) through a filter (Note *c*) covered by a layer of MgCO_3 (Note *d*).

STORAGE

The filter can be stored in the dark over silica gel at 1 C or less for 2 months but it is preferable to extract the damp filter immediately and make the spectrophotometric measurement without delay.

EXTRACTION

Fold the filter (plankton inside) and place it in a small (5–15 ml) glass, pestle-type homogenizer. Add 2–3 ml 90% acetone. Grind 1 min at about 500 rpm. Transfer to a centrifuge tube and wash the pestle and homogenizer 2 or 3 times with 90% acetone so that the total volume is 5–10 ml. Keep 10 min in the dark at room temperature. Centrifuge (Note *e*) for 10 min at 4000–5000 *g* (Note *f*). Carefully pour into a graduated tube so the precipitate is not disturbed and if necessary dilute (Note *g*) to a convenient volume (Note *h*).

MEASUREMENT

Use a spectrophotometer with a band-width of 30 Å or less, and cells with a light path of 4–10 cm (Note *i*). Read the extinction (optical density, absorbance) at 7500 (Note *j*), 6630, 6450, and 6300 Å against a 90% acetone blank.

CALCULATION

Subtract the extinction at 7500 Å from the extinctions at 6630, 6450, and 6300 Å. Divide the answers by the light path of the cells in centimeters. If these corrected extinctions are E_{6630} , E_{6450} , and E_{6300} the concentrations of chlorophylls in the 90% acetone extract as $\mu\text{g}/\text{ml}$ are given by the SCOR/UNESCO equations (refer to Section IV.3.I). If the values are multiplied by the volume of the extract in milliliters and divided by the volume of the seawater sample in liters, the concentration of the chlorophylls in the sea water is obtained as $\mu\text{g}/\text{liter}$ (= mg/m^3).

NOTES

(*a*) The amount of chlorophyll *a* should be less than 10 μg , otherwise a second extraction with 90% acetone might be necessary. With ocean water about 4–5 liters of sample should be used; with coastal and bay waters, sometimes one tenth of this amount is sufficient.

(*b*) Use no more than two thirds of full vacuum.

(*c*) Satisfactory filters include paper (Albet), cellulose (Cella "grob"), and cellulose ester (0.45–0.65 μ pore-size); the filter should be 30–60 mm in diameter. If these filters clog with inorganic detritus, use Schleicher & Schüll 575.

(d) Add about 10 mg MgCO_3 /cm² filter surface, either as a powder or as a suspension in filtered sea water.

(e) A swing-out centrifuge gives better separation than an angle centrifuge.

(f) If a stoppered, graduated centrifuge tube is used, the extract can be made up to volume and the supernatant carefully poured or pipetted into the spectrophotometer cell.

(g) If turbid, try to clear by adding a little 100% acetone or distilled water or by centrifuging again.

(h) This depends on the spectrophotometer cell used. The volume should be read to 0.1 ml.

(i) Dilute with 90% acetone if the extinction is greater than 0.8.

(j) If the 7500 Å reading is greater than 0.005/cm light path, reduce the turbidity as in Note g.

IV.3.III. DETERMINATION OF CHLOROPHYLL C

INTRODUCTION

The trichromatic method, described in IV.3.I, has, inherently, a positive error and a poor precision for chlorophyll *c*, which becomes worse the smaller the extinctions being measured and the larger the blanks. A separate method for chlorophyll *c* is required and the present method is based on the procedure given by Parsons (*J. Marine Res.*, 21: 164, 1963). It is somewhat lengthy and tedious for routine work but can be used conveniently for small numbers of samples and is designed specifically for samples of low pigment content where a precise chlorophyll *c* value is required.

The method described below has the advantage that it may be used in conjunction with method IV.3.I using acetone extracts after the other pigments have been determined.

METHOD

A. CAPABILITIES

The lower limit of detection, with the filtration of 10 liters, has not been statistically determined but will be about 0.05 mg/m³.

PRECISION AT THE 5 μG LEVEL

Mean of *n* determinations $\pm 1.5/n^{\frac{1}{2}}$ μg chlorophyll *c*.

Unlike the trichromatic method, we believe that there is no systematic error in this method although certain interferences are possible (*see later*).

B. OUTLINE OF METHOD

The acetone extract of the phytoplankton in a water sample is treated with a dilute sodium chloride solution and extracted with *n*-hexane. The extinction of the aqueous acetone layer containing the chlorophyll *c* is then measured by a spectrophotometer at 4500 Å before and after adding acid, which converts the chlorophyll *c* to the phaeo-pigment. The chlorophyll *c* content of the sample is calculated from the resulting decrease of extinction.

C. SPECIAL APPARATUS AND EQUIPMENT

See IV.3.I, Section C.

60-ml pear-shaped separatory funnels with the stems cut short. Do not grease the taps but grind them into place with a little fine emery and water, if necessary, to ensure a snug fit.

D. SAMPLING PROCEDURE AND SAMPLE STORAGE

See IV.3.I, Section D.

E. SPECIAL REAGENTS

See IV.3.I, Section E, for reagents 1 and 2. In addition a little 100% acetone, purified as described in IV.3.I, is required.

3. *n*-HEXANE

Use analytical quality material and, for safety, redistill the solvent for use from a little sodium carbonate.

4. SODIUM CHLORIDE SOLUTION

Dissolve 0.5 g analytical reagent quality sodium chloride in 1000 ml of distilled water.

F. EXPERIMENTAL

PROCEDURE

1. Determine the pigments exactly as described in IV.3.I, Section F 1–5 using Millipore AA filters. The measurement of extinctions to obtain values for chlorophylls and carotenoids is, of course, not essential to the *present* method but may as well be done as the required extracts will have been prepared. The whole 10 ml should be drained from the centrifuge tube into the spectrophotometer cell.

2. Transfer the 10 ml of 90% acetone extract from the cell into a clean *dry* separatory funnel. Drain the cell thoroughly but *do not* rinse.

3. Add 3.5 ml of sodium chloride solution from a 5-ml graduated pipette and 13.5 ml of hexane from a 20- or 25-ml graduated pipette. Shake the funnel gently for 1 min (Note *a*).

4. Run off exactly 8.5 ml of the lower aqueous–acetone phase into a 15-ml graduated centrifuge tube. Add 100% acetone to make the volume to exactly 10.0 ml and centrifuge if necessary (Note *b*). Decant the clear liquid into an *acid free* 10-cm-path-length spectrophotometer cell designed to hold 10 ml or less of liquid (Note *c*). Work only in diffuse light.

5. Without delay measure the extinction against a cell containing 90% acetone at 4500 Å (E_1). Add one *small* drop (*ca.* 0.02 ml) of concentrated hydrochloric acid to the extract, stopper the cell, and invert it several times to mix the acid and acetone. Re-read the extinction *immediately* at 4500 Å (E_2) (Note *c*).

6. Calculate the amount of chlorophyll *c* present from the formula (Note *d*):

$$\text{mg chlorophyll } c/\text{m}^3 = \frac{17.5 (E_1 - E_2)}{V}$$

where V is the volume of sea water filtered in liters.

NOTES

(*a*) The addition of this saline solution precipitates and coagulates the Millipore membrane material which should collect at the interface of the two liquids. All pigments except chlorophyll *c* are removed from the lower layer (*see* Note *d*).

(*b*) If care is taken to avoid particles of precipitated membrane material, 10.0 ml of clear solution should result. Centrifugation at this stage should rarely be necessary but the 15-ml centrifuge tubes make convenient measuring vessels.

(*c*) The use of this technique of converting chlorophyll *c* to phaeophytin *c* and measuring the corresponding *decrease* in extinction at 4500 Å gives a method having less sensitivity than could be obtained if the extinction at 4500 Å alone were measured but the procedure is more specific for chlorophyll *c* and removes the possibility of interference from traces of carotenoids, etc. It should be noted that the spectrophotometer cell must be completely free from the acid used in one determination before the non-acidified reading of the next determination is at-

tempted. Cells should be cleaned by a generous washing with 100% acetone between determinations.

(d) There is no blank determination, as such, in this method. The method is difficult to calibrate in the absence of a pure source of chlorophyll *c* and the factor given here, obtained by taking known weights of chlorophyll *c* throughout the whole procedure, is probably applicable directly with all correctly aligned spectrophotometers. The only compounds known to give interference are chlorophyllides *a* and *b*, as some of these would remain with the chlorophyll *c* in the acetone layer and be converted on acidification to the corresponding phaeophorbides, with a spectral shift. The present technique minimizes the interference from such compounds and fortunately it does not appear likely that they will often be present in significant amounts in samples from the open sea.



IV.3.IV. FLUOROMETRIC DETERMINATION OF CHLOROPHYLLS

INTRODUCTION

The method described here is based on the use of the Turner fluorometer as suggested by C.S. Yentsch and D.W. Menzel (*Deep-Sea Res.*, 10: 221, 1963) and subsequently investigated by Holm-Hansen et al. (*J. Conseil, Conseil Perm. Intern. Exploration Mer*, 30: 3, 1965). The method is not so accurate as the spectrophotometric approach but has the convenience of speed and the requirement of much smaller sample volumes for a given sensitivity. Only chlorophyll *a* is determined.

METHOD

A. CAPABILITIES

The limit of detection will depend upon the volume of water filtered and the sensitivity of the fluorometer. With a 2-liter sample about 0.01 mg chlorophyll *a*/m³ should be detectable with surety. The precision is very much dependent on the amount of pigment being determined but *P* (see NOTE ON STATISTICAL LIMITS) is better than 8% of any value of chlorophyll *a* exceeding 0.5 mg/m³.

B. OUTLINE OF METHOD

Extracts obtained as described in IV.3.I are measured fluorometrically with the Turner fluorometer.

C. SPECIAL APPARATUS AND EQUIPMENT

See IV.3.I,C but only glass filters should be used. The Turner fluorometer is fitted with the "high sensitivity" door, F.4T4-BL lamp, Wratten 47B or Corning CS.5-60 filter for the excitation light and Corning CS.2-64 filter for the emitted light.

D. SAMPLING PROCEDURE AND SAMPLE STORAGE

See IV.3.I,D.

E. SPECIAL REAGENTS

See IV.3.I,E.

F. EXPERIMENTAL

The extracts from 0.25–2 liters, obtained exactly as described in IV.3.I,F.1–5, but using *only 10.0 ml* of 90% acetone, are measured in a Turner fluorometer with the scale "zeroed" for each door opening against a tube of 90% acetone. Provided that phaeo-pigments are absent:

$$\text{mg chlorophyll } a/\text{m}^3 = F_D \times R$$

where *R* is the reading of the fluorometer and *F_D* is a factor for each door (see Section H below). Do not use solutions which necessitate the use of door 1 or which give readings much greater than 50 on door 3. With such solutions the concentrations of chlorophyll are too great for there to be linearity between fluorescence and concentration. If solutions are too concentrated dilute 3 ml (pipette) of extract with 3 ml of 90% acetone in a second clean, dry tube.

G. DETERMINATION OF BLANK

As the conditions used in the fluorometer are specific for chlorophyll and this is not introduced as a contaminant in reagents we have never found a blank, *per se*, with this method. The output (probably from scatter) of a tube of 90% acetone is not negligible on door 10 and the instrument should be zeroed against a tube of 90% acetone with all doors immediately prior to use.

H. CALIBRATION

This must be done on extracts from marine phytoplankton as pure chlorophyll *a* is difficult to obtain. With the conditions recommended in this method the instrument responds almost exclusively to chlorophyll *a* but there is a slight and variable response to other chlorophylls. For this reason factors vary a little from species to species. We recommend that a healthy culture of *Skeletonema costatum* or, even more, a mixture of about equal amounts (by pigment) of *Skeletonema costatum*, *Coccolithus huxleyii*, and *Peridinium trochoidium* be used as a source of chlorophyll. If such cultures are not available natural populations can be used but there is then always uncertainty as to the presence of phaeo-pigments. Take samples from near the surface in eutrophic waters under early "bloom" conditions.

Extract sufficient culture or natural population to give 50 ml of extract having a reading of about 50 on door 3 of the fluorometer (R_3). Determine the amount, C_a , as described in IV.3.I.F, having ensured that the wavelength alignment of the spectrophotometer is carefully adjusted. Determine F_3 for door 3 from the formula:

$$F_3 = \frac{C_a}{R_3}$$

Dilute a known volume of the extract with a known volume of 90% acetone so that readings greater than 50 are obtained for doors 10 and 30 with known new values of C_a . Calculate F_{10} and F_{30} from expressions analogous to the above.

Note: Generally it is so little extra trouble to determine both chlorophyll and phaeo-pigments together that the approach given in the following addendum is recommended for work with samples other than phytoplankton cultures.

ADDENDUM TO IV.3.IV. FLUOROMETRIC DETERMINATION OF PHAEO-PIGMENTS

METHOD

This procedure is taken from Holm-Hansen, et al. (*J. Conseil, Conseil Perm. Intern. Exploration Mer*, 30: 3, 1965) and is essentially the same as IV.3.IV except that after the first reading, R_B , is taken on the fluorometer, the tube is removed, and 2 drops of 5% v/v hydrochloric acid are added. The contents of the tube are mixed by inverting once or twice, and a second reading, R_A , is taken between 30 and 60 sec later, after a stable value is reached.

Note: The tube must be washed out well with 90% acetone between determinations to make sure that no acid remains.

The precision varies from sample to sample and is not so high as the precision obtainable when only measurements on unacidified solutions are made. Quantities of phaeo-pigments less than 10% of the total pigment should be interpreted with caution.

$$\text{mg chlorophyll } a/\text{m}^3 = F_D \frac{\tau}{\tau - 1} (R_B - R_A)$$

$$\text{mg phaeo-pigment}/\text{m}^3 = F_D \frac{\tau}{\tau - 1} (\tau R_A - R_B)$$

where F_D is the door factor and τ is a ratio obtained as described below. There is no blank *per se* with this method.

CALIBRATION

The door factors, F_D , are identical with those obtained in IV.3.IV,H and should be obtained in the same way, ideally from mixed cultures. The ratio, τ , is the ratio $\frac{R_B}{R_A}$ obtained on any extract free from phaeo-pigments but, preferably, an extract used for standardization. This ratio, which should be near to 2.2 with the equipment specified here, must be obtained by making all measurements on one door, the R_B value being as near to 100 as practicable. The value of τ is not quite constant, especially if a great deal of chlorophyll *c* is present in some extracts, so slightly negative values for phaeo-pigments may sometimes be obtained. A single formula is good enough, however, for most field work and will estimate the fraction of phaeo-pigments present in samples sufficiently well for most ecological studies. For work of the highest precision use the method given in the Addendum to IV.3.I.

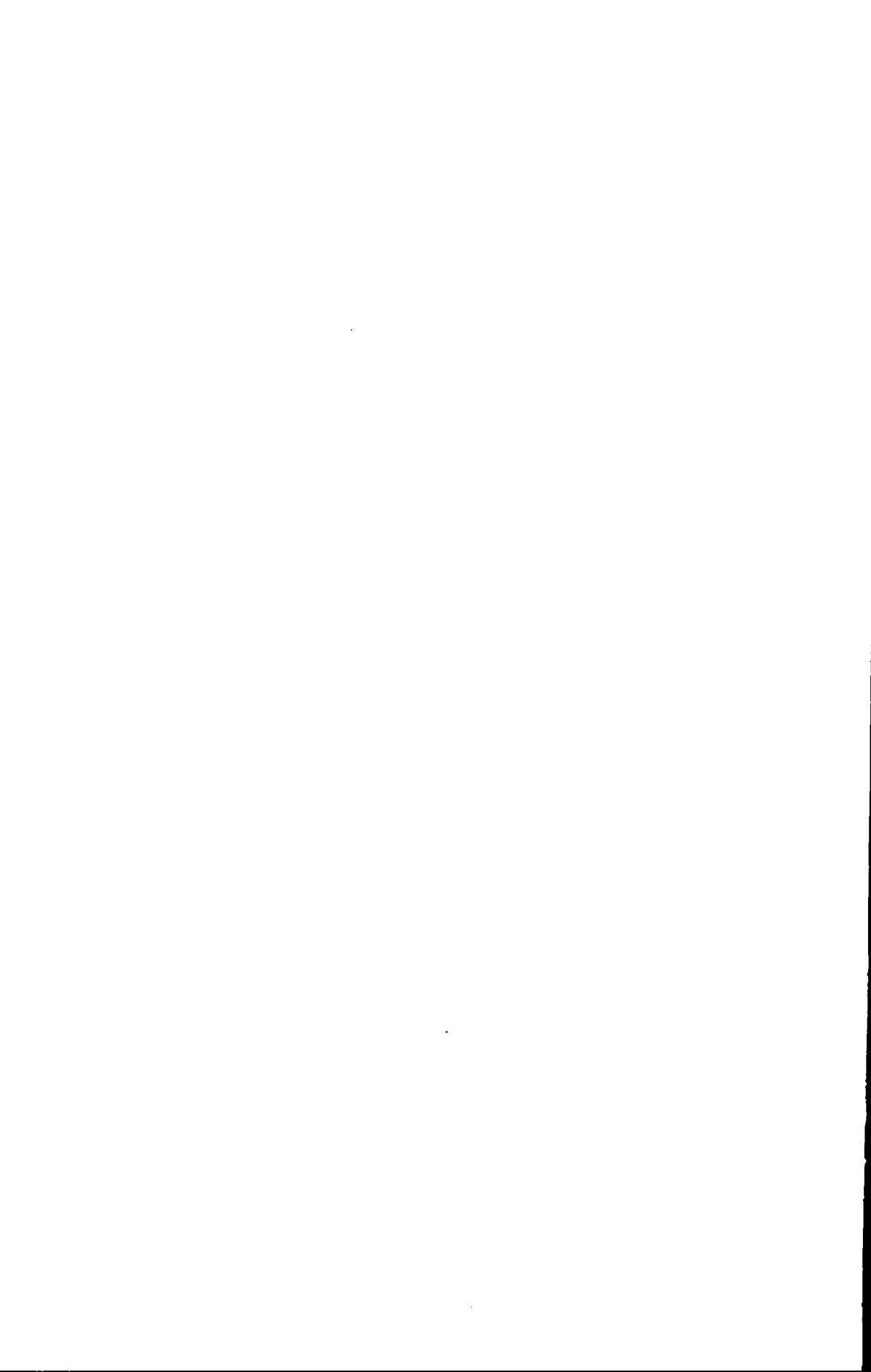

IV.3.V. AUTOMATED ESTIMATION OF CHLOROPHYLL PIGMENTS BY FLUORESCENCE

INTRODUCTION

This method derives from a report by C. J. Lorenzen (*Deep-Sea Res.*, 13: 223, 1966) with some further work reported by one of us (Strickland, *Deep-Sea Res.*, In Press). Sea water is pumped through a cuvette in a specially sensitive Turner fluorometer and the fluorescence of the living plankton cells measured directly. The method is an invaluable semiquantitative tool for measuring the surface concentration of phytoplankton in a ship underway but requires very frequent standardization if it is to be used as a precise technique in eutrophic waters. No generally applicable precision can be quoted. The method will measure between about 0.05 and 20 mg chlorophyll *a*/m³. Greater quantities (such as found in red-tide blooms) can be handled if a specially constructed door 1 is made with a very small hole.

METHOD

A. SPECIAL APPARATUS AND EQUIPMENT

A Turner fluorometer, Model III with a flow-through door and cuvette ($\frac{3}{8}$ -inch orifices). Use a high intensity F4T.5. blue lamp with a blue Corning filter CS.5-60 for the excitation light and a red Corning filter CS.2-64 for the emitted light. The standard photomultiplier *must* be replaced by a red sensitive one (R136).

Sea water or distilled water should be drawn through the cuvette using a small pump and a three-way tap. Depending on the source of the sample some form of debubbling device will generally be needed (*see* Section IV.13,C).

Using a heat exchanger (Section IV.13) may prevent condensation of cold water on the cuvette when the sample is below room temperature or wiping the faces of the cuvette once a day with a strong solution of organic detergent may suffice. (The detergent causes very little increase of blank as a red fluorescence is being measured.)

A 10-mv recorder for the output of the fluorometer with the output adjusted as described in the Turner instrument manual is required.

B. EXPERIMENTAL

PROCEDURE

1. Draw distilled water through the cuvette until it has been thoroughly flushed and filled. Turn off the pump to conserve water and adjust the zero with door 1 so that the blank is near zero. Switch successively to doors 3, 10, and 30; record blanks for each door. Repeat this operation once or twice a day.

2. Suck sea water and measure the output of the fluorometer using a suitable door. Change doors if the output exceeds 9 mv or decreases below 1 mv. Calculate the chlorophyll *a* content of the water using the expression

$$\text{mg chlorophyll } a/\text{m}^3 = F_D \times R \quad \text{—1}$$

The values for F_D for doors 1, 3, 10, and 30 must be determined as described in Section C.

C. CALIBRATION

Very frequent standardization is necessary if this method is to be anything but a semiquantitative technique for detecting major changes of phytoplankton concentration. The output for a given concentration of chlorophyll (in suspension) depends on species in an (as yet) unpredictable fashion. The value for F_D can vary at least threefold for samples taken within a few miles of each other. The factor is nearly always greater near the surface than deeper in the euphotic zone and should be determined at several depths for the best work. Although the fluorescence is proportional to concentration in most circumstances (equation 1), if the concentration of chlorophyll *a* exceeds *about* 5 mg/m³ or if cells are suspended in filtered sea water (e.g. phytoplankton cultures) a power function may be found in some instruments and thus should be carefully checked.

Every time a door is changed or, for the best work with the ship underway, every 30 min, take a liter of effluent from the fluorometer and at the same time mark the chart. Analyze the effluent for chlorophyll *a* as described in IV.3.IV. Calculate the door factor F_D from the expression

$$F_D = \frac{\text{mg chlorophyll } a/\text{m}^3}{R}$$

where R is the reading (corrected for blank) at the moment the sample is taken.

The method does not distinguish between chlorophyll and phaeo-pigments and is best calibrated in chlorophyll equivalents even though some degradation products may be present in the water. The method is, essentially, an exploratory tool and discrete samples should always be taken and analyzed fully by methods IV.3.I or IV.3.IV whenever precise data are needed.

IV.4. DETERMINATION OF PARTICULATE CARBON

IV.4.1. WET OXIDATION WITH DICHROMATE

INTRODUCTION

The following method has been designed to give a rapid estimation of the amount of particulate organic material in sea water. The method involves the wet oxidation of carbon by acid dichromate and is based on the procedure described by Johnson (*J. Biol. Chem.*, 181: 707, 1949) adapted by us to spectrophotometry. The method may give higher results than the classic determination of carbon by measurement of carbon dioxide but the simplicity of the procedure allows a large number of determinations to be performed even under shipboard conditions without the use of specialized or complex equipment.

Results given by this method are in terms of glucose carbon. The true carbon content of particulate organic material would only approach this value if all the carbon were present as carbohydrates. Normally results will be high, or low, according to the nature of the organic material, but the average composition of phytoplankton and detritus is such that the true carbon content is within 10–20% of the “oxidation” value given by the present procedure. The “oxidizable carbon” is a realistic measure of the energy stored in a crop.

METHOD

A. CAPABILITIES

Range: 10–4000 mg C/m³ (using between 10- and 0.5-liter samples)

PRECISION AT THE 800 μ G LEVEL

The correct value lies in the range:

Mean of n determinations $\pm 120/n^{\frac{1}{2}}$ μ g carbon.

(Divide by the volume of seawater sample used [in liters] to get the corresponding data in mg/m³.)

B. OUTLINE OF METHOD

The particulate matter is filtered on to a glass-fiber filter. Carbon is then determined by “wet ashing” with a mixture of potassium dichromate and concentrated sulphuric acid, and measuring the decrease in extinction of the yellow dichromate solution after it has been reduced by the organic matter.

C. SPECIAL APPARATUS AND EQUIPMENT

4.5-cm Whatman GF/C glass filter papers fitted into standard Millipore filtration equipment. The filters must be freed from oxidizable material by placing them on aluminum foil (largely separated from one another) in a muffle furnace at a temperature of 450–500 C for 24 h. Great care must be taken to see that the temperature does not exceed 500 C or else undesirable sintering of the glass fibers will take place. After ignition the filters may become very slightly brittle but there

should be no distortion and the filtration properties should be unchanged. Store ignited filters carefully wrapped in aluminum foil to protect them from dust and always handle them with metal forceps.

50-ml stoppered graduated measuring cylinders. There may be a requirement for 100-ml stoppered graduated cylinders.

30-ml Pyrex glass beakers fitted with coverglasses.

For details concerning the cleaning of this and other glassware, see Section F.

D. SPECIAL REAGENTS

1. SULPHURIC ACID-DICHROMATE OXIDANT

Dissolve 4.84 g of potassium dichromate, $K_2Cr_2O_7$, in 20 ml of distilled water. Add this solution *a little at a time* to about 500 ml of concentrated (sp gr 1.82) analytical quality sulphuric acid in a 1000-ml volumetric flask. Cool the mixture to room temperature and make to volume with more concentrated acid. Store the solution in a glass-stoppered bottle, protected from dust, in which it is stable indefinitely.

2. PHOSPHORIC ACID

Use an analytical reagent grade of the 70% "syrupy" acid.

3. SODIUM SULPHATE SOLUTION

Dissolve 45 g of best quality anhydrous sodium sulphate, Na_2SO_4 in 1000 ml of distilled water.

E. EXPERIMENTAL

Note: The following describes a procedure to measure unreduced dichromate spectrophotometrically. It is convenient and precise but if a spectrophotometer is not available the entire content of the beakers (paragraph 3 *below*) can be titrated after first diluting to about 50 ml with distilled water. Use ferrous ammonium sulphate, *ca.* 0.05N, standardized against blanks and blanks with added glucose (Sect. G) using any suitable redox indicator.

PROCEDURE

1. Fit a 4.5-cm glass filter into the filter-holder and attach the equipment to a controlled source of vacuum which cannot exceed $\frac{1}{4}$ - $\frac{1}{3}$ atm (Note *a*). With full suction applied filter a suitable volume (0.5-10 liters) and finally allow the filter to be sucked dry. Break the vacuum and add 2 ml of sodium sulphate solution. Reapply suction *immediately* and suck the paper dry. Repeat once more with a further 2 ml of sodium sulphate solution (Note *b*).

2. Remove the paper with metal forceps and place it in a specially clean 30-ml beaker (Sect. F) using the forceps to flatten the paper onto the bottom of the beaker. Add 1.0 ml of phosphoric acid and 1.0 ml of water from pipettes. Mix these two additions thoroughly. Put the coverglass onto the beaker and place it in a sand-bath or block heater carefully protected from any dust (Sect. F). Heat the contents for 30 min at 100-110 C (Note *c*).

3. Add suitable volumes of sulphuric acid-dichromate oxidant and distilled water from graduated pipettes, according to the anticipated amount of carbon (Note

d). Place the coverglass over the beaker and return it to the heater for a further 60 min (Note *e*).

4. Cool the mixture and transfer the solution and glass-fiber pulp to a suitable-sized stoppered graduated cylinder (Note *d*), washing the sides of the beaker thoroughly with distilled water. Make the solution to volume and mix. Allow most of the glass fibers to settle, and cool content of the cylinders by placing them for a few minutes in a water bath at room temperature. When solutions have cooled and are partially cleared decant a suitable volume into a centrifuge tube and spin down any remaining glass fibers and particles of undigested inorganic matter by centrifugation at 2000 rpm for about 5 min. Pour the solution from the centrifuge tube into a spectrophotometer cell.

5. Measure the extinction of the blank solution (Sect. F.2) in a spectrophotometer *against the sample* (Note *f*), using light of wavelength 4400 Å and a 1-, 2-, or 10-cm-path-length cell (Note *d*). A slightly wider slit-width than normal may be required with the spectrophotometer. If the extinction exceeds 0.8 the determination must be repeated (Note *g*).

6. Correct the resulting extinction for the absorbance of trivalent chromium by the expression

$$E = 1.1E_{\text{found}}$$

Correct and report the final extinction (*E*) to the nearest 0.005. Calculate the particulate carbon in milligrams per cubic meter (mg C/m³) from the expression:

$$\text{mg C/m}^3 = \frac{E \times F \times v}{V}$$

where *V* is the volume (in liters) of sea water used, *F* is a factor determined as described in Section G and *v* is the volume (in milliliters of oxidant used (*see* Note *d*)).

NOTES

(*a*) With glass papers the suction should not exceed about one third of an atmosphere or material may be drawn through the filters.

(*b*) This washing removes much of the chloride trapped in the paper from the seawater sample. With *rapid* washings using these small measured volumes of sodium sulphate solution there is no significant disruption of cellular material and loss of carbon through the filter.

(*c*) Chloride interferes with the dichromate oxidation of carbonaceous material by reducing the chromate. The treatment with phosphoric acid volatilizes most of the chloride as hydrogen chloride and reduces the remaining halide to an acceptable level (less than about 0.1 mg of Cl⁻).

(*d*) The correct volumes of oxidant and water to be added at this stage are judged from the following table, which also indicates a suitable cell length for subsequent spectrophotometry and the final volume of solution that is required.

Anticipated carbon (μg)	Ml of oxidant	Ml of water	Cell length (cm)
Up to 300	2.00	0.8 (make to 100 ml)	10
300-700	4.00	1.6 (make to 50 ml)	2.5
700-2000	10.00	4.0 (make to 50 ml)	1

(*e*) This time is not critical but is a safe maximum for complete oxidation. There is nothing to gain by prolonging the heating unduly and the chances of contamination are increased.

(f) The *blank solution* (with a higher extinction than the *sample solution*) is placed in the spectrophotometer cell normally used for samples and the *sample solution* in the cell normally used for water or other pure reference liquids. In this manner the *difference* between sample and blank (a measure of the bleaching of the dichromate) is measured directly on the spectrophotometer working in its most sensitive range. This gives rise to more precise values than would be obtained if two comparatively large extinctions were measured separately against water and then subtracted.

(g) Not more than about 75% of the oxidant should be used up in this method or low results may occur. If the extinction exceeds about 0.8 the determination should be repeated using more oxidant.

F. DETERMINATION OF BLANK

1. CLEANING OF GLASSWARE

It is imperative that the 30-ml beakers used in this method be cleaned in hot chromic-sulphuric acid cleaning mixture and stored in a desiccator or some suitable container where dust contamination is impossible. The interior of the glassware must not be touched by hand. The heating of solutions on a water bath should be undertaken in dust-free conditions and a large sheet of glass or plastic held about 1 ft above the bath will lessen possible contamination.

2. BLANK DETERMINATIONS

With each batch of samples two blank determinations should be undertaken by carrying out the method exactly as described in Section E, paragraphs 1-4 inclusive. The amount of sulphuric acid-dichromate oxidant to use depends upon the level of carbon being determined in the samples. The extinction of blanks measured against water should be between 1 and 1.1 and should be checked. If duplicate values differ by more than 0.03 repeat the blank determinations with a further duplicate. If the agreement is satisfactory fill the spectrophotometer cell with approximately equal volumes of the two blank solutions and use this mixture as described in Section E.5 above.

G. CALIBRATION

1. STANDARD GLUCOSE SOLUTION

Dissolve 7.50 g of pure glucose and a few crystals of mercuric chloride, HgCl_2 , in water and make the volume to 100 ml with distilled water in a volumetric flask. This solution is stable if stored in a refrigerator but must be discarded if any turbidity develops.

For use dilute 10.0 ml of the concentrated solution to 1 liter with distilled water in a volumetric flask. Use this solution within a day of preparation.

$$1.00 \text{ ml} \equiv 300 \mu\text{g of carbon}$$

2. PROCEDURE

Into five clean 30-ml beakers place glass filter papers moistened with 1 ml of phosphoric acid. Heat the beakers for 30 min on the sand-bath or block heater. To two beakers add 10.0 ml of sulphuric acid-dichromate oxidant and 4.0 ml of distilled water and to the remaining three beakers add 10.0 ml of oxidant and 4.0 ml of dilute glucose solution. Continue the method exactly as described in Section E, paragraphs 3-4 inclusive. Mix the two blank solutions (the extinctions of which against water

should agree to 0.03) and use as described in Section E.5 to obtain the extinction of the three standards. Calculate the factor F from the expression:

$$F = 120/E_c$$

where E_c is the mean corrected extinction of the three standards. The value of F should be approximately 275 and need not be redetermined except for training purposes.



IV.4.II. COMBUSTION IN OXYGEN (HIGH LEVELS)

INTRODUCTION

The estimation of particulate carbon by combustion in oxygen is a more accurate method for the determination of total carbon than the method previously described (IV.4.I). However, although the measurement of oxidized products other than carbon is avoided, care must be taken not to include inorganic carbon from carbonates in any method involving combustion. The apparatus required for the determination of carbon by combustion is much more extensive than that required in the previous method, and is not particularly suitable for shipborne operations.

A number of companies now manufacture carbon-hydrogen analyzers, and when these are available to the analyst their use is generally recommended. We have employed the Coleman Model 33 Carbon-Hydrogen Analyzer which is a semi-automated instrument, generally best employed for milligram amounts of carbon. Since full working instructions are given with the purchase of this equipment, the following description deals only with the preparation of samples and the reproducibility of results, as found when applied to particulate material collected by filtration.

METHOD

A. CAPABILITIES

Range: 30-10,000 mg C/m³ (using between 10- and 1-liter samples)

PRECISION AT THE 7 MG LEVEL

The correct value lies in the range:

Mean of n determinations $\pm 110/n^{\frac{1}{2}}$ μg carbon.

B. OUTLINE OF METHOD

An amount of carbon retained on a glass filter paper is burned in a stream of oxygen. The resulting carbon dioxide is absorbed onto soda-lime-asbestos and weighed.

C. SPECIAL APPARATUS AND EQUIPMENT

Coleman Model 33 Carbon-Hydrogen Analyzer and reagents recommended by the manufacturers for its operation.

4.5 cm Whatman GF/C glass filter papers prepared as described under Section IV.4.I.C.

Semimicrobalance suitable for weighing the absorption tubes.

D. EXPERIMENTAL

PROCEDURE

1. Carry out the procedure described in IV.4.I, Section E, paragraph 1.

Note: If carbonates are believed to be present the filter paper should be held in fuming hydrochloric acid for a 0.5-1 min prior to washing the filter with sodium sulphate.

2. Using forceps, roll the glass filter paper into a loosely packed tube and

fasten it with a thread of copper wire to prevent its unrolling. Insert the sample in the combustion tube and cover with Cuprox ®.

3. Carry out the procedure as recommended by the manufacturers and determine the weight of carbon dioxide produced.

4. Determine the quantity of carbon from the expression:

$$\frac{\text{weight of carbon dioxide in mg}}{\text{volume of sea water filtered}} \times 273 \text{ } \mu\text{g/liter}$$

IV.4.III. COMBUSTION IN OXYGEN (LOW LEVELS)

INTRODUCTION

So far as we know this approach has not been used before and is not described in the literature. The use of an infrared CO₂-analyzer to complement dry combustion of particulate matter has been proposed by several workers but the use of a direct combustion in glass ampules is new and is particularly convenient in laboratories where routine soluble carbon determinations are also being undertaken.

METHOD

A. CAPABILITIES

Range: 10–200 mg C/m³ (using a 1-liter sample)

1. PRECISION AT THE 30 MG C/M³ LEVEL (USING A 1-LITER SAMPLE)

The correct value lies in the range:

Mean of n determinations $\pm 4/n^3$ mg C/m³.

2. LIMIT OF DETECTION

This will depend on the volume of water filtered. With a 3-liter sample the method will detect 2–3 mg C/m³.

B. OUTLINE OF METHOD

Particulate matter is filtered onto a glass-fiber filter which is put into a glass ampule and dried. The ampule is filled with oxygen, sealed, and heated to 500 C for 4 hr to burn off all organic matter. The resulting carbon dioxide is analyzed as described in III.4 except that 1-inch rather than 7-inch cells are used in the non-dispersive infrared gas analyzer.

C. SPECIAL APPARATUS AND EQUIPMENT

See IV.2 and III.4. Most of the equipment is needed except for hypodermic syringes and the measure for persulphate. Use 25-mm glass-fiber filters previously ignited for 2 hr in air at 450 C and stored in ignited aluminum foil.

D. SPECIAL REAGENTS

None.

E. EXPERIMENTAL

PROCEDURE

1. Filter a suitable volume of water (Note *a*) through a 25-mm preignited glass-fiber filter. Wash the sides of the funnel with a little filtered sea water. Remove the filter with blunt-ended metal forceps (Note *b*) and hold it for a few seconds in the mouth of a bottle of concentrated hydrochloric acid so that the filter becomes bathed in the acid vapours (Note *c*).

2. Return the filter to the filter funnel assembly and, with the aid of a second

pair of forceps (Note *b*), fold the filter into a cylinder, and drop it into a 10-ml ampule (Note *d*).

3. Place the ampule in an oven at 60 C, and dry overnight (Note *e*).

4. Place the ampule in the degassing train as in Method III.4.F.2 except substitute cylinder oxygen gas for nitrogen gas. Pass the pure oxygen at 200 ml/min for 2 min and seal the ampule as described in III.4.F.4.

5. Wrap each ampule in a piece of aluminum foil and place in a muffle at 500 C for 4 hr (Notes *f* and *g*).

6. Remove the ampules from the muffle, cool to room temperature, and continue the determination as described in III.4.F.6–8 except use 1-inch instead of 7-inch cells in the analyzer (Note *h*). Blank and standardization procedures will be found in Sections F and G.

NOTES

(*a*) Normally 1 liter is sufficient. For deep ocean water up to 3 liters may be needed. For eutrophic surface waters with a phytoplankton bloom, 500 ml or less may be necessary, or method IV.4.2 may be used.

(*b*) Flame the ends of the forceps in a *nonluminous* flame to clean them before use.

(*c*) A brief exposure to acid fumes is necessary to remove inorganic carbonates. This precaution may be unnecessary with samples from many areas but this is left to the discretion of the analyst.

(*d*) The ampules must be marked serially by scratching with a diamond pen: other markings will be lost upon ignition.

(*e*) Every trace of moisture has to be removed or the steam pressure generated when ampules are ignited will break the glass. Protect the ampules from dust and dirt by placing them under a well ventilated cover.

(*f*) Each ampule should be individually wrapped as a precaution against one's exploding. Unless the ampules are sheltered from each other the explosion of one ampule will start a chain reaction resulting in the breakage of every ampule in the muffle. The temperature should be carefully controlled: 500 C is as high as can generally be used with KIMAX or Pyrex ampules.

(*g*) The amount of oxygen in an ampule is sufficient for the combustion of several milligrams of organic matter and so is present in a large excess. At 500 C and pressures exceeding 2 atm, ignition is completed rapidly; 4 hr is more than sufficient time for the reaction.

(*h*) It is convenient to house these 1-inch cells in series with the 7-inch cells used in the determination of dissolved organic matter. The long cells should be flushed with pure nitrogen and stoppered before using the small cells.

F. DETERMINATION OF BLANKS

This is done on a glass-fiber filter taken through the method and should generally be very small, i.e., only 1 or 2 μg , so that the correction is only necessary with quantities of carbon less than about 20 mg/m^3 . A blank should always be made, however, as a precaution to detect unexpected gross contaminations. This "apparatus" blank does not give an adequate blank for possible contamination introduced during the sampling and the handling of samples. Such a blank, which would also include adsorption onto filters of "dissolved" organic matter, is very difficult to obtain. One method is to filter progressively smaller volumes (2, 1, 0.5 liters), determine the carbon in each sample, and extrapolate back to zero sample volume, having first corrected cell values for the "apparatus" blank. Such a procedure is

scarcely justified except when analyzing deep ocean samples and the subject is still one of controversy amongst analysts.

G. CALIBRATION

1. *Standard Urea Solution*

Dissolve 0.500 g of dry urea in 100 ml of distilled water. Store frozen in a glass bottle when not in use.

$$0.100 \text{ ml} = 100 \mu\text{g C}$$

Note: We have experienced considerable difficulty in finding a suitable standard for this method. Although results on particulate matter seem reasonable the response from many standards has been erratic and low. We suppose this is caused by the decomposition of the standard on drying or, more likely, by the "dusting" when the water is removed which causes solid to be blown from the ampule when it is being filled with oxygen.

Use the sensitivity setting on the infrared analyzer found to give full scale deflection with 6.0 ml of the standard used in Method III.4 with 7-inch cells. This should give full scale deflection with about 200 $\mu\text{g C}$ using 1-inch cells.

Prepare standards, in duplicate, containing 0.05, 0.10, and 0.20 ml of standard introduced by a micropipette onto a glass-fiber filter in an ampule. This corresponds to 50, 100, and 200 $\mu\text{g C}$. Carry out the determination exactly as described in Section E.2-6 above measuring the peak-heights or areas. Plot the standardization curve and use in an analogous way to that described in III.4.H. A calibration curve should be run with each batch of samples.



IV.5. DETERMINATION OF PARTICULATE PHOSPHORUS

INTRODUCTION

This method is a simple modification of the technique given in Part II.3 applied to concentrates of particulate matter obtained as described in Part IV.2.

METHOD

A. CAPABILITIES

Range: 0.1–15 mg P/m³ (using between 3- and 0.5-liter samples)

PRECISION AT THE 2 μ G LEVEL

The correct value lies in the range:

Mean of n determinations $\pm 0.07/n^3$ μ g phosphorus.

(Divide by the volume of seawater sample used [in liters] to get the corresponding data in mg/m³.)

B. OUTLINE OF METHOD

The suspension obtained as described in Part IV.2 is treated with perchloric acid, evaporated, and the residue is heated to oxidize organic matter and liberate phosphorus as inorganic phosphate. The phosphate is determined by the procedure given in Part II.2.I.

C. SPECIAL APPARATUS AND EQUIPMENT

See Part II.3, Section C. In addition there is a requirement for 50-ml glass-stoppered measuring cylinders.

D. SPECIAL REAGENTS

See Part II.3, Section E, omitting the potassium iodide solution.

E. EXPERIMENTAL

Note: In summer months with coastal water containing a heavy crop of phytoplankton 500 ml of sample will be sufficient but for much of the year and in the open 1–3 liters should be filtered.

PROCEDURE

1. Add 1.0 ml of perchloric and 4–5 drops of concentrated nitric acid to the Erlenmeyer flask containing the particulate matter and magnesium carbonate obtained as described in IV.2.

2. Evaporate the solution until dense white fumes of perchloric acid are evolved with no brown fumes from the nitric acid. Continue heating until the liquid in the flask is nearly gone but do not bake the flask dry.

3. Cool the flask and add a carborundum granule and 25 ml of distilled water. Boil the solution vigorously for 30 min to hydrolyze any polyphosphate formed by the fuming perchloric acid.

4. Add 5 ml of dilute ammonia solution and boil until little or no smell of ammonia remains. Add 20 ml of dilution (not distilled) water to dissolve any precipitate.

5. Cool the flask and pour the contents into the 50-ml cylinder, rinse the flask, and make the volume to 50 ml with distilled water.

6. Add 5 ± 0.5 ml of mixed reagent from a 10-ml measuring cylinder and mix at once. Continue as described in Part II.3,F.7.

7. Correct the extinction by that of a blank obtained as described in Section F below and calculate the amount of particulate phosphorus from the expression:

$$\text{mg P/m}^3 = \frac{F \times \text{corrected extinction}}{V}$$

where V is the volume of sample used (in liters) and F is a factor obtained as described in Section G.

F. DETERMINATION OF BLANK

With each batch of samples carry out two blank determinations by using the method described in Section E with a "blank" precipitate obtained as described in IV.2,F.

G. CALIBRATION

Use the standard phosphate specified in Part II.3. Add 5.0 ml of this standard to each of three flasks and reserve two flasks for blank determinations. Continue the determinations as described in Section E.1-6 above.

Calculate the factor F from the expression:

$$F = \frac{4.65}{E_s - E_b}$$

where E_s is the mean extinction of the three standards and E_b the mean extinction of the two blanks.

IV.6. DETERMINATION OF PARTICULATE NITROGEN

IV.6.I. COMBUSTION METHOD (HIGH LEVELS)

INTRODUCTION

When it is possible to obtain a few milligrams of dried particulate material (e.g. from eutrophic waters or by netting the larger plankters), nitrogen analysis is best performed by the classical micro-Dumas method. Several pieces of semiautomated equipment for this procedure are available commercially. These are to be preferred to most apparatus built in the laboratory. All stopcock and furnace manipulations are automatic, thus eliminating variability due to operator technique. In our own laboratory we have employed the Model 29 Coleman Nitrogen Analyzer. Since full working instructions are given with the purchase of this equipment, the following description deals only with the preparation of samples and the reproducibility of results, as found when applied to particulate material collected by filtration.

METHOD

A. CAPABILITIES

Range: 5–1000 mg N/m³ (using between 10- and 1-liter samples)

1. PRECISION AT THE 500 MG/M³ LEVEL

The correct value lies in the range:

$$\text{Mean of } n \text{ determinations } \pm 20/n^{1/2} \text{ mg N/m}^3.$$

B. OUTLINE OF METHOD

Organically combined nitrogen is liberated as gaseous nitrogen by heating and the quantity of gas is measured manometrically after removing the carbon dioxide carrier gas in a caustic absorption chamber.

C. SPECIAL APPARATUS AND EQUIPMENT

Coleman Model 29 Nitrogen Analyzer and reagents recommended by the manufacturers for its operation.

4.5-cm Whatman GF/C glass filter papers prepared as described under Section IV.4.I.C.

Semimicrobalance suitable for weighing the absorption tubes.

D. EXPERIMENTAL

PROCEDURE

1. Carry out the procedure as described in IV.4.I, Section E, paragraph 1.

2. Using forceps, roll the glass filter paper into a loosely packed tube, and fasten with a thread of copper wire to prevent its unrolling. Insert the sample into the combustion tube and cover with Cuprox ®.

3. Carry out the procedure as recommended by the manufacturers and determine the value of nitrogen gas produced (corrected for blank, barometric pressure, and sample temperature as described by the manufacturers).

4. Determine the quantity (mg N/m³) of nitrogen from the expression:

$$\frac{\text{Volume of nitrogen } (\mu\text{l corrected})}{\text{Volume of sea water filtered (l)}} \times 1.25$$

IV.6.II. KJELDAHL METHOD WITH NINHYDRIN FINISH (LOW LEVELS)

INTRODUCTION

This determination of particulate nitrogen by reaction with ninhydrin is a modification of the previous method using Nessler's reagent with a more sensitive colorimetric technique based on a method by S. Jacobs (*Analyst*, 87: 53, 1962). The method enables the particulate nitrogen content of deep ocean samples to be determined using 1 liter or less of sample. Details have recently been published by Holm-Hansen (*Limnol. Oceanog.* 13: 175, 1968).

METHOD

A. CAPABILITIES

Range: 0.25–150 mg N/m³ (using between 2- and 0.5-liter samples)

PRECISION AT THE 6.0 μG LEVEL

The correct value lies in the range:

Mean of n determinations $\pm 0.6/n^{\frac{1}{2}}$ μg nitrogen.

(Divide by the volume of sample in liters to get the corresponding data in mg/m^3 .)

B. OUTLINE OF METHOD

The nitrogen in the particulate matter is converted to ammonia by a Kjeldahl treatment with sulphuric acid. The resulting ammonia is determined absorptometrically by complex formation with ninhydrin–hydrindantin, without prior distillation.

C. SPECIAL APPARATUS AND EQUIPMENT

Two 18 \times 150-mm Pyrex lipless thick-glass test tubes are required for each determination. The tubes must be given an initial cleaning by immersing them in near-boiling concentrated sulphuric acid for several hours and then washing them with distilled water. If they are rinsed thoroughly with distilled water before and after use and stored with the mouth of each tube tightly sealed with "Parafilm" sheeting or aluminum foil, re-cleaning is necessary at very infrequent intervals only when contamination is suspected.

An ice or cold-water bath fitted with a rack to hold the above tubes.

A boiling-water bath with rack to hold the above tubes. Also a room-temperature water bath to cool tubes after heating.

A micro-Kjeldhal rack and vent to take the above tubes and give suitable controlled heating. Several such units are available commercially.

D. SPECIAL REAGENTS

1. DIGESTION MIXTURE

Dissolve 0.2 g of analytical reagent quality selenium dioxide, SeO_2 , in about 200ml of distilled water. Add 110 ml of analytical reagent quality concentrated sulphuric acid (sp gr 1.84). Cool the mixture to room temperature and make the

volume to 1 liter with distilled water. Store in a tightly stoppered glass bottle and discard only if contamination is suspected.

2. SODIUM HYDROXIDE SOLUTION

Dissolve 40.0 g of analytical reagent quality sodium hydroxide in 1000 ml of distilled water. Store this solution in a well-stoppered polyethylene bottle and discard only if contamination is suspected.

3. ACETATE BUFFER

Dissolve 136 g of reagent grade sodium acetate trihydrate ($\text{NaC}_2\text{H}_3\text{O}_2 \cdot 3\text{H}_2\text{O}$) in 100 ml distilled water. Add 25 ml glacial acetic acid; dilute to 250 ml with distilled water. Store the solution in a glass or polyethylene bottle.

4. NINHYDRIN-HYDRINDANTIN REAGENT

Dissolve 0.50 g ninhydrin and 0.075 g hydrindantin in 20 ml of methylcellosolve (ethylene glycol monomethyl ether). Add 5.0 ml of acetate buffer. Stir briefly. Unless the reagent is to be used within 30 min, bubble nitrogen gas through the solution while the flask is kept at room temperature and in the dark. This solution is stable for only about 12 hr.

5. ANTIBUMPING GRANULES

We have found a few fragments of Hengar granules or Fisher's "Boileasers" are satisfactory provided they are pretreated by heating them in boiling or near-boiling concentrated sulphuric acid for 2-3 hr. After the acid treatment the granules should be boiled with 2 or 3 changes of water, rinsed thoroughly, and oven dried. The latter treatment is essential if their antibumping properties are to be restored.

6. PHENOLPHTHALEIN INDICATOR

Dissolve about 0.2 g of phenolphthalein in 50 ml of 80% ethanol.

7. ETHANOL-WATER MIXTURE

Mix together 250 ml of 95% ethanol and 250 ml of distilled water. Store in a well-stoppered glass bottle. The mixture is stable indefinitely.

E. EXPERIMENTAL

PROCEDURE

The sensitivity of this method is such that it is rarely necessary to use more than 1 liter of sample even in deep ocean water. For most coastal samples only 0.5 liter should be filtered. Filter samples on a 25-mm Whatman GF/C glass filter and place this filter, without folding it, along the side of the test tube, pushed down until it just touches the bottom.

1. Add a small fragment of one "Boileaser" or Hengar granule and then 1.0 ml of digestion mixture from a 1-ml "blow out" pipette. Heat the tube on the Kjeldahl heating rack until all the water is removed and digest the residue for a further 60 min at about 250 C to complete the reaction (Note *a*).

2. Cool the tube and add exactly 3.0 ml distilled water. Place in hot water to dissolve most of precipitate (Note *b*).

3. Cool the tubes in an ice bath, add one drop of phenolphthalein indicator,

and add 3.5 ml of sodium hydroxide solution slowly from a 5.0 ml graduated pipette, while the tube is agitated. Cool the solutions again and add more sodium hydroxide solution carefully, *dropwise*, from a 1.0 ml graduated pipette until the solution becomes just pink. Mix well after each addition, using a "tube buzzer." There should be a slight precipitate in each tube, the quantities of which may not, however, be quite identical. Cover the tubes with metal or plastic foil (Note *c*).

4. Centrifuge the contents of each tube for about 5 min at 2000 rpm. Draw off exactly 3.0 ml of the supernatant liquid with a 5-ml graduated pipette, taking care not to disturb the precipitate, and transfer this aliquot to a clean dry 18 × 150-mm test tube. Add 2.0 ml of ninhydrin-hydrindantin reagent and mix the solutions immediately with a tube buzzer (Note *d*).

5. Heat the tubes on a boiling water bath for 20 min. Remove the tubes from the water bath.

6. Cool the solution rapidly to room temperature in a water bath (Note *e*). Pipette 1.0 ml of the coloured solution into a clean dry test tube into which has already been added 5.0 ml of ethanol-water mixture.

7. Measure the extinction of the solution (Note *e*) in a 1-cm cell using light with a wavelength of 5700 Å (Note *f*). Correct the sample extinction for that of a blank determination, carried out as described in Section F. Calculate the concentration of particulate nitrogen in milligrams per cubic meter (mg N/m³) from the expression:

$$\text{mg N/m}^3 = \frac{\text{corrected extinction} \times F}{V}$$

where *F* is a factor determined as described in Section G, below, and *V* is the volume (in liters) of sea water used.

NOTES

(*a*) About 30 min is required to remove all the water. Any carbon char should be oxidized in a further ½ hour. A temperature of about 250 C is suitable for the oxidation. Sulphuric acid vapour should not be allowed to escape from the tube in any appreciable amounts. The best temperature is reached when the acid refluxes down the sides of the tube from a ring of condensed acid about 1 inch up from the bottom of the tube and above the level of the glass filter.

(*b*) There should be no significant loss of liquid by evaporation at this stage. The volume of added water should be exactly 3 ml as the final volume of solution for absorptiometry depends on this addition.

(*c*) If the solution is kept cool at this stage and the tube mouth is covered with foil, especially during centrifugation, there is little or no loss of ammonia, despite the fact that the solution is alkaline.

(*d*) Formation of the colour complex with ammonia is dependent upon the presence of both oxidized and reduced ninhydrin. The latter is easily oxidized by air. It is therefore necessary either to store the deoxygenated reagent under nitrogen in the dark, or to make the reagent up freshly each day. The reagent should be a darkish-red colour due to the reduced ninhydrin; upon oxidation the reagent mixture becomes progressively straw-coloured. When the reagent is yellowish, there is little or no colour formation with ammonia. If the reagent turns yellow within minutes after dissolving in methylcellosolve and acetate buffer, one must test the methylcellosolve for presence of peroxides. This can be done by adding 2.0 ml of the solvent to 1.0 ml of freshly prepared 4% aqueous KI. The methylcellosolve is satisfactory if the resulting solution

is colourless or only a *light* straw-yellow. If a reddish colour develops, either the methylcellosolve has to be distilled or a new bottle has to be obtained.

(e) The solution is stable for many hours but should not be chilled below room temperature or solids may separate resulting in turbidity and a loss of extinction on re-centrifugation.

(f) The dilution procedure described here is suitable for quantities of nitrogen varying between about 5 and 50 mg N/m³ using a 1-liter sample. If concentrations are thought to be less than about 6 mg N/m³ on a 1-liter sample the extinction of the solution obtained in Section E.5 above can be measured directly. After correcting for an *undiluted* blank the resulting extinction is multiplied by 0.165 before being used in the expression in Section E.7. If extinction values exceed about 1.1 the solutions may be diluted by taking 1.0 ml of stock and 10 ml of ethanol-water mixture and making a corresponding dilution for the blanks. In this case the corrected extinctions should be multiplied by 1.83 before used in the expression in Section E.7.

F. DETERMINATION OF BLANK

The precautions against contamination by ammonia and ammonium salts already described in Part II.8 apply equally well to the present technique.

The amounts of reagents used here are comparatively small so no trouble should normally be encountered if good quality chemicals and distilled water are employed. If a blank extinction much exceeds 0.1 the sulphuric acid may be suspect and another bottle of this reagent should be tested.

Carry out the method as described in Section E.1–5 above, using a 25-mm glass-fiber filter. If small amounts of nitrogen are being determined do not dilute the blanks (*refer to Note f*); otherwise continue as in Section E.6–7 finding the blank extinction as the mean of two such determinations carried out with *each batch* of samples.

G. CALIBRATION

1. STANDARD NITROGEN SOLUTION

Dissolve 1.18 g of dry analytical reagent quality ammonium sulphate in 500 ml of water in a measuring flask. Store in a well-stoppered glass bottle with a few drops of chloroform as a preservative. The solution is then stable for many months.

Dilute 10.0 ml to 100 ml in a measuring flask for use.

$$1 \text{ ml} \equiv 50 \mu\text{g N}$$

Add 1.00 ml of nitrogen standard to a 18 × 150-mm test tube containing a glass filter and carry out the method on three such standards exactly as described above in Section E.1–7, correcting the extinction by the mean extinction of two blank determinations undertaken in the same manner as the standards except for the omission of the standard nitrogen solution. Calculate the factor *F* from the expression:

$$F = \frac{50}{\text{corrected extinction}}$$

F should have a value of about 50 and should be determined with each batch of samples being analysed.

IV.7. DETERMINATION OF PARTICULATE LIPID

INTRODUCTION

The method followed in this procedure is an adaptation of the technique outlined by Mukerjee (*Analyt. Chem.*, 28: 870, 1956). The method is highly sensitive to the presence of fatty acids and has been used in preference to ether extraction techniques because of its specificity and its simplicity of operation.

Results are a function of the number of carboxylic acid or similar weak-acid groups present in the lipid material of particulate organic matter. The sensitivity is very similar, on a functional group basis, for all fatty acids with more than about 12 carbon atoms. The method does not differentiate between free acids and the corresponding esters (glycerides) or between saturated and unsaturated compounds. The procedure will generally give lower results than those to be expected from ether extraction experiments. The average lipid composition of phytoplankton is such that results expressed in terms of a stearic acid standard will be a reasonable measure of the lipid in most species.

METHOD

A. CAPABILITIES

Range: 2–1000 mg lipid/m³ (using between 10- and 0.5-liter samples)

PRECISION AT THE 40 μ G LEVEL

The correct value lies in the range:

Mean of n determinations $\pm 10/n^{1/2}$ μ g stearic acid.

(Divide by the volume [in liters] of the seawater sample to get the corresponding data in mg/m³.)

B. OUTLINE OF METHOD

The lipid material in the concentrated particulate matter from a sample of sea water is extracted by alcoholic potassium hydroxide. The resulting soap is treated with the cationic dye, pinacyanol, and the coloured complex thus formed is extracted into bromobenzene. The extinction of this blue extract is measured in a 1-cm cell.

C. SPECIAL APPARATUS AND EQUIPMENT

The 15-ml graduated stoppered centrifuge tubes used for this method should be fitted with air condensers (15 cm long) in the ground-glass mouth of each tube. (A 14/35 male standard glass joint makes an excellent condenser for this method.) The tubes and condensers should be cleaned initially with hot chromic-sulphuric acid and rinsed with distilled water. Subsequent cleaning with reagent quality acetone should prove adequate. This method is very sensitive and care must be taken not to touch the interior surfaces of any equipment.

60-ml pear-shaped separatory funnels covered with aluminum foil (held in place with black tape) to make them lighttight. The stop cocks must *not* be lubricated with any form of grease and should be ground into place with a little fine

emery and water to ensure a snug fit. The interior of the funnels should be soaked with acetone before use to remove all grease.

D. SPECIAL REAGENTS

1. ALCOHOLIC POTASSIUM HYDROXIDE SOLUTION

Dissolve 20 g of analytical reagent quality potassium hydroxide in 50 ml of distilled water and add 50 ml of reagent grade 95% ethyl alcohol.

2. BROMOBENZENE

Reagent grade monobromobenzene has been found to be satisfactory.

3. BORATE BUFFER

Dissolve 50 g of analytical reagent quality boric acid, H_3BO_3 , and 8.8 g of analytical reagent quality (85%) potassium hydroxide in 2000 ml of water. Keep the solution in a well-stoppered glass bottle to prevent carbonation.

4. PINACYANOL REAGENT

Dissolve 0.016 g of pinacyanol in exactly 500 ml of buffer solution, dilute to 2000 ml with distilled water, and filter. Keep this solution in the dark in a glass bottle. The solution should be renewed every 2–3 weeks and should have a pH in the range 8.4–8.6.

E. EXPERIMENTAL

PROCEDURE

1. Add 1.0 ml of alcoholic potassium hydroxide and fit the 15-cm air condenser into the centrifuge tube containing the precipitate of magnesium carbonate and particulate matter obtained as described in Part IV.2. Mix by shaking and transfer the centrifuge tube to a sand-bath or block heater. Warm for 30 min at about 100 C so that alcohol is refluxing part way up the condenser.

2. Remove the tube from the heater and allow it to cool to room temperature. Remove the condenser, make the volume of liquid inside the tube to exactly 10.0 ml with distilled water, and mix the contents of the tube with a tube buzzer. Centrifuge the solution and take a 1.00-ml aliquot of the supernatant liquid and add it to a 60-ml separatory funnel containing 40 ml of pinacyanol reagent (Note *a*). Allow the solution to stand for 5 min (Notes *b* and *c*).

3. Add exactly 5.0 ml of monobromobenzene from a burette and shake the contents of the funnel vigorously for a full minute. Allow the layers to separate for 20 min (Note *d*).

4. Withdraw sufficient organic phase from the bottom of the funnel to fill a 1-cm spectrophotometer cell and place the cell immediately into the spectrophotometer for reading or else store the cell in a lighttight box (Note *b*).

5. Measure the extinction of the solution against water in a spectrophotometer using light of 6200 Å wavelength. Correct the extinction by a blank determination carried out as described in Section F below, and calculate the amount of lipid in the particulate form from the expression:

$$\text{mg lipids/m}^3 \text{ (as stearic acid)} = \frac{\text{corrected extinction} \times F}{V}$$

where F is a factor determined as described in Section G and V is the volume of seawater sample in liters.

NOTES

(a) The amount of alkali needed for hydrolysis is too much for the subsequent colour reaction, hence a one-tenth aliquot is used at this stage. Its use is feasible because of the great sensitivity of the method.

(b) The lipid-dye complex is photosensitive in both aqueous and organic phase and for this reason the times given in this method and the precautions to exclude light should be carefully observed. The intervals have been arranged to allow for the manipulation of 10–12 determinations at one time. The effect of temperature on the method is not great but the temperature of samples and standards should be kept mutually to within a few degrees in the range 18–25 C.

(c) The effect of pH is important. If the pH is too great the blank of extracted colour not corresponding to the presence of lipids becomes undesirably large. If the pH is too low the sensitivity decreases markedly. The pH should lie in the range 8.3–8.9, preferably near 8.7, and not vary by more than 0.1 unit between samples and the corresponding standards and blanks.

(d) If the organic phase is turbid at this stage the organic layer should still be run into the spectrophotometer cell. The solution will clear after being allowed to stand for a further period in the dark.

F. DETERMINATION OF BLANK

A duplicate blank determination should be carried out with each batch of samples and the mean of the two blank extinctions (which should not exceed about 0.25 and which should be within 0.03 units of each other) is used to correct each sample extinction (Section E.5).

Pipette 1.0 ml of alcoholic potassium hydroxide solution into a centrifuge tube containing a "blank" precipitate of magnesium carbonate, obtained as described in Part III.2, and continue the determination exactly as described in Section E.

G. CALIBRATION

1. STANDARD STEARIC ACID SOLUTION

Dissolve 0.075 g of pure stearic acid in 250 ml of 95% ethyl alcohol.

$$1.00 \text{ ml} \equiv 300 \mu\text{g stearic acid}$$

Store in a well-stoppered glass bottle. The solution is stable indefinitely.

2. PROCEDURE

Add 1.00 ml of stearic acid standard to a clean dry 15-ml centrifuge tube. Evaporate the solution carefully to dryness or near-dryness. Add 1.0 ml of alcoholic potassium hydroxide solution to this residue and add another 1.0 ml to another centrifuge tube to act as a blank. On the standard and blank carry out the procedure exactly as described in Section E. Determine three extinctions from the standard solution, using three separate 1.00-ml aliquots (Sect. E, paragraph 2) and similarly find two blank extinctions from two 1.00-ml blank aliquots.

Calculate a factor F from the expression:

$$F = \frac{300}{E_s - E_b}$$

where E_s is the mean extinction of the three standards and E_b the mean extinction of the two blanks. The value F should be between 300 and 500 and should be determined at fairly frequent intervals as it may change slightly with the age of the borate buffer.

IV.8. DETERMINATION OF PARTICULATE CARBOHYDRATE

INTRODUCTION

The method followed in this determination is based on the anthrone reaction as modified by Hewitt (*Nature*, 182: 246, 1958). The choice of anthrone for the determination of carbohydrates in particulate organic material has been made on the basis of its simplicity of operation and sensitivity. The *N*-ethylcarbazole reaction, as modified by Zein-Elden and May (*Analyt. Chem.*, 30: 1935, 1958), has a greater sensitivity but its operation requires more skill.

In the present method, all hexoses (in the form of either mono- or polysaccharides) are expressed as an equivalent amount of glucose. Methylpentoses are also reported, quantitatively, as an equivalent weight of glucose. Pentoses (monomers or polymers) and hexuronides are recorded as only a fraction of the equivalent weight of hexose. Hexosamines (e.g. chitin) and mannitol are not measured at all. A *qualitative* indication of the presence of much pentose or hexuronide may be obtained by spectrophotometry.

METHOD

A. CAPABILITIES

Range: 2–4000 mg carbohydrate/m³ (using between 10- and 0.5-liter samples)

PRECISION AT THE 500 μ G LEVEL

The correct value lies in the range:

$$\text{Mean of } n \text{ determinations } \pm 54/n^{\frac{1}{2}} \mu\text{g glucose.}$$

(Divide by the volume [in liters] of the seawater sample to get the corresponding data in mg/m³.)

B. OUTLINE OF METHOD

The carbohydrate material in the concentrated particulate matter from a sample of sea water is allowed to react with a solution of anthrone in sulphuric acid. The extinction of the resulting blue solution is measured in a 1-cm cell.

C. SPECIAL APPARATUS AND EQUIPMENT

15-ml graduated stoppered centrifuge tubes.

20-ml Pyrex test tubes.

This glassware must be given a preliminary cleaning in hot chromic-sulphuric acid, rinsed thoroughly in distilled water after this cleaning (and after each determination) and stored in a dustproof container.

D. SPECIAL REAGENTS

1. ANTHRONE REAGENT

Add 100 ml of concentrated analytical reagent quality concentrated sulphuric acid, (sp gr 1.82) to 0.20 g of recrystallized anthrone (9, 10-dihydro-9-ketoanthracene) dissolved in a mixture of 8.0 ml of ethyl alcohol and 30 ml of distilled water.

This reagent should be kept cold in a dark glass-stoppered bottle and should be renewed at least once a week. Packets containing exactly 0.20-g amounts should be taken on cruises lasting more than a few days.

2. SULPHURIC REAGENT SOLUTION

Prepare exactly as described above for the anthrone reagent but omit the anthrone. The solution is stable indefinitely.

E. EXPERIMENTAL

PROCEDURE

1. Add distilled water to the centrifuge tube containing the precipitate of magnesium carbonate and particulate matter, obtained as described in Part IV.2, until the volume is exactly 10 ml. Suspend the precipitate by vigorously agitating the tube with a tube buzzer (Note *a*).

2. Pipette 1.00 ml of the suspension, before any settling can take place, into a 20-ml Pyrex test tube. Add 10.0 ml of anthrone reagent from a pipette and mix the cells into the reagent with the buzzer or a clean glass rod. (Drain but do *not* rinse the rod.) Place the tube into a water bath or block heater at 100 C for a suitable period (Note *b*).

3. Cool the mixture rapidly by placing the tube immediately under running cold water (Note *b*) and measure the extinction in a spectrophotometer, against water, using a 1-cm fused-glass cell and light of wavelength 6200 Å.

4. Correct the resulting extinction by a reagent blank (*see* Sect. F) and finally by a pigment blank if this is necessary (*also* Sect. F). Report extinction values and corrected extinction values to the nearest 0.001 in the range 0.00–0.4 and to the nearest 0.005 for extinction values exceeding about 0.4. Calculate the particulate carbohydrate from the expression:

$$\text{mg glucose/m}^3 = \frac{\text{corrected extinction} \times F}{V}$$

where V is the volume (in liters) of sea water used and F is a factor determined as described in Section G. If a *qualitative* indication of the relative amounts of hexoses, pentoses and hexuronides is desired this may be obtained by making observations of the sample extinction (paragraph 3 *above*) at 5500 and 6500 Å as well as at 6200 Å (Note *c*).

NOTES

(*a*) If the volume of sea water filtered has been misjudged the colour development can be repeated, after recentrifuging the precipitate, by making the volume to less than 10 ml. In the event of there being too much sample the precipitate can be dispersed in a volume greater than 10 ml before taking the 1.00-ml aliquot. In all cases, however, a 1.00-ml aliquot must be used as the amount of water introduced at this stage is critical. If the precipitate has to be recentrifuged there may be some loss of soluble carbohydrate in the supernatant water. The result is likely to be slightly low and the method should be repeated, using a larger volume of sample, for the best results. When concentrations of particulate carbohydrate are low it may be more convenient to filter samples through a 25-mm glass-fiber filter which is sucked dry and put in the bottom of the test tube with 1.0 ml of added distilled water. The anthrone reaction is then carried out

with 10 ml of reagent in the presence of the filter which is centrifuged to the bottom of the tube before making spectrophotometric methods.

(b) The time of heating is fairly critical. About 2 min are required to bring samples to temperature on a water bath and a further 5 ± 1 min heating then results in maximum colour development. When a block heater is used, the preliminary heating period may have to be increased somewhat and the time for maximum colour formation should be determined experimentally with the equipment concerned. On removal from the heater the samples should be cooled at once or some decrease in colour may occur.

(c) At a wavelength of 6200 Å all hexoses (aldoses and ketoses) and methylpentoses give approximately the same extinction as an equivalent weight of glucose. Pentoses give considerably less colour but their absorption peak is the same at 6500 Å as at 6200 Å. The presence of large amounts of pentose, in relation to hexose, is therefore indicated if the extinction at 6500 Å is greater than 80% of the reading at 6200 Å. Similarly the presence of large amounts of hexuronides, in relation to hexose, is indicated when the extinction at 5500 Å exceeds 60% of the reading at 6200 Å.

F. DETERMINATION OF BLANK

1. REAGENT BLANK

With each batch of samples a blank determination should be undertaken by carrying out the method exactly as described in Section E on a "blank" of magnesium carbonate obtained as described in Part III.2. The blank extinction should not exceed about 0.1.

2. PIGMENT BLANK

This correction is generally so small that it may be neglected; but for the most precise work, with large amounts of living phytoplankton present, take a further 1.0-ml aliquot of the suspended precipitate (Sect. E, paragraph 2) and carry out the analysis exactly as described in Section E except use the sulphuric reagent solution instead of the anthrone reagent. Measure the resulting extinction against distilled water and then measure the extinction of distilled water in the sample cell against the water in the reference cell. Correct the pigment blank for any "cell-to-cell" blank obtained with water in both spectrophotometer cells, and subtract the resulting corrected pigment extinction from the sample extinction values.

G. CALIBRATION

1. STANDARD GLUCOSE SOLUTION

Dissolve 1.00 g pure glucose in water and make the volume to 100 ml with distilled water in a volumetric flask. The solution is stable for a few weeks if stored in a refrigerator at 1–5 C. Discard it if any turbidity develops.

For use dilute 10.0 ml of the concentrated solution to 1000 ml with distilled water in a volumetric flask. Use this solution within a day of preparation.

$$1.00 \text{ ml} \equiv 100 \mu\text{g glucose}$$

2. PROCEDURE

To five 20-ml test tubes add magnesium carbonate by putting 2 ml of magnesium carbonate suspension (Part III.2, Sect. E.2) in the test tubes, centrifuging them, and decanting off the supernatant water. Introduce 1.0 ml of distilled water to each of two tubes and 1.00 ml of dilute glucose standard to each of the remaining

three. Add 10 ml of anthrone reagent to all tubes and continue as described in Section E, paragraphs 2 and 3. Find the mean of the three standard extinction values E_s and the mean of the two blank determinations E_b , and calculate a factor F from the expression:

$$F = \frac{1000}{E_s - E_b}$$

The value of F should be approximately 2000 and should be determined at least once with each new batch of anthrone reagent.

ADDENDUM TO IV.8. DETERMINATION OF "CRUDE FIBER"

INTRODUCTION

A measure of the proportion of "crude fiber" in the particulate carbohydrates may also be obtained by use of the anthrone reaction. Crude fiber as determined in agricultural products is not a chemical entity but consists of the acid- and alkali-insoluble carbohydrates and lignin obtained under standardized reaction conditions. In determining microquantities of crude fiber by use of the anthrone reaction the value obtained is predominately a measure of the amount of cellulose and similar polysaccharides which may have little direct food value.

METHOD

A. SPECIAL REAGENTS

1. EXTRACTING ACID FOR CRUDE FIBER DETERMINATION

Dilute 9.0 ml of concentrated analytical reagent quality concentrated sulphuric acid (sp gr 1.82) to 1000 ml with distilled water.

2. EXTRACTING ALKALI FOR CRUDE FIBER DETERMINATION

Dissolve 12.5 g of analytical reagent quality sodium hydroxide in 1000 ml of distilled water. Store the solution in a well-stoppered polyethylene bottle.

B. EXPERIMENTAL

PROCEDURE

1. Add 5.0 ml of Extracting Acid to each of two centrifuge tubes containing the precipitate of magnesium carbonate and particulate organic matter obtained as described in Part IV.2. Suspend the precipitate by vigorously agitating the tubes with a tube buzzer.

2. Place the tubes in a sand-bath or block heater at 100 C for exactly 30 min (Note *a*). Remove the tubes and centrifuge the contents for 10 min at 5000 rpm. After centrifuging carefully withdraw the supernatant liquid with a capillary pipette attached to a vacuum source, being careful not to disturb the sedimented material (Note *b*).

3. Add 5.0 ml of the Extracting Alkali to each tube. Suspend the sediment by vigorously agitating the tubes with a buzzer and replace the tubes in the heater for exactly 30 min. Remove the tubes and centrifuge the contents for 10 min at 5000 rpm. Carefully withdraw the supernatant liquid with a capillary pipette attached to a vacuum source (Note *b*).

4. Add 5 ml of distilled water to each tube, mix the contents of the tubes with a buzzer, and centrifuge for 10 min at 5000 rpm (Note *c*). Carefully withdraw the supernatant with a capillary pipette (Note *b*).

5. Add 1.00 ml of distilled water to each tube. Proceed with the analysis of the contents of one tube as described in IV.8, Section E, paragraphs 2-3, starting with the additions of the anthrone reagent. To the second tube add 10 ml of the sulphuric acid reagent prepared for determining the "pigment blank" as described in Section F, paragraph 2, and continue as described therein (Note *d*).

6. Correct the extinction obtained for the sample to which anthrone was added by the extinction of a reagent blank, IV.8, Section F, paragraph 1, and the pigment blank as described above.

Calculate the crude fiber in terms of glucose standard using the factor F , obtained in IV.8, Section G, divided by 10:

$$\text{Crude fiber} = \frac{\text{corrected extinction} \times F}{10 \times V}$$

where V is the volume of sea water used (in liters).

NOTES

(a) In order to obtain reproducible results it is important to adhere to a strict time sequence throughout the procedure.

(b) It is not necessary to remove all the fluid when withdrawing the supernatant with a capillary pipette. In order to avoid disturbing the sedimented material it is advisable to allow about 0.1 ml of liquid to remain above the sedimented material.

(c) This treatment with distilled water cleans the precipitate from any remaining soluble carbohydrate and removes much of the remaining alkali.

(d) This pigment blank is not truly a pigment blank but it serves to correct for a certain degree of browning which may be induced by the acid and alkali treatments and should not be omitted.

IV.9. DETERMINATION OF CHITIN

INTRODUCTION

The following method for the determination of chitin is based on the Elson and Morgan method for glucosamine (*Biochem. J.*, 27: 1824, 1933). The necessary correction for the presence of carbohydrate and protein has been made by use of an equation based on the amount of interfering substance in the sample analysed. A better correction for the amount of interfering substances, involving their removal by ion exchange, has been described by Boas (*J. Biol. Chem.*, 204: 553, 1953). This correction is recommended for more precise estimations in a land-base laboratory. However, under shipboard conditions the correction employed here has been found to give a realistic value of the amount of interfering substances.

Results obtained by this method are a function of the glucosamine content of the particulate organic matter in sea water. Protein and carbohydrate both yield fractional amounts of colour but under the conditions of hydrolysis employed in this method the greater part of the carbohydrate is destroyed. A correction has been evaluated for the remaining carbohydrate and hydrolysed protein on the basis of the colours yielded by glucose and casein under the same conditions.

METHOD

A. CAPABILITIES

Range: 1-600 mg chitin/m³ (using between 10- and 0.5-liter samples)

PRECISION AT THE 15- μ G LEVEL

The correct value lies in the range:

$$\text{Mean of } n \text{ determinations } \pm 0.8/n^{\frac{1}{2}} \mu\text{g chitin.}$$

(Divide by the volume [in liters] of the seawater sample to get the corresponding data in mg/m³.)

B. OUTLINE OF METHOD

The chitin in the concentrated particulate matter from a sample of sea water is hydrolysed with hydrochloric acid. The glucosamine in the neutralized hydrolysate is acetylated with acetylacetone and condensed with *p*-dimethylaminobenzaldehyde to give a red solution the extinction of which is measured in a 10-cm cell.

C. SPECIAL APPARATUS AND EQUIPMENT

15-ml graduated centrifuge tubes (two for each determination) cleaned with hot chromic-sulphuric acid, rinsed with distilled water and stored, when not in use, in a dustproof container.

10-cm-path-length spectrophotometer cells holding 10 ml or less of solution.

D. SPECIAL REAGENTS

1. 95% ETHANOL

Use a good quality alcohol with no denaturing additives.

2. 6N HYDROCHLORIC ACID

Dilute 500 ml of analytical reagent grade concentrated hydrochloric acid (sp gr 1.18) to 1000 ml with distilled water.

3. DILUTE HYDROCHLORIC ACID SOLUTION

Dilute 100 ml of concentrated hydrochloric acid to 1000 ml with distilled water.

4. SODIUM HYDROXIDE SOLUTION

Dissolve 250 g of analytical reagent quality sodium hydroxide in 1000 ml of distilled water. Store in a well-stoppered polyethylene bottle.

5. PHENOLPHTHALEIN INDICATOR

Use a 1% w/v solution in 95% alcohol.

6. EHRlich's REAGENT

Dissolve 0.80 g good quality *p*-dimethylaminobenzaldehyde in 30 ml of 95% ethyl alcohol and 30 ml of concentrated hydrochloric acid. Store in a cool place in a well-stoppered glass bottle. The solution is stable for at least 1 week.

7. SODIUM CARBONATE SOLUTION

Dissolve 27 g of analytical reagent quality anhydrous sodium carbonate in 1000 ml of distilled water.

8. ACETYLACETONE REAGENT

Add 1.0 ml of pure acetylacetone (2,4-pentanedione) to 50 ml of sodium carbonate solution in a clean stoppered flask. Mix and *use within 15 to 30 min of preparation*. Do not store this reagent.

E. EXPERIMENTAL

PROCEDURE

1. Add 2.0 ml of 6N hydrochloric acid to the residue in a 15-ml centrifuge tube prepared as described in Part IV.2.

2. Place a glass stopper into the centrifuge tube and heat it in a sand-bath or block heater at 100 C for 4–8 hr (Notes *a* and *b*).

3. Remove the tube from the block heater and add 1 drop of phenolphthalein indicator. Neutralize the hydrolysate by running in 2 ml of sodium hydroxide solution. The indicator should turn pink. Back titrate with dilute hydrochloric acid solution until the indicator turns colourless then add 1.0 ml of acid in excess (Note *c*).

4. Make the volume of the hydrolysate up to 10 ml with distilled water, mix and centrifuge for 5 min (Note *d*).

5. Pipette 1.00 ml of the supernatant liquid into a 15-ml stoppered centrifuge tube. Add 1.0 ml of the acetylacetone reagent from an automatic pipette, mix, and heat the tube to 100 C for 15 min. (Notes *e* and *f*).

6. Remove the tube from the heater and cool it rapidly. Make the volume up to 9 ml with 95% ethyl alcohol and add 1.0 ml of Ehrlich's reagent from an auto-

matic pipette. Mix and allow the tube to stand for 30 min at room temperature (Note *g*).

7. Measure the extinction of the sample against water in a 10-cm cell at 5300 Å. Correct the extinction by the extinction of a blank determination carried out as described in Section F. Calculate the particulate chitin from the expression:

$$\text{mg chitin/m}^3 = \frac{\text{corrected extinction} \times F}{V}$$

where F is a factor determined as described in Section G and V is the volume (in liters) of sea water used. Correct this result for the effects of the presence of carbohydrate and protein as described later in Section F.

NOTES

(a) For surety 8 hr should be allowed to obtain a chitin value on marine samples but a good approximation would be found after only 4 hr.

(b) The solid should be mixed occasionally into the hydrolysing acid during the first few hours of this heating period using the tube buzzer.

(c) Neutralization is best carried out by placing the centrifuge tube against the side of a buzzer whilst adding the acids or alkali. An excess of 1 ml of dilute acid ensures that the solutions do not become alkaline owing to the slow dissolution of traces of precipitated carbonates. Rinse down the sides of the tube with a *little* distilled water to make sure that no alkali or acid is retained on the sides.

(d) The analysis may be left overnight or longer at this stage if desired.

(e) This one-tenth aliquot, although seemingly a little wasteful of sample, is necessary to get the correct acidity conditions.

(f) This period of acetylation should be controlled to within about 1 min and the tube cooled rapidly at its expiration.

(g) The extinction increases slowly even after 30 min but the increase is very slight in the next 10–15 min. All samples should be measured within about 30–45 min of adding the Ehrlich's reagent.

F. DETERMINATION OF BLANK

1. REAGENT BLANK

With each batch of samples a blank determination should be undertaken by carrying out the method exactly as described in Section E on a "blank" precipitate of magnesium carbonate obtained as described in Part IV.2. The extinction should not exceed about 0.02.

2. CARBOHYDRATE AND PROTEIN BLANK

The result for chitin obtained in Section E, paragraph 7, will be too great because the carbohydrate and protein present in organic particulate matter both give some colour with the reagents used in this method. Let C_G be the correct concentration of particulate chitin, C_D the concentration of chitin determined in Section E above, C_G the concentration of carbohydrate found by Part IV.8, and C_P the concentration of protein found by Part IV.6.II (by multiplying the nitrogen concentration by 6.25), all values being expressed in mg/m³.

Then:

$$C_G = C_D - 0.014 C_G - 0.0025 C_P$$

It will be observed that if the chitin is present in amounts less than about 1% of the amount of carbohydrate or 0.5% of the amount of protein only poor precision can be expected.

G. CALIBRATION

2. STANDARD CHITIN SOLUTION

Dissolve 0.300 g of D(+)glucosamine hydrochloride in water and make the volume to exactly 100 ml in a measuring flask.

$$1 \text{ ml} \equiv 3000 \mu\text{g chitin}$$

Note: One unit weight of chitin will hydrolyse in hydrochloric acid to give almost exactly (98%) the same weight of glucosamine hydrochloride.

Take 5.00 ml of this solution and dilute to exactly 100 ml with 6N hydrochloric acid. Prepare *immediately* before use.

$$1 \text{ ml} \equiv 150 \mu\text{g chitin}$$

2. PROCEDURE

Take five 15-ml centrifuge tubes. To two add 2 ml of 6N hydrochloric acid to act as blanks and to three others add 2.00 ml of dilute standard from a pipette. Continue the method exactly as described in Section E from paragraph 2 on, heating for the same period of time (between 4 and 8 hr) as used with samples. (Glucosamine is slowly deaminated in acid and the extent depends upon the time of heating.)

Find the mean of the three standard extinction values E_s and the mean of the two blank determinations E_b , and calculate a factor F from the expression:

$$F = \frac{300}{E_s - E_b}$$

The value of F should be approximately 275 and should be determined each time the period of hydrolysis (Sect. E, paragraph 2) is varied appreciably.

IV.10. DETERMINATION OF DESOXYRIBOSE (DNA)

INTRODUCTION

This is a modification of the Doebner-Miller quinaldine synthesis adapted by J. M. Kissane and E. Robins (*J. Biol. Chem.*, 233: 184, 1958). The fluorometric method measures desoxyribose but several compounds interfere. The elaborate separation procedure described below should make the technique specific for highly polymerized DNA. Experience may show that many of these separation steps can be bypassed in the application of the technique to the analysis of marine particulate material. We have, nevertheless, reported the full method. The application of this method to marine problems has been undertaken by W. H. Sutcliffe of the Fisheries Research Board of Canada, and his associates, and by O. Holm-Hansen of the Institute of Marine Resources, University of California. At the time of writing, a joint paper on methodology and results is planned. We are grateful to these workers for being allowed to report this technique prior to publication.

METHOD

A. CAPABILITIES

Range: 0.05–40 μg DNA/liter (2- to 0.5-liter samples)

1. PRECISION AT THE 20 $\mu\text{G/LITER}$ LEVEL

The correct value lies in the range:

Mean of n determinations $\pm 2/n^3$ $\mu\text{g/liter}$.

This precision and the limit of detection (*ca.* 0.1 μg) are only provisional figures. The technique requires considerable skill and practice.

B. OUTLINE OF METHOD

The particulate material from a sample of sea water, filtered onto a membrane filter, is extracted repeatedly with acetone, trichloroacetic acid, and ethanol. The residue is allowed to react with 3,5-diaminobenzoic acid and fluorescence of the solution in perchloric acid is measured by the Turner fluorometer.

C. SPECIAL APPARATUS AND EQUIPMENT

Tapered glass centrifuge tubes of 10- to 15-ml capacity.

Two 5-ml automatic pipettes.

100 lambda (0.100 ml) micropipette with a suitable micropipette manipulator.

Water bath held at 60 ± 2 C with compartments for holding the centrifuge tubes.

A thin round-ended rod to reach to the tapered end of the centrifuge tubes. Siphon or suction device ending with a length of fine capillary. (A Pasteur pipette is convenient.)

D. SAMPLING PROCEDURE AND SAMPLE STORAGE

See IV.2 for general comments. We have, as yet, insufficient experience to

specify the best conditions of sampling and storage. Presumably samples should be filtered without delay (*see* Section F, Note *b*).

E. SPECIAL REAGENTS

1. DIATOMACEOUS EARTH SUSPENSION

Add 0.25 g of laboratory grade diatomaceous earth to 100 ml of distilled water. Store in a glass bottle and *shake vigorously* each time immediately before use.

2. ACETONE ANHYDROUS

Add a few grams of anhydrous sodium sulphate, Na_2SO_4 , to a bottle of analytical reagent grade anhydrous acetone. Shake the bottle and use the clear solvent decanted from the salt.

3. ACETONE 90%

See IV.3.I.E.1.

4. TRICHLOROACETIC ACID (TCA)

Dissolve 100 g of analytical reagent quality trichloroacetic acid, CCl_3COOH (TCA), in 1000 ml of distilled water. Store in a glass bottle at about 5 C in a refrigerator.

5. ETHANOL 95%

Add 25 ml of distilled water to 500 ml of absolute ethyl alcohol, $\text{C}_2\text{H}_5\text{OH}$. Store in a stoppered glass bottle.

6. 3,5-DIAMINOBENZOIC ACID DIHYDROCHLORIDE SOLUTION (DABA)

Add sufficient 3,5-diaminobenzoic acid (about 10g) to 100 ml of boiling 50% v/v hydrochloric acid until no more dissolves. Add a few milliliters extra acid to clear the solution (neglect any *slight* precipitate) and then cool to about 5 C in a refrigerator. Filter the cold solution rapidly through the sintered glass plate base of a Millipore filtration apparatus. Do not wash. Scrape off the salt with a plastic spatula and dry it at 60 C. Grind the dry solid to a fine powder and store it in a small glass bottle. If the solid is very dark it is best to treat the above solution with activated charcoal and filter hot before the crystallization step. This procedure reduces the value of blanks.

For immediate use add 1.0 ml of distilled water to 0.40 g of DABA dihydrochloride in a clean dry test tube.

7. PERCHLORIC ACID

Add 30 ml of 70–72% analytical reagent quality perchloric acid, HClO_4 , to 500 ml of distilled water. Store in a glass bottle.

F. EXPERIMENTAL

PROCEDURE

1. During the filtration of 0.5–2 liters of sample through a 47-mm Millipore HA membrane filter add 1.0 ml of diatomaceous earth suspension (Note *a*). Suck the filter dry and remove it to the bottom of a centrifuge tube (Note *b*).

2. Add 5.0 ml of anhydrous acetone, mix the contents of the tube with a tube

buzzer. Allow the material to extract for 30 min at room temperature and then centrifuge it (Note *c*).

3. Remove the top clear layer of solvent (Note *d*) by suction up a capillary tube and repeat the whole operation described in this and the previous paragraph three or four more times (Note *e*).

4. Resuspend the solid in 5.0 ml of 90% acetone, centrifuge the suspension, and remove as much solvent as possible without disturbing the pellet (Note *f*).

5. Add 5.0 ml of *cold* (5 C) TCA with an automatic pipette, mix the contents of the tube with a tube buzzer for a few moments and allow the material to extract at about 5 C for 15 min. Centrifuge (Note *c*) and remove the supernatant liquid with the capillary (Note *g*).

6. Extract twice with 95% ethanol using exactly the same technique as with acetone (Note *h*).

7. Dry the pellet at the bottom of the centrifuge, obtained as described in paragraph 6, at 60 C for 2 hr.

8. Add 0.100 ml of DABA solution with the micropipette (Note *i*) and heat the tube for 1 hr at 60 C (Note *j*).

9. Cool the tube and add 5.0 ml of perchloric acid from a pipette. Mix the contents of the tube with a tube buzzer, allow the solution to stand for 5 min, and, finally, centrifuge down the solid.

10. Decant into a Turner fluorometer tube and measure the fluorescence using the Turner filter 405 for the excitation light and a combination of Corning filters (CS4-105) (Note *k*) for screening the fluorescent light. Zero the fluorometer, as indicated in method IV.3.IV with a tube containing the blank (*see* Section G).

11. Calculate the micrograms of DNA per liter from the expression:

$$\mu\text{g DNA/liter} = \frac{F \cdot S \cdot R}{V}$$

where *F* is a factor obtained as described in Section H, *S* is the door factor, and *V* the volume of sample in liters.

NOTES

(*a*) This small addition, which can be made at any time during the filtration, prevents the loss of DNA during the multiple extraction processes to be described later.

(*b*) This is the most convenient time for sample storage if necessary. Keep tubes capped by foil at -20 C. We have made no tests but, presumably, the tubes can be stored for many weeks without loss of DNA.

(*c*) About 1500 *g* for 5 min is sufficient.

(*d*) During the first one or two extractions, three layers will be found in the tube—a precipitate, a cloudy liquid, and a top clear liquid. After most of the membrane filter solution has been removed there should only be one liquid layer. The acetone treatments remove lipids, and dissolve and wash away the membrane material.

(*e*) The number of times necessary depends on the course of the extraction. Resuspend the solid obtained after the third centrifugation in more acetone by means of the thin glass rod. If the solid disperses readily no further extractions are necessary.

(*f*) The need for this 90% acetone treatment is not fully established.

(g) This treatment with cold TCA is to remove bases.

(h) This treatment with ethyl alcohol is to remove most other small molecular weight compounds.

(i) This is a critical stage of the method. The pellet of dry solid at the bottom of the tube should be completely wetted and covered with the DABA solution with no trapped air bubbles. Do not shake the solid up the side of the tube where it cannot react properly with the added reagent.

(j) The temperature should be controlled to within 1 or 2 degrees. About 30 min is required for full colour development. An hour is recommended as a safe excess.

(k) The peak of emitted fluorescence at 5200 Å is near the optimum wavelength for excitation (4200 Å) necessitating a careful choice of filters. The thinner of the two blue filters in the Corning assembly can be removed in order to attain a slightly greater sensitivity. Doors 1-30 can be used. The solution is stable for days and does not lose its fluorescence properties on standing.

G. DETERMINATION OF BLANK

Carry out the determination as described in Section F.1-10, putting only a few milliliters of distilled water through the filter. Use this solution to zero the fluorometer on each door when analyzing a batch of samples and standards. The fluorescence measured against water using door 30 should not exceed about 50 units.

H. CALIBRATION

1. STANDARD DNA SOLUTION

Use salmon-sperm DNA (obtainable from the Sigma Chemical Company). Dissolve 15.0 mg in 100 ml of 8% v/v ammonium hydroxide solution.

$$1 \text{ ml} \equiv 150 \mu\text{g DNA}$$

Add 0.100 ml of this standard to each of 3 dry empty test tubes and put aside another empty tube for the blank. Slowly dry the standards at 60 C until no more water remains and the DNA is present as a film over the bottom of the tube. Add 0.1 ml of DABA solution and continue as described in Section F, paragraphs 8-10, but measure against this blank, not the one obtained as described in Section G, using door 1 on the fluorometer. Calculate the factor F from the mean of the three fluorescence readings, R , and the expression:

$$F = \frac{15}{R}$$

Note: The door factor on door 1 is unity by definition. It is best to determine experimentally the factors for doors 3, 10, and 30 by the serial dilution (with perchloric acid) of a standard (*cf.* the Addendum to method IV.3.IV) as the factors may not be exactly 3, 10, and 30.

IV.11. DETERMINATION OF ADENOSINE TRIPHOSPHATE (ATP)

INTRODUCTION

The determination of adenosine triphosphate (ATP) in the particulate matter of sea water is of value as an indicator of the quantity of living material, although it says nothing of the nature of this material. The approach is particularly useful for estimates made below the euphotic zone where no other convenient indicator (e.g. chlorophyll *a* in surface waters) is available. The idea for this approach came from an article by G. V. Levin et al. (*Bioscience*, 14: 37, 1964) and the methodology is taken from O. Holm-Hansen and Booth (*Limnol. Oceanog.*, 11: 510, 1966).

METHOD

A. CAPABILITIES

Range: 1.0–4000 m μ g/liter (2- to 0.5-liter sample)

1. PRECISION AT THE 50 M μ G/LITER LEVEL

Mean of n determinations $\pm 3/n^3$ m μ g/liter.

2. LIMIT OF DETECTION

With the method as written this is governed by the purity of the enzyme preparation and could, in theory, be considerably reduced below the present value of 1.0 m μ g/liter with a 2-liter sample.

B. OUTLINE OF METHOD

The ATP in material filtered onto a membrane filter is extracted by boiling Tris buffer. The light emitted when an aliquot of this extract is added to an extract of firefly lanterns is measured by a sensitive photomultiplier and is proportional to the amount of ATP present. The ATP provides the energy source for a light-emitting oxidation of a substrate, luciferin, under the influence of an enzyme, luciferase, both being present in the firefly lanterns.

C. SPECIAL APPARATUS AND EQUIPMENT

5-ml automatic pipettes.

2 \times 200-lambda (0.200-ml) micropipette with a suitable micropipette manipulator.

Glass vials 25 \times 57 mm.

150-ml glass beaker with coverglass.

Pyrex test tubes, 10-ml capacity marked on the side with a scratch at 4.0 ml.

Parafilm squares for covering test tubes.

Boiling water bath with compartments to hold 150-ml beakers.

A suitable holder for the glass vials to be built on top of a photomultiplier tube is sketched in Fig. 5.

An RCA 6810-A photomultiplier tube should be used, powered by a 2000 V stabilized power pack. The output is fed into a d-c amplifier capable of taking

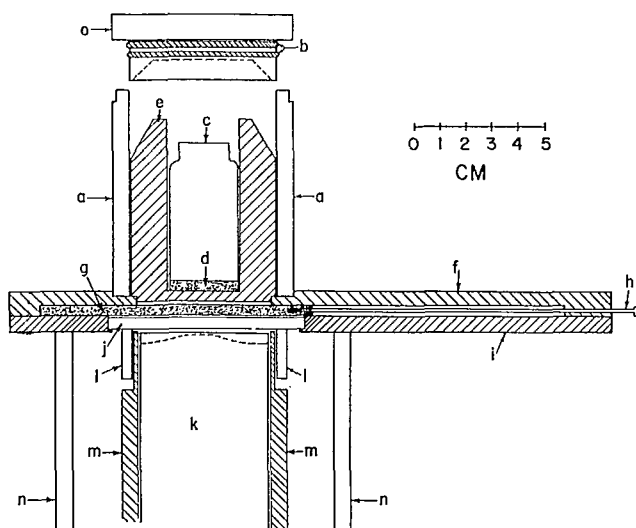

FIG. 5. Determination of ATP. Detailed longitudinal section of the upper half of the sample holder. a. cylindrical aluminum shield for sample; b. two O-rings; c. glass vial; d. enzyme preparation; e. Plexiglas sample holder; f. $\frac{3}{8}$ -inch (0.95-cm) aluminum sheet, 23.5×12.7 cm; g. sliding diaphragm; h. stainless steel rod; i. $\frac{1}{4}$ -inch (0.63-cm) aluminum bottom support for diaphragm; j. Plexiglas window; k. RCA 6810-A photomultiplier tube; l. Plexiglas collar for positioning of phototube; m. aluminum shield for tube, charged to same voltage as cathode (about $-2,000$ v); n. cylindrical aluminum light shield, 11.4-cm diam; and o. lighttight cap. The cap and the diaphragm are lubricated with anhydrous lanolin. (Reproduced by permission from *Limnol. Oceanog.*, 11(4): 512, 1966.)

0.1–1000 μ amps and feeding the amplified signal to a millivolt pen recorder with a chart speed of about 5 cm/min. With such a wide range of voltages a range-selector sensitivity switch, covering a 10,000-fold range in steps of about 3-fold change, should be added. We have found that a Fluke 405-B High Voltage Supply (John Fluke Mfg. Co., Inc., Seattle, Washington) and a Hewlett Packard 425A Microammeter, connected to a Leeds and Northrup Speedimax Recorder, satisfies the above specifications.

Note: It is imperative that the 6810-A tube not be exposed to daylight or even to room light when it is energized. For safety the sliding diaphragm should activate switches so that the voltage is removed from the tube before the diaphragm is opened unless a cover is on top of the vial holder.

D. SAMPLING PROCEDURE AND SAMPLE STORAGE

A clean alcohol-sterilized Van Dorn bottle or similar sampler can be used for euphotic zone work but it is preferable (and essential for deep samples) to use a sterile sampler of 1- to 2-liters capacity. Samples should be processed as quickly as possible after bringing them on deck. This means extractions must be undertaken on board ship but the frozen extracts (*see below*) can be stored for many months and the analyses completed in a shore-based laboratory.

E. SPECIAL REAGENTS

1. TRIS BUFFER

Dissolve 7.5 g of trishydroxymethylaminomethane in 3000 ml of distilled water. Adjust the pH to between 7.7 and 7.8 by the dropwise addition of 20% hydrochloric acid. This solution should be dispensed into clean 250-ml Erlenmeyer flasks to the extent of about 150 ml per flask, the flasks stoppered with suitable loose fitting caps (cotton wool in cheesecloth, stainless steel caps, etc.) and autoclaved at 15 psi for 15 min. Use the contents of each flask for one batch of samples and standards and then discard them.

2. ENZYME MIXTURE

Use vials containing each about 50 mg of lyophilized firefly lantern extracts. A high quality supply is essential for the good working of this method. We have found the Sigma Chemical Co. product consistently satisfactory. Add 5.0 ml of Tris buffer to a vial of lantern extracts and allow it to stand at room temperature for 2-3 hr. Centrifuge the mixture and decant the clear solution into a clean, dry test tube. Allow this extract to stand for a further 60 min and then use a batch of extracts within the next 3 hr.

F. EXPERIMENTAL

PROCEDURE

1. Filter between 0.5 and 2 liters of sample (Note *a*) through a 47-mm Millipore HA filter. Suck the filter dry but do not wash it (Note *b*).

2. Put the filter on the bottom of the 150-ml beaker and pipette with a 5-ml automatic pipette 3.0 ml of *boiling* Tris buffer (Notes *b* and *c*).

3. After the extraction has proceeded for 5 min (Note *d*) decant from the beaker into a clean, dry test tube. Rinse the beaker and filter with a further 1.0 ml of boiling Tris buffer and add this to the other extract in the test tube (Note *d*).

4. Cool the contents of the tube to room temperature. Add a few drops of Tris buffer, if necessary, to bring the volume to the 4.0 ml mark, mix, and cover the tube with parafilm (Note *e*).

5. Pipette 0.200 ml of enzyme preparation into a glass vial (Note *f*), place the vial in the sample holder and record a base line of light emission at a few sensitivity settings around that anticipated as necessary for the sample determination (Note *g*).

6. Close the shutter and remove the vial. With a new micropipette (Note *f*) measure out 0.200 ml of sample into the vial (Note *f*) and note the time. *Immediately* swirl the contents to mix. Place the vial back into the sample holder and 10 sec after adding the sample open the shutter and quickly adjust the range-selector sensitivity switch until a suitable output is measured on the pen recorder.

7. Trace the output curve for 2-3 minutes (Note *h*) and measure the area under the curve drawn by the pen in a known standard period (Note *h*) and a base line made by extending the base line found in paragraph 5, above, at the same sensitivity setting.

8. Correct the sample area for a blank area obtained as described in Section G

below and then calculate the concentration of adenosine triphosphate as millimicrograms per liter from the expression:

$$\text{m}\mu\text{g ATP/liter} = \text{corrected area} \times S \times \frac{F}{V}$$

where F is a factor obtained as described in Section H below and S is the range-selector sensitivity setting. (The most sensitive setting is called unity and the others might be 3,9,27, etc., according to the instrumentation.) V is the volume of sample in liters.

NOTES

(a) Generally 1 liter is suitable. For the deepest ocean samples, 2 liters would be better. In very eutrophic waters it may be necessary to take 500 ml but this is unlikely with the 10,000-fold range of sensitivity obtainable with the photomultiplier specified in this method.

(b) There is evidence that destruction of ATP starts within 15 sec of sucking a membrane-filter dry so there should be no delay between filtration and extraction.

(c) A cold beaker is used to prevent a variable kill of organisms before the buffer is added. The buffer, however, must be boiling so that the heat kills the cells instantly and deactivates enzymes before any ATP destruction is possible. We have had poor results if the buffer has been other than at 100 C.

(d) The extraction of ATP is not immediate, even from bacteria, and a few minutes should be allowed. A second small wash after the 5-min preliminary extraction has proven adequate to remove all ATP from the filter.

(e) At this stage extracts can be stored for many months in the dark at -20 C.

(f) Do *not* use the mouth with this pipette. There are several forms of micropipette manipulators available. Use the pipette for samples with progressively *increasing* amounts of ATP or, for surety, rinse with buffer between samples. Use a different pipette for enzyme and samples.

(g) Experience soon indicates a suitable setting, or this can be found by trial. There is little variation of base line with setting for S values over about 100. The light emitted is as "noise" from the lantern extracts and this decreases rapidly when extracts are allowed to stand (see Section E.2). The advantages of this decrease in "blank," however, are eventually offset by a slow loss of activity in the enzyme preparation, which should not be more than about $\frac{1}{2}$ -day old.

(h) Experience has shown that an area measurement of an output versus time plot gives the best proportionality to ATP concentration but the time (chart distance) used is a matter of choice, provided that most of the initial burst of light is recorded. We have found 1.5 min to be a suitable time. The total record should be somewhat longer than the part used for area measurement, i.e., 2-3 min. The very intense initial output (during the first few seconds) adds little to the overall sensitivity and the system is best allowed to "settle down" for 10 sec before starting to make measurements.

G. DETERMINATION OF BLANK

Filter sea water, preferably taken from beneath the euphotic zone, through a Millipore HA filter into a clean flask and then refilter immediately 1 liter of this filtrate through a new HA filter. Carry out the determination exactly as described in Section F.1-7 above on this second filter, taking a mean area from a duplicate determination carried out at the sensitivity setting of 1. When other sensitivity settings are used divide this area by the appropriate sensitivity setting value, S , found to be required in any batch of samples. The curves traced will be negative, i.e. with little or no added ATP, the addition of 0.200 ml of Tris buffer suppresses the light

emission first recorded from the 0.200 ml of lantern extract (paragraph 5). Blank and similar areas are assigned a negative sign. Correct sample areas by subtracting the blank areas algebraically. If only small quantities of ATP are present the sample areas may also be negative but the correction also applies. (e.g.: sample area +5, blank area -2, corrected area = +5 - (-2) = 7; sample area -1, blank area -2, corrected area = -1 - (-2) = 1; sample area 0, blank area -3, corrected area = 0 - (-3) = 3.)

Note: No great precautions are generally needed with glassware but tubes and beakers are best cleaned in hot chromic-sulphuric acid, rinsed well with distilled water, and dried immediately. Glassware must be kept *dry* to prevent the growth of organisms and the associated production of ATP.

H. CALIBRATION

1. STANDARD ADENOSINE TRIPHOSPHATE SOLUTION

Dissolve 12.3 mg of disodium adenosine triphosphate, $C_{10}H_{16}N_5O_{13}P_3Na_2 \cdot 4H_2O$, in a liter of distilled water. Store frozen in a glass bottle. The standard is stable for many months.

Dilute 1.0 ml to 100 ml with Tris buffer.

$$0.200 \text{ ml} = 20 \text{ m}\mu\text{g ATP}$$

Prepare fresh for use and keep only a few hours.

Carry out this method as described in Section F.5-7 above using 0.200 ml portions of this standard. It is generally sufficient to find the light emission from 3 standards measured about halfway in time through a batch of samples. Correct the mean of the three areas with the mean of the area of two blanks using only 0.200 ml of Tris buffer. If A is the corrected area at a sensitivity setting of S :

$$F = \frac{400}{S \times A}$$

The above assumes that the area is a linear function of ATP concentration over a wide range of concentration. This has been found to be the case with our assembly but it should be checked with any new apparatus.



IV.12. ELECTRONIC SIZING AND COUNTING OF PARTICLES

In the following description it is assumed that the reader has at his disposal a Model B Coulter Counter® which has been set up as an operational instrument by a company representative. Precise details on the operation of this instrument are given in *A Practical Manual on the Use of the Coulter Counter® in Marine Science* by R. W. Sheldon and T. R. Parsons (Published in 1966 by Coulter Electronics Sales Company—Canada) and the subject is discussed further by Sheldon and Parsons (*J. Fish. Res. Bd. Canada*, 24: 909, 1967). The following account is to some extent an abbreviated set of instructions obtained from the publication cited above. Only the essential operation of the instrument, the preparation of samples, and two basic types of particle distributions are dealt with here. For greater working details as well as for descriptions of accessory apparatus, the reader is referred to the manual cited above.

IV.12.I. DESCRIPTION OF APPARATUS

The apparatus specified in the following procedures is a Coulter Counter® Model B. A detailed description of the electronics of this instrument is given in a manual provided by the manufacturer. The description given here is only intended to serve as an introduction to the use of the apparatus and to identify certain controls which have to be operated.

The instrument consists of an electronic cabinet and a sampling stand. The former contains a digital counter, an oscilloscope screen, upper and lower threshold controls, aperture current and amplification switches, and a zero reset switch. The sampling stand consists of an aperture tube, a mercury manometer, a control stop-cock, two electrodes, a vacuum pump, and a 35× microscope for viewing the aperture.

A vacuum created by the pump is used to draw a sample of electrolyte through the aperture. Particles contained in the electrolyte displace an amount of fluid proportional to their size and number, and this is sensed in the aperture of an electric current. The latter is maintained by having one electrode outside the aperture tube and one inside. The number of particles in a known volume of electrolyte can be determined by using the manometer as a metering device. This is accomplished by allowing the mercury to flow back through the manometer after applying a vacuum. In so doing the mercury passes start and stop contacts which activate the counter to enumerate particles in a known volume. An alternative procedure, especially recommended for large apertures and shipborne operations, is to employ a time switch in place of the mercury column and to count particles for a known time. The quantity of electrolyte passed during a set time-interval can then be determined from the flow rate for a particular aperture.

The upper and lower thresholds act as electronic gates, above and below which no particles are counted. The controls may be operated in two ways and this is

decided by a threshold mode switch marked *separate* and *locked*, to be found inside the instrument. In the *separate* position the particles counted will be those which are of a size falling between the threshold values set on the upper and lower dials (provided the upper threshold is set above the lower). In the *locked* position a constant distance is maintained between the two thresholds and the width is determined by the position of the upper threshold. Thus if the upper threshold is set at 50, the particles counted will be between the lower threshold setting and the lower threshold setting plus 5.

At each change of setting, the aperture current switch doubles the current, and the amplification switch doubles the instrument response. For the purpose of this text the combined effect of the aperture current and amplification settings has been expressed as a multiple and called the *sensitivity*.

The oscilloscope provides a visual picture of the particles as they pass through the aperture and the effects of the upper and lower thresholds appear as darkened bands on the screen. The zero reset switch reverses the polarity across the aperture and must be reset between counts.

The instrument used by us was stable over a temperature range of 5–25 C and a salinity range of 8–40‰ but these values should be checked for a particular calibration. At higher or lower temperatures and salinities, the instrument should be calibrated specifically for the medium employed.

IV.12.II. CALIBRATION

Calibration of different sized apertures may be carried out with any uniformly sized particles of known volume having a diameter between 2 and 40% of the aperture being calibrated. In practice it has been found convenient to use pollen grains or plastic spheres. The former can be purchased from Hollister-Stier Laboratories, P.O. Box 14197, Dallas, Texas, USA, in sizes ranging from 16 to 90 μ (e.g. Paper mulberry pollen, 16 μ ; Ragweed pollen, 19.5 μ ; Pecan pollen, 45 μ ; Corn pollen, 90 μ). The plastic spheres of very small sizes (e.g. 1–10 μ) can be obtained from the Dow Chemical Co., Midland, Michigan, USA. For the largest apertures it is necessary to use particles such as crab eggs (400 μ).

Particles should be suspended in membrane-filtered sea water by shaking, and left for 24 hr to separate and become uniformly hydrated. The diameter of the material employed by calibration should be checked under a microscope and the procedure carried out as follows:

1. With the threshold mode switch set at *separate*, set the lower threshold at 5 and the upper threshold at 100. Adjust amplification and aperture current settings so that the particles appear one half to two thirds of the way up the oscilloscope screen.

2. Count the number of particles in a known volume and express the count as the number of particles per milliliter.

3. Adjust the number of particles in the seawater sample so that there are less than the number causing a 5% coincidence (*see* Table XVII). For aperture sizes not shown in Table XVII coincidence may be approximated from the expression

$$\frac{(D_1)^3}{(D_2)^3} \times C_2$$

where D_1 is the diameter of the new aperture and D_2 is the diameter of the aperture for which the coincidence (C_2) is known.

4. Set the threshold mode switch to *locked* and the upper threshold to 50. With the lower threshold set at 5, take two counts of the number of particles for a set time interval, or in a standard volume of sea water.

5. Move the lower threshold to 10, keep the upper threshold at 50, and repeat the two counts. Continue to move the lower threshold up at intervals of 5 threshold settings, making two counts after each move and keeping the upper threshold set at 50.

6. Plot the results obtained as shown in Fig. 6 and determine the mode of the first peak. Subsequent peaks may occur in this plot but these are due to two or more particles being stuck together.

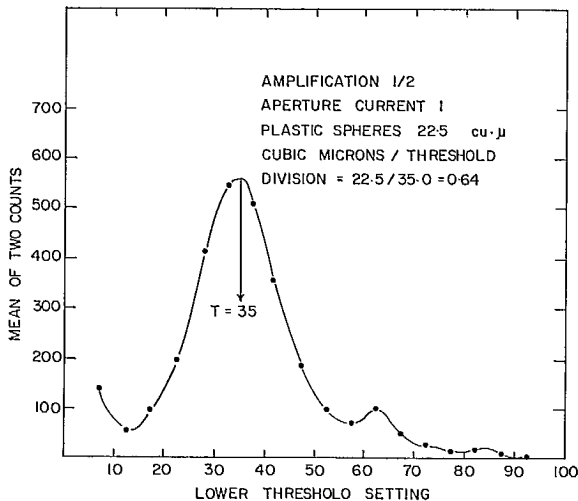

FIG. 6. Size distribution of plastic spheres used for the calibration of a 30- μ aperture.

7. Note amplification and aperture current settings. Divide the volume of the particle used for calibration by the threshold value for the mode.

Example: The example shown in Fig. 6 is for the calibration of a 30- μ aperture using plastic spheres of 22.5 μ^3 volume. The calibration factor obtained at a sensitivity of 0.5 is 0.64 μ^3 . If the sensitivity is changed, e.g. to 4, each threshold setting is then equivalent to $(4/0.5) \times 0.64 = 5.1\mu^3$.

IV.12.III. PREPARATION OF SAMPLE

IV.12.III.1. SUSPENDED MATERIALS

For naturally occurring suspended materials it will generally not be necessary to concentrate or dilute seawater samples over the size range 3–100 μ . For particles larger than 100 μ in diameter, the material may be concentrated on a sieve. Particles in the size range 100–500 μ should be concentrated with a 50- μ sieve; larger particles are best collected with a 300- μ mesh diameter net towed through the water; and the largest particles (i.e. greater than 2000 μ) are best removed with a sieve and discarded. The degree of concentration will depend on the environment but for particles greater than 300 μ in diameter a thousandfold concentration will generally be necessary. Netted samples are resuspended in a known volume of membrane-filtered sea water. Resuspension is readily accomplished by ordinary mixing but for particles greater than 300 μ in diameter, *vigorous* stirring is necessary. In addition, an enlarged seawater reservoir is required to allow for the greater volume of sample drawn through the larger apertures.

For phytoplankton cultures it may be necessary to dilute the sample in order to avoid coincidence corrections. From a preliminary count of the sample, and with reference to Table XVII, it may be determined if the count exceeds an acceptable level of coincidence. Generally, counts which have a coincidence correction of greater than 5% should be diluted. Dilution to a known volume should be made with membrane-filtered (0.22 μ) sea water.

When natural seawater samples are being counted with small apertures it is necessary to remove much of the larger material in order to avoid repeated blocking of the aperture and, in some cases, the possibility of larger particles masking the presence of smaller particles. For this purpose, sieves should be employed, which will in no way affect the distribution and number of the smaller particles being measured. It is recommended that sieve sizes no smaller than from 1 to 1.5 times the aperture size be employed for this purpose.

IV.12.III.2. SEDIMENTED MATERIALS

Recently deposited inorganic particulate material may be readily sized with a Coulter Counter®. The procedure followed in preparing the samples depends to some extent on the approximate grain size of the particles. In general, however, ignition in a furnace removes organic material from larger particles (100 μ); the addition of hydrogen peroxide with warming on a hotplate to aid digestion cleans smaller particles; and a small amount of dilute hydrochloric acid removes carbonates.

In the latter case excess acid should be removed by washing before sizing the material in the counter.

Particles are readily resuspended by agitation for 5 min in an ultrasonic bath. Samples should be resuspended in a saline solution, or in glycerol-saline if the particles are larger than 100 μ in diameter. The following chart provides a guide to the treatment of any particular sediment sample.

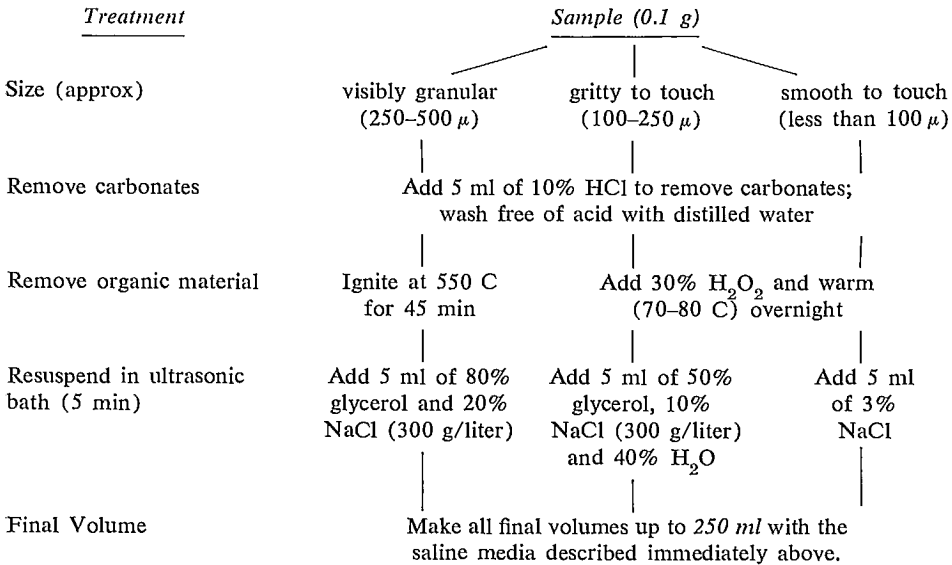

In combination with the procedure described above, the use of screens also may be necessary in making preliminary separations of sediments. In this case a combination of one or more of the procedures shown in the above flow chart may be useful.

IV.12.IV. PARTICLE SPECTRA

The choice of an appropriate particle size scale on which to express the distribution of particulate material depends on the range of particle sizes encountered. For particles with a small size range, the distribution of sizes may be expressed on an arithmetic scale of particle diameter (along the abscissa), and as either numbers or volume of particles (along the ordinate). This type of distribution is best suited for unicellular algal cultures or occasionally for natural populations of a monomictic bloom. However, for the great range of particle sizes encountered in most natural populations of suspended materials, as well as among sedimented particles, it is necessary to express particle size on a logarithmic scale of particle diameter (along the abscissa), and the quantity of material as the volume not

number (along the ordinate). A discussion of the use of this type of size spectrum has been given by Sheldon and Parsons (*J. Fish. Res. Bd. Canada*, 24: 909, 1967), and a suitable grade scale to employ for the Coulter Counter® is given in Table XVI.

IV.12.IV.1. ARITHMETIC DISTRIBUTIONS

METHOD

A. CAPABILITIES

Providing the coincidence correction is less than 5% (*see* Table XVII), the precision of counts made with the Coulter Counter® is a function of the number of particles counted. The precision decreases with the total number of particles counted but is independent of the size of the aperture tube employed. The following data will serve as a guide to the precision of count data. (Confidence limits given are two standard deviations.)

For a count of 2000	the true count is	2000 ± 65	(3.3%)
For a count of 200	the true count is	200 ± 12	(6%)
For a count of 70	the true count is	70 ± 11	(16%)
For a count of 30	the true count is	30 ± 8	(27%)

B. EXPERIMENTAL

PROCEDURE

1. Select an aperture tube such that the particles being examined have a diameter between 2 and 40% of the aperture size.
2. Follow the procedure described in Section IV.12.II,1-5.
3. Plot the mean of two counts as the number of particles per unit volume of medium versus the diameter of the particle in each size category. The latter scale is obtained by multiplying the threshold scale (such as is shown in Fig. 6) by the calibration factor for the particular sensitivity employed, and determining the diameter of the volume obtained, assuming the particles to be spherical (*see* Note *below*).

Note: In both procedures for arithmetic and logarithmic distributions it is recommended that the particle diameter be used as a measure of size. In doing this it is recognized that the property actually measured is volume and that the diameter given is that of a sphere having the same volume as the particle.

IV.12.IV.2. LOGARITHMIC DISTRIBUTIONS

METHOD

A. CAPABILITIES

The precision of counts and coincidence corrections are the same as described previously in Section IV.12.IV.1 and in Table XVII.

B. EXPERIMENTAL

PROCEDURE

1. Select an aperture tube such that the particles being examined have a diameter between 2 and 40% of the aperture size (Note *a*).

2. Set the sensitivity at the minimum setting, i.e. for counting the smallest particles (*see Note b*), and the lower threshold at the lowest level used for making counts. (In the example given in *Note b* this threshold value would be 46.3.) Set the upper threshold at 100.

3. Count the particles in a suitable volume of medium and express the count as the number per milliliter. Adjust the volume of the medium if the count exceeds 5% coincidence (Table XVII).

4. Set the upper and lower thresholds at the required values for obtaining the number of particles in the size categories shown in Table XVI (*Note b*) and make two counts at each sensitivity setting until the maximum sensitivity is reached.

5. Express the mean of two counts as the number of particles in a known volume of medium (e.g. 1 ml) and multiply the count by the geometric mean volume for each size interval (the geometric mean volume is given in column 3 of Table XVI). The results may then be plotted as the volume of material found in the size categories shown in the fourth column of Table XVI. These results give amount as a logarithmic progression of particle diameters (*Note c*). An example of a logarithmic particle size distribution is given in Fig. 7.

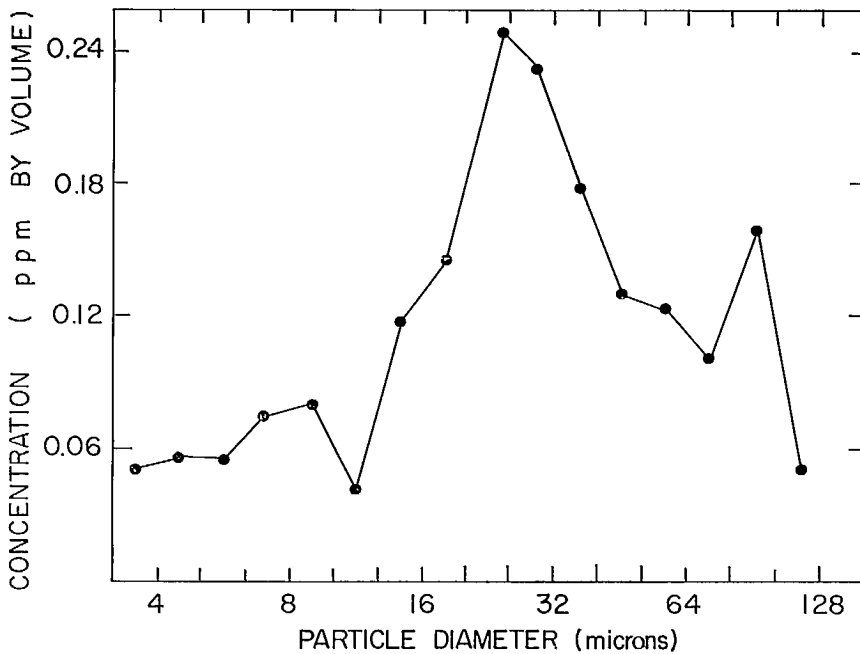

FIG. 7. An example of a logarithmic size distribution of suspended particulate material.

NOTES

(a) In this procedure it is often necessary to use two or more apertures in order to cover a wide range of particle sizes. The stepwise description given here is for the use of one aperture, and the use of a second larger or smaller aperture will follow the same procedure. Since the grade scale given in Table XVI is continuous, the portion of the scale covered by one aperture may be joined up with an adjacent portion of the scale which is covered by a second aperture.

(b) The required threshold settings have to be determined only once for each tube, providing there are no subsequent changes made to the electronics of the counter. From information obtained under Section IV.12.II (Calibration), the particle volume corresponding to one threshold setting at a known sensitivity will have already been obtained. It is now necessary to determine the threshold settings (upper and lower) which will give any two adjacent volumes in the left hand column of Table XVI. The following example serves to show how this is done:

Suppose that with a 200 μ aperture, one threshold setting corresponds to $1.48 \times 10^3 \mu^3$ at a sensitivity of 64 (i.e. aperture current 1, amplification 64). Then at this sensitivity particles in the size range 68.7×10^3 to $137 \times 10^3 \mu^3$ (see Table XVI) could be measured if the upper and lower thresholds were placed at

$$T = \frac{137 \times 10^3}{1.48 \times 10^3} = 92.5 \text{ (upper)}$$

and

$$\frac{68.7 \times 10^3}{1.48 \times 10^3} = 46.3 \text{ (lower)}$$

Since the movement of the amplification or aperture current settings corresponds to a $2\times$ volume scale, it is clear that the logarithmic scale of particle diameter given in Table XVI can now be followed by leaving the upper threshold setting at 92.5 and the lower threshold at 46.5, and changing the sensitivity by a factor of 2 each time a count is taken. (*Note:* Either amplification or aperture current controls may be employed to change the sensitivity.) In this case the minimum sensitivity will be found from the diameter in Table XVI corresponding to 2% of the aperture size, and the maximum sensitivity will be found from the diameter in Table XVI corresponding to 40% of the aperture size.

(c) By designing a suitable data form, the calculations associated with the conversion of particle numbers in a certain volume, to particle volume in a standard volume of medium can readily be carried out with a computer.

IV.13. AUTOMATED DETERMINATION OF RELATIVE TURBIDITY WITH A FLUOROMETER

INTRODUCTION

In ecological studies on particulate materials in aquatic environments it is often useful to have a method available which can give a rapid indication of the *in situ* occurrence of maxima in particle concentrations. For this purpose we have employed a G. K. Turner fluorometer as described by Stephens (*Deep-Sea Res.*, 14: 465, 1967). The advantages of this instrument are that it is easily maintained, it is readily adapted to automation, and it is complete without an outboard sensing device.

METHOD

A. CAPABILITIES

The property measured in this procedure is the scattering of light by particulate material. Since this is dependent on the quantity, size, shape, and coefficient of reflection of suspended particles, the capabilities of the method will vary with the material encountered. For dilute solutions of a uniform suspension of small particles (1–5 μ) there is a linear and highly reproducible response between scattering and the quantity of material present. Under these conditions quantities of suspended material down to 100 $\mu\text{g/liter}$ are readily detected with the instrument. Under natural conditions the limit of detection and the reproducibility will depend on the nature of the material, but in general the clearest coastal seawater samples which we have encountered (transmission of 80% per meter at 430 $m\mu$) gave readings 30% higher than distilled water. By appropriate adjustment of scales on the instrument, the greatest quantities of material measured with the instrument were about 500–1000 mg/liter .

B. OUTLINE OF METHOD

In the following procedure a G. K. Turner fluorometer is employed as a nephelometer by measuring light scattered at right angles to an incident beam. The quantity of light scattered is taken as a measure of the amount of particulate material. The procedure is automated by allowing sea water to flow directly through a cuvette and measuring the instrument response on a suitable recorder. The apparatus can readily be used in conjunction with a second fluorometer for measuring chlorophyll *a* (*see* Section IV.3.IV).

C. SPECIAL APPARATUS AND EQUIPMENT

G. K. Turner fluorometer fitted with a F 4T5 blue fluorescent light.

Flow-through cuvette, 1 cm square cross section.

7–60 primary filter with maximum transmission at 380 $m\mu$ for the incident light beam, and a 5–60 secondary filter with maximum transmission at 415 $m\mu$ for the reflected light beam.

10 mv recorder and seawater pump giving *ca.* 1 liter/min.

300-watt heat exchanger with a ± 0.1 C temperature control.

Bubble trap constructed from glass tubing sealed to a small reservoir so that bubbles from the intake water can escape before entering the fluorometer.

D. EXPERIMENTAL

PROCEDURE

1. Assemble the apparatus so that sea water is pumped through the bubble trap, heat exchanger, and flow-through cuvette. Adjust the temperature of the heat exchanger to prevent any condensation occurring on the cuvette. (15–18 C is generally satisfactory.)

2. Pump membrane-filtered (0.22μ) distilled water through the apparatus with the window opening set at maximum sensitivity (i.e. $\times 30$). Zero the fluorometer with the zero adjustment on the instrument. The recorder should be zeroed separately and then attached to the fluorometer.

3. Disconnect the distilled water reservoir and connect the pump to a seawater supply (*see Note below*). The instrument will record turbidity on a relative scale which can be made more, or less, sensitive by use of the four windows on the instrument (i.e. $\times 30$, $\times 10$, $\times 3$, and $\times 1$).

Note: On most research vessels a seawater loop brings water directly into the laboratory. This can be used to supply the instrument directly but a measure should be obtained of the time lag between the vessel's position when the sample is collected and when the turbidity is measured by finding the flow rate of water through the instrument.

E. CALIBRATION

It is difficult to standardize the instrument and its major use should be to locate particle concentrations which can then be studied by more absolute techniques. However in certain cases, such as when the instrument is being employed to investigate specific types of particulate material of a relatively uniform nature (e.g. silt), the instrument can be standardized to give a relationship between the load of material present and the degree of scattering. In this event the instrument must be standardized experimentally by determining the concentration (as the dry weight of filtered particles per unit volume) for several measurements of scattering.

PART V. PHOTOSYNTHETIC RATE MEASUREMENTS

V.1. INTRODUCTORY REMARKS

The subject of marine photosynthesis and its measurement is becoming highly complicated and cannot be discussed in any detail in the present manual. The topic has been reviewed fully by Strickland (Measuring the Production of Marine Phytoplankton, *Bull. Fish. Res. Bd. Canada*, No. 122, 1960) or, more recently, the chapter by Strickland (Riley and Skirrow [ed.] *Chemical Oceanography*, Academic Press, 1965) and the review of Eppley and Strickland (M. Droop [ed.] *Advances in Microbiology of the Sea*, Vol. I, Academic Press, 1968).

The bulk of marine photosynthesis is by microscopic phytoplankton, a sample of which can be enclosed in a small glass bottle. If photosynthesis (or respiration) occurs the oxygen and carbon dioxide content of the water in the bottle will change and it is by measuring these changes that the rate of photosynthesis is determined. Generally, changes of carbonate concentration are too small for convenient measurement but by adding the radioactive isotope of carbon, as carbonate, the uptake of carbon dioxide by phytoplankton may be estimated with adequate sensitivity. Such a technique has, in fact, a much greater sensitivity than the one based on the measurement of oxygen and has at last made it possible to measure photosynthesis in oligotrophic tropical oceans (Nielsen, *J. Conseil, Conseil Perm. Intern. Exploration Mer*, 18: 117, 1952). Unfortunately some doubt exists as to the interpretation of measurements made by this method. Because of the participation of intracellular carbonate in photosynthesis and the rapid excretion of ^{14}C -labelled organic matter, results by the radioactive carbon method will not necessarily measure gross or even net photosynthesis. It is generally assumed that in open ocean waters, where the method is most useful, a measurement approximating net photosynthesis is obtained. The true result may be higher or lower according to circumstances but experimental values are certainly of the correct order.

Apart from the interpretation of radiocarbon data there are many other considerations. The illumination of samples is important. Some workers suspend bottles containing phytoplankton in the sea, attached to a line from a buoy; others prefer to remove samples from various depths in the sea and place them in a "light incubator" where they may be illuminated for a known time at a fixed light intensity. The response of various species of planktonic algae to light varies greatly and is a function of the history of illumination of the plant cells. The photosynthetic activity of phytoplankters, under otherwise constant conditions, changes with the time of day, displaying a diurnal periodicity.

All these subjects are dealt with by Strickland in the references mentioned above and in the present manual we will give methods only for measuring growth and the photosynthesis that has occurred in a BOD bottle during a period of illumination. The origin of the sample, the nature of its illumination, and the interpretation

of results are left to the analyst but certain operations are common to all experiments in marine photosynthesis and may be conveniently standardized and described along with other methods of seawater analysis.

Rates of photosynthesis can be expressed in many ways. In the two methods which follow the unit used will be milligrams of carbon taken up (as a result of *photosynthetic* processes) in a cubic meter of sea water in 1 hr: mg C/m³ per hr.

The terms *gross* and *net* are used in conjunction with photosynthesis measurements to distinguish between the gross true synthesis of organic matter resulting from exposure to light and the net formation of organic matter that is found after allowance has been made for the respiration and other losses that occur in a plant cell simultaneously with the photosynthetic processes.

The photosynthetic quotient (PQ) and respiratory quotient (RQ) are dimensionless numbers indicating the relative amounts of oxygen and carbon involved in the processes of photosynthesis and respiration.

$$PQ = \frac{+\Delta O_2}{-\Delta CO_2} = \frac{\text{Molecules of oxygen liberated during photosynthesis}}{\text{molecules of carbon dioxide assimilated}}$$

$$RQ = \frac{+\Delta CO_2}{-\Delta O_2} = \frac{\text{molecules of carbon dioxide liberated during respiration}}{\text{molecules of oxygen consumed}}$$

A new method for estimating growth rates has been added to this edition. This technique, measuring changes of the volume of the particulate matter, has certain advantages; however, it is suitable only for productive waters and has not yet received such rigorous field testing as have the oxygen or radiocarbon methods.

V.2. CHANGES OF DISSOLVED OXYGEN (Photosynthesis by the "light and dark bottle" method)

METHOD

A. CAPABILITIES

Range: 3–200 mg C/m³ per hr

This range depends somewhat on the time used for illuminating samples but the above encompasses the limits obtainable by good experimental practices.

1. PRECISION AT THE 100 MG C/M³ PER HR LEVEL

The correct value lies in the range:

Mean of n determinations $\pm 15/n^3$ mg C/m³ per hr (6 hr incubation).

2. PRECISION AT THE 10 MG C/M³ PER HR LEVEL

The correct value lies in the range:

Mean of n determinations $\pm 1.5/n^3$ mg C/m³ per hr (6 hr incubation).

These precision limits apply to work on aliquots from a single large sample and do not include variabilities from sampling. Much depends upon the duration of the experiment and the nature and uniformity of the illumination used. The above limits are probably the widest to be expected from careful experimentation.

3. LIMIT OF DETECTION

This again will depend upon conditions, populations and the duration of experiments but a practical lower limit for the method is probably around 2–3 mg C/m³ per hr.

Note: In all cases a greater precision is possible with oxygen determinations *per se* (see Part I.3) than is implied above, but other manipulative errors are involved in the present method.

B. OUTLINE OF METHOD

The increase of oxygen arising from photosynthesis is measured in a BOD bottle containing a sample of the water under study. At the same time, the decrease of oxygen in a darkened bottle is used to measure any respiration occurring simultaneously with photosynthesis. The method of Part I.3 is used for both determinations. The means of illumination and the interpretation of results are not considered in the present method.

C SPECIAL APPARATUS

See Part I.3, Section C. In addition to clear BOD bottles a supply of totally opaque BOD bottles is required. Bottles should be painted black and then coated with overlapping strips of black Scotch tape. The top portions of the stoppers should be painted black and covered with tape. As a final precaution the entire bottle, or certainly the stopper and neck, should be wrapped in aluminum foil.

If BOD bottles are to be suspended in the sea they should have the stoppers wired in place. This is conveniently accomplished by winding stainless steel or

chrome-nickel wire (*not copper*) around the neck of the BOD bottle and making a loop that can be pushed tightly over the top of the ground-glass stopper.

All BOD bottles should be filled with chromic-sulphuric acid cleaning solution and allowed to stand for several hours before rinsing *very thoroughly* with distilled water. After a determination the acid iodine solution (*see later*) should be kept in the bottles until they are again needed. After every few weeks of use the bottles should be recleaned with chromic-sulphuric acid cleaner.

Small sacks of black cotton cloth are useful for covering BOD bottles to lessen unwanted photosynthesis whilst samples are being taken to and from their final location of photosynthesis. A series of suitably designed lighttight carrying cases will be found advantageous.

D. SAMPLING PROCEDURE AND SAMPLE STORAGE

Samples for photosynthetic measurements must *not* be *pumped* from the euphotic zone. The collection of samples is very important and only an all-plastic or glass bottle should be used. A 5-liter Lucite or Uscolite Van Dorn sampling bottle is recommended. The metal parts of this bottle must be made of stainless steel.

Ideally three separate determinations should be made on every sample, each determination in duplicate, necessitating a sample volume of 2–2.5 liters. The minimum sample volume that can safely be used is 1.5 liters. Samples should be transferred to polyethylene bottles with spigots coming from the base or fitted with a syphoning device of plastic tubing. They should not be stored for more than 1–2 hr and should be kept at sea temperature.

It is desirable to remove the larger zooplankton from samples by filtering them through clean nylon netting. The mesh size to use depends upon the size of the phytoplankters but generally 0.3-mm net will retain a negligible amount of phytoplankton when a few liters of sea water is poured through and often the mesh size can be reduced to 0.15 or 0.10 mm.

E. SPECIAL REAGENTS

See Part I.3, Section E, for reagents 1, 2, 3, and 4.

F. EXPERIMENTAL

PROCEDURE

1. The sample for analysis, in a 2- or 5-liter stoppered polyethylene bottle, is allowed to stand for 15–30 min at a temperature slightly higher than sea temperature and shaken occasionally to ensure the absence of any oxygen supersaturation (Note *a*).

2. Fill BOD bottles with the sample in subdued light, taking all the precautions described in Part I.3, Section D, paragraph 1 (Note *b*). Ideally only one clear BOD bottle (called hereafter LB) and one opaque bottle (called hereafter DB) need be filled but it is strongly recommended that, where possible, duplicates be analysed to ensure the detection of gross errors and to improve the overall precision of the technique. (n^2 in Section A will then equal 1.41.) If a result for both net photosynthesis and for respiration is required (*see later*) fill a third clear bottle (called hereafter IB), preferably in duplicate.

3. Place all bottles in their black sacks and storage boxes until ready for "incubation" at the desired location (in the sea or in a constant illumination incubator, etc.). As soon as the photosynthesis experiment is commenced add manganous sulphate and alkaline iodide solution (Part I.3, Section F, paragraph 1) to any IB bottles.

4. After a suitable period for photosynthesis and respiration to take place (Note *c*) remove the LB and DB samples and, without delay, add manganous sulphate and alkaline iodide as described above.

5. Continue the analysis exactly as described in Part I.3,F, paragraphs 2-5, finding the value for the amount of oxygen in each bottle in terms of milliliters of thiosulphate of factor *f*. Use a 50-ml aliquot of iodine solution for titration. For the most precise work titrate duplicate 50-ml aliquots and find a mean titration volume of thiosulphate. Let V_{LB} , V_{DB} , and V_{IB} be used to designate the thiosulphate titrations obtained with the three types of bottle described in paragraph 2 above. If *N* is the number of hours during which LB samples were exposed to light, the DB samples being held at the same temperature as the LB samples, then:

$$\text{Gross photosynthesis, mg C/m}^3 \text{ per hr} = \frac{605 \times f \times [V_{(LB)} - V_{(DB)}]}{N \times PQ}$$

$$\text{Net photosynthesis, mg C/m}^3 \text{ per hr} = \frac{605 \times f \times [V_{(LB)} - V_{(IB)}]}{N \times PQ}$$

$$\text{Respiration (Note } d), \text{ mg C/m}^3 \text{ per hr} = \frac{605 \times f \times [V_{(IB)} - V_{(DB)}] \times RQ}{N}$$

The best value for PQ and RQ to use in these equations is left to the discretion of the analyst. With normal marine populations exposed to moderate light intensities a photosynthetic quotient of 1.2 and a respiratory quotient of 1.0 is suggested.

NOTES

(a) Supersaturation of samples with respect to dissolved oxygen is a common occurrence in many fertile inshore sea areas in the spring and summer. Unless the water in the BOD bottles is in equilibrium (or preferably slightly undersaturated) with respect to oxygen, very serious errors can occur because of losses of oxygen by physical causes. This applies especially to samples taken from below the surface. Shaking solutions vigorously at intervals for about 30 min whilst they are warmed to a few degrees above sea temperature has been found to be satisfactory but if very high rates of photosynthesis are anticipated it may be best to pass a little air or clean nitrogen gas through the sample until it is 10-20% undersaturated in respect to oxygen.

(b) It is most important, especially when attempting to measure relatively small rates of photosynthesis, that the oxygen content is exactly the same in LB, DB, and IB samples. For surety if a large number of bottles are to be filled from one source of sample an IB bottle should be set aside for every five or six BOD bottles filled. This acts as a check on the oxygen level in the water.

(c) The time of incubation is left to the discretion of the analyst. In general at least 3 hr should be allowed, even in the richest waters. There is nothing to be gained by prolonging incubation beyond 24 hr. Errors due to the respiration of small zooplankton and bacteria then become serious.

(d) The respiration measured by this expression is not necessarily the respiration due to plant cells alone. A substantial fraction of the recorded value may arise from zooplankton and bacteria. The assumption that the same rate of respiration occurs in the LB as the DB, which is the basis of the above calculation of *gross* photosynthesis, has been challenged and is undoubtedly incorrect if experiments are unduly prolonged. The subject is too complicated to be discussed here and the reader is referred to "Measuring the Production of Marine Phytoplankton" by Strickland (*Bull. Fish. Res. Bd. Canada*, No. 122, 1960).

(e) It must be remembered that the mean rate of photosynthesis measured by the L and DB method (or other techniques) is not the same as the true rate of photosynthesis measured by the differential dp/dt . If p_t is the amount of fixed carbon at time t and p_o the amount at a zero reference time, t_o , then the rate as measured experimentally is

$$\frac{p_t - p_o}{t} = \frac{D}{t}$$

where D is the increase of carbon found in the LB. If plant growth is approximately exponential the true rate at time t_o is given by the expression

$$\frac{dp}{dt} = \frac{p_o}{t} \times 2.3 \log \frac{D + p_o}{p_o}$$

which necessitates a knowledge of p_o for its calculation. p_o is rarely known.

If the fractional increase of plant material does not exceed about 20% during an experiment the true rate at zero time, dp/dt is equal to D/t to within a few per cent. The true rate at a time $(t - t_o)/2$, however, is still close to the value for D/t with D as much as p_o (that is, when the population has doubled). For most experiments with marine phytoplankton the time of an experiment should therefore not exceed about 2-3 hr if we wish to find dp/dt at t_o or 10 hr for an estimate of dp/dt at time $(t - t_o)/2$.

G. DETERMINATION OF BLANK

For the determination of any reagent blank see Part I.3, Section G.

H. CALIBRATION

For the calibration of thiosulphate see Part I.3, Section H.

V.3. UPTAKE OF RADIOACTIVE CARBON

INTRODUCTION

The following method is given for workers who wish to use the radioactive carbon technique as a research tool or who have other reasons for carrying out the method entirely without external assistance. For others there already exists a service for providing 4- μ c carbon-14 sources, filtration equipment, holders, etc., with facilities for counting and standardizing the radioactive plankton samples obtained as a result of a photosynthetic rate experiment. Details and prices can be obtained from the Danish Institute for Fisheries and Marine Research, Charlottenlund Castle, Denmark. Working Group 20 of the UNESCO Scientific Committee on Oceanic Research has recently issued a report of recommendations for the radiocarbon estimation of primary production which should be consulted.

METHOD

A. CAPABILITIES

Range: 0.05–100 mg C/m³ per hr

The range of this method depends very largely on the amount of radioactive carbon added and the precision of the radiochemical part of the procedure. There is virtually no upper limit and the lower limit could probably be reduced to 0.01 mg C/m³ per hr by using great care. An absolute lower value will exist, however, depending upon the reproducibility of "dark blanks" (*see later*). The above range is a realistic one under routine conditions.

1. PRECISION AT THE 25 MG C/M³ PER HR LEVEL

The correct value lies in the range:

Mean of n determinations $\pm 3/n^{\frac{1}{2}}$ mg C/m³ per hr (5 hr incubation, 1 μ c added).

2. PRECISION AT THE 1.5 MG C/M³ PER HR LEVEL

The correct value lies in the range:

Mean of n determinations $\pm 0.15/n^{\frac{1}{2}}$ mg C/m³ per hr (7 hr incubation, 5 μ c added).

B. OUTLINE OF METHOD

A known amount of radioactive carbonate, $^{14}\text{CO}_3^{2-}$, is added to sea water of known total carbonate content. (The addition of inactive carbonate with the "labelled" material is negligible.) After photosynthesis by the endemic phytoplankton population has continued for a suitable period the cells are filtered onto a membrane filter, washed and dried, and the radioactivity from the carbon in the plants is measured with a suitable Geiger counter. This uptake of radioactive carbonate, as a fraction of the whole, is assumed to measure the uptake of total carbonate, as a fraction of the whole, and hence the rate of photosynthesis may be evaluated.

C. SPECIAL APPARATUS

BOD bottles (clear and opaque) cleaned, etc. as described in Part V.2, Section C.

Small sacks of black cloth and lighttight boxes as described in Part V.2, Section C.

The 25-mm diam Millipore filtration apparatus should be fitted with a funnel to hold more than 300 ml of liquid. A manostat device (there are several cheap commercial laboratory models based on the Cartesian diver) set to regulate the suction to the filtration unit to prevent the vacuum becoming greater than 150–200 mm of mercury.

A Geiger counter and decade scaler. It is strongly recommended that an ultra-thin end-window flow-counter be used rather than a windowless model. There is only a slight decrease in sensitivity with the former and the reliability and ease of use is greatly improved. In many sea areas it is difficult to filter the entire contents of a 300-ml BOD bottle through 25-mm filters, as described below. Although aliquots can be taken it is preferable to filter the entire contents of the bottle. If a counter accepting 50-mm planchettes is available it should be used as then samples can be filtered on 47-mm HA Millipore filters which are counted after mounting on a suitable copper or aluminum planchette. A pair of metal forceps for handling planchettes, and suitable tongs for placing holders in and out of the counter are required.

A 2-ml capacity "insulin" syringe with a supply of hypodermic needles, 2 and 6 inches long.

Cylindrical cardboard pill boxes with one or two small perforations in the lid, for storing copper planchettes and filters.

A desiccator containing small sacks of silica gel and soda lime to ensure a dry carbon dioxide-free atmosphere.

D. SAMPLING PROCEDURE AND SAMPLE STORAGE

The general sampling methods and precautions specified in Part V.2 apply equally well to the present method. However, less sample is required (ideally two clear and one dark BOD bottle per sample) and it is unnecessary to ensure that there is no oxygen supersaturation. Subsurface samples should never be exposed to full sunlight during the filling operation or else "sun damage" of the phytoplankton cells may occur.

E. SPECIAL REAGENTS

1. NEUTRAL FORMALDEHYDE SOLUTION

Take good quality 40% formaldehyde solution and decant the clear liquid from any precipitate. Store the solution in a well-stoppered dark glass bottle to which have been added a few small calcium carbonate (marble) chips.

2. FILTERED SEA WATER

As a wash liquid use sea water taken at the same time as the samples and filtered through an AA Millipore filter. Do not use synthetic sea water or a sodium chloride solution.

3. NITRIC ACID WASH SOLUTION

Prepare approximately 30% v/v solution of the concentrated acid. Add about 1 g of sulphamic acid or urea to each liter.

4. RUBBER CEMENT

Use a good quality *thin* rubber cement of the type prepared commercially for office use.

5. RADIOACTIVE CARBONATE SOLUTION

a. Sodium chloride dilution solution

Prepare 5% w/v sodium chloride solution from the analytical quality salt and distilled water. Add 0.3 g of anhydrous sodium carbonate, Na_2CO_3 , and 1 pellet (ca. 0.2 g) of sodium hydroxide to each liter of this solution. Many liters may be required.

b. Stock solution of active carbonate

Obtain a "carrier free" solution of $\text{Na}_2^{14}\text{CO}_3$ (generally in the presence of a trace of sodium hydroxide) with an activity of about 0.5–1 mc/ml. The activity, correct to about 10%, should be stated by the manufacturer.

c. Working solutions

Prepare suitable quantities (at least 2 liters at a time is recommended) of dilute radiocarbon solutions by diluting the stock solution of active carbonate with the sodium chloride dilution solution. These working solutions should be prepared *immediately* before ampules are filled (*see below*) and care must be taken when handling the stock radioactive carbonate solution to see that none of it touches the hands or mouth or contaminates the benches of the laboratory in which subsequent work with radioactive carbon is to be carried out. Work over a large enamel tray covered with paper towels to catch and absorb any drips. Ordinary volumetric glassware may be used in this dilution operation but should be rinsed very thoroughly with acid and with distilled water after use. Use some form of automatic sucking device with pipettes.

Prepare one or more working solutions having the following *nominal* strengths (assuming the activity assay of the initial carbonate solution by the supplying agency is approximately correct):

2 ml \equiv 1 μC (microcurie) of ^{14}C

2 ml \equiv 5 μC (microcuries) of ^{14}C

2 ml \equiv 25 μC (microcuries) of ^{14}C

Generally speaking only one or two of these stock working solutions will be required by any one establishment (*see Section F*).

d. Stock ampules

Use 2-ml soft glass ampules. Fill each ampule with exactly 2.00 ml of radioactive working solution, using an "insulin" syringe with a 2-inch hypodermic needle or some suitable semiautomatic filling device. Ensure that no drops of solution collect at the mouth of the ampules and seal each one in a low-temperature blow-pipe. Autoclave the ampules, submerged in a strongly coloured aqueous solution of

methylene blue, at 15 psi of steam for at least 20 min. Cool and remove the ampules, discarding any which are defective, as indicated by blue solution's having entered through the glass.

The preparation of dilute working solutions (*c above*), the filling and sealing of ampules, and the autoclave sterilization operation should be carried out on the same day. Working solutions are then stable almost indefinitely. They are standardized as to their exact content of radioactivity by the method to be described in Section H.

F. EXPERIMENTAL

PROCEDURE

1. The sample for analysis is poured into a clear BOD bottle (preferably in duplicate) leaving an air space of about 3–5 ml at the top of the bottle (Note *a*).

2. Take an ampule containing 2.00 ml of suitable strength radiocarbon solution in 5% sodium chloride (Note *b*), score the tip with a sharp glass file and break it off. Carefully suck out the entire contents of the ampule by an "insulin" syringe fitted with a 6-inch hypodermic needle, transfer the needle to the *bottom* of the BOD bottle, and empty the contents of the syringe *slowly* into the sample. Raise the needle to the top of the BOD bottle, remove about 2 ml of sample and use this to rinse the ampule. Finally suck the ampule dry again and squirt the rinsing back into the BOD bottle. Add a little saline wash solution (if necessary) to fill the bottle, and close it with its ground glass stopper which should be secured by wire (Note *c*). The operations described in this paragraph should be carried out on a large paper-covered tray remote from the part of the building or laboratory in which the subsequent counting of radioactive plankton is to be carried out (*see later*).

3. Mix the contents of the BOD bottle thoroughly by shaking, cover it with a black sack, and put it into a lighttight box. When all samples have been "inoculated" expose them to illumination for a suitable time for photosynthesis to occur (Note *d*).

4. At the end of the experiment remove the stopper from the BOD bottle and add 1 ml of neutral formaldehyde solution from a small hypodermic syringe kept specifically for this purpose (Note *e*).

5. Assemble the filtration apparatus with a plain white 25-mm HA Millipore membrane filter in place. Filter the entire contents of the BOD bottle through the membrane, sucking it dry (Note *f*). Rinse the sample bottle twice with about 10-ml portions of filtered sea water, scrubbing the sides and bottom of the bottle with a rubber policeman, suck each washing through the membrane and finally wash the filter funnel and membrane with two or three more small rinses (2–4 ml) of filtered sea water. Suck the membrane free from all excess liquid, remove the source of vacuum, and unclamp the funnel (Note *g*).

6. Using clean uncontaminated forceps remove the membrane disc holding the radioactive plant cells and roll it onto a copper planchette previously smeared with rubber cement (Note *h*). Place the planchette holding the sample into a numbered pillbox and store the pillbox in the desiccator. Samples should be allowed to dry and lose their rubber cement solvent for at least 2 hr before being counted and may be stored for as long as several weeks if necessary (Note *i*).

7. Place the planchette and sample into a suitable Geiger counter assembly and measure the radioactivity. Details of this operation are not given as they depend largely on the equipment used but at least 5000, preferably 10,000, counts should be recorded for each sample. (Notes *b* and *j*). "Normalize" all counting rates to the rate found with a standard source, checked at least once a day or more frequently according to the stability of the counter system (Section H.2 (*i*)). Let R_s be the normalized counting rate (in counts per minute) of the sample planchette (Notes *k* and *l*), let R_b be the normalized counting rate of a blank determined as described in Section G, and let R be the normalized counting rate to be expected from the entire activity of the ampule. R varies with the microcurie level in the ampules and is determined as described in Section H.

8. Determine the total carbonate contents of the water by Part I.4. In nearly all sea locations, except in areas of excessive land drainage, it is only necessary to know the chlorinity and *pH*. The assumption of a specific alkalinity of about 0.125 and a density of 1.025 is made for calculation of the total alkalinity (*see* Part I.4.I.2). The *pH* of the sea water should be known in order to make the correction in Table VIII but the assumption of *pH* 8.0 is probably adequate in most cases. If A is the total *carbonate* alkalinity in milliequivalents per liter, calculate the weight W of carbonate carbon present in the water in mg C/m³ by the relation:

$$W = 12,000 \times A \times F_T$$

where F_T is read from Table IX and may generally be approximated to 0.95.

9. If N is the number of hours during which the sample was exposed to light, then the rate of photosynthesis is given by

$$\text{Radiocarbon-measured photosynthesis (mg C/m}^3 \text{ per hr)} = \frac{(R_s - R_b) \times W \times 1.05}{R \times N}$$

The factor 1.05 is put in to allow for the fact that the carbon-14 isotope behaves rather differently from the carbon-12 isotope found in nature. This correction is somewhat uncertain.

NOTES

(*a*) A small air space should be left so that the contents of the bottle do not overflow when the radioactive solution is added. This precaution lessens the chances of contamination of the laboratory and personnel with radioactive solution.

(*b*) The amount of radioactivity to add depends upon the photosynthetic potential of the water, time of incubation, etc. If E is the percentage efficiency of the counting assembly used (generally 25–50), U the anticipated uptake of carbon in mg C/m³ per hr (say a tenth of the daily photosynthetic production rate), and R_s is the desired number of counts per minute from the radioactive plankton after an illumination period of N hr, then:

$$\mu\text{c (microcuries) carbon-14 to be added} = \frac{R_s}{E \times U \times N}$$

As R_s should be at least 1000 count/min and N is generally about 5 hr it will be seen that 25- μc ampules should be used for most open ocean work, 5- μc for moderately productive inshore waters, and 1- μc ampules for work in coastal areas during a phytoplankton bloom.

Making up the radiocarbon solution in 5% sodium chloride ensures that it is denser than all

seawater samples and sinks to the bottom of the BOD bottle when it is added. The final electrolyte strength and composition of the sample are not materially affected.

(c) The bottle should be filled completely to minimize leakages and exchange when the BOD bottle is placed in a light incubator or, more particularly, at depth in the sea. The introduction of a little filtered sea water does no harm. As long as a known amount of activity is added to a bottle of sea water and *all* the water is filtered the present method is *not* affected by the volume of the water initially in the bottle.

(d) The illumination period should not exceed 10 hr and should preferably be between 2 and 6 hr.

(e) Organisms are killed and photosynthesis is stopped by this addition. From then on samples may be exposed to light whilst they are filtered, etc., without introducing error, but filtration should not be delayed for more than a few hours. If filtration can be carried out in subdued light immediately after a sample has been incubated and if the filtration time does not exceed a few minutes the formaldehyde addition should be omitted. Even in the small concentrations used here formaldehyde may affect the excretion or loss of organic matter from the more delicate algae and should not be used for the most precise work. However, when a large batch of samples has to be filtered the errors brought about by not killing the algae will probably be greater than those introduced by this treatment, especially when bottles cannot be conveniently stored in total darkness or the filtration cannot be carried out in very subdued light.

(f) Filtration should be rapid and the time should not exceed about 10 min. However, with samples having large population densities or containing clay particles, filters will clog rapidly and nothing is to be gained by greatly increasing filtration times. Either take an aliquot from the BOD bottle (check that the volume is 300 ml) or filter the water through a 47-mm diam filter. In the latter case count the whole filter or cut a small disc from the stained portion with a sharp cork borer and multiply the resulting count by a factor which is the ratio of the area of the stained part of the filter to the area of the cut disc. Occasionally with heavy coastal blooms the plankton on the filter from 300 ml will not be "weightless" (less than about 0.1 mg/cm²). If the chlorophyll *a* content of the water exceeds about 10 mg/m³ use a 47-mm filter or take only a 100-ml aliquot from bottles. It has been shown that not all the radioactivity in a seawater sample is retained even by an HA porosity filter (*ca.* 0.5- μ pore-size) if samples are filtered with full suction from a water pump. Losses depend on populations, etc., but are greatly reduced or eliminated if the suction is regulated so that it never exceeds about $\frac{1}{4}$ - $\frac{1}{3}$ atm.

(g) Washing with isotonic sodium chloride solution (*ca.* 3-4%), as previously recommended, has been shown to give a loss of radioactivity. Use only filtered sea water from the location of the samples. If filters are sucked dry only a very small washing is necessary. Various treatments of the filters by acid have been recommended to remove the inorganic labelled carbon taken up as carbonate. The amount of this uptake is still in question but can only be significant if the phytoplankton contains an appreciable proportion of coccolithophores. For most coastal samples no acid treatment is necessary. If coccolithophores are suspected hold the filter with bone-tipped forceps in the mouth of a flask containing concentrated hydrochloric acid and bathe the filter in the moist hydrogen chloride vapour for about 0.5-1 min before attaching it to the planchette. A washing with dilute acid solution is *not* recommended.

(h) The analyst should not touch planchettes or filter membranes by hand and should give his hands a thorough wash in water at this stage for safety, in case small amounts of radioactive sample solution contaminate the planchette.

(i) Planchettes may be stored for several weeks before counting, if adequately protected from physical damage, but we are not certain of the upper limit of storage time. If the pillboxes are stored in a desiccator having both a dry and carbon dioxide-free atmosphere there seems little reason to suppose that counting could not be delayed for many months.

(j) A suitable activity for the radioactive carbonate solution has been discussed in Note *b*. The standard deviation of any radiochemical determination is ultimately limited by the properties of radioactive atoms, as the coefficient of variation can not be less than $100/(R_s \times t)^{\frac{1}{2}}$ where R_s is the number of counts per minute and t the time of counting. For the precision to be $\pm 2\%$ or better from counting statistics alone the total number of counts must therefore exceed

10,000. As t should not have to exceed 5–10 min for practical reasons R_s should be at least 1000 count/min.

(*k*) The natural background count of the Geiger assembly should not exceed about 20–40 count/min and should be reproducible from day to day. In most circumstances this count is allowed for in the blank determination R_b obtained as described in Section G, but if there is reason to suppose that the natural count will change much in between measuring R_s and R_b , each rate should be corrected separately for natural background before they are used as in paragraph 9 of Section F. Care must be taken to see that “coincidence corrections” are made if the counting rate of a sample becomes too great for the Geiger assembly. With most equipment this critical rate lies between 5,000 and 10,000 count/min and the analyst is referred to textbooks on radiochemistry for particulars.

(*l*) One should be on guard that the self absorption of the radioactive material on the planchette does not become sufficiently great to cause errors. This will be rarely the case in open ocean waters. In coastal areas, especially in the presence of suspended mineral matter, the amount of material on the filter may exceed 0.05 mg/cm² if too much sample is filtered and thus cause an error. Even with “weightless” sources, there is evidence that the efficiency of counting depends on the plankton species that have been filtered (C. Goldman, *J. Conseil, Conseil Perm. Intern. Exploration Mer.* In Press at the time of writing). This source of variability is not generally appreciated. The errors introduced by assuming a constant efficiency will generally not exceed 10% and can be accepted for most ecological work but for the specialized studies, where a high precision and accuracy is sought, end-window geiger counting should be replaced by the use of a scintillation counter.

G. DETERMINATION OF BLANK

Even in total darkness there is some uptake of radioactive carbon by plants, animals, and bacteria, largely by “exchange,” although there may be a little true fixation. The amount depends mainly on time and is generally only 1–2% of the photosynthesis over a comparable period but in some ocean samples, especially in the tropics, the fraction may be 10% or greater. In any case the determination is worth making and acts as an overall safeguard against serious errors being undetected.

Fill a blackened BOD bottle with the sample and treat it exactly as described in Section F, paragraphs 1–7, placing the bottle near to the sample bottle (hence at the same temperature) during the illumination period. The final activity, R_b , may only be a few counts per minute greater than the natural background and a total count of 5,000–10,000 is clearly *not* warranted. The most suitable counting period is left to the discretion of the analyst.

As only a few per cent of the total activity in a BOD bottle will be taken up by plants the contamination of planchettes, etc., by only a trace of radioactive seawater sample will cause serious errors. The “inoculation” of BOD bottles from ampules and the filtration of samples should preferably be carried out in a part of the laboratory away from where planchettes are mounted and counted. BOD bottles and filtration equipment must be rinsed thoroughly with distilled water after use. From time to time all glassware and planchette holders should be rinsed in nitric acid wash solution and then water. Copper planchettes, with adhering membrane filters, should be discarded when counting is completed but pillboxes may be used again.

H. CALIBRATION

Note: The calibration of this method is the most critical step. The following “classical” procedure has been repeated from earlier editions for the use of laboratories where scintillation

equipment, etc., is not available but we do not recommend its use. We believe the only satisfactory method is to determine the absolute disintegration rate of the source using a scintillation counter and the efficiency of the end-window counter by counting membranes holding radioactive phytoplankton and subsequently finding their absolute disintegration rates (*but see* Section F, Note 1). The counting rate of an ampule, R , will then be the efficiency of the counter (20–50%) multiplied by the disintegration rate of the material in an ampule and should be “tied” to a standard source as described in H.2.(i) below. Eventually the entire radiocarbon method will be done by scintillation counting when this equipment is generally available. For details see Wolfe and Schelske (*J. Conseil, Conseil Perm. Intern. Exploration Mer*, 31: 31, 1967).

1. SOLUTIONS REQUIRED

a. *Radioactive working solutions*

Take two or more ampules *at random* from the stock prepared as described in Section E.5. If several strengths of solution are to be prepared and analysed it is often convenient to prepare the weaker activity solutions by exact volumetric dilution of the strongest solution used. In this way direct calibration is necessary only for the most strongly active solution and the other values may be obtained by simple arithmetic.

b. *Carbonate solution*

If A is the area (in cm^2) covered by the solid filtered onto a membrane filter by the equipment used, dissolve $0.54A$ g of anhydrous sodium carbonate, Na_2CO_3 , in 1000 ml of distilled water.

$$1 \text{ ml} \equiv 1 \text{ mg BaCO}_3/\text{cm}^2$$

c. *Barium hydroxide solution*

Boil 1 liter of distilled water for a few minutes to remove dissolved carbon dioxide and then add 10 g of analytical reagent quality barium hydroxide, $\text{Ba}(\text{OH})_2 \cdot 8\text{H}_2\text{O}$. Allow the solution to cool in an aspirator or similar vessel with a carbon dioxide trap. Any fine precipitate will settle out in a day or so and the clear supernatant solution should be used. This reagent must be kept out of contact with atmospheric carbon dioxide until immediately before use.

d. *Ammonium chloride solution*

Dissolve 5.0 g analytical reagent quality ammonium chloride in 500 ml of distilled water.

e. *Wetting agent*

Prepare a 0.2% solution of a stable neutral detergent.

2. STANDARDIZATION (DETERMINATION OF R)

(a) Remove the active solution from an ampule with an “insulin” syringe and transfer it to a volumetric flask containing one or two pellets (0.2–0.5 g) of sodium hydroxide. Rinse the ampule and hypodermic syringe once or twice with a little water and make the solution to a suitable volume such that 1 ml of the resulting solution contains about $10^{-2} \mu\text{C}$ of activity. Secondary dilutions may be necessary; e.g., 2 ml of $25\text{-}\mu\text{C}$ solution is made to 100 ml and 10 ml of the resulting solution is rediluted to 250 ml, whence 1 ml contains $10^{-2} \mu\text{C}$. It is well to prepare exactly similar replicate dilutions from a further one or two ampules. These dilute solutions

should be used within a few hours of preparation. The initial flask and other flasks used to make secondary dilutions must contain a little sodium hydroxide to prevent the exchange of labelled carbon dioxide and atmospheric carbon dioxide above the solutions. This can be very serious with large solution-air interfaces unless solutions are appreciably alkaline (as could be the case if only distilled water were used for these dilutions). Flasks must be filled *immediately* to the neck after adding the radioactivity.

(b) Add to one or more 100-ml beakers (fitted with rods and coverglasses) 2.00-ml aliquots of the diluted radioactive standards, using an "insulin" syringe. Add about 5 ml of ammonium chloride solution and pipette in 20 ml of sodium carbonate solution. Make the volume to about 50 ml with recently boiled-out distilled water and add 20 ml of barium hydroxide solution slowly, stirring solution as this reagent is added. Add about 5 drops of wetting agent (the exact amount must be found by trial and will depend upon the detergent used) and allow the precipitate to settle for about 15 min, with the coverglass in place. The detergent will prevent excessive "creep" of the precipitate.

(c) Place an HA filter and copper planchette on a holder (do *not* cement the filter) and dry the assembly for about 1 hr in a desiccator. Remove and weigh the assembly to the nearest $\frac{1}{10}$ mg.

(d) Assemble the filtration apparatus with the weighed HA filter in place and filter the suspension of barium carbonate. Remove all the carbonate from the beaker with the aid of a policeman, rinsing with a little distilled water. Suck the precipitate dry on the filter and wash it once or twice with *small* volumes of distilled water. Remove the HA filter holding the precipitate and place it onto the weighed copper planchette. Clamp the planchette and filter into the weighed holder but do *not* cement or lose any of the membrane filter in the process. The filtration assembly, beakers, etc., should be rinsed with nitric acid wash solution and water before re-use.

(e) Allow the assembled holder, planchette, filter, and precipitate to dry for at least 2 hr in a desiccator (check for constant weight) and finally reweigh to the nearest $\frac{1}{10}$ mg. Find the weight, in milligrams, of barium carbonate precipitate (containing all the added radioactive carbon) as the difference between this weight and the initial weight (paragraph (c) above). Measure the area of the precipitate in cm^2 .

(f) Find the radioactive count of the sample, using precisely the same assembly as that used for phytoplankton samples. Evaluate the counting rate in counts per minute, having counted a total of at least 10,000—preferably 50,000—counts. Correct this rate for any "coincidence correction" and for the natural background rate if this is significant.

(g) From the weight of precipitate per unit area and a self-absorption correction graph (*see 3 below*) find the standard count at *zero* thickness of precipitate. This count should be obtained (as a mean) from duplicate experiments on one dilute solution. Two or more dilute solutions are prepared from separate ampules. *R* is obtained by correcting these observed counts for self absorption and for the dilution factor necessary to relate counts back to the rate expected from the entire content of an ampule.

(h) Take a *standard source* of radiocarbon, having a counting rate of between about 2,000 and 10,000 count/min (such sources are obtainable commercially and their true counting rate, i.e. disintegrations per minute, are assumed not to change with time), and measure the exact rate on the same Geiger assembly as used above, counting at least 50,000 counts. Let this counting rate be R_c .

(i) The standard count R is then "tied" to the counting rate of the standard source R_c *obtained on the same day the calibration is made*. R need not be redetermined until a fresh batch of ampules is prepared as long as the standard source is unchanged and all sample counts obtained in the photosynthesis experiments (see Sect. F, paragraph 7) are "normalized" to the count R'_c . This is done by counting the standard source each day and finding a counting rate R'_c (which should be generally within a few per cent of R_c). Sample counts are multiplied by a factor R_c/R'_c before being used in calculations (Sect. F, paragraph 9), i.e.

$$R_s \text{ (Sect. F.7)} = \text{Rate found} \times R_c/R'_c$$

For counting equipment with 2π geometry R should be approximately 10^6 for each microcurie in the radioactive working solution in the ampules. R values are determined for each batch of ampules and refer to the count from the entire content of the ampule.

3. DETERMINATION OF A SELF-ABSORPTION CORRECTIVE CURVE

a. Introduction

The "soft" beta rays from ^{14}C are readily absorbed by matter. The absorption is largely a function of the "thickness" of the absorber (defined in radiochemical work as a mass per unit area, generally mg/cm^2) and is nearly independent of the type of matter comprising the absorbing material. Because of a near-cancellation of several effects the final absorption pattern of the beta rays is reminiscent of the attenuation of light through a uniform medium. It is evident, therefore, that a precipitate such as the one used above will partly absorb radiation from the ^{14}C atoms in the precipitate itself, giving rise to the phenomenon of "self absorption." The counting rate for a given amount of activity in a precipitate $20 \text{ mg}/\text{cm}^2$ "thickness," used for standardization, will be only about 10% of the count that would have been recorded if the same amount of radioactivity had been present on a filter with only a negligible amount of solid material on it, as is the case with phytoplankton filtered from a few hundred milliliters of sea water. To find the relationship between the counting rate determined on standards and the counting rate at "zero thickness" we must construct a self-absorption curve showing the *relative* counting rate of a fixed amount of radioactivity plotted (on the ordinate) against the thickness of the precipitate containing the radioactivity (on the abscissa). The shape of this curve is approximately (but by no means exactly) exponential and depends upon the radiochemical equipment and counting equipment used. The curve need only be determined *once* and is not required for the entire range of possible weights. One needs to be concerned only with the change of relative rate with weight of barium carbonate in the range $10\text{--}30 \text{ mg}/\text{cm}^2$, measured as a fraction of the counting rate at zero thickness. The latter is obtained by *extrapolation*, using successively smaller weights of barium carbonate.

b. *High-weight portion of graph*

Carry out the procedure described in Section H.2(b)–(f), finding the normalized corrected counts of precipitates containing the same amount of radioactivity (2.00 ml of active solution) with thicknesses of approximately 10, 15, 20, 25, and 30 mg/cm². These are obtained by adding 10, 15, 20, 25, and 30 ml of sodium carbonate solution to the beakers. It is desirable to carry out each determination in duplicate.

Count at least 10,000 counts for each sample. Construct a curve showing the count of each sample relative to the zero thickness count (*see c below*) against the thickness of each precipitate in mg/cm². Whenever standardization is carried out (as described in H.2 *above*) the count R is calculated from the relationship shown on this graph and a knowledge of the thickness (mg/cm²) of the standard (Sect. H.2(g)).

c. *Determination of zero-thickness count*

Prepare a set of twelve planchettes, holders, and HA filters; dry and weigh *two* as described in Section H.2(c). To a 250-ml beaker add 50.0 ml of the same dilute radioactive solution as was used in the “high-weight” experiments above, and about 25 ml of ammonium chloride solution. Pipette in 50 ml of sodium carbonate solution. Make the volume to about 150 ml with recently boiled-out distilled water and add 50 ml of barium hydroxide solution, stirring the solution as the reagent is added. Cover the beaker and allow the precipitate to settle for about 1 hr and then decant off most of the supernatant liquid *without* appreciable loss of precipitate. Add about 100 ml of distilled water, stir up the precipitate vigorously and again allow it to settle, and decant off the clear supernatant liquid. Finally transfer the solid quantitatively to a 250-ml volumetric flask and make to a volume of exactly 250 ml with distilled water. Shake the flask vigorously to suspend the solid uniformly and immediately pipette a 50-ml aliquot. Filter this aliquot of precipitate onto one of the weighed filter assemblies, dry in a desiccator, and reweigh. Repeat with a further aliquot from the thoroughly mixed suspension.

Place a small covered magnetic stirring bar in the flask of precipitate and whilst stirring vigorously pipette duplicate portions of 10, 5, 2, 1, and 0.5 ml of slurry directly onto membrane filters in the Millipore filtration equipment. A little water should be put in the filter funnel first and the aliquot of slurry added (rinse the pipette into the funnel) before applying suction. This ensures a more uniform dispersion of precipitate on the membrane filter. Dry the ten separate planchettes and precipitates thus obtained. Count each precipitate, “normalize” each count to the radioactive standard, and correct for “coincidence error,” natural background, etc. The counts found for the 10-, 5-, 2-, 1-, and 0.5-ml aliquots are multiplied by 1, 2, 5, 10, and 20, respectively, to make them comparable to the activity of the precipitates used in the “high-weight” experiments (*b above*). If W is the mean weight of the precipitate per unit area found from the 50-ml aliquot experiments (the activity of these precipitates does not have to be measured) then the weights per unit area corresponding to 10-, 5-, 2-, 1-, and 0.5-ml aliquots are 0.2 W , 0.1 W , 0.04 W , 0.02 W , and 0.01 W , respectively. Plot the corrected counts on a logarithmic scale against these thicknesses on an arithmetic scale. Extrapolate to zero

thickness by the best line, which should be approximately linear at thicknesses below about 1 mg/cm^2 . The count at zero thickness (about 10 times the count for the same amount of radioactivity in a precipitate of 20 mg/cm^2 thickness) is called unity and is used to fix the curve plotted in the high-weight experiment (*b above*), showing the self-absorption effect of samples having thicknesses between 10 and 30 mg/cm^2 .

V.4. GROWTH RATE OF SUSPENDED MATERIAL

INTRODUCTION

The light and dark bottle techniques described in the two previous sections (V.2 and V.3) can also be used in determining the growth rate of particulate material using any change in biomass as a measure of growth. For short time intervals, however, techniques for determining small changes in the biomass of material are in general not sufficiently sensitive to make such measurements. Over longer time intervals, some investigators have used the increase in plant pigment or carbon as a measure of growth. With natural populations, however, there is almost always a quantity of detritus present so that, even with such plant specific methods as chlorophyll *a*, any amount of detrital chlorophyll or its derivatives present at the beginning, or formed during the course of the growth period, will lead to erroneous determinations of the growth constant.

In a recent report by Cushing and Nicholson (*Nature*, 212: 310, 1966) a solution to the problem of determining growth rates of particulate material in the presence of detritus has been described. The following procedure is taken from Sheldon and Parsons, 1966 (*A Practical Manual on the Use of the Coulter Counter® in Marine Research*, Coulter Electronics Sales Company — Canada). Although the example given here employs the Coulter Counter® to determine the increase in growth, other methods of analysis (e.g. carbon or pigment) could be employed equally well providing they have sufficient sensitivity to measure small differences in biomass.

METHOD

A. CAPABILITIES

The capabilities of this technique are those of the method employed for the determination of an increase in biomass. In the particular example given here, the capabilities are the same as those given for the measurement of particle size spectra (see Section IV.12).

B. OUTLINE OF METHOD

The expression $\frac{V - \hat{D}}{V_0 - \hat{D}} = e^{\hat{k}(t - t_0)}$ is used to obtain an estimate of k , the true growth constant. V_0 is the total quantity of particulate material at the beginning of the incubation time, ($t = 0$), V is the total quantity of particulate material at time t , \hat{D} is an estimate of the true volume of detritus, (D), and \hat{k} is the corresponding value of k . Since the true growth constant (k) will not change with time, values of \hat{k} are plotted against time, and the value of \hat{D} at which \hat{k} vs t has zero slope is taken as a measure of the true volume of detritus (D). By substituting this value of D back into the above equation, the growth constant of the phytoplankton (k) can be obtained.

Note: Two assumptions are made in the application of the technique as described here. The first is that the growth rate (k) remains constant and the second is that the quantity of detritus (D) remains constant. In addition, any initial living plant material which does not grow subsequently will be counted as "detritus."

C. SPECIAL APPARATUS

Coulter Counter®, Model B. Several 1-liter clear glass-stoppered bottles in which to incubate sea water.

D. EXPERIMENTAL

PROCEDURE

1. Measure the size spectrum of suspended material in sea water as described in Section IV.12.IV.2.

2. Incubate a 1-liter sample in a glass-stoppered bottle either at the depth from which the sample was taken or in a light incubator such as is employed in ^{14}C photosynthetic studies.

3. Remeasure the size spectrum of particulate material after successive time periods (e.g. at 12 hr intervals).

4. Determine the total volume of material produced at different time intervals. Calculate \hat{k} (the apparent growth constant) by subtracting various values of \hat{D} (the estimated volume of detritus) from the total volume of material produced at different time intervals. The value of \hat{D} for which \hat{k} does not change with time is then used to correct the measured particle volumes to give the true phytoplankton volumes at different times.

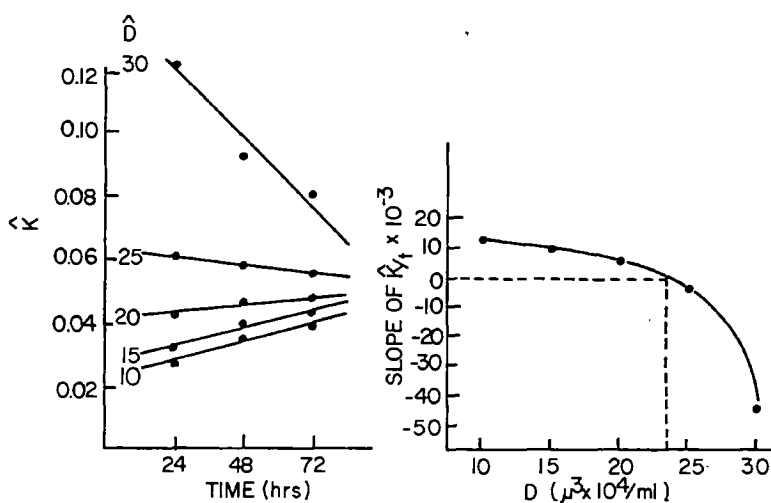

FIG. 8. Estimation of the quantity of detritus.

Example: A sample of sea water was collected during the winter from Departure Bay, British Columbia, and incubated at 10 C for several days. After an initial lag phase a small population of phytoplankton developed and the growth of this population was followed for the next 72 hr. The results are shown in the accompanying table.

Growth rate of a natural phytoplankton population.

Location: Departure Bay
 Date: 24/12/66
 Period of Incubation: 72 hours
 Continuous illumination

Diameter (μ)	Time Interval (hr)			
	0	24	48	72
	Coulter Counter Volumes ($\mu^3 \times 10^4/ml$)			
7.12	3.9	6.3	14.0	34
8.98	5.0	8.5	32.0	91
11.3	4.0	7.5	32.5	106
14.3	3.8	6.1	17.2	52
18.0	3.3	4.4	5.8	15
22.6	3.1	5.0	3.5	6.2
28.5	2.5	5.0	5.8	9.8
35.9	4.4	5.1	11.0	26
45.3	0.7	4.2	10.0	35
57.0			1.8	20
71.9				18
90.5				5.4
Total:	31	52	134	438

The calculation of the true growth constant of this population is also shown in Fig. 8 and as follows:

Calculation of \hat{k}

When \hat{D} ($\times 10^{-4}$) is	10	15	20	25	30
For: $V_0 = 31 \times 10^4$; $V = 52 \times 10^4$; $t = 24$;					
$V - \hat{D}$ ($\times 10^{-4}$) =	42	37	32	27	22
$V_0 - \hat{D}$ ($\times 10^{-4}$) =	21	16	11	6	1
$\frac{V - \hat{D}}{V_0 - \hat{D}}$ =	2	2.3	2.9	4.5	22
$\hat{k} = \log_e \frac{V - \hat{D}}{V_0 - \hat{D}} / t$ =	0.029	0.034	0.044	0.063	0.128

For: $V_0 = 31 \times 10^4$; $V = 134 \times 10^4$; $t = 48$;

\hat{k}	=	0.0367	0.042	0.049	0.060	0.097
<i>For: $V_0 = 31 \times 10^4$; $V = 438 \times 10^4$; $t = 72$;</i>						
\hat{k}	=	0.042	0.045	0.050	0.056	0.084

The values of \hat{k} at different times for different values of \hat{D} are plotted in Fig. 8. The slopes of the lines are determined for:

$$\hat{D} (\times 10^{-4}) = \quad 10 \quad 15 \quad 20 \quad 25 \quad 30$$

$$\text{The slopes of } \hat{k} \text{ on } t \text{ for the time interval, } t = 24 \text{ to } t = 72 \text{ are}$$

$$0.0129 \quad 0.0104 \quad 0.0058 \quad -0.0041 \quad -0.044$$

and it may be seen that the value of \hat{D} for which there is no change in \hat{k} with time is $23.5 \times 10^4 \mu^3/\text{ml}$. The volume of detritus is therefore $23.5 \times 10^4 \mu^3/\text{ml}$, and the original phytoplankton volume (V_0) is $7.5 \times 10^4 \mu^3/\text{ml}$ (i.e. $31.0 - 23.5 \mu^3/\text{ml}$).

$$\text{The growth constant, } k_e \text{ (hr)}^{-1} \text{ is } \frac{\log_e (134 - 23.5) - \log_e 7.5}{48} = 0.0565$$

$$\text{and the generation time is } \frac{0.69}{0.0565} = 12.2 \text{ hr}$$

The accompanying table shows that the population of phytoplankton developed two peaks, one at a diameter of 11.3μ and the other at a diameter of 45.3μ . The growth constant for the total population was estimated but it is possible to obtain separate growth constants for the two different phytoplankton populations shown in the table.

PART VI. TABLES AND SPECIAL DIAGRAMS

VI.1. TEMPERATURE CORRECTION FOR CHLOROSITY DETERMINATION

TABLE I.

Temperature correction for chlorosity determination.

V	Temperature difference $T_{Ag} - T_{Cl}$					Temperature difference $T_{Ag} - T_{Cl}$				
	5	4	3	2	1	-1	-2	-3	-4	-5
	<i>Subtract correction</i>					<i>Add correction</i>				
15	0.020	0.016	0.012	0.008	0.004	0.004	0.007	0.011	0.013	0.016
15.5	.020	.016	.012	.009	.004	.004	.008	.011	.014	.017
16	.021	.017	.013	.009	.004	.004	.008	.012	.014	.017
16.5	.021	.017	.013	.009	.004	.004	.008	.012	.015	.018
17	.022	.018	.013	.009	.004	.005	.009	.013	.016	.019
17.5	.023	.018	.013	.009	.004	.005	.009	.013	.016	.020
18	.024	.019	.015	.010	.005	.005	.009	.013	.016	.020
18.5	.025	.019	.015	.010	.005	.005	.010	.014	.017	.021
19	.026	.020	.015	.011	.005	.005	.010	.015	.018	.022
19.5	.027	.021	.016	.011	.005	.005	.010	.015	.019	.023
20	.028	.022	.017	.011	.006	.006	.011	.016	.020	.024
20.5	.029	.023	.017	.012	.006	.006	.011	.016	.021	.025
21	.030	.024	.018	.012	.006	.006	.012	.017	.022	.026
21.5	.031	.025	.018	.013	.007	.007	.012	.018	.022	.027
22	.032	.026	.019	.013	.007	.007	.013	.018	.023	.028

VI.2. CONVERSION OF CHLOROSITY TO SALINITY

TABLE II.

Conversion of 20 C chlorosity, $Cl/liter_{(20)}$, to salinity, $S‰$, from the expression

$$S‰ = 0.03 + [1.8050 \times Cl/liter_{(20)} \times 1/\rho_{(20)}]$$

where $\rho_{(20)}$ is the density of sea water at chlorosity $Cl/liter_{(20)}$.

$Cl/liter_{(20)}$	$S‰$	$Cl/liter_{(20)}$	$S‰$	$Cl/liter_{(20)}$	$S‰$	$Cl/liter_{(20)}$	$S‰$
2.00	3.64	2.50	4.54	3.00	5.43	3.50	6.33
.01	.66	.51	.55	.01	.45	.51	.34
.02	.68	.52	.57	.02	.47	.52	.36
.03	.69	.53	.59	.03	.48	.53	.38
.04	.71	.54	.61	.04	.50	.54	.40
.05	.73	.55	.63	.05	.52	.55	.42
.06	.75	.56	.64	.06	.54	.56	.43
.07	.77	.57	.66	.07	.56	.57	.45
.08	.78	.58	.68	.08	.57	.58	.47
.09	.80	.59	.70	.09	.59	.59	.49
2.10	3.82	2.60	4.71	3.10	5.61	3.60	6.50
.11	.84	.61	.73	.11	.63	.61	.52
.12	.86	.62	.75	.12	.65	.62	.54
.13	.87	.63	.77	.13	.66	.63	.56
.14	.89	.64	.79	.14	.68	.64	.58
.15	.91	.65	.80	.15	.70	.65	.59
.16	.93	.66	.82	.16	.72	.66	.61
.17	.95	.67	.84	.17	.74	.67	.63
.18	.96	.68	.86	.18	.75	.68	.65
.19	3.98	.69	.88	.19	.77	.69	.67
2.20	4.00	2.70	4.89	3.20	5.79	3.70	6.68
.21	.02	.71	.91	.21	.81	.71	.70
.22	.03	.72	.93	.22	.82	.72	.72
.23	.05	.73	.95	.23	.84	.73	.74
.24	.07	.74	.97	.24	.86	.74	.76
.25	.09	.75	4.98	.25	.88	.75	.77
.26	.11	.76	5.00	.26	.90	.76	.79
.27	.12	.77	.02	.27	.91	.77	.81
.28	.14	.78	.04	.28	.93	.78	.83
.29	.16	.79	.06	.29	.95	.79	.84
2.30	4.18	2.80	5.07	3.30	5.97	3.80	6.86
.31	.20	.81	.09	.31	5.99	.81	.88
.32	.21	.82	.11	.32	6.00	.82	.90
.33	.23	.83	.13	.33	.02	.83	.92
.34	.25	.84	.14	.34	.04	.84	.93
.35	.27	.85	.16	.35	.06	.85	.95
.36	.29	.86	.18	.36	.08	.86	.97
.37	.30	.87	.20	.37	.09	.87	6.98
.38	.32	.88	.22	.38	.11	.88	7.01
.39	.34	.89	.24	.39	.13	.89	.02
2.40	4.36	2.90	5.25	3.40	6.15	3.90	7.04
.41	.37	.91	.27	.41	.16	.91	.06
.42	.39	.92	.29	.42	.18	.92	.08
.43	.41	.93	.31	.43	.20	.93	.10
.44	.43	.94	.32	.44	.22	.94	.11
.45	.45	.95	.34	.45	.24	.95	.13
.46	.46	.96	.36	.46	.25	.96	.15
.47	.48	.97	.38	.47	.27	.97	.17
.48	.50	.98	.40	.48	.29	.98	.18
.49	.52	.99	.41	.49	.31	.99	.20

TABLE II. — (Continued)

CI/liter ₍₂₀₎	S‰	CI/liter ₍₂₀₎	S‰	CI/liter ₍₂₀₎	S‰	CI/liter ₍₂₀₎	S‰
4.00	7.22	4.50	8.11	5.00	9.01	5.50	9.90
.01	.24	.51	.13	.01	.02	.51	.91
.02	.26	.52	.15	.02	.04	.52	.93
.03	.27	.53	.17	.03	.06	.53	.95
.04	.29	.54	.18	.04	.08	.54	.97
.05	.31	.55	.20	.05	.10	.55	.99
.06	.33	.56	.22	.06	.11	.56	10.00
.07	.35	.57	.24	.07	.13	.57	.02
.08	.36	.58	.26	.08	.15	.58	.04
.09	.38	.59	.27	.09	.17	.59	.06
4.10	7.40	4.60	8.29	5.10	9.18	5.60	10.07
.11	.42	.61	.31	.11	.20	.61	.09
.12	.43	.62	.33	.12	.22	.62	.11
.13	.45	.63	.35	.13	.24	.63	.13
.14	.47	.64	.36	.14	.26	.64	.15
.15	.49	.65	.38	.15	.27	.65	.16
.16	.51	.66	.40	.16	.29	.66	.18
.17	.52	.67	.42	.17	.31	.67	.20
.18	.54	.68	.44	.18	.33	.68	.22
.19	.56	.69	.45	.19	.34	.69	.24
4.20	7.58	4.70	8.47	5.20	9.36	5.70	10.25
.21	.60	.71	.49	.21	.38	.71	.27
.22	.61	.72	.51	.22	.40	.72	.29
.23	.63	.73	.52	.23	.42	.73	.31
.24	.65	.74	.54	.24	.43	.74	.32
.25	.67	.75	.56	.25	.45	.75	.34
.26	.68	.76	.58	.26	.47	.76	.36
.27	.70	.77	.60	.27	.49	.77	.38
.28	.72	.78	.61	.28	.50	.78	.40
.29	.74	.79	.63	.29	.52	.79	.41
4.30	7.76	4.80	8.65	5.30	9.54	5.80	10.43
.31	.77	.81	.67	.31	.56	.81	.45
.32	.79	.82	.69	.32	.58	.82	.47
.33	.81	.83	.70	.33	.59	.83	.48
.34	.83	.84	.72	.34	.61	.84	.50
.35	.85	.85	.74	.35	.63	.85	.52
.36	.86	.86	.76	.36	.65	.86	.54
.37	.88	.87	.77	.37	.67	.87	.56
.38	.90	.88	.79	.38	.68	.88	.57
.39	.92	.89	.81	.39	.70	.89	.59
4.40	7.93	4.90	8.83	5.40	9.72	5.90	10.61
.41	.95	.91	.85	.41	.74	.91	.63
.42	.97	.92	.86	.42	.75	.92	.64
.43	7.99	.93	.88	.43	.77	.93	.66
.44	8.01	.94	.90	.44	.79	.94	.68
.45	.02	.95	.92	.45	.81	.95	.70
.46	.04	.96	.94	.46	.83	.96	.72
.47	.06	.97	.95	.47	.84	.97	.73
.48	.08	.98	.97	.48	.86	.98	.75
.49	.10	.99	.99	.49	.88	.99	.77

(Continued)

TABLE II. — (Continued)

Cl/liter ₍₂₀₎	S‰	Cl/liter ₍₂₀₎	S‰	Cl/liter ₍₂₀₎	S‰	Cl/liter ₍₂₀₎	S‰
6.00	10.79	6.50	11.68	7.00	12.56	7.50	13.45
.01	.81	.51	.69	.01	.58	.51	.47
.02	.82	.52	.71	.02	.60	.52	.49
.03	.84	.53	.73	.03	.62	.53	.50
.04	.86	.54	.75	.04	.63	.54	.52
.05	.88	.55	.76	.05	.65	.55	.54
.06	.89	.56	.78	.06	.67	.56	.56
.07	.91	.57	.80	.07	.69	.57	.57
.08	.93	.58	.82	.08	.71	.58	.59
.09	.95	.59	.84	.09	.72	.59	.61
6.10	10.97	6.60	11.85	7.10	12.74	7.60	13.63
.11	10.98	.61	.87	.11	.76	.61	.65
.12	11.00	.62	.89	.12	.78	.62	.66
.13	.02	.63	.91	.13	.79	.63	.68
.14	.04	.64	.92	.14	.81	.64	.70
.15	.05	.65	.94	.15	.83	.65	.72
.16	.07	.66	.96	.16	.85	.66	.73
.17	.09	.67	11.98	.17	.86	.67	.75
.18	.11	.68	12.00	.18	.88	.68	.77
.19	.12	.69	.01	.19	.90	.69	.79
6.20	11.14	6.70	12.03	7.20	12.92	7.70	13.80
.21	.16	.71	.05	.21	.94	.71	.82
.22	.18	.72	.07	.22	.95	.72	.84
.23	.20	.73	.08	.23	.97	.73	.86
.24	.21	.74	.10	.24	12.99	.74	.88
.25	.23	.75	.12	.25	13.01	.75	.89
.26	.25	.76	.14	.26	.02	.76	.91
.27	.27	.77	.16	.27	.04	.77	.93
.28	.28	.78	.17	.28	.06	.78	.95
.29	.30	.79	.19	.29	.08	.79	.96
6.30	11.32	6.80	12.21	7.30	13.10	7.80	13.98
.31	.34	.81	.23	.31	.11	.81	14.00
.32	.36	.82	.24	.32	.13	.82	.02
.33	.37	.83	.26	.33	.15	.83	.03
.34	.39	.84	.28	.34	.17	.84	.05
.35	.41	.85	.30	.35	.18	.85	.07
.36	.43	.86	.31	.36	.20	.86	.09
.37	.44	.87	.33	.37	.22	.87	.11
.38	.46	.88	.35	.38	.24	.88	.12
.39	.48	.89	.37	.39	.25	.89	.14
6.40	11.50	6.90	12.39	7.40	13.27	7.90	14.16
.41	.52	.91	.40	.41	.29	.91	.18
.42	.53	.92	.42	.42	.31	.92	.19
.43	.55	.93	.44	.43	.33	.93	.21
.44	.57	.94	.46	.44	.34	.94	.23
.45	.59	.95	.47	.45	.36	.95	.25
.46	.60	.96	.49	.46	.38	.96	.27
.47	.62	.97	.51	.47	.40	.97	.28
.48	.64	.98	.53	.48	.41	.98	.30
.49	.66	.99	.55	.49	.43	.99	.32

TABLE II. — (Continued)

<i>Cl</i> /liter ₍₂₀₎	<i>S</i> %	<i>Cl</i> /liter ₍₂₀₎	<i>S</i> %	<i>Cl</i> /liter ₍₂₀₎	<i>S</i> %	<i>Cl</i> /liter ₍₂₀₎	<i>S</i> %
8.00	14.34	8.50	15.22	9.00	16.10	9.50	16.98
.01	.35	.51	.24	.01	.12	.51	17.00
.02	.37	.52	.25	.02	.14	.52	.02
.03	.39	.53	.27	.03	.16	.53	.03
.04	.41	.54	.29	.04	.17	.54	.05
.05	.42	.55	.31	.05	.19	.55	.07
.06	.44	.56	.33	.06	.21	.56	.09
.07	.46	.57	.34	.07	.23	.57	.11
.08	.48	.58	.36	.08	.24	.58	.12
.09	.50	.59	.38	.09	.26	.59	.14
8.10	14.51	8.60	15.40	9.10	16.28	9.60	17.16
.11	.53	.61	.41	.11	.30	.61	.18
.12	.55	.62	.43	.12	.31	.62	.19
.13	.57	.63	.45	.13	.33	.63	.21
.14	.58	.64	.47	.14	.35	.64	.23
.15	.60	.65	.48	.15	.37	.65	.25
.16	.62	.66	.50	.16	.38	.66	.26
.17	.64	.67	.52	.17	.40	.67	.28
.18	.65	.68	.54	.18	.42	.68	.30
.19	.67	.69	.56	.19	.44	.69	.32
8.20	14.69	8.70	15.57	9.20	16.45	9.70	17.33
.21	.71	.71	.59	.21	.47	.71	.35
.22	.72	.72	.61	.22	.49	.72	.37
.23	.74	.73	.63	.23	.51	.73	.39
.24	.76	.74	.64	.24	.53	.74	.40
.25	.78	.75	.66	.25	.54	.75	.42
.26	.80	.76	.68	.26	.56	.76	.44
.27	.81	.77	.70	.27	.58	.77	.46
.28	.83	.78	.71	.28	.60	.78	.47
.29	.85	.79	.73	.29	.61	.79	.49
8.30	14.87	8.80	15.75	9.30	16.63	9.80	17.51
.31	.88	.81	.77	.31	.65	.81	.53
.32	.90	.82	.79	.32	.67	.82	.54
.33	.92	.83	.80	.33	.68	.83	.56
.34	.94	.84	.82	.34	.70	.84	.58
.35	.95	.85	.84	.35	.72	.85	.60
.36	.97	.86	.86	.36	.74	.86	.62
.37	14.99	.87	.87	.37	.75	.87	.63
.38	15.01	.88	.89	.38	.77	.88	.65
.39	.03	.89	.91	.39	.79	.89	.67
8.40	15.04	8.90	15.93	9.40	16.81	9.90	17.69
.41	.06	.91	.94	.41	.82	.91	.70
.42	.08	.92	.96	.42	.84	.92	.72
.43	.10	.93	15.98	.43	.86	.93	.74
.44	.11	.94	16.00	.44	.88	.94	.76
.45	.13	.95	.01	.45	.89	.95	.77
.46	.15	.96	.03	.46	.91	.96	.79
.47	.17	.97	.05	.47	.93	.97	.81
.48	.18	.98	.07	.48	.95	.98	.83
.49	.20	.99	.09	.49	.96	.99	.85

(Continued)

TABLE II. — (Continued)

Cl/liter ₍₂₀₎	S‰	Cl/liter ₍₂₀₎	S‰	Cl/liter ₍₂₀₎	S‰	Cl/liter ₍₂₀₎	S‰
10.00	17.87	10.50	18.74	11.00	19.62	11.50	20.50
.01	.88	.51	.76	.01	.64	.51	.52
.02	.90	.52	.78	.02	.66	.52	.54
.03	.92	.53	.80	.03	.68	.53	.55
.04	.94	.54	.81	.04	.69	.54	.57
.05	.95	.55	.83	.05	.71	.55	.59
.06	.97	.56	.85	.06	.73	.56	.61
.07	17.99	.57	.87	.07	.75	.57	.62
.08	18.01	.58	.88	.08	.76	.58	.64
.09	.02	.59	.90	.09	.78	.59	.66
10.10	18.04	10.60	18.92	11.10	19.80	11.60	20.68
.11	.06	.61	.94	.11	.82	.61	.69
.12	.08	.62	.96	.12	.83	.62	.71
.13	.09	.63	.97	.13	.85	.63	.73
.14	.11	.64	18.99	.14	.87	.64	.75
.15	.13	.65	19.01	.15	.89	.65	.76
.16	.15	.66	.03	.16	.90	.66	.78
.17	.16	.67	.04	.17	.92	.67	.80
.18	.18	.68	.06	.18	.94	.68	.82
.19	.20	.69	.08	.19	.96	.69	.83
10.20	18.22	10.70	19.10	11.20	19.97	11.70	20.85
.21	.23	.71	.11	.21	19.99	.71	.87
.22	.25	.72	.13	.22	20.01	.72	.89
.23	.27	.73	.15	.23	.03	.73	.90
.24	.29	.74	.17	.24	.04	.74	.92
.25	.30	.75	.18	.25	.06	.75	.94
.26	.32	.76	.20	.26	.08	.76	.96
.27	.34	.77	.22	.27	.10	.77	.97
.28	.36	.78	.24	.28	.11	.78	20.99
.29	.38	.79	.25	.29	.13	.79	21.01
10.30	18.39	10.80	19.27	11.30	20.15	11.80	21.03
.31	.41	.81	.29	.31	.17	.81	.04
.32	.43	.82	.31	.32	.18	.82	.06
.33	.45	.83	.32	.33	.20	.83	.08
.34	.46	.84	.34	.34	.22	.84	.10
.35	.48	.85	.36	.35	.24	.85	.11
.36	.50	.86	.38	.36	.26	.86	.13
.37	.52	.87	.39	.37	.27	.87	.15
.38	.53	.88	.41	.38	.29	.88	.17
.39	.55	.89	.43	.39	.31	.89	.18
10.40	18.57	10.90	19.45	11.40	20.33	11.90	21.20
.41	.59	.91	.47	.41	.34	.91	.22
.42	.60	.92	.48	.42	.36	.92	.24
.43	.62	.93	.50	.43	.38	.93	.26
.44	.64	.94	.52	.44	.40	.94	.27
.45	.66	.95	.54	.45	.41	.95	.29
.46	.67	.96	.55	.46	.43	.96	.31
.47	.69	.97	.57	.47	.45	.97	.33
.48	.71	.98	.59	.48	.47	.98	.34
.49	.73	.99	.61	.49	.48	.99	.36

TABLE II. — (Continued)

<i>Cl</i> /liter ₍₂₀₎	<i>S</i> %	<i>Cl</i> /liter ₍₂₀₎	<i>S</i> %	<i>Cl</i> /liter ₍₂₀₎	<i>S</i> %	<i>Cl</i> /liter ₍₂₀₎	<i>S</i> %
12.00	21.38	12.50	22.25	13.00	23.13	13.50	24.00
.01	.40	.51	.27	.01	.14	.51	.02
.02	.41	.52	.29	.02	.16	.52	.03
.03	.43	.53	.30	.03	.18	.53	.05
.04	.45	.54	.32	.04	.20	.54	.07
.05	.47	.55	.34	.05	.21	.55	.09
.06	.48	.56	.36	.06	.23	.56	.10
.07	.50	.57	.37	.07	.25	.57	.12
.08	.52	.58	.39	.08	.27	.58	.14
.09	.54	.59	.41	.09	.28	.59	.16
12.10	21.55	12.60	22.43	13.10	23.30	13.60	24.17
.11	.57	.61	.44	.11	.32	.61	.19
.12	.59	.62	.46	.12	.34	.62	.21
.13	.61	.63	.48	.13	.35	.63	.23
.14	.62	.64	.50	.14	.37	.64	.24
.15	.64	.65	.51	.15	.39	.65	.26
.16	.66	.66	.53	.16	.41	.66	.28
.17	.68	.67	.55	.17	.42	.67	.30
.18	.69	.68	.57	.18	.44	.68	.31
.19	.71	.69	.58	.19	.46	.69	.33
12.20	21.73	12.70	22.60	13.20	23.48	13.70	24.35
.21	.75	.71	.62	.21	.49	.71	.37
.22	.76	.72	.64	.22	.51	.72	.38
.23	.78	.73	.65	.23	.53	.73	.40
.24	.80	.74	.67	.24	.55	.74	.42
.25	.82	.75	.69	.25	.56	.75	.44
.26	.83	.76	.71	.26	.58	.76	.45
.27	.85	.77	.72	.27	.60	.77	.47
.28	.87	.78	.74	.28	.62	.78	.49
.29	.89	.79	.76	.29	.63	.79	.51
12.30	21.90	12.80	22.78	13.30	23.65	13.80	24.52
.31	.92	.81	.79	.31	.67	.81	.54
.32	.94	.82	.81	.32	.69	.82	.56
.33	.96	.83	.83	.33	.70	.83	.58
.34	.97	.84	.85	.34	.72	.84	.59
.35	21.99	.85	.86	.35	.74	.85	.61
.36	22.01	.86	.88	.36	.76	.86	.63
.37	.03	.87	.90	.37	.77	.87	.65
.38	.04	.88	.92	.38	.79	.88	.66
.39	.06	.89	.93	.39	.81	.89	.68
12.40	22.08	12.90	22.95	13.40	23.83	13.90	24.70
.41	.09	.91	.97	.41	.84	.91	.72
.42	.11	.92	22.99	.42	.86	.92	.73
.43	.13	.93	23.00	.43	.88	.93	.75
.44	.15	.94	.02	.44	.89	.94	.77
.45	.16	.95	.04	.45	.91	.95	.79
.46	.18	.96	.06	.46	.93	.96	.80
.47	.20	.97	.07	.47	.95	.97	.82
.48	.22	.98	.09	.48	.96	.98	.84
.49	.23	.99	.11	.49	.98	.99	.85

(Continued)

TABLE II. — (Continued)

<i>Cl</i> /liter ₍₂₀₎	<i>S</i> %	<i>Cl</i> /liter ₍₂₀₎	<i>S</i> %	<i>Cl</i> /liter ₍₂₀₎	<i>S</i> %	<i>Cl</i> /liter ₍₂₀₎	<i>S</i> %
14.00	24.87	14.50	25.74	15.00	26.61	15.50	27.48
.01	.89	.51	.76	.01	.63	.51	.50
.02	.91	.52	.78	.02	.65	.52	.51
.03	.92	.53	.79	.03	.66	.53	.53
.04	.94	.54	.81	.04	.68	.54	.55
.05	.96	.55	.83	.05	.70	.55	.57
.06	.98	.56	.85	.06	.72	.56	.58
.07	24.99	.57	.86	.07	.73	.57	.60
.08	25.01	.58	.88	.08	.75	.58	.62
.09	.03	.59	.90	.09	.77	.59	.64
14.10	25.05	14.60	25.92	15.10	26.79	15.60	27.65
.11	.06	.61	.93	.11	.80	.61	.67
.12	.08	.62	.95	.12	.82	.62	.69
.13	.10	.63	.97	.13	.84	.63	.71
.14	.12	.64	25.99	.14	.86	.64	.72
.15	.13	.65	26.00	.15	.87	.65	.74
.16	.15	.66	.02	.16	.89	.66	.76
.17	.17	.67	.04	.17	.91	.67	.77
.18	.19	.68	.06	.18	.92	.68	.79
.19	.20	.69	.07	.19	.94	.69	.81
14.20	25.22	14.70	26.09	15.20	26.96	15.70	27.83
.21	.24	.71	.11	.21	.98	.71	.84
.22	.26	.72	.13	.22	26.99	.72	.86
.23	.27	.73	.14	.23	27.01	.73	.88
.24	.29	.74	.16	.24	.03	.74	.90
.25	.31	.75	.18	.25	.05	.75	.91
.26	.32	.76	.19	.26	.06	.76	.93
.27	.34	.77	.21	.27	.08	.77	.95
.28	.36	.78	.23	.28	.10	.78	.97
.29	.38	.79	.25	.29	.12	.79	.98
14.30	25.39	14.80	26.26	15.30	27.13	15.80	28.00
.31	.41	.81	.28	.31	.15	.81	.02
.32	.43	.82	.30	.32	.17	.82	.03
.33	.45	.83	.32	.33	.18	.83	.05
.34	.46	.84	.33	.34	.20	.84	.07
.35	.48	.85	.35	.35	.22	.85	.09
.36	.50	.86	.37	.36	.24	.86	.10
.37	.52	.87	.39	.37	.25	.87	.12
.38	.53	.88	.40	.38	.27	.88	.14
.39	.55	.89	.42	.39	.29	.89	.16
14.40	25.57	14.90	26.44	15.40	27.31	15.90	28.17
.41	.59	.91	.46	.41	.32	.91	.19
.42	.60	.92	.47	.42	.34	.92	.21
.43	.62	.93	.49	.43	.36	.93	.23
.44	.64	.94	.51	.44	.38	.94	.24
.45	.66	.95	.53	.45	.39	.95	.26
.46	.67	.96	.54	.46	.41	.96	.28
.47	.69	.97	.56	.47	.43	.97	.29
.48	.71	.98	.58	.48	.44	.98	.31
.49	.72	.99	.59	.49	.46	.99	.33

TABLE II. — (Continued)

<i>Cl</i> /liter ₍₂₀₎	<i>S</i> %	<i>Cl</i> /liter ₍₂₀₎	<i>S</i> %	<i>Cl</i> /liter ₍₂₀₎	<i>S</i> %	<i>Cl</i> /liter ₍₂₀₎	<i>S</i> %
16.00	28.35	16.50	29.21	17.00	30.08	17.50	30.94
.01	.36	.51	.23	.01	.09	.51	.96
.02	.38	.52	.25	.02	.11	.52	.98
.03	.40	.53	.26	.03	.13	.53	30.99
.04	.42	.54	.28	.04	.15	.54	31.01
.05	.43	.55	.30	.05	.16	.55	.03
.06	.45	.56	.32	.06	.18	.56	.04
.07	.47	.57	.33	.07	.20	.57	.06
.08	.49	.58	.35	.08	.22	.58	.08
.09	.50	.59	.37	.09	.23	.59	.10
16.10	28.52	16.60	29.39	17.10	30.25	17.60	31.11
.11	.54	.61	.40	.11	.27	.61	.13
.12	.55	.62	.42	.12	.28	.62	.15
.13	.57	.63	.44	.13	.30	.63	.17
.14	.59	.64	.45	.14	.32	.64	.18
.15	.61	.65	.47	.15	.34	.65	.20
.16	.62	.66	.49	.16	.35	.66	.22
.17	.64	.67	.51	.17	.37	.67	.23
.18	.66	.68	.52	.18	.39	.68	.25
.19	.68	.69	.54	.19	.41	.69	.27
16.20	28.69	16.70	29.56	17.20	30.42	17.70	31.29
.21	.71	.71	.58	.21	.44	.71	.30
.22	.73	.72	.59	.22	.46	.72	.32
.23	.75	.73	.61	.23	.47	.73	.34
.24	.76	.74	.63	.24	.49	.74	.36
.25	.78	.75	.65	.25	.51	.75	.37
.26	.80	.76	.66	.26	.53	.76	.39
.27	.82	.77	.68	.27	.54	.77	.41
.28	.83	.78	.70	.28	.56	.78	.42
.29	.85	.79	.71	.29	.58	.79	.44
16.30	28.87	16.80	29.73	17.30	30.60	17.80	31.46
.31	.88	.81	.75	.31	.61	.81	.48
.32	.90	.82	.77	.32	.63	.82	.49
.33	.92	.83	.78	.33	.65	.83	.51
.34	.94	.84	.80	.34	.66	.84	.53
.35	.95	.85	.82	.35	.68	.85	.55
.36	.97	.86	.84	.36	.70	.86	.56
.37	28.99	.87	.85	.37	.72	.87	.58
.38	29.00	.88	.87	.38	.73	.88	.60
.39	.02	.89	.89	.39	.75	.89	.61
16.40	29.04	16.90	29.90	17.40	30.77	17.90	31.63
.41	.06	.91	.92	.41	.79	.91	.65
.42	.07	.92	.94	.42	.80	.92	.67
.43	.09	.93	.96	.43	.82	.93	.68
.44	.11	.94	.97	.44	.84	.94	.70
.45	.13	.95	29.99	.45	.85	.95	.72
.46	.14	.96	30.01	.46	.87	.96	.74
.47	.16	.97	.03	.47	.89	.97	.75
.48	.18	.98	.04	.48	.91	.98	.77
.49	.20	.99	.06	.49	.92	.99	.79

(Continued)

TABLE II. — (Continued)

Cl/liter ₍₂₀₎	S‰	Cl/liter ₍₂₀₎	S‰	Cl/liter ₍₂₀₎	S‰	Cl/liter ₍₂₀₎	S‰
18.00	31.80	18.50	32.67	19.00	33.53	19.50	34.39
.01	.82	.51	.68	.01	.54	.51	.40
.02	.84	.52	.70	.02	.56	.52	.42
.03	.86	.53	.72	.03	.58	.53	.44
.04	.87	.54	.73	.04	.60	.54	.46
.05	.89	.55	.75	.05	.61	.55	.47
.06	.91	.56	.77	.06	.63	.56	.49
.07	.92	.57	.79	.07	.65	.57	.51
.08	.94	.58	.80	.08	.67	.58	.52
.09	.96	.59	.82	.09	.68	.59	.54
18.10	31.98	18.60	32.84	19.10	33.70	19.60	34.56
.11	31.99	.61	.86	.11	.72	.61	.58
.12	32.01	.62	.87	.12	.73	.62	.59
.13	.03	.63	.89	.13	.75	.63	.61
.14	.05	.64	.91	.14	.77	.64	.63
.15	.06	.65	.92	.15	.79	.65	.64
.16	.08	.66	.94	.16	.80	.66	.66
.17	.10	.67	.96	.17	.82	.67	.68
.18	.11	.68	.98	.18	.84	.68	.70
.19	.13	.69	32.99	.19	.85	.69	.71
18.20	32.15	18.70	33.01	19.20	33.87	19.70	34.73
.21	.17	.71	.03	.21	.89	.71	.75
.22	.18	.72	.05	.22	.91	.72	.77
.23	.20	.73	.06	.23	.92	.73	.78
.24	.22	.74	.08	.24	.94	.74	.80
.25	.23	.75	.10	.25	.96	.75	.82
.26	.25	.76	.11	.26	.97	.76	.83
.27	.27	.77	.13	.27	33.99	.77	.85
.28	.29	.78	.15	.28	34.01	.78	.87
.29	.30	.79	.17	.29	.03	.79	.89
18.30	32.32	18.80	33.18	19.30	34.04	19.80	34.90
.31	.34	.81	.20	.31	.06	.81	.92
.32	.36	.82	.22	.32	.08	.82	.94
.33	.37	.83	.23	.33	.09	.83	.95
.34	.39	.84	.25	.34	.11	.84	.97
.35	.41	.85	.27	.35	.13	.85	34.99
.36	.42	.86	.29	.36	.15	.86	35.01
.37	.44	.87	.30	.37	.16	.87	.02
.38	.46	.88	.32	.38	.18	.88	.04
.39	.48	.89	.34	.39	.20	.89	.06
18.40	32.49	18.90	33.36	19.40	34.22	19.90	35.07
.41	.51	.91	.37	.41	.23	.91	.09
.42	.53	.92	.39	.42	.25	.92	.11
.43	.55	.93	.41	.43	.27	.93	.13
.44	.56	.94	.42	.44	.28	.94	.14
.45	.58	.95	.44	.45	.30	.95	.16
.46	.60	.96	.46	.46	.32	.96	.18
.47	.61	.97	.48	.47	.34	.97	.19
.48	.63	.98	.49	.48	.35	.98	.21
.49	.65	.99	.51	.49	.37	.99	.23

TABLE II. — (Continued)

Cl/liter ₍₂₀₎	S%	Cl/liter ₍₂₀₎	S%	Cl/liter ₍₂₀₎	S%	Cl/liter ₍₂₀₎	S%
20.00	35.25	20.50	36.11	21.00	36.96	21.50	37.82
.01	.27	.51	.12	.01	36.98	.51	.83
.02	.28	.52	.14	.02	37.00	.52	.85
.03	.30	.53	.16	.03	.01	.53	.87
.04	.32	.54	.18	.04	.03	.54	.89
.05	.34	.55	.19	.05	.05	.55	.90
.06	.35	.56	.21	.06	.06	.56	.92
.07	.37	.57	.23	.07	.08	.57	.94
.08	.39	.58	.24	.08	.10	.58	.95
.09	.40	.59	.26	.09	.12	.59	.97
20.10	35.42	20.60	36.28	21.10	37.13	21.60	37.99
.11	.44	.61	.30	.11	.15	.61	38.00
.12	.46	.62	.31	.12	.17	.62	.02
.13	.47	.63	.33	.13	.18	.63	.04
.14	.50	.64	.35	.14	.20	.64	.06
.15	.51	.65	.36	.15	.22	.65	.07
.16	.52	.66	.38	.16	.24	.66	.09
.17	.54	.67	.40	.17	.25	.67	.11
.18	.56	.68	.41	.18	.27	.68	.12
.19	.58	.69	.43	.19	.29	.69	.14
20.20	35.59	20.70	36.45	21.20	37.30	21.70	38.16
.21	.61	.71	.47	.21	.32	.71	.17
.22	.63	.72	.48	.22	.34	.72	.19
.23	.64	.73	.50	.23	.36	.73	.21
.24	.66	.74	.52	.24	.37	.74	.23
.25	.68	.75	.53	.25	.39	.75	.24
.26	.70	.76	.55	.26	.40	.76	.26
.27	.71	.77	.57	.27	.42	.77	.28
.28	.73	.78	.59	.28	.44	.78	.29
.29	.74	.79	.60	.29	.46	.79	.31
20.30	35.76	20.80	36.62	21.30	37.47	21.80	38.33
.31	.78	.81	.64	.31	.49	.81	.34
.32	.80	.82	.65	.32	.51	.82	.36
.33	.82	.83	.67	.33	.53	.83	.38
.34	.83	.84	.69	.34	.54	.84	.40
.35	.85	.85	.71	.35	.56	.85	.41
.36	.87	.86	.72	.36	.58	.86	.43
.37	.88	.87	.74	.37	.59	.87	.45
.38	.90	.88	.76	.38	.61	.88	.46
.39	.92	.89	.77	.39	.63	.89	.48
20.40	35.93	20.90	36.79	21.40	37.65	21.90	38.50
.41	.95	.91	.81	.41	.66	.91	.51
.42	.97	.92	.83	.42	.68	.92	.53
.43	35.99	.93	.84	.43	.70	.93	.55
.44	36.00	.94	.86	.44	.71	.94	.57
.45	.02	.95	.88	.45	.73	.95	.58
.46	.04	.96	.89	.46	.75	.96	.60
.47	.06	.97	.91	.47	.77	.97	.62
.48	.07	.98	.93	.48	.78	.98	.63
.49	.09	.99	.94	.49	.80	.99	.65
						22.00	38.67

VI.3. TEMPERATURE CORRECTIONS FOR pH MEASUREMENTS

TABLE III. Temperature corrections for pH measurements. If pH_s is the original value of the pH of the sample *in situ* at a temperature t C and pH_m is the pH measured in the laboratory at t_m C (generally greater than t C), then

$$pH_s = pH_m - \alpha(t - t_m).$$

α is given in the Table.

pH_m	$S = 18\%$ $Cl = 10\%$			$S = 27\%$ $Cl = 15\%$		
	t C 0-10	t C 10-20	t C 20-30	t C 0-10	t C 10-20	t C 20-30
	α	α	α	α	α	α
7.4	0.0087	0.0084	0.0069	0.0088	0.0087	0.0076
7.6	0.0092	0.0092	0.0079	0.0095	0.0096	0.0083
7.8	0.0100	0.0101	0.0089	0.0103	0.0105	0.0090
8.0	0.0108	0.0109	0.0094	0.0110	0.0112	0.0094
8.2	0.0114	0.0115	0.0098	0.0115	0.0117	0.0096
8.4	0.0117	0.0117	0.0099	0.0118	0.0118	0.0098
	$S = 35\%$ $Cl = 19.5\%$			$S = 38\%$ $Cl = 21\%$		
7.4	0.0089	0.0087	0.0081	0.0092	0.0089	0.0079
7.6	0.0095	0.0095	0.0091	0.0097	0.0098	0.0088
7.8	0.0104	0.0104	0.0098	0.0106	0.0108	0.0093
8.0	0.0110	0.0109	0.0102	0.0112	0.0114	0.0096
8.2	0.0114	0.0112	0.0103	0.0116	0.0116	0.0098
8.4	0.0116	0.0114	0.0104	0.0118	0.0119	0.0100

VI.4. PRESSURE CORRECTIONS FOR pH MEASUREMENTS

TABLE IV. Pressure corrections for pH measurements. If pH_d is the original value of the pH of the sample *in situ* at a depth d meters and pH_s is the pH measured under atmospheric pressure, then

$$pH_d = pH_s - \beta d$$

β is given in the Table.

pH_s	$\beta \times 10^6$	pH_s	$\beta \times 10^6$
7.5	35	8.0	22
7.6	31	8.1	21
7.7	28	8.2	20
7.8	25	8.3	20
7.9	23	8.4	20

VI.5. CONVERSION OF pH TO HYDROGEN ION ACTIVITY

TABLE V. Conversion of pH to hydrogen ion activity from the relation $a_H = 10^{-pH}$. For a pH of $Q + v$ (where v is the decimal part) find N from the Table in terms of v and substitute in the equation:

$$a_H = N \times 10^{-Q}$$

v	N	v	N	v	N
0.00	1.000	0.34	0.457	0.67	0.214
0.01	0.977	0.35	0.447	0.68	0.209
0.02	0.955	0.36	0.437	0.69	0.204
0.03	0.933	0.37	0.427	0.70	0.200
0.04	0.912	0.38	0.417	0.71	0.195
.0.05	0.891	0.39	0.407	0.72	0.191
0.06	0.871	0.40	0.398	0.73	0.186
0.07	0.851	0.41	0.389	0.74	0.182
0.08	0.832	0.42	0.380	0.75	0.178
0.09	0.813	0.43	0.372	0.76	0.174
0.10	0.794	0.44	0.363	0.77	0.170
0.11	0.776	0.45	0.355	0.78	0.166
0.12	0.759	0.46	0.347	0.79	0.162
0.13	0.741	0.47	0.339	0.80	0.158
0.14	0.725	0.48	0.331	0.81	0.155
0.15	0.709	0.49	0.324	0.82	0.151
0.16	0.692	0.50	0.316	0.83	0.148
0.17	0.676	0.51	0.309	0.84	0.144
0.18	0.661	0.52	0.302	0.85	0.141
0.19	0.646	0.53	0.295	0.86	0.138
0.20	0.631	0.54	0.288	0.87	0.135
0.21	0.617	0.55	0.282	0.88	0.132
0.22	0.603	0.56	0.275	0.89	0.129
0.23	0.589	0.57	0.269	0.90	0.126
0.24	0.575	0.58	0.263	0.91	0.123
0.25	0.562	0.59	0.257	0.92	0.120
0.26	0.549	0.60	0.251	0.93	0.117
0.27	0.537	0.61	0.245	0.94	0.115
0.28	0.525	0.62	0.240	0.95	0.112
0.29	0.513	0.63	0.234	0.96	0.110
0.30	0.501	0.64	0.229	0.97	0.107
0.31	0.490	0.65	0.224	0.98	0.105
0.32	0.479	0.66	0.219	0.99	0.102
0.33	0.468				

VI.6. FACTORS FOR TOTAL ALKALINITY MEASUREMENT

TABLE VI. Factors for total alkalinity measurement. Factor f in the equation:

$$\text{Total alkalinity} = 2.500 - 1250 a_{\text{H}}/f$$

is found as a function of chlorinity or salinity.

pH range	Cl‰ = 2 S‰ = 3.5	4	6	8	10	12-18 21-33	20
	f	f	f	f	f	f	f
2.8-2.9	0.865	0.800	0.785	0.775	0.770	0.768	0.773
3.0-3.9	0.845	0.782	0.770	0.760	0.755	0.753	0.758
4.0	0.890	0.822	0.810	0.800	0.795	0.793	0.798

VI.7. TOTAL ALKALINITY CALCULATION

TABLE VII. Total alkalinity calculation. Total alkalinity (1 liter 20 C) as a function of the final pH of the solution obtained from 100.0 ml of sample and 25.00 ml of 0.01000 N hydrochloric acid. This Table may be used for samples of chlorinity between 12‰ and 18‰, or salinities between 22‰ and 33‰.

pH	Total alkalinity	pH	Total alkalinity	pH	Total alkalinity
3.00	0.84	3.30	1.67	3.60	2.08
3.02	0.92	3.32	1.71	3.62	2.10
3.04	0.99	3.34	1.74	3.64	2.12
3.06	1.06	3.36	1.77	3.66	2.14
3.08	1.12	3.38	1.81	3.68	2.15
3.10	1.19	3.40	1.84	3.70	2.17
3.12	1.24	3.42	1.87	3.72	2.18
3.14	1.30	3.44	1.90	3.74	2.20
3.16	1.35	3.46	1.93	3.76	2.21
3.18	1.40	3.48	1.95	3.78	2.23
3.20	1.45	3.50	1.98	3.80	2.24
3.22	1.50	3.52	2.00	3.82	2.25
3.24	1.55	3.54	2.02	3.84	2.26
3.26	1.59	3.56	2.04	3.86	2.27
3.28	1.63	3.58	2.06	3.88	2.28
				3.90	2.29

VI.8. CONVERSION OF TOTAL ALKALINITY TO CARBONATE ALKALINITY

TABLE VIII. Conversion of total alkalinity to carbonate alkalinity. Quantity, A , milliequivalents per liter, to be subtracted from the total alkalinity to give the carbonate alkalinity in milliequivalents per liter.

Note. Multiply the value in the table by 10^{-2} to get A .

$pH_{8(d)}$	$^{\circ}C = 0$	2	4	6	8	10	12	14	16	18	20	22	24	26	28	30
	$Cl = 15\%$								$S = 27\%$							
7.3	0	0	0	0	0	0	0	0	0	0	0	0	0	0	0	1
7.4	1	1	1	1	1	1	1	1	1	1	1	1	1	1	1	2
7.5	1	1	1	1	1	1	1	1	2	2	2	2	2	2	2	2
7.6	1	1	1	1	2	2	2	2	2	2	2	2	2	2	2	2
7.7	2	2	2	2	2	2	2	2	2	2	2	2	3	3	3	3
7.8	2	2	2	2	2	2	2	3	3	3	3	3	3	3	3	3
7.9	3	3	3	3	3	3	3	3	3	3	3	3	3	3	3	3
8.0	3	3	3	4	4	4	4	4	4	4	4	4	4	4	4	4
8.1	4	4	4	4	4	5	5	5	5	5	5	5	5	5	5	5
8.2	5	5	5	5	5	6	6	6	6	6	6	6	6	6	6	6
8.3	6	6	6	6	7	7	7	7	7	7	7	7	7	7	7	7
8.4	7	7	7	8	8	8	8	8	8	8	8	8	8	8	8	8
8.5	8	9	9	9	10	10	10	10	10	10	10	10	10	10	10	11
8.6	10	10	11	11	11	12	12	12	12	12	12	12	12	12	12	13
8.7	12	12	12	13	13	13	14	14	14	14	14	15	15	15	15	16
8.8	15	15	15	15	16	16	17	17	17	17	18	18	18	19	19	19
	$Cl = 17\%$								$S = 31\%$							
7.3	0	0	0	0	0	0	0	0	0	1	1	1	1	1	1	1
7.4	1	1	1	1	1	1	1	1	1	2	2	2	2	2	2	2
7.5	1	1	1	1	2	2	2	2	2	2	2	2	2	2	2	2
7.6	2	2	2	2	2	2	2	2	2	2	2	2	2	2	2	2
7.7	2	2	2	2	2	2	2	3	3	3	3	3	3	3	3	3
7.8	3	3	3	3	3	3	3	3	3	3	3	3	3	3	3	3
7.9	3	3	3	3	3	3	3	3	3	4	4	4	4	4	4	4
8.0	4	4	4	4	4	4	4	4	4	4	4	4	4	4	4	4
8.1	5	5	5	5	5	5	5	5	5	5	5	5	5	5	5	5
8.2	6	6	6	6	6	6	6	6	6	6	6	6	6	6	6	6
8.3	7	7	7	8	8	8	8	8	8	8	8	8	8	8	8	8
8.4	8	9	9	9	10	10	10	10	10	10	10	10	10	10	10	10
8.5	10	10	11	11	11	12	12	12	12	12	12	12	12	12	12	13
8.6	12	12	13	13	13	14	14	14	14	14	14	14	14	14	14	15
8.7	14	14	15	15	15	16	16	16	16	16	16	16	16	16	16	17
8.8	17	17	18	18	19	19	19	20	20	20	21	21	21	21	22	23
	$Cl = 19\%$								$S = 34\%$							
7.3	0	0	0	0	1	1	1	1	1	1	1	1	1	1	1	1
7.4	1	1	1	1	1	2	2	2	2	2	2	2	2	2	2	2
7.5	2	2	2	2	2	2	2	2	2	2	2	2	2	2	2	2
7.6	2	2	2	2	2	2	2	3	3	3	3	3	3	3	3	3
7.7	2	3	3	3	3	3	3	3	3	3	3	3	3	3	3	3
7.8	3	3	3	3	3	4	4	4	4	4	4	4	4	4	4	4
7.9	4	4	4	4	4	4	4	4	4	4	4	4	4	4	4	4
8.0	5	5	5	5	5	5	5	5	5	5	5	5	5	5	5	5
8.1	6	6	6	6	6	6	6	6	6	6	6	6	6	6	6	6
8.2	7	7	7	7	7	7	7	7	7	7	7	7	7	7	7	7
8.3	8	9	9	9	9	9	9	9	9	9	9	9	9	9	9	9
8.4	10	10	11	11	11	11	12	12	12	12	12	12	12	12	12	12
8.5	12	12	13	13	13	14	14	14	14	14	14	14	14	14	14	14
8.6	14	14	15	15	15	16	16	16	16	16	16	16	16	16	16	16
8.7	16	16	17	17	17	18	18	18	18	18	18	18	18	18	18	18
8.8	19	20	20	21	21	21	22	22	22	23	23	24	24	24	25	25

(Continued)

TABLE VI.8. (continued)

$pH_{s(d)}$	$^{\circ}C=0$	2	4	6	8	10	12	14	16	18	20	22	24	26	28	30
	$Cl = 21\%$								$S = 38\%$							
7.3	0	1	1	1	1	1	1	1	1	1	1	1	1	1	2	2
7.4	1	2	2	2	2	2	2	2	2	2	2	2	2	2	3	3
7.5	2	2	2	2	2	2	2	2	3	3	3	3	3	3	3	3
7.6	2	2	2	3	3	3	3	3	3	3	3	4	4	4	4	4
7.7	3	3	3	3	3	4	4	4	4	4	4	4	4	5	5	5
7.8	4	4	4	4	4	5	5	5	5	5	5	5	6	6	6	6
7.9	4	4	5	5	5	5	6	6	6	6	7	7	7	7	7	7
8.0	5	6	6	6	6	7	7	7	7	8	8	8	8	8	9	9
8.1	7	7	7	7	8	8	8	8	9	9	9	10	10	10	10	11
8.2	8	8	9	9	9	10	10	10	10	11	11	11	12	12	12	13
8.3	10	10	10	11	11	11	12	12	12	13	13	14	14	14	15	15
8.4	11	11	11	12	12	13	13	13	14	14	14	15	15	15	16	16
8.5	14	14	14	15	15	16	16	17	17	18	18	19	19	19	20	20
8.6	16	16	17	17	18	18	19	19	20	20	21	21	22	22	22	23
8.7	18	19	19	20	20	21	21	22	22	23	23	24	24	24	25	25
8.8	22	22	23	23	24	24	25	25	26	26	27	27	28	28	28	29

VI.9. CONVERSION OF CARBONATE ALKALINITY TO TOTAL CARBON DIOXIDE

TABLE IX. Conversion of carbonate alkalinity to total carbon dioxide. In the body of the Table may be found factor, F_T , from the equation:

$$\text{Total carbon dioxide content} = \text{carbonate alkalinity} \times F_T.$$

$pH_{8(d)}$	$^{\circ}C = 0$															
	0	2	4	6	8	10	12	14	16	18	20	22	24	26	28	30
	$Cl = 15\%$							$S = 27\%$								
7.3	1.07	1.06	1.06	1.06	1.05	1.05	1.05	1.05	1.04	1.04	1.04	1.04	1.03	1.03	1.03	1.03
7.4	1.05	1.05	1.04	1.04	1.04	1.04	1.03	1.03	1.03	1.03	1.03	1.02	1.02	1.02	1.02	1.02
7.5	1.04	1.03	1.03	1.03	1.03	1.02	1.02	1.02	1.02	1.02	1.01	1.01	1.01	1.01	1.01	1.01
7.6	1.02	1.02	1.02	1.02	1.02	1.01	1.01	1.01	1.01	1.01	1.00	1.00	1.00	1.00	.99	.99
7.7	1.01	1.01	1.01	1.01	1.00	1.00	1.00	1.00	1.00	.99	.99	.99	.99	.99	.98	.98
7.8	1.00	1.00	1.00	1.00	.99	.99	.99	.99	.99	.98	.98	.98	.98	.97	.97	.97
7.9	.99	.99	.99	.99	.98	.98	.98	.98	.98	.97	.97	.97	.97	.96	.96	.96
8.0	.98	.98	.98	.98	.97	.97	.97	.97	.96	.96	.96	.96	.96	.95	.95	.94
8.1	.97	.97	.97	.97	.96	.96	.96	.96	.95	.95	.95	.94	.94	.93	.93	.93
8.2	.96	.96	.96	.95	.95	.94	.94	.94	.93	.93	.93	.92	.92	.91	.91	.91
8.3	.95	.95	.94	.94	.94	.93	.93	.93	.92	.92	.91	.91	.90	.90	.89	.89
8.4	.93	.93	.93	.92	.92	.92	.91	.91	.90	.90	.89	.89	.88	.88	.87	.86
8.5	.92	.91	.91	.91	.90	.90	.89	.89	.88	.88	.87	.86	.86	.85	.85	.84
8.6	.90	.89	.89	.89	.88	.88	.87	.87	.86	.85	.85	.84	.83	.83	.82	.81
	$Cl = 17\%$							$S = 31\%$								
7.3	1.06	1.06	1.06	1.05	1.05	1.05	1.04	1.04	1.04	1.04	1.03	1.03	1.03	1.03	1.03	1.03
7.4	1.05	1.04	1.04	1.04	1.04	1.03	1.03	1.03	1.03	1.02	1.02	1.02	1.02	1.02	1.02	1.01
7.5	1.03	1.03	1.03	1.02	1.02	1.02	1.02	1.02	1.01	1.01	1.01	1.01	1.01	1.01	1.00	1.00
7.6	1.02	1.02	1.02	1.01	1.01	1.01	1.01	1.01	1.00	1.00	1.00	1.00	1.00	.99	.99	.99
7.7	1.01	1.01	1.01	1.00	1.00	1.00	1.00	1.00	.99	.99	.99	.99	.98	.98	.98	.98
7.8	1.00	1.00	1.00	.99	.99	.99	.99	.98	.98	.98	.98	.97	.97	.97	.97	.96
7.9	.99	.99	.99	.98	.98	.98	.98	.97	.97	.97	.97	.96	.96	.96	.95	.95
8.0	.98	.98	.97	.97	.97	.97	.96	.96	.96	.95	.95	.94	.94	.93	.94	.94
8.1	.97	.97	.96	.96	.96	.95	.95	.95	.94	.94	.94	.93	.93	.92	.92	.92
8.2	.96	.95	.95	.95	.94	.94	.94	.93	.93	.93	.92	.92	.92	.91	.91	.90
8.3	.94	.94	.94	.93	.93	.92	.92	.92	.91	.91	.90	.90	.90	.89	.88	.88
8.4	.93	.92	.92	.92	.91	.91	.90	.90	.89	.89	.88	.88	.87	.87	.86	.86
8.5	.91	.91	.90	.90	.89	.89	.88	.88	.87	.87	.86	.86	.85	.84	.84	.83
8.6	.89	.89	.88	.87	.87	.86	.86	.85	.85	.84	.84	.83	.82	.82	.81	.80
	$Cl = 19\%$							$S = 34\%$								
7.3	1.06	1.06	1.05	1.05	1.05	1.04	1.04	1.04	1.04	1.03	1.03	1.03	1.02	1.02	1.03	1.02
7.4	1.04	1.04	1.04	1.03	1.03	1.03	1.03	1.03	1.02	1.02	1.02	1.02	1.01	1.01	1.01	1.01
7.5	1.03	1.03	1.02	1.02	1.02	1.02	1.02	1.01	1.01	1.01	1.01	1.01	1.00	1.00	1.00	1.00
7.6	1.02	1.02	1.01	1.01	1.01	1.01	1.00	1.00	1.00	1.00	1.00	.99	.99	.99	.99	.98
7.7	1.01	1.00	1.00	1.00	1.00	1.00	1.00	.99	.99	.99	.99	.98	.98	.98	.98	.97
7.8	1.00	.99	.99	.99	.99	.99	.98	.98	.98	.97	.97	.96	.96	.96	.95	.94
7.9	.99	.98	.98	.98	.97	.97	.96	.96	.96	.95	.95	.94	.94	.94	.93	.93
8.0	.98	.97	.97	.97	.96	.96	.96	.96	.95	.95	.95	.94	.94	.94	.93	.93
8.1	.96	.96	.96	.96	.95	.95	.95	.94	.94	.94	.93	.93	.93	.92	.92	.91
8.2	.95	.95	.95	.94	.94	.94	.93	.93	.92	.92	.92	.91	.91	.90	.90	.89
8.3	.94	.93	.93	.93	.92	.92	.91	.91	.91	.90	.90	.89	.89	.88	.88	.87
8.4	.92	.92	.91	.91	.90	.90	.90	.89	.89	.88	.88	.87	.86	.86	.85	.84
8.5	.90	.90	.89	.89	.88	.88	.87	.87	.86	.86	.85	.85	.84	.83	.83	.82
8.6	.88	.88	.87	.87	.86	.86	.85	.84	.84	.83	.83	.82	.81	.81	.80	.79
	$Cl = 21\%$							$S = 38\%$								
7.3	1.06	1.05	1.05	1.04	1.04	1.04	1.04	1.04	1.03	1.03	1.03	1.03	1.02	1.02	1.02	1.02
7.4	1.04	1.04	1.03	1.03	1.03	1.03	1.02	1.02	1.02	1.02	1.01	1.01	1.01	1.01	1.01	1.00
7.5	1.03	1.02	1.02	1.02	1.02	1.02	1.01	1.01	1.01	1.01	1.00	1.00	1.00	1.00	1.00	.99
7.6	1.01	1.01	1.01	1.01	1.01	1.00	1.00	1.00	1.00	.99	.99	.99	.99	.99	.98	.98
7.7	1.00	1.00	1.00	1.00	.99	.99	.99	.99	.99	.98	.98	.98	.98	.97	.97	.97
7.8	.99	.99	.99	.99	.98	.98	.98	.98	.97	.97	.97	.97	.96	.96	.96	.95
7.9	.98	.98	.97	.97	.97	.97	.96	.96	.96	.95	.95	.94	.94	.94	.93	.93
8.0	.97	.97	.96	.96	.96	.96	.95	.95	.94	.94	.93	.93	.93	.92	.92	.91
8.1	.96	.95	.95	.94	.94	.93	.93	.93	.92	.92	.91	.91	.90	.90	.89	.88
8.2	.95	.94	.94	.94	.93	.93	.93	.92	.92	.91	.91	.90	.90	.89	.88	.87
8.3	.93	.93	.92	.92	.92	.91	.91	.90	.90	.89	.89	.88	.87	.87	.86	.86
8.4	.91	.91	.91	.90	.90	.89	.89	.88	.88	.87	.87	.86	.85	.85	.84	.83
8.5	.89	.89	.89	.88	.88	.88	.87	.86	.86	.85	.84	.84	.83	.82	.81	.80
8.6	.87	.87	.86	.86	.85	.85	.84	.83	.83	.82	.82	.81	.80	.79	.78	.77

VI.10. CONVERSION OF CARBONATE ALKALINITY TO PARTIAL PRESSURE OF CARBON DIOXIDE

TABLE X. Conversion of carbonate alkalinity to partial pressure of carbon dioxide. In the body of the table may be found factor, F_p , from the equation:

$$\text{Partial pressure of carbon dioxide } (P_{\text{CO}_2}) = \text{carbonate alkalinity} \times F_p.$$

Note: Multiply the value in the Table by 10^{-3} to get F_p .

$pH_{s(d)}$	$^{\circ}C = 0$	2	4	6	8	10	12	14	16	18	20	22	24	26	28	30
	$Cl = 15\text{‰}$								$S = 27\text{‰}$							
7.3	1.12	1.14	1.17	1.19	1.22	1.26	1.29	1.32	1.36	1.39	1.42	1.45	1.49	1.54	1.59	1.64
7.4	.89	.90	.92	.94	.97	1.00	1.02	1.05	1.07	1.10	1.12	1.15	1.17	1.21	1.25	1.29
7.5	.70	.71	.73	.74	.77	.79	.81	.83	.85	.87	.88	.90	.93	.96	.99	1.01
7.6	.56	.56	.58	.59	.60	.62	.64	.65	.67	.68	.70	.71	.73	.75	.78	.80
7.7	.44	.44	.45	.46	.48	.49	.50	.51	.53	.54	.55	.56	.57	.59	.61	.62
7.8	.35	.35	.36	.36	.37	.39	.39	.40	.41	.42	.43	.44	.45	.46	.47	.49
7.9	.27	.27	.28	.29	.29	.30	.31	.31	.32	.33	.33	.34	.35	.36	.37	.38
8.0	.21	.21	.22	.22	.23	.24	.24	.25	.25	.26	.26	.27	.28	.29	.29	.29
8.1	.17	.17	.17	.17	.18	.18	.19	.19	.20	.20	.20	.20	.21	.21	.22	.22
8.2	.13	.13	.13	.14	.14	.14	.15	.15	.15	.15	.16	.16	.16	.17	.17	.17
8.3	.10	.10	.10	.10	.11	.11	.11	.11	.12	.12	.12	.12	.12	.12	.13	.13
8.4	.08	.08	.08	.08	.08	.08	.08	.09	.09	.09	.09	.09	.09	.09	.10	.10
8.5	.06	.06	.06	.06	.06	.06	.06	.07	.07	.07	.07	.07	.07	.07	.07	.07
8.6	.05	.05	.05	.05	.05	.05	.05	.05	.05	.05	.05	.05	.05	.05	.05	.05
	$Cl = 17\text{‰}$								$S = 31\text{‰}$							
7.3	1.09	1.10	1.13	1.16	1.19	1.23	1.26	1.29	1.31	1.34	1.37	1.41	1.44	1.49	1.54	1.57
7.4	.86	.87	.89	.91	.94	.97	1.00	1.02	1.04	1.06	1.08	1.11	1.14	1.18	1.22	1.24
7.5	.68	.69	.71	.72	.74	.77	.79	.80	.82	.84	.85	.87	.90	.93	.96	.97
7.6	.54	.54	.56	.57	.59	.60	.62	.63	.64	.66	.67	.69	.70	.73	.75	.76
7.7	.42	.43	.44	.45	.46	.48	.49	.50	.51	.52	.53	.54	.55	.57	.59	.60
7.8	.33	.34	.35	.35	.36	.37	.38	.39	.40	.40	.41	.42	.43	.44	.46	.46
7.9	.26	.26	.27	.28	.28	.29	.30	.31	.31	.32	.32	.33	.34	.35	.36	.36
8.0	.21	.21	.21	.22	.22	.23	.23	.24	.24	.25	.25	.25	.26	.27	.27	.28
8.1	.16	.16	.17	.17	.17	.18	.18	.18	.19	.19	.19	.20	.20	.21	.21	.21
8.2	.12	.13	.13	.13	.13	.14	.14	.14	.15	.15	.15	.15	.16	.16	.16	.16
8.3	.10	.10	.10	.10	.10	.10	.11	.11	.11	.11	.11	.11	.12	.12	.12	.12
8.4	.07	.07	.08	.08	.08	.08	.08	.08	.08	.08	.09	.09	.09	.09	.09	.09
8.5	.06	.06	.06	.06	.06	.06	.06	.06	.06	.06	.06	.06	.07	.07	.07	.07
8.6	.04	.04	.04	.04	.04	.05	.05	.05	.05	.05	.05	.05	.05	.05	.05	.05
	$Cl = 19\text{‰}$								$S = 34\text{‰}$							
7.3	1.05	1.07	1.10	1.12	1.14	1.18	1.21	1.24	1.28	1.30	1.33	1.36	1.40	1.43	1.48	1.52
7.4	.83	.84	.87	.89	.90	.93	.96	.98	1.01	1.02	1.05	1.07	1.10	1.13	1.17	1.20
7.5	.66	.67	.69	.70	.71	.74	.76	.77	.80	.81	.82	.84	.87	.89	.92	.94
7.6	.52	.53	.54	.55	.56	.58	.60	.61	.63	.63	.65	.66	.68	.70	.72	.74
7.7	.41	.41	.43	.44	.44	.46	.47	.48	.49	.50	.51	.52	.53	.54	.56	.58
7.8	.32	.33	.33	.34	.35	.36	.37	.37	.39	.39	.40	.41	.42	.42	.44	.45
7.9	.25	.26	.26	.27	.27	.28	.29	.29	.30	.30	.31	.32	.32	.33	.34	.35
8.0	.20	.20	.20	.21	.21	.22	.22	.23	.23	.23	.24	.24	.25	.25	.26	.27
8.1	.15	.16	.16	.16	.16	.17	.17	.18	.18	.18	.18	.19	.19	.19	.20	.20
8.2	.12	.12	.12	.13	.13	.13	.13	.14	.14	.14	.14	.14	.15	.15	.15	.15
8.3	.09	.09	.10	.10	.10	.10	.10	.10	.11	.11	.11	.11	.11	.11	.11	.12
8.4	.07	.07	.07	.07	.07	.08	.08	.08	.08	.08	.08	.08	.08	.08	.09	.09
8.5	.05	.05	.06	.06	.06	.06	.06	.06	.06	.06	.06	.06	.06	.06	.06	.06
8.6	.04	.04	.04	.04	.04	.04	.04	.04	.04	.04	.04	.04	.04	.05	.05	.05
	$Cl = 21\text{‰}$								$S = 38\text{‰}$							
7.3	1.02	1.04	1.07	1.08	1.11	1.15	1.18	1.20	1.24	1.26	1.29	1.32	1.36	1.39	1.44	1.47
7.4	.81	.82	.84	.85	.88	.91	.94	.95	.98	.99	1.01	1.04	1.07	1.09	1.13	1.15
7.5	.64	.65	.67	.67	.69	.72	.74	.75	.77	.78	.80	.82	.84	.86	.89	.90
7.6	.50	.51	.53	.53	.55	.57	.58	.59	.60	.61	.63	.64	.66	.67	.70	.71
7.7	.40	.40	.41	.42	.43	.44	.46	.46	.47	.48	.49	.50	.51	.53	.54	.55
7.8	.31	.32	.32	.33	.34	.35	.36	.36	.37	.37	.38	.39	.40	.41	.42	.43
7.9	.24	.25	.25	.26	.26	.27	.28	.28	.29	.29	.30	.30	.31	.32	.33	.33
8.0	.19	.19	.20	.20	.20	.21	.22	.22	.22	.23	.23	.23	.24	.24	.25	.25
8.1	.15	.15	.15	.15	.16	.16	.17	.17	.17	.17	.18	.18	.18	.19	.19	.19
8.2	.11	.12	.12	.12	.12	.13	.13	.13	.13	.13	.14	.14	.14	.14	.14	.14
8.3	.09	.09	.09	.09	.09	.10	.10	.10	.10	.10	.10	.10	.10	.10	.11	.11
8.4	.07	.07	.07	.07	.07	.07	.07	.07	.08	.08	.08	.08	.08	.08	.08	.08
8.5	.05	.05	.05	.05	.05	.05	.06	.06	.06	.06	.06	.06	.06	.06	.06	.06
8.6	.04	.04	.04	.04	.04	.04	.04	.04	.04	.04	.04	.04	.04	.04	.04	.04

VI.11 SOLUBILITY OF CARBON DIOXIDE IN SEA WATER

TABLE XI. Solubility, (γ) millimoles per liter, of carbon dioxide in sea water.

<i>S</i> %	<i>C</i> %	Degrees Centigrade							
		0	2	4	6	8	10	12	14
		Solubility							
27	15	67.4	62.3	57.8	53.8	50.4	47.2	44.2	41.6
28	16	66.7	61.7	57.3	53.3	49.9	46.8	43.8	41.3
30.5	17	66.0	61.1	56.7	52.8	49.5	46.4	43.4	41.0
32.5	18	65.3	60.5	56.2	52.4	49.0	46.0	43.1	40.6
34	19	64.6	59.9	55.7	51.9	48.6	45.6	42.8	40.3
36	20	64.0	59.3	55.1	51.4	48.2	45.2	42.4	40.0
38	21	63.3	58.7	54.6	50.9	47.7	44.8	42.1	39.6
		16	18	20	22	24	26	28	30
		Solubility							
27	15	39.3	37.1	35.1	33.1	31.4	29.9	28.4	27.0
28	16	39.0	36.8	34.8	32.9	31.2	29.7	28.1	26.8
30.5	17	38.7	36.5	34.6	32.7	31.0	29.4	27.9	26.6
32.5	18	38.4	36.2	34.3	32.4	30.7	29.2	27.7	26.4
34	19	38.1	35.9	34.0	32.1	30.4	28.9	27.5	26.2
36	20	37.7	35.6	33.7	31.9	30.2	28.7	27.3	26.0
38	21	37.4	35.4	33.5	31.7	30.0	28.5	27.1	25.8

VI.12. QUASI-THERMODYNAMIC SECOND DISSOCIATION CONSTANT OF CARBONIC ACID IN SEA WATER

TABLE XII. Values for K , the quasi-thermodynamic second dissociation constant of carbonic acid in sea water.

Note: Multiply the figures in the Table by 10^{-9} to get K .

S‰	Cl‰	Degrees Centigrade							
		0	2	4	6	8	10	12	14
		K value $\times 10^9$							
27	15	0.33	0.35	0.36	0.38	0.40	0.42	0.45	0.47
28	16	0.35	0.37	0.38	0.41	0.43	0.45	0.47	0.50
30.5	17	0.36	0.38	0.40	0.43	0.45	0.48	0.50	0.53
32.5	18	0.38	0.40	0.42	0.45	0.47	0.50	0.53	0.55
34	19	0.40	0.42	0.44	0.47	0.50	0.52	0.55	0.58
36	20	0.42	0.44	0.46	0.49	0.53	0.55	0.58	0.61
38	21	0.44	0.47	0.48	0.52	0.54	0.56	0.60	0.63
		16	18	20	22	24	26	28	30
		K value $\times 10^9$							
27	15	0.50	0.53	0.56	0.60	0.63	0.67	0.72	0.76
28	16	0.53	0.56	0.59	0.63	0.66	0.71	0.75	0.79
30.5	17	0.55	0.59	0.62	0.65	0.69	0.73	0.78	0.83
32.5	18	0.58	0.62	0.65	0.69	0.73	0.77	0.83	0.88
34	19	0.61	0.65	0.68	0.72	0.76	0.81	0.86	0.93
36	20	0.65	0.68	0.71	0.76	0.80	0.85	0.91	0.98
38	21	0.67	0.71	0.74	0.79	0.84	0.90	0.97	1.05

VI.13. TOTAL CARBON DIOXIDE BY GAS ANALYSIS

TABLE XIII. Total carbon dioxide by gas analysis.

Cl%	S‰	16 C	17 C	18 C	19 C	20 C	21 C	22 C
13	23.5	78.01	77.48	76.98	76.48	75.99	75.49	74.98
15	27.0	77.88	77.35	76.85	76.34	75.87	75.38	74.90
17	30.5	77.75	77.23	76.71	76.23	75.76	75.30	74.82
19	34.5	77.62	77.10	76.58	76.12	75.62	75.17	74.68
		23 C	24 C	25 C	26 C	27 C	28 C	
13	23.5	74.55	74.09	73.69	73.26	72.86	72.44	
15	27.0	74.46	74.01	73.60	73.18	72.78	72.35	
17	30.5	74.38	73.92	73.50	73.07	72.67	72.26	
19	34.5	74.27	73.80	73.40	72.97	72.56	72.17	

The table gives values of F as a function of temperature and salinity in the expression:

$$\text{mg carbon dioxide C/m}^3 = (P_1 - P_2) \cdot F$$

where $P_1 - P_2$ is the difference in mm of Hg in the Van Slyke gas analysis apparatus using 5.00 ml of sample, 1.2 ml of reagents (acid and alkali), and compressing the gas to 0.5000 ml. t is the jacket temperature in deg C.

$$F = 1.200 \cdot 10^7 \cdot \frac{0.5000}{5.000} \cdot \frac{1.037}{760 \times 22.265} \cdot \frac{1}{(1 + 0.00384t)} \cdot \left[1 + \frac{6.2}{43.8} \cdot a \cdot 22.27 \right]$$

The coefficient 0.00384 allows for the expansion of both gas and mercury. a is the solubility of CO_2 in sea water of a given temperature and salinity expressed in moles/liter at NP.

Other expressions that may be useful are

$$\text{mgCO}_2/\text{liter} = \text{mg carbon dioxide C/m}^3 \times 0.003666$$

$$\text{millimoles CO}_2/\text{liter} = \text{mg carbon dioxide C/m}^3 \times 0.0000833$$

VI.14. OXYGEN SOLUBILITY NOMOGRAPH

TABLE XIV. Nomograph for oxygen solubility in sea water at equilibrium with water-saturated air at one atmosphere total pressure and oxygen 0.2094 mole fraction excluding water vapour. (Reproduced by permission from J. Marine Res., 25 (2): 146, 1967.)

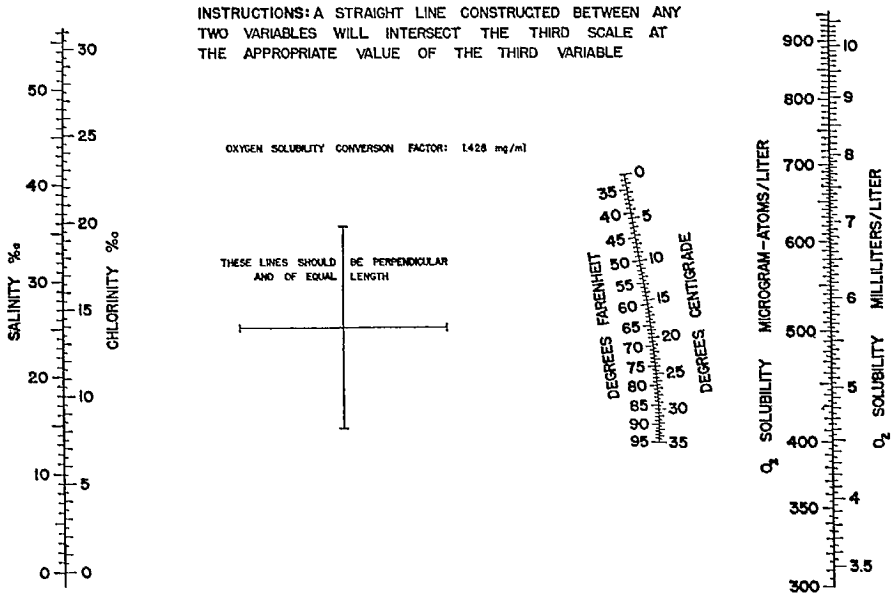
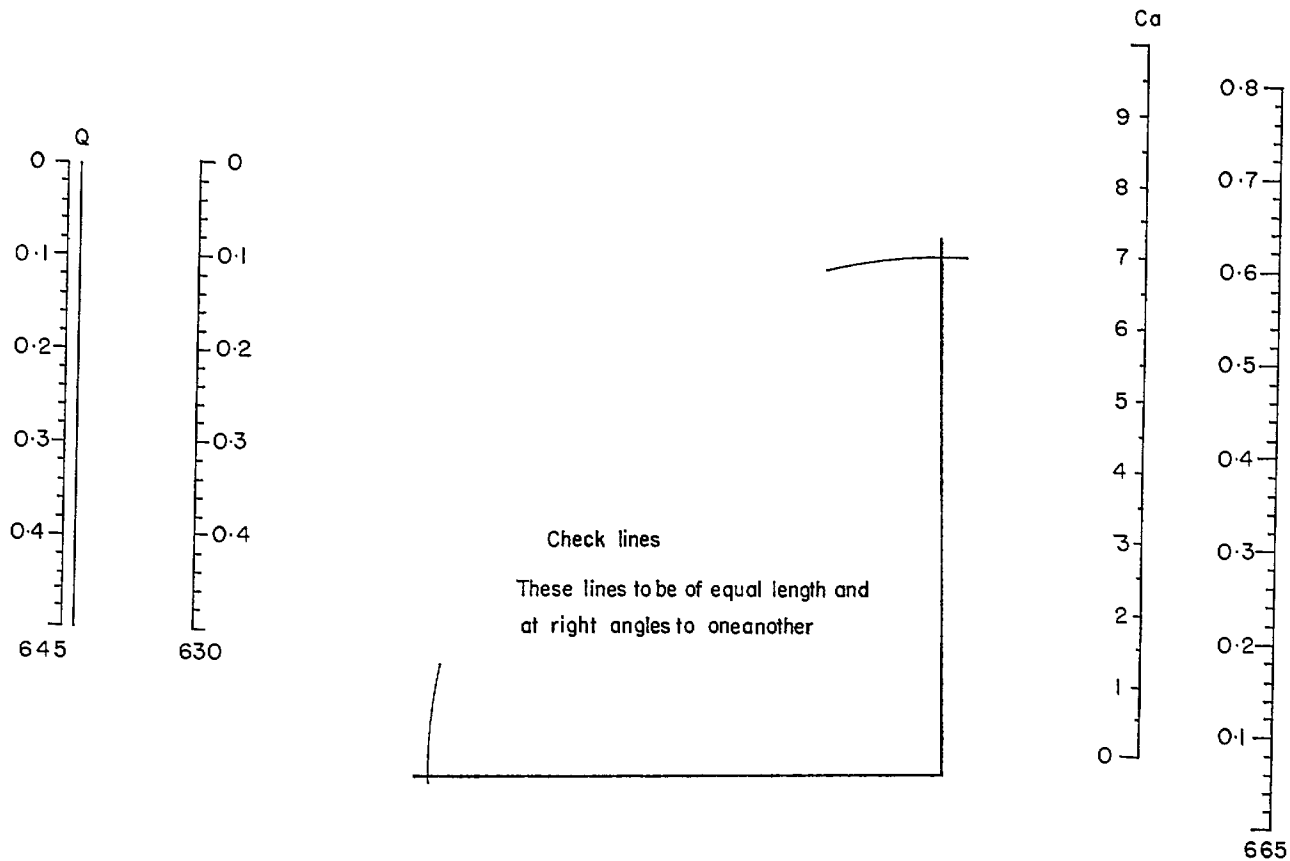

TABLE XV. (a) Chlorophyll *a* nomograph. (Reproduced by permission from *J. Fish. Res. Bd. Canada*, 22(6): 1576, 1965.)

$$Ca = 11.6 \frac{665}{630} - 0.14 \frac{665}{645} - 1.31$$

306



VI.15. PHYTOPLANKTON PIGMENT NOMOGRAPHS

TABLE XV. (b) Chlorophyll *b* nomograph. (Reproduced by permission from *J. Fish Res. Bd. Canada*, 22(6): 1577, 1965.)

$$Cb = 20.7 \frac{645}{665} - 4.34 \frac{665}{630} - 4.42$$

307

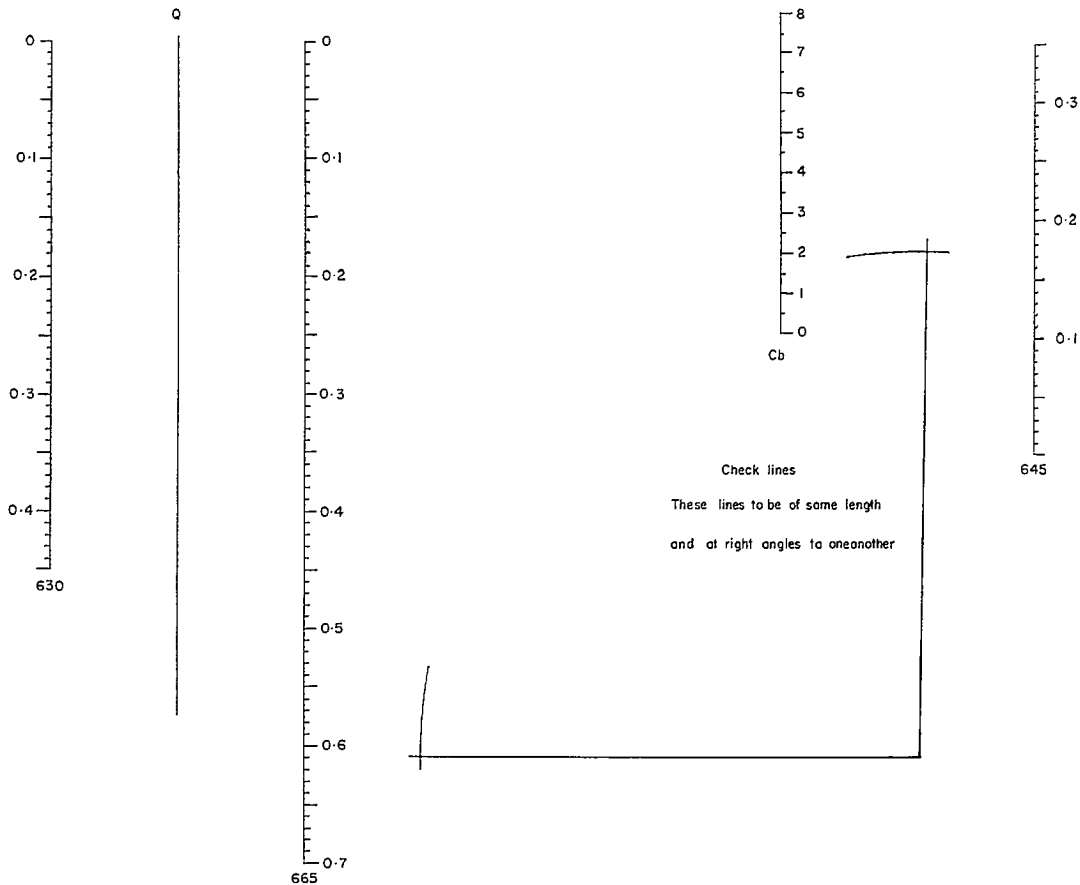
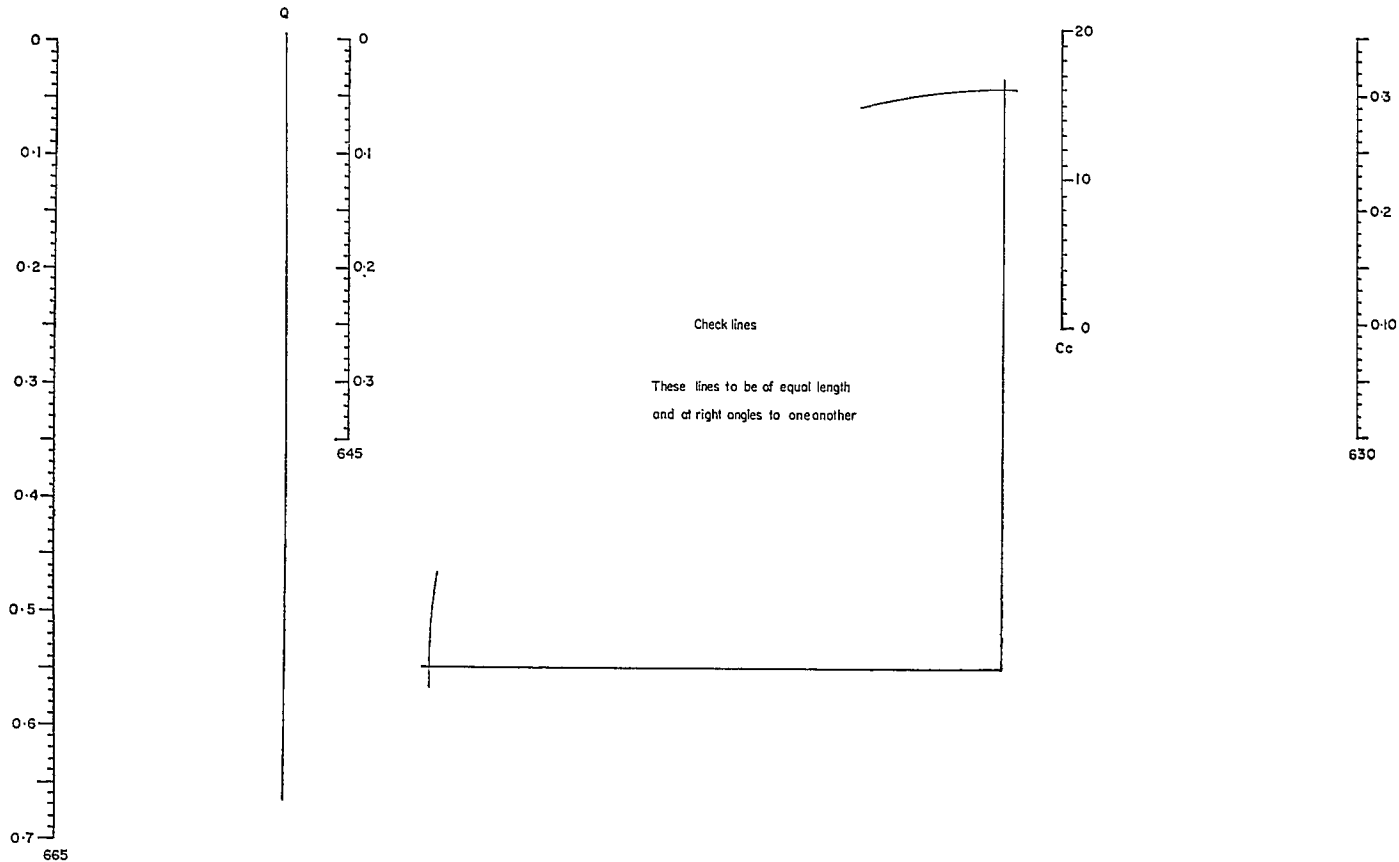

TABLE XV. (c) Chlorophyll *c* nomograph. (Reproduced by permission from *J. Fish. Res. Bd. Canada*, 22(6): 1578, 1965.)

$$C_c = 55_{630} - 16.3_{645} - 4.64_{665}$$

308



**VI.16. A GRADE SCALE BASED ON
1- μ PARTICLE DIAMETER**

TABLE XVI. A grade scale based on 1- μ particle diameter in which particle volume varies by a factor of 2 in successive grades (from Sheldon and Parsons, *A Practical Manual on the Use of the Coulter Counter® in Marine Research*, Coulter Electronic Sales Company — Canada, 1967).

Diameter (μ)	Volume (μ^3)	Volume (μ^3)	Diameter (μ)
1.00	0.52		
1.26	1.04	0.73	1.12
1.58	2.08	1.47	1.41
2.00	4.19	2.94	1.78
2.52	8.38	5.92	2.24
3.18	16.8	11.8	2.82
4.00	33.5	23.8	3.57
5.04	67.0	47.4	4.49
6.34	134	94.7	5.66
8.00	268	189	7.12
10.1	536	379	8.98
12.7		758	11.3
16.0	1.07×10^3	1.52×10^3	14.3
20.2	2.15×10^3	3.03×10^3	18.0
25.4	4.29×10^3	6.07×10^3	22.6
32.0	8.58×10^3	12.1×10^3	28.5
40.3	17.2×10^3	24.3×10^3	35.9
50.8	34.3×10^3	48.6×10^3	45.3
64.0	68.7×10^3	97.1×10^3	57.0
80.6	137×10^3	194×10^3	71.9
102	275×10^3	388×10^3	90.5
128	549×10^3	777×10^3	114
161	1.10×10^6	1.56×10^6	144
203	2.20×10^6	3.11×10^6	181
256	4.40×10^6	6.22×10^6	228
322	8.79×10^6	12.4×10^6	287
404	17.6×10^6	24.9×10^6	361
512	35.1×10^6	49.6×10^6	452
646	70.3×10^6	99.4×10^6	573
812	141×10^6	199×10^6	724
1020	281×10^6		
	562×10^6	397×10^6	909

VI.17. COINCIDENCE CORRECTION CHART FOR DIFFERENT SIZED APERTURES

TABLE XVII. Coincidence correction chart for different sized apertures (taken from *Instruction and Service Manual for the Model B Coulter Counter®*).

