

**Population ecology and genetics of the
polychaete *Scoloplos armiger* (Orbiniidae)**

**Populationsökologie und –genetik des
Polychaeten *Scoloplos armiger* (Orbiniidae)**

Inken Kruse

<http://www.awi-bremerhaven.de/Publications/Kru2002d.pdf>

Ber. Polarforsch. Meeresforsch. xxx (2003)

ISSN 1618 - 3193

Inken Kruse

Alfred-Wegener-Institut für Polar- und Meeresforschung
Wattenmeerstation Sylt
Hafenstraße 43
25992 List
Email: ikruse@awi-bremerhaven.de

Die vorliegende Arbeit ist die inhaltlich unveränderte Fassung einer Dissertation, die 2002 der Mathematisch-Naturwissenschaftlichen Fakultät der Christian-Albrechts-Universität zu Kiel vorgelegt wurde.

Inhalt / Contents

Zusammenfassung.....	3
Abstract.....	5
Chapter 1	
Introduction.....	7
Chapter 2	
Sibling species or poecilogony in the polychaete <i>Scoloplos armiger</i> ?.....	17
Chapter 3	
Reproductive isolation between intertidal and subtidal <i>Scoloplos armiger</i> (Polychaeta, Orbiniidae) indicates sibling species in the North Sea.....	44
Chapter 4	
The role of ecological divergence in speciation between intertidal and subtidal <i>Scoloplos armiger</i> (Polychaeta, Orbiniidae).....	58
Chapter 5	
Discussion.....	77
Danksagung.....	95

Zusammenfassung

Der kosmopolitische Polychaet *Scoloplos armiger* (O. F. Müller, 1776) besitzt in der Nordsee zwei verschiedene Fortpflanzungsweisen. Zusätzlich zu der allgemein bekannten, direkten, holobenthischen Entwicklung aus Laichbeeren, die regelmäßig im Gezeitenbereich zu finden sind, wurden vor Helgoland pelagische Larven gefunden. In Voruntersuchungen zu dieser Arbeit wurden pelagische Larven von *S. armiger* ebenfalls im Wattenmeer vor der Insel Sylt entdeckt, wo auch Laichbeeren sehr häufig vorkommen. Die anfängliche Hypothese, dass sublitorale *S. armiger* pelagische Larven produzieren, wurde in Zuchtexperimenten im Labor bestätigt. Damit war gleichzeitig bewiesen, dass vor Sylt räumlich getrennte Quellen der beiden Fortpflanzungsmodi vorhanden sind.

Um den taxonomischen Status von *Scoloplos armiger* abzuschätzen, wurden unterschiedliche Ansätze und Methoden angewandt. Die Ergebnisse zeigen, dass es sich bei *S. armiger* vor Sylt um zwei sympatrische Geschwisterarten handelt, für die eine Bezeichnung als *S. armiger* 'Type I' für die im Gezeitenbereich lebende Art, und 'Type S' für die Art aus sublitoralen Bereichen, vorgeschlagen wird. Morphologische Vergleiche zwischen frühen benthischen Stadien sublitoraler und eulitoraler Juvenilen ergaben signifikant längere Analcirren bei sublitoralen Tieren. Genetische Untersuchungen (RAPD- und AFLP-PCR) von 3 eulitoralen and 4 sublitoralen Populationen ergaben signifikant unterschiedliche Genpools in den Habitaten (sublitoral/ eulitoral), d.h. die genetische Divergenz war nicht abhängig von räumlicher Distanz sondern von der Unterscheidung im Habitattyp. Kreuzungsexperimente zeigen eine reproduktive Isolation von eu- und sublitoralen *S. armiger*. Paare von Männchen und Weibchen aus verschiedenen Habitaten produzierten keine Nachkommen, während Paare aus dem selben Habitat lebendige Larven hervorbrachten. Pelagische Larven entstanden nur von Paaren mit sublitoralen Männchen und sublitoralen Weibchen, wobei 2 von 14 sublitoralen Weibchen Laichbeeren produzierten. Ansonsten war die Produktion von Laichbeeren immer von der eulitoralen Herkunft der Weibchen abhängig.

Als eine Ursache für eine reproduktive Isolation wurde eine unterschiedliche Spermatozoenmorphologie als Befruchtungsbarriere ausgemacht. Spermatozoen von eulitoralen Männchen hatten doppelt so lange Köpfe und signifikant kürzere Flagellen

als die von sublitoralen Männchen. Eu- und sublitorale *S. armiger* unterscheiden sich außerdem in ökologischen Charakteren. Sublitorale *S. armiger* waren weniger tolerant gegen Hypoxie und Sulfid als eulitorale Tiere. Die gemessene Sulfidexposition war im Sublitoral 5-10 mal niedriger als im Eulitoral. Langzeituntersuchungen zum jahreszeitlichen Auftreten von Laichbeeren und pelagischen Larven zeigen eine Überlappung im Frühjahr, während nur pelagische Larven ein zweites Vorkommen im Herbst aufweisen. Dieses Herbstvorkommen und eine Quantifizierung von pelagischen *S. armiger* im Wattenmeer wird erstmalig beschrieben. Hohe Gesamt-abundanzen von pelagischen Larven im Wattenmeer legen eine Neubewertung der Populationsdynamiken von *S. armiger* nahe.

Abschließend wird diskutiert, wie die heutige Situation von zwei *S. armiger* Geschwisterarten, die sympatrisch, aber mit unterschiedlicher Habitatpräferenz vorkommen, entstanden sein könnte. Dies resultiert in drei Szenarien einer Artbildung in *S. armiger*. Am Schluss steht ein Ausblick auf Artbildungsprozesse im Meer.

Abstract

For the common, cosmopolitan polychaete *Scoloplos armiger* (O. F. Müller, 1776) two developmental modes exist in the North Sea region. In addition to direct, holobenthic development out of egg cocoons, well-known to occur on intertidal flats, pelagic larvae were found around the off-shore island of Helgoland. In this study a preliminary survey revealed that pelagic larvae are also present around the Wadden Sea island of Sylt where egg cocoons are common on intertidal flats. The initial hypothesis of that subtidal *S. armiger* produce pelagic larvae was confirmed by laboratory breeding experiments, proving that around the Island of Sylt spatially separated sources of two developmental modes exist adjacent to each other. The basic question of this study, whether an intertidal and subtidal species of *Scoloplos armiger* exist in the North Sea, was proposed.

Different approaches and methods were used to assess the taxonomic status of *Scoloplos armiger*. All results indicate that there are two sympatric sibling species in *S. armiger*, 'Type I' living in the intertidal zone and 'Type S' living subtidally. Morphological comparison of early benthic stages of intertidal and subtidal juveniles revealed significantly longer anal cirri in subtidal specimens. Genetic study (RAPD- and AFLP-PCR) on 3 intertidal and 4 subtidal populations revealed that genetic divergence is not related to distance but to the intertidal/ subtidal division. Cross breeding experiments show that intertidal and subtidal populations are reproductively isolated. Couples with males and females from different habitats had no offspring while mates from the same habitat produced viable larvae. Pelagic larvae occurred only in couples with subtidal females and subtidal males while egg cocoons were also produced by two out of fourteen subtidal females. Apart from that, production of egg cocoons is determined by female origin from the intertidal zone.

Spermatozoa of intertidal males have heads twice as long and a significantly shorter flagellum than those from subtidal males. It is suggested that deviating sperm morphology may cause the reproductive breakdown at the fertilization stage. Intertidal and subtidal *S. armiger* furthermore exhibit ecological divergence. Tolerance against sulphide and hypoxia were both lower in subtidal than in intertidal specimens. This correlates with a 5 to 10-fold lower sulphide concentration at subtidal compared to intertidal sites. Egg cocoon and pelagic larval spawning period recorded over six years

overlap temporally in spring. Pelagic larvae are released in an additional autumn spawning which is absent for egg cocoons and was unknown till now. High overall abundances of pelagic larvae in the Wadden Sea in this first quantitative record of pelagic *S. armiger* larvae suggest reassessments of *S. armiger* population dynamic models.

It is discussed how the present-day situation with distinct, sympatric species occurring in geographic overlap while exhibiting segregation by habitat may have evolved, resulting in three speciation scenarios for *S. armiger*. In the end an outlook on speciation processes in the sea is given.

Chapter 1

Introduction

In the common polychaete *Scoloplos armiger* (O. F. Müller, 1776) (Fig. 1.1) two distinct modes of development occur in the North Sea region: in addition to the direct, holobenthic development in egg cocoons, well-known to occur on intertidal flats (Gibbs 1968) (Fig. 1.2), a pelagic development via free swimming larvae (Fig. 1.4, Fig. 1.5) has been found around the off-shore island of Helgoland (Plate and Husemann 1991). Holobenthic larvae hatch from the egg cocoons directly into the sediment. An intermediate mode of development does not exist (Fig. 1.3). Both larval types are lecithotrophic.



Fig. 1.1 Adult *Scoloplos armiger*

Recently, pelagic larvae were also found around the island of Sylt (see Chapter 4), where egg cocoons are common as well (Reise 1979; Alpei 1987). Since egg cocoons have not been reported from the subtidal, the initial hypothesis that subtidal *S. armiger* produce pelagic larvae was postulated. In a laboratory breeding experiment (see Chapter 2) this hypothesis was confirmed. Hence, this experiment proved that around the island of Sylt spatially separated sources of two developmental modes exist adjacent to each other. Based on these results the basic question of this study was proposed:

Is *Scoloplos armiger* separated into an intertidal and subtidal species in the North Sea?

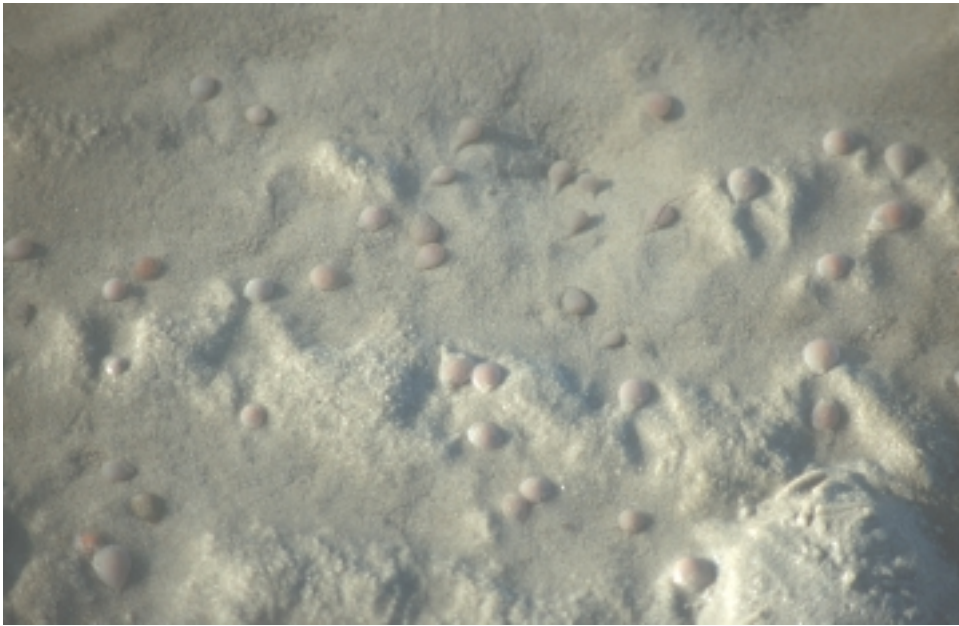

Fig. 1.2 Egg cocoons on the sediment surface of a tidal flat

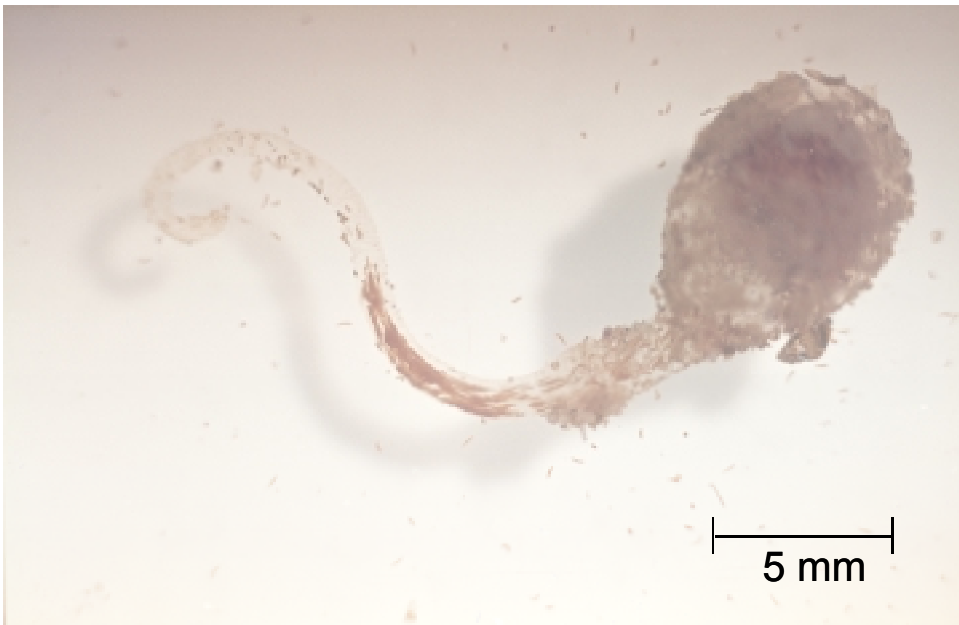

Fig. 1.3 Egg cocoon with hundreds of larvae forming a dark string in the stalk while crawling downwards. Single larvae are visible as dark spots sprinkled around the cocoon

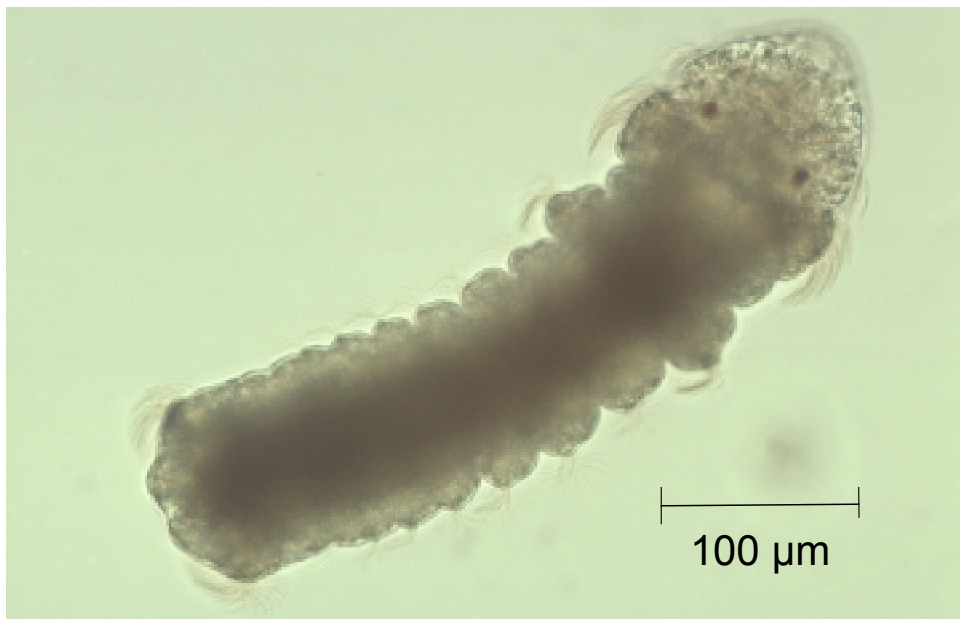

Fig. 1.5 Pelagic larva in dorsal view with seven setigers



Fig. 1.4 Pelagic larva in frontal view

Many marine invertebrates were described to exhibit different modes of development within one species, which has been termed poecilogony (Giard 1905). However, close examination in most cases revealed that sibling species were involved (Hoagland and Robertson 1988; Bouchet 1989). A review of the literature shows that also for *S. armiger* clarification of the taxonomic status is needed. Worldwide ecological studies report *S. armiger* as a single species occurring in the intertidal as well as in the subtidal (Box 1.1). At least for the North Sea region it is unlikely that *S. armiger* has been confounded with other, already described orbiniids. Here, *S. armiger* is the only representative of the genus *Scoloplos* (Blainville 1828) (Hartmann-Schröder 1996).

Box 1.1 Cosmopolitan distribution of *Scoloplos armiger*. References report both intertidal and subtidal occurrences. Providing no information on mode of development, authors payed taxonomic attention to adult morphology only.

All zoogeographic regions	Hartmann-Schröder (1996), p. 598
Arctic	Wesenberg-Lund (1950); Sveshnikov (1960); Holte and Gulliksen (1998)
Alaska, Kodiak Island	Mackie (1987) (<i>Scoloplos armiger alaskensis</i>)
White Sea	Sveshnikov (1960); Burkovsky et al. (1997)
North Sea, Wadden Sea	Dörjes et al. (1986); Niermann et al. (1990); Beukema (1991); Reise et al. (1994)
Mediterranean Sea	Gremare et al. (1998)
Baja California, Mexico	Angel-de-Leon-Gonzalez and Rodriguez (1996)
Australia	Beesley et al. (2000)
Japan	Annenkova (1938)
China	Sun and Yang (1987)
Andaman Sea, Thailand	Frith et al. (1976)

Two studies compare larval morphology of the two developmental types, coming to different conclusions with respect to a species split-up (Box 1.2). Since a spatially segregated source of the two developmental modes was unknown so far, no systematic comparisons between intertidal and subtidal *S. armiger* have been conducted before.

The original *Scoloplos armiger* type species described by Müller (1776) were presumably subtidal specimens. They were sampled at Kristiansand in southern Norway, a rocky shore area in which soft bottom tidal flats are scarce. However, no description on the sampled habitat is given.

Box 1.2 Comparisons between *Scoloplos armiger* larvae with holobenthic and pelagobenthic development

Blake (1980) compares drawings of holobenthic *S. armiger* larvae from the North Sea (Anderson 1959) and of pelagic larvae from the White Sea (Sveshnikov 1960) with those of Orbiniidae from California. He suspects sibling species or misidentification in *S. armiger* after observing that benthic larvae show a metatroch and 3 gastrotrochs while pelagic larvae show no metatroch and 3 gastrotrochs.

Blake (1980) concludes that holobenthic larvae of *S. armiger* more closely resemble those of *Leitoscoloplos pugettensis* than pelagic *S. armiger* larvae, and that pelagic larvae of *S. armiger* are more similar to the larvae of *S. acmeceps* than to holobenthic *S. armiger* larvae.

Plate and Husemann (1991) compare fresh pelagic *S. armiger* larvae with descriptions of holobenthic *S. armiger* larvae (Anderson 1959), both from the North Sea, and find in their plankton material a smaller size and more numerous lateral ciliary bands in the setiger anlagen. Their pelagic larvae settled with 10-11 setigers, egg cocoon larvae hatch at the 9 setiger stage (Anderson 1959).

Plate and Husemann (1991) do not recommend to split *S. armiger* into two separate species.

Testing for a possible speciation process in *S. armiger* is substantial to better assess its population dynamics. Since this species tolerates a wide variety of sediment types it is very widespread, while it is most abundant on intertidal sandflats where it is frequently found in abundances of 400 - 500 Ind. * m⁻² (Linke 1939; Smidt 1951; Michaelis 1969; Reise et al. 1994). *S. armiger* is a mobile, vagile infaunal subsurface deposit feeder, reaching 12 cm in length (Fauchault and Jumars 1979; Hongguang et al. 1995; Hartmann-Schröder 1996). It builds non-persisting tubes in the sediment down to 15 cm below surface. The species is gonochoristic, reproduces not before its second year and spawns in spring (Gibbs 1968; Plate and Husemann 1991). As prey for flatfish (Smidt 1951) and as the main prey item for the polychaete *Nephtys hombergii*, which is an important food for fish (Schubert and Reise 1986), *S. armiger* may gain economic significance. In the Eastern Gotland and Northern Basins of the Baltic, *S. armiger* plays an important role in ecosystem functioning. It is the only representative of macrofauna involved in the bioturbation process of large suboxic areas below the subhalocline (Olenin and Schiedek 1996).

In cases of suspected speciation different approaches are used to assess the status of the speciation process. The choice of an approach depends on which concept is followed and which questions are posed. According to the morphological species concept, discrete quantifiable phenotypic characters are searched for to discriminate between populations or species, providing diagnostic criteria for routine identification. In the biospecies concept, experimental and field data on reproductive isolation are required to define distinct species (Mayr 1963), allowing estimations on realized interbreeding in the natural environment. Direct measures of the isolation of gene pools are provided by molecular tools. They may reveal genetic population processes during species divergence and represent a tool to assess the relative significance of genetic *versus* environmental sources of variation. The new model of ecological speciation combines molecular and environmental data and revives the role of selection as a potent force to disrupt species (Orr and Smith 1998; Morell 1999; Schluter 2001).

Since every approach has its assets and drawbacks and does not provide absolute "measures of speciation", a combination of different approaches and examining the consistency of results appears as a promising strategy (Gosling 1994). Which method in the end may provide diagnostic characters to discriminate between species also depends on the context which is involved. Species can be morphologically similar but genetically distinct like the polychaete species complex *Capitella* (Grassle and Grassle 1976) or *vice versa*, as found in European and American lobster species (Hedgecock et al. 1977) and in four species of sea urchins (Palumbi and Metz 1991). Especially sibling species withstand morphological characterization since they are by definition "morphologically similar or identical natural populations that are reproductively isolated" (Mayr 1963, p. 34).

Knowledge on speciation in the sea is only beginning to emerge (Palumbi 1992; Palumbi 1994; Gosling 1994). Ignorance of the basic biology of most marine species is certainly one cause why marine biologists have not been at the forefront in the debate on species concepts. This reflects on the one hand that marine species are less accessible for observation in their natural environment than terrestrial species. On the other hand, the highly dispersive nature of the marine habitat makes assessments of connectivity and exchange rates between and within populations difficult. Many marine macroinvertebrates broadcast their larval stages via water currents.

Application of novel molecular markers turned out to be a promising method to partially fill the mentioned gaps. Many studies examine the basic questions of dispersal, fundamental not only in marine speciation processes. One widely used approach in the study of marine invertebrates is to elucidate how the realized dispersal of a species is dependent on life-history or mode of development (e.g. Crisp 1978; Burton and Feldman 1982; Hoskin 1997; Chambers et al. 1998). Spatial patterns of genetic diversity of species with similar biology but contrasting life-histories are compared. Since development out of egg cocoons implies a lower dispersal range than that of pelagic larvae (Chapman 1965; Gibbs 1968; Plate and Husemann 1991), *Scoloplos armiger* represents a species of interest also in this context.

In this study, the question on the existence of two *Scoloplos armiger* species was split into four subquestions corresponding to the different approaches and methods applied:

1. Are there distinct gene pools in intertidal and subtidal *Scoloplos armiger*? (Chapter 2)
2. Are intertidal and subtidal *Scoloplos armiger* reproductively isolated? (Chapter 3)
3. What is the mechanism of reproductive isolation? (in part Chapter 3 and 4)
4. Are there differential physiological adaptations in intertidal and subtidal individuals? (Chapter 4)

One further question among others is awaiting detailed investigation:

Are there overlooked diagnostic characters in the morphology of intertidal and subtidal populations?

Analysis of intertidal and subtidal populations of *Scoloplos armiger* in this study consists of four approaches with (1) genetic study (RAPD- and AFLP-PCR), (2) cross breeding experiments, (3) aspects of sperm morphology and morphology of benthic juveniles and (4) physiological tolerance of anoxia and sulphide.

References

- Alphei J (1987) Verteilung, Mortalität und Feindspektrum juveniler *Scoloplos armiger* (Polychaeta) im Sandwatt der Nordsee. Diploma thesis. Universität Göttingen
- Anderson DT (1959) The embryology of the polychaete *Scoloplos armiger*. Q Jl microsc Sci 100:69-166
- Angel-de-Leon-Gonzalez J, Rodriguez JA (1996) Orbiniidae (Polychaeta) from soft bottom of the western coast of Baja California Peninsula, Mexico. Bull Mar Sci. 59:169-174
- Annenkova NP (1938) Polikhetai severnoi chasti iaponskogo moria i ikh fatsial'noe i vertikal'noe raspredelenie - Polychaeta of the North Japan Sea and their horizontal and vertical distribution. Gidrobiol eksped 1934 g. Iaponskoje More. Trudy 1:81-230
- Beesley PL, Ross GJB, Glasby CJ (2000) Polychaetes & Allies: The Southern Synthesis. Fauna of Australia. Vol. 4 A. Polychaeta, Myzostomida, Pogonophora, Echiura, Sipuncula. CSIRO Publishing, Melbourne
- Beukema JJ (1991) Changes in composition of bottom fauna of a tidal-flat area during a period of eutrophication. Mar Biol 111:293-301
- Blake JA (1980) The larval development of Polychaeta from the northern California coast IV. *Leitoscoloplos pugettensis* and *Scoloplos acmeceps* (Family Orbiniidae). Ophelia 19:1-18
- Bouchet P (1989) A review of poecilogony in gastropods. J Molluscan Stud 55:67-78
- Burkovsky IV, Udalov AA, Stoljarov AP (1997) The importance of juveniles in structuring a littoral macrobenthic community. Hydrobiologia 355:1-9
- Burton RS, Feldman MW (1982) Population genetics of coastal and estuarine invertebrates: does larval behaviour influence population structure? In: Kennedy VS (ed) Estuarine Comparisons. Academic Press, New York, pp 537-551
- Chambers RJ, McQuaid CD, Kirby R (1998) The use of randomly amplified polymorphic DNA to analyze the genetic diversity, the systematic relationships and the evolution of intertidal limpets, *Siphonaria* spp. (Pulmonata: Gastropoda), with different reproductive modes. J Exp Mar Biol Ecol 227:49-66
- Chapman G (1965) The egg cocoons of *Scoloplos armiger* O. F. Müller. Biol Bull (Woods Hole) 128:189-197
- Crisp DJ (1978) Genetic consequences of different reproductive strategies in marine invertebrates. In: Battaglia B, Beardmore JA (eds) Marine organisms: genetics, ecology, and evolution. Plenum Press, New York, pp 257-273
- Dörjes J, Michaelis H, Rhode B (1986) Long-term studies of macrozoobenthos in intertidal and shallow subtidal habitats near the island of Norderney (East Frisian coast, Germany). Hydrobiologia 142:217-232

- Fauchault K, Jumars PA (1979) The diet of worms: a study of polychaete feeding guilds. *Oceanogr Mar Biol Annu Rev* 17:193-284
- Frith DW, Tantanasiwong R, Bhatia O (1976) Zonation of macrofauna on a mangrove shore, Phuket Island. *Res Bull Phuket Mar Biol Cent* 10:1-37
- Giard AC (1905) La poecilogonie. 6th International Congress of Zoology:617-646
- Gibbs PE (1968) Observations on the population of *Scoloplos armiger* at Whitstable. *J mar biol Ass UK* 48:225-254
- Gosling EM (1994) Speciation and species concepts in the marine environment. In: Beaumont AR (ed) *Genetics and evolution of aquatic organisms*. Chapman & Hall, London
- Grassle JP, Grassle JF (1976) Sibling species in the marine pollution indicator *Capitella* (Polychaeta). *Science* 192:567-569
- Gremare A, Amouroux, J. M., and Vetion, G. (1998) Long-term comparison of macrobenthos within the soft bottoms of the Bay of Banyuls-sur-mer (northwestern Mediterranean Sea). *J Sea Res* 40:281-302
- Hartmann-Schröder G (1996) *Polychaeta*. G. Fischer, Stuttgart
- Hedgecock D, Nelson K, Simons J, Shleser R (1977) Genetic similarity of American and European species of the lobster *Homarus*. *Biol Bull (Woods Hole)* 152:41-50
- Hoagland KE, Robertson R (1988) An assessment of poecilogony in marine invertebrates: phenomenon or fantasy? *Biol Bull (Woods Hole)* 174:109-125
- Holte B, Gulliksen B (1998) Common macrofauna dominant species in the sediments of some north Norwegian and Svalbard glacial fjords. *Polar Biol* 19:375-382
- Hongguang M, Zhiying Y, Cadée GC (1995) Macrofauna distribution and bioturbation on tidal confluences of the Dutch Wadden Sea. *Neth J Aquat Ecol* 29:167-176
- Hoskin MG (1997) Effects of contrasting modes of larval development on the genetic structures of populations of three species of prosobranch gastropods. *Mar Biol* 127:647-656
- Linke O (1939) Die Biota des Jadebusenwattes. *Helgol wiss Meeresunters* 1:201-348
- Mackie ASY (1987) A review of species currently assigned to the genus *Leitoscoloplos* Day, 1977 (Polychaeta, Orbiniidae), with descriptions of species newly referred to *Scoloplos* Blainville, 1828. *Sarsia* 72:1-28
- Mayr E (1963) *Animal species and evolution*. Harvard University Press, Cambridge
- Michaelis H (1969) Makrofauna und Vegetation der Knechtsandwatten. Jahresbericht 1967, Report of Forschungsst. Norderney 19:147-173
- Morell V (1999) Ecology returns to speciation studies. *Science* 284:2106-2108

- Müller OF (1776) *Zoologica Danicae Prodomus seu Animalium Daniae et Norvagiae indigenarum characters, nomine, et synonyma imprimis popularium*. Havniae xxxii:274 pp., Taf. 1777
- Niermann U, Bauerfeind E, Hickel W, v. Westernhagen H (1990) The recovery of benthos following the impact of low oxygen content in the German Bight. *Neth J Sea Res* 25:215-226
- Olenin S, Schiedek D (1996) Is the polychaete *Scoloplos armiger* a biological marker of saline water inflows into subhalocline areas of the Baltic proper? *Baltic Marine Science Conference*. Rønne, Bornholm. Abstracts, p. 3
- Orr MR, Smith TB (1998) Ecology and speciation. *Trends Ecol Evol* 13:502-506
- Palumbi SR (1992) Marine speciation on a small planet. *Trends Ecol Evol* 7:114-118
- Palumbi SR (1994) Genetic divergence, reproductive isolation, and marine speciation. *Ann Rev Ecol Syst* 25:547-572
- Palumbi SR, Metz EC (1991) Strong reproductive isolation between closely related tropical sea urchins (genus *Echinometra*). *Mol Biol Evol* 8:227-239
- Plate S, Husemann E (1991) An alternative mode of larval development in *Scoloplos armiger* (O. F. Müller, 1776) (Polychaeta, Orbiniidae). *Helgol Meeresunters* 45:487-492
- Reise K (1979) Spatial configurations generated by motile benthic polychaetes. *Helgol Meeresunters* 32:55-72
- Reise K, Herre E, Sturm M (1994) Biomass and abundance of macrofauna in intertidal sediments of Königshafen in the northern Wadden Sea. *Helgol Meeresunters* 48:201-215
- Schluter D (2001) Ecology and the origin of species. *Trends Ecol Evol* 16:372-380
- Schubert A, Reise K (1986) Predatory effects of *Nephtys hombergii* on other polychaetes in tidal flat sediments. *Mar Ecol Prog Ser* 34:117-124
- Smidt ELB (1951) Animal production in the Danish Waddensea. *Medd Danm Fisk Havunders (Ser Fiskeri)* 11:1-151
- Sun R, Yang D (1987) Studies of Orbiniidae (Polychaeta) from the Yellow Sea and the East China Sea. *Stud Mar Sin/Haiyang Kexue Jikan* 28:151-168
- Sveshnikov VA (1960) Pelagic larvae of some polychaeta in the White Sea. *Zool Zh* 39:343-355
- Wesenberg-Lund E (1950) The polychaeta of West Greenland. *Medd Grönland* 151:1-171

Chapter 2

Sibling species or poecilogony in the polychaete *Scoloplos armiger*?

Inken Kruse, Thorsten Reusch, Vicky Schneider

Abstract

In marine invertebrates multiple modes of development may occur in a single species and this has been termed poecilogony. However, after close examination, many of such putative cases turned out to be sibling species. For the cosmopolitan orbiniid polychaete *Scoloplos armiger* of marine shallow sediments, in addition to the well-known direct, holobenthic development out of egg cocoons also pelagic larvae have been described. Our culture experiments revealed a spatially segregated source of the two developmental modes. All females of an intertidal population produced egg cocoons and no pelagic larvae. All but two out of 15 females of an adjacent subtidal population produced pelagic larvae. Based on these results we performed a molecular genetic analysis (RAPD-PCR) on 3 intertidal and 4 subtidal populations in the North Sea. Selected samples from all sites were analysed also by the AFLP method. Genetic divergence is not related to distance but to the intertidal/subtidal division. We propose that developmental modes are genetically fixed and hypothesize reproductive isolation between intertidal and subtidal populations, indicating sibling species in *S. armiger*. We also found significantly higher genetic diversity within subtidal than within intertidal populations. This is consistent with a wider dispersal by pelagic larvae and a smaller effective population size when development is holobenthic. An odd result is that among subtidal localities genetic differences exceed those between intertidal localities. We suggest that speciation processes in marine invertebrates are facilitated by switches in developmental modes.

Introduction

For benthic marine invertebrates existence of different modes of development within one species has been shown several times and is termed poecilogony (Giard 1905). In fact, re-examination of supposed poecilogonous species in most cases revealed misidentification or laboratory disturbance and later a split-up into sibling species was necessary (Hoagland and Robertson 1988; Bouchet 1989). It appears that shifts in developmental mode play an important role in speciation processes in the marine habitat. Shifts may be rapid and complete within local populations, affect dispersal and this may lead to reproductive isolation and speciation (Hoagland and Robertson 1988). Currently, marine species represent a challenge to the idea of allopatric speciation. Generally, rates of dispersal and gene flow are assumed to be high (Palumbi 1994).

A central question in species assumed to be poecilogonous is whether individuals are able to switch between developmental modes relative to environmental conditions, or if the mode of reproduction is genetically fixed with no individual flexibility. Checking environmental factors as external triggers for a developmental mode needs a lot of effort since many interconnected causes and effects have to be considered. In extensive studies on the polychaete *Streblospio benedicti* a network of life-history trait correlations was observed defining two distinct modes of development, planktotrophy and lecithotrophy. Some reproductive traits were detected to shift depending on the environment and some were genetically fixed (Levin et al. 1991). Finally, sequencing of mitochondrial DNA revealed that this species also has to be divided into two separate species: *Streblospio benedicti* and *S. gynobranchiata* (Schulze et al. 2000), with *S. benedicti* still comprising planktotrophic and lecithotrophic larval types.

In *Scoloplos armiger*, one of the most common macrofauna species in sediments of the eastern North Atlantic coastal seas, occurrence of two distinct modes of development became apparent recently. *S. armiger* is reported to have a cosmopolitan distribution (Hartmann-Schröder 1996) and is present from the intertidal down to the deep subtidal (Gibbs 1968; Holte 1998). Spawning of this polychaete has usually been described to be benthic: conspicuous egg cocoons are laid on the sediment surface of intertidal mud flats, fixed with a stalk. Through this stalk juvenile worms crawl directly into the sediment when they have developed to a 9 setiger stage (Anderson 1959). Only a decade ago an additional mode of reproduction has been attributed explicitly to *S. armiger* by Plate and Husemann (1991). They describe pelagic larvae occurring

around the off-shore island of Helgoland, North Sea. These are distinct from egg cocoon larvae by (1) showing more ciliary bands which gives them the ability to swim actively and (2) by their smaller size when comparing larvae of similar setiger numbers (Anderson 1959; Plate and Husemann 1991). Both pelagic and benthic larvae are lecithotrophic. Earlier findings of *S. armiger* larvae in the plankton have been addressed to eroded benthic stages or were not further discussed (Sveshnikov 1960; Giere 1968; Jägersten 1972; Bosselmann 1991). At a 10-11 setiger size pelagic larvae undergo metamorphosis and settle on the sea floor (Plate and Husemann 1991). This mode of development is here called pelago-benthic whereas development in egg cocoons is assigned to be holobenthic (Jägersten 1972). Since around the island of Helgoland for *S. armiger* no suitable intertidal soft bottom habitats exist (Gillandt 1979; Janke 1986), it remains unknown where these pelagic larvae come from. Though *S. armiger* is very common in adjacent subtidal sediments, egg cocoons have neither been reported nor seen by staff of local research vessels or by divers (pers. comm.). Apparently, subtidal *S. armiger* seem not to reproduce via egg cocoons.

Recently, pelagic larvae of *S. armiger* were recorded also around the island of Sylt in an even higher density than near Helgoland (up to 30 larvae per 10 l water sample; Kruse, unpubl. data). In contrast to Helgoland, Sylt is located within the sedimentary Wadden Sea and therefore surrounded by suitable intertidal sediments for *S. armiger*. Thus, at Sylt either both modes of reproduction co-exist or pelagic larvae drift from distant offshore regions into the Sylt area. In the present study we examined the provenance of pelagic larvae near Sylt. We hypothesize that pelagic larvae originate from subtidal sites. In laboratory we cultured adult worms ready to spawn to test if pelagic larvae of *S. armiger* emerge from subtidal adults and if intertidal adults produce egg cocoons only.

It is a promising approach to compare geographic patterns of phenotypes with those of genotypes. It is examined whether isolation mechanisms for genetic exchange other than isolation by distance exist. Therefore, when testing causes of poecilogony, geographic patterns of developmental modes are important to know. In a study of the polychaete *Boccardia proboscidea* exhibiting two developmental modes, RAPD-PCR examination revealed that genetic variance was attributable to geographic origin and not to developmental type, demonstrating that *B. proboscidea* exhibits real poecilogony (Gibson et al. 1999). In *B. proboscidea* separation of individuals with different developmental modes prior to genetic analysis was done using morphological

characteristics. In *S. armiger* we found no character available allowing to predict which type of reproduction will be performed by an individual. Thus, genetic analysis using random amplified polymorphic DNA (RAPD) (Williams et al. 1990) was based on separation of developmental modes by habitat type, according to our presumptions and results of our laboratory experiment.

Genetic diversity of *S. armiger* with respect to developmental mode and geographic distribution within the Sylt area was analysed. Samples from one location at Helgoland with postulated pelago-benthic development was used for comparison with Sylt locations and also as a distant reference population.

Materials and methods

To test the initial hypothesis that pelagic larvae originate from the subtidal habitat and that intertidal adults produce egg cocoons only, *S. armiger* from both habitats were cultured separately in the laboratory until spawning in February / March 1998. Results allowed us to accept this hypothesis. Based on this the subsequent genetic study was performed in search of further differences between subtidal and intertidal *S. armiger*.

Study area

This study was conducted on *Scoloplos armiger* in the Sylt-Rømø Bight, an enclosed tidal basin in the northern Wadden Sea and near the island of Helgoland further offshore in the North Sea (Fig. 1.1). At both areas tides are semidiurnal with a range of 2 to 2.4 m. The Sylt-Rømø Bight covers about 400 km², of which 33% belong to the intertidal zone, 57% to the shallow subtidal (<5m depth) and 10% to deeper tidal channels (max. depth ~ 40m). Water exchange between the Sylt-Rømø Bight and the open North Sea takes place through a 2.8 km-wide tidal channel called the Lister Deep. More information about the area is given in Gätje and Reise (1998).

Origin-of-larvae experiment

Specimens of *S. armiger* from the subtidal and from the intertidal were collected at locality "Odde" (shown in Fig. 2.1) in January/ February 1998, i.e. before spawning when males and females could be distinguished easily by their well developed gonads. Individuals from the same habitat, five females and three males each, were put together in one aquarium. Both habitats were replicated three times. All six aquaria (55x40x30 cm) contained 7 cm of sediment from the subtidal habitat, sieved through

1 mm, covered with 20 cm sea water. Placed in a culture room, aquaria were aerated and were subject to artificial light in day-night rhythm. Temperature was adjusted to the concurrent water temperature in the field (5-7°C). Each day we recorded deposition of egg cocoons by eye and occurrence of pelagic larvae and eggs by sampling the water column. The latter was done using a tube to take a representative 10 l water sample from each aquarium and to filter it through a 80 µm mesh.

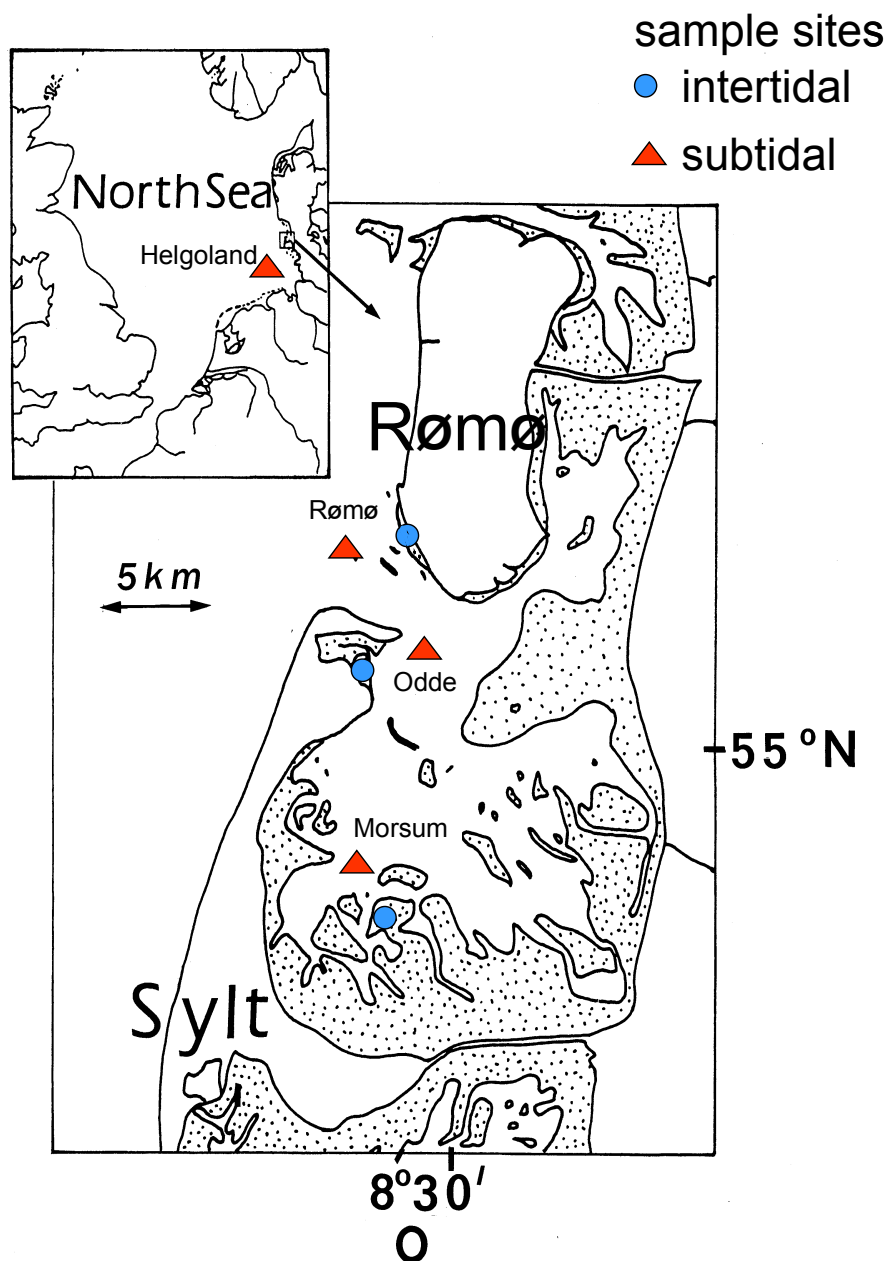

Fig. 2.1 Sampling design to test genetic differentiation according to geographic locations ("Odde", "Morsum", "Rømø", "Helgoland") against differentiation according to habitat (subtidal, intertidal)

Sampling for genetic study

Worms for DNA analysis were collected in July/August 2000 around the island of Sylt within each of three localities ("Odde", "Morsum", "Rømø") at one intertidal and one subtidal site (Fig. 2.1). This sampling was designed to test if larger differences exist between sites within localities (i.e. between intertidal and its adjacent subtidal habitat) than between different localities (within subtidal and intertidal habitats) situated further away from each other. In other words, the hypothesis of isolation by distance of localities was tested against isolation by type of habitat. Additionally, one site near the offshore island of Helgoland was sampled as a distant subtidal site where the *Scoloplos armiger* population was supposed to exhibit the pelago-benthic mode of reproduction. In this context it was tested whether individuals from the locality "Helgoland" were more similar to subtidal Sylt specimens than to intertidal ones. Positions of all sites are given in Table 2.1. Distances between the sampling areas Helgoland and Sylt are about 95 km and within the Sylt area between the localities Morsum and Odde 9 km, Odde and Rømø 7.3 km and Rømø and Morsum 16.1 km. Habitats within localities (intertidal and subtidal sites) were 2 - 2.5 km apart from another. *S. armiger* was sieved out of the sediment, sorted alive and isolated in sea water for at least 24 hours to allow the gut contents to be digested. Then worms were frozen to -80 °C.

Table 2.1 Position of sites, water depths (metres below spring low tidal level) and number of sampled *Scoloplos armiger*. "Intertidal": mid intertidal zone; sampled randomly on 10x10 m. "Water depth" in metres below spring low tide level

Site	Abbreviation	Position	Water depth	Number of individuals
Sylt				
<u>intertidal</u>				
Morsum	E M	54° 56,26 N; 08° 26,90 E	0	11
Odde	E O	55° 01,09 N; 08° 26,00 E	0	12
Rømø	E R	55° 05,65 N; 08° 27,75 E	0	12
<u>subtidal</u>				
Morsum	S M	54° 57,13 N; 08° 26,40 E	5	12
Odde	S O	55° 01,47 N; 08° 27,98 E	10	12
Rømø	S R	55° 05,90 N; 08° 26,01 E	6	11
Helgoland				
<u>subtidal</u>	SH	from 54° 17,00 N; 7° 48,00 E to 54° 16,20 N; 7° 47,20 E	20	21
Σ				91

DNA extraction

DNA was extracted from frozen adult worms with the spin-column method DNeasy® Tissue Kit (Quiagen), using 20-25 mg of the front ends. Following the DNeasy protocol for animal tissues, a RNase-A digestion step was included and the elution was done once with 100µl buffer AE.

RAPD procedure

Thirty arbitrary decamer primers from the kits A (OPA -01 - OPA -10) and B (OPB-01 - OPB-20) of Operon and 5 of the RAPD Primer SET #4 of Biotechnology Laboratory were tested (Operon Technolg. Inc., CA, USA; Biotechnology Laboratory, University of British Columbia, BC, Canada). The codes of the four primers which gave satisfying results (several bright, clear bands for most of the samples) were: OPA-02, -03, -09, -10. For PCR, vials were placed in a Biometra T Gradient thermocycler for an initial of 3 min at 94°C, then cycled 10 times through 1 min at 94°C, 1 min at 35°C and 1 min at 72°C, followed another cycle of 30 times through 30 sec at 94°C, 30 sec at 35°C and 1:30 min at 72°C, finally paused at 72°C. The reaction volume (20 µl) contained 2 µl of each 10x dNTP (Roche), 5 µM primer, 1% BSA, 25 mM MgCl₂, Storage Buffer B (20 mM Tris-HCL, pH 8,0; 100mM KCL; 0,1 mM EDTA; 1mM DTT; 50% Glycerol; 0,5% Nonidet-P40; 0,5% Tween 20) and 0.15 µl Taq DNA polymerase (size 100 units, 5 U/µl) (the latter three chemicals by Promega, Madison / USA), 1 µl of DNA template solution and 8.85 µl HPLC-water. Each PCR was run with all samples for one primer placing two of subtidal and intertidal samples each in alternate order in 96-well microtiter dishes and adding one replicate and one blank. The replicates were samples from one worm divided into two pieces prior to DNA extraction. All replicates indicated reproducibility. Amplified RAPD products (8 µl) were loaded on 2.5% agarose gels with two of subtidal and intertidal samples each in alternate order. They were analysed by gel electrophoresis (200 V for 2:20 - 3 h) in 1 x TAE buffer. A 100 base pair ladder (Amersham Pharmacia Biotech), thinned to 0.1 x, was used as size standard. Gels were stained in an ethidium bromide bath (0.5 µg/ml) and recorded using a CCD video camera system with an image processing workstation (GeneSnap by Syngene, Synoptics, Ltd., Cambridge, England). In gel images printed from GeneTools (Syngene) the presence and absence of bands were scored visually. Only bands larger than 400 bp size were considered in the analysis.

Data analysis

0/1 matrices representing the two states (presence/ absence) of RAPD bands were obtained for each primer and entered first into TREECON (Van de Peer and De Wachter 1994) to calculate genetic distances using the Nei-Li distance coefficient. The advantage of Nei-Li distance estimates is that they use only the shared presence of a band (assuming homology) (Nei and Li 1979; Harris 1999), which is appropriate for RAPD data (Lambooy 1994; Wolfe and Liston 1998). Since RAPD bands are scored as dominant markers, for presence of a band one can make a basic assumption that the priming loci on either allele are present. The absence of a band can result from several phenomena (substitution, deletion, insertion, restriction site absent, etc.). UPGMA and neighbour joining (NJ) trees were constructed based on genetic distances in TREECON (Sneath and Sokal 1973). Means of Nei-Li genetic distances were also calculated for each single site. Analysis of molecular variance (AMOVA) (Excoffier et al. 1992) was further employed to test differentiation between localities against differentiation between habitats. From the frequency of RAPD products, patterns of diversity were calculated for a pre-defined group structure. Data at first level were grouped according to localities and at second level according to habitat. Φ_{st} -statistics (analogous to Wright's F_{st}) and test of significance (1023 permutations) was performed in ARLEQUIN version 2.0 (Schneider et al. 2000). AMOVA has the advantage that it does not require the normality assumption as classical ANOVA does.

As another test for group structure, the dataset was analysed by the software Tools for Population Genetic Analysis (TFPGA) (Miller 1997) after it was converted to pseudohaploid inputs, due to the dominant nature of RAPD. In TFPGA F -statistics using the methods of Weir and Cockerham (1984) was calculated on the same two-level hierarchy structure as in AMOVA, habitats grouped within locality. 95% confidence intervals (CI) for Φ (analogous to Φ in AMOVA and Wright's F_{st}) were achieved by bootstrapping across loci with 1000 replications.

However, AMOVA assumes Hardy-Weinberg equilibrium, which cannot be determined by the dominant RAPD data. For this reason, an additional frequency measure, Shannon's index of diversity, was determined since it does not rely on Hardy-Weinberg equilibrium (Bussell 1999). It was calculated as described in Engelen et al. (2001) and according to Bussell (1999) following the equation

$$H'_j = -\sum p_i \log_2 p_i$$

where p_i is the frequency of the presence or absence of a RAPD band (i.e. locus) in that site. H'_j values were averaged per primer across sites [$H'_{pop} = 1/(n\sigma H'_j)$] and per site across primers. Shannon's index served as estimation of i) diversity components within and between sites. ii) diversity detected by different primers within sites. iii) site-related differences in genetic diversity. iv) differences in total genetic diversity within sites between intertidal and subtidal *S. armiger* (Shannon-indices compared by *t*-test using STATISTICA 5.1) (Chalmers et al. 1992; Engelen et al. 2001).

Genetic diversity among and within Sylt sites was also compared between habitats using Nei-Li genetic distances out of TREECON. For each individual the mean of genetic distances i) to each of all other individuals of the same site and ii) each of individuals of different sites of the same habitat were calculated. These means (35 within sites for each habitat and 70 between sites for each habitat) were compared between habitats using ANOVA from STATISTICA 5.1.

AFLP analysis

Amplified fragment length polymorphism (AFLP) technique (Vos et al. 1995) was performed from the same DNA extracts as the RAPDs on some selected samples to test for consistency of results by both methods. AFLP is considered a reliable and powerful tool for the evaluation of genetic variability with better reproducibility than RAPD (Jones et al. 1997). The AFLP procedure involved 3 main steps. (i) Restriction of the DNA and ligation of adapters. For each sample, approximately 250 ng of DNA was digested with 4 units of Mse/EcoRI restriction enzyme in a reaction volume of 20 μ l. In the same reaction, ligation was done with 6 units of DNA ligase and 100ng/ μ l adapters. After incubation at 37°C for 2 hours, samples were transferred to a 65°C water bath for 5 minutes in order to inactivate the DNA ligase. Incomplete digestion of genomic DNA can lead to false polymorphism in AFLP profiles. Therefore complete digestion was confirmed by running each sample on an agarose gel. We also checked whether each enzyme in the absence of the other led to complete digestion. (ii) Pre-amplification PCR: 2,5 μ l of the restriction-ligation product was combined with 17,5 μ l of pre-amplification primer solution, using the AFLP core mix (Perkin Elmer). The primers used were Eco+A and Mse+C. PCR consisted of 20 cycles of 94°C for 1s, 56°C for 30s, and 72°C for 2 min terminated by a single step of 60°C for 30 min using

a MJ-PCR thermocycler. After checking for the presence of a smear by agarose electrophoresis, the pre-amplification mixture was diluted 1:19 with TE buffer. (iii) Selective amplification: primers that match the known adapter sequence plus three selective nucleotides were used to reduce the number of amplified fragments. Two primer combinations were identified as yielding many polymorphic fragments, Mse-CAC and the fluorescently labeled Eco RI primers Ned-CAT and Joe-AGG. A touchdown PCR reaction was used with one cycle of 94°C for 2 min, 65°C for 30s, and 72°C for 2 min followed by 23 cycles in which the annealing temperature was reduced with 1°C steps to 56°C, again followed by a single step of 60°C for 30 min.

For gel electrophoresis 2µl of the selective amplification was added to a 3µl mixture of formamide, loading buffer, and size standard (GeneScan 1000 Rox, Perkin Elmer). The amplified labeled fragments were analyzed on 5% Long Ranger polyacrylamide gels, using an ABI Prism 377 automated genetic analysis system (Perkin Elmer). Data were processed using ABI GeneScan Analysis 3.1 software (Perkin Elmer). Each sample was manually checked for correct aligning of the size standard and when necessary aligned by hand. Data were subsequently imported into: Genographer (<http://hordeum.oscs.montana.edu/genographer>) and AFLP profiles scored for the presence/ absence of fragments between 50 and 500bp. Reproducibility was tested for one individual by repeating the DNA extraction and AFLP procedure and found to be high (98%). In Genographer we used the Thumbnail option to visually score the presence and absence of bands and obtain 0/1 matrices. As described for the RAPDs, an UPGMA tree was constructed in TREECON.

Results

Provenance of pelagic larvae

The culturing experiment revealed that pelagic larvae were only produced by *S. armiger* of subtidal origin. From the 15 intertidal females 14 egg cocoons were formed while this was the case in only two of the 15 females from the subtidal population. In all three aquaria with subtidal specimens eggs appeared first in the water column and several days later trochophora and larvae as described by Plate and Husemann (1991) were found. Larvae emerged in calculated total maximum numbers of 255, 493 and 1540 respectively per five females and aquarium. Specimens from both habitats spawned during a period of two weeks in 1998, intertidals from Feb 21 to Mar 7,

subtidals from Feb 25 to Mar 10. In conclusion, the habitat (subtidal / intertidal) turned out as a suitable approximation to separate the two modes of development from each other. Thus, in the genetic study habitats are used to differentiate between populations of *S. armiger*. This was done in awareness that some egg-cocoon producing females are obviously mixed up with the subtidal material, representing a mistake transmitted into further results.

Analysis of RAPD

Genetic variability

With four decamer primers 116 polymorphic bands were scored in total, none were monomorphic. An example of RAPD patterns is given by Fig. 2.2.



Fig. 2.2 RAPD marker pattern of eight individual *Scoloplos armiger* using primer OPA 2 from location "Rømø" (S subtidal specimen; E intertidal specimen; M molecular, 100 bp weight marker)

Per primer between 28 and 32 bands appeared (Table 2.2) with a length from 300 to 2300 base pairs. Each of the 91 individuals showed a unique RAPD band profile. There were 48 bands specific for the subtidal habitat and none for the intertidal. Due to PCR failure for each primer some samples (individuals) had to be omitted, thus 9.6% of the data was missing.

Table 2.2 RAPD primers used

primer	sequence 5' to 3'	total No of bands
OPA 2	TGC CGA GCT G	28
OPA 3	AGT CAG CCA C	32
OPA 9	GGG TAA CGC C	29
OPA 10	GTG ATC GCA G	27
Avg. bands per primer		29
Total bands		116

AMOVA and Shannon's index analyses showed consistent results in that most of the variation occurred within sites (81% respectively 89%) and less between sites (22% respectively 11%). Primers varied in their power to detect variation within and between sites, as indicated by Shannon's index for diversity (H'_{pop}) calculated per primer per site and per primer across all sites (Table 2.3). Average multi-locus diversity per sites was 0.889, ranging from 0.37-1.59. Only primer OPA 3 detected more diversity between than within sites.

Table 2.3 Shannon's indices for genetic diversity between and within sites for four random oligonucleotide primers.

primer	H'_{pop}	H'_{sp}	H'_{pop}/H'_{sp} (within sites)	$1-(H'_{pop}/H'_{sp})$ (between sites)
OPA 2	1.598	1.621	0.986	0.014
OPA 3	0.727	1.936	0.375	0.625
OPA 9	1.018	1.694	0.601	0.399
OPA 10	2.086	1.309	1.594	-0.594
Mean	2.854	1.245	0.889	0.111
Total	19.976	6.559	3.557	0.443

Genetic structure and partitioning of genetic variance

Population structure was analysed by several statistical methods. Distance values obtained according to Nei and Li (1979) are illustrated by the tree based on cluster analyses with the UPGMA method (Fig. 2.3), where each sample is clustered individually.

The tree shows that intertidal and subtidal *S. armiger* each cluster together, indicating that the genetic distances are smaller within the same type of habitat (intertidal, subtidal) than within localities ("Odde", "Morsum", "Rømø") across habitats. As an exception, five subtidal individuals from Morsum are among the intertidal group. These individuals might be intertidal *S. armiger* which have migrated into the subtidal. As mentioned above, separation of developmental modes by habitat type is not strict. Helgoland specimens group closer together with the subtidals than with the intertidals from Sylt, and also closer than subtidals with their respective neighbouring intertidals of the same locality. Within habitats a slight grouping according to locality is shown (Fig. 2.3). Cluster analysis of the same data set by the neighbour-joining method (NJ) gave similar results. In trees of both clustering methods bootstrap values are quite low but are counterbalanced by the clear pattern resolved. In conclusion, Nei-Li distances show a clear grouping of individuals according to habitat (subtidal, intertidal) and none according to geographic origin.

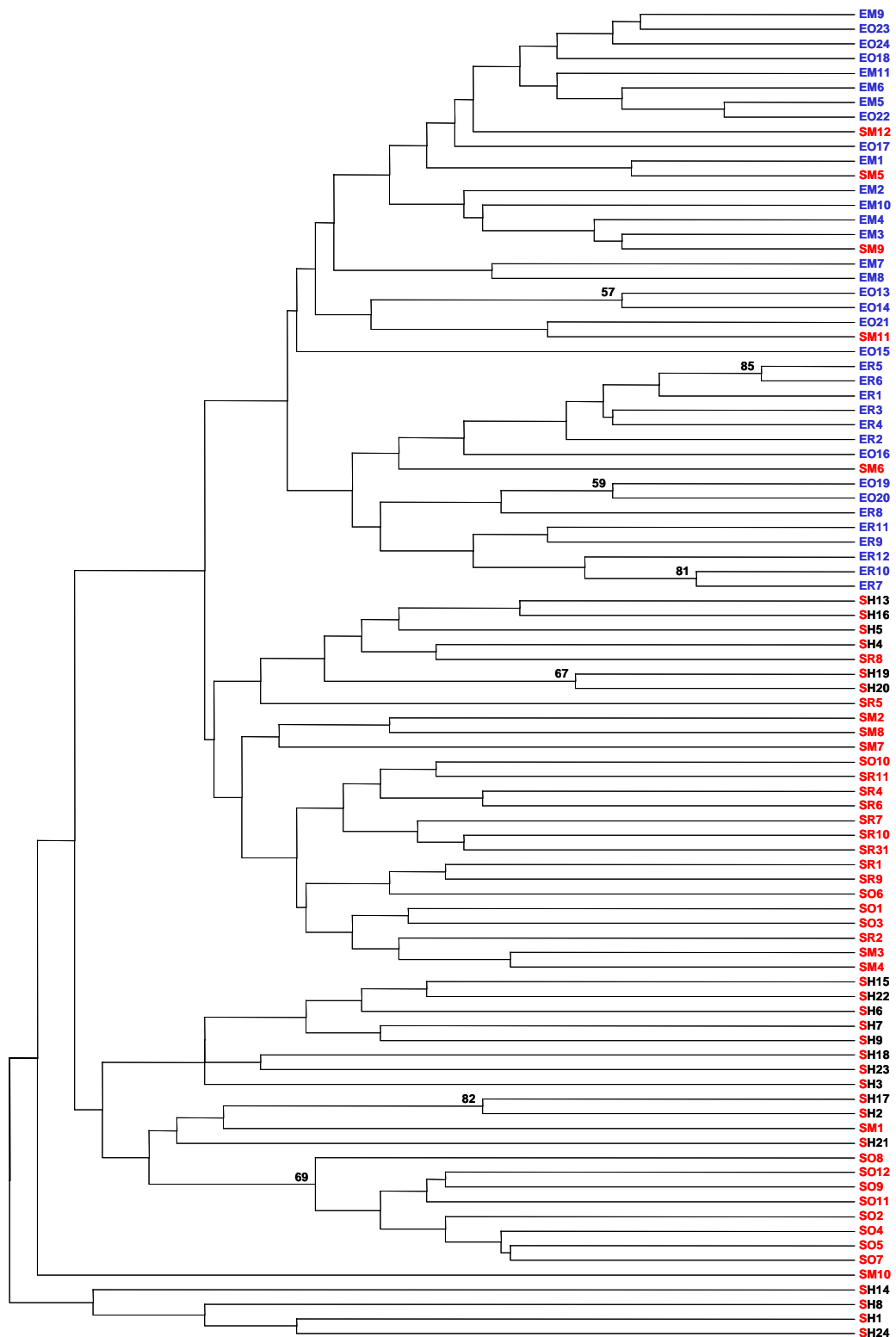

Fig. 2.3 RAPD genetic distances between subtidal and intertidal *Scoloplos armiger* from four different locations. Unrooted tree generated by the cluster analysis of UPGMA using Nei-Li distances. Bootstrap values >50 are indicated at the nodes (**E**= intertidal habitat; **S**= subtidal habitat; **O**, **M**, **R**= Sylt locations: "Odde", "Morsum", "Rømmø"; **H**= Helgoland location; numbers indicate individuals)

F -statistics from AMOVA also revealed significant difference between subtidal and intertidal habitat and no differentiation between localities (Table 2.4). 81% of the variance was attributable to individual variation ($p < 0.0001$), 22% was attributable to habitats ($\Phi_{\text{between habitats}} = 0.21225$, $p < 0.0001$), and no variance was due to geographic site, i.e. locality ($\Phi_{\text{between sites}} = -0.03068$). The negative variance between sites (Table 4) can be taken as zero (Weir 1996). Analysis with the software TFGA confirmed these results with the same partitioning of variance: $\Phi_{\text{between habitats}} = 0.1961$ (CI 0.2395-0.1560) and $\Phi_{\text{between sites}} = 0.0166$ (CI 0.0288-0.0624).

Table 2.4 Analysis of molecular variance (AMOVA) for population structure in six sites around Sylt grouped first according to locations ("Odde", "Morsum", "Rømø") and second according to habitat (subtidal, intertidal)

Source of variation	df	Sum of squares	Variance components	Percentage of variation	P-value	Fixation indices	Interpretation
between locations	2	52.878	-0.30591	-3.07	0.52297	$F_{ct} = -0.03068$	No differentiation between locations
between habitats	3	100.552	2.18160	21.88	<0.00001	$F_{sc} = 0.21225$	Significant difference between habitats subtidal / intertidal
within all sites	64	518.212	8.09706	81.19	<0.00001	$F_{st} = 0.18808$	

Genetic diversity within habitats

Shannon's index of diversity reflected higher genetic diversity within subtidal sites than within intertidal ones (Table 2.5; t-test of H'_j values of Sylt sites for all four primers, $p < 0,05$). Nei-Li genetic distances confirmed these result (AMOVA of mean distances for individual *S. armiger*, $p < 0,01$).

Table 2.5 Shannon's index (H'_j) as estimates of genetic diversity within sites, modified after Bussell (1999)

Primer	Intertidal <i>S. armiger</i>			Subtidal <i>S. armiger</i>				Average H'_j per primer across sites or H'_{pop}
	EM	EO	ER	SH	SM	SO	SR	
OPA 2	1.460	1.603	0.669	1.840	1.758	2.032	1.823	1.598
OPA 3	0.292	0.335	0.694	1.312	0.825	0.816	0.814	0.727
OPA 9	0.850	1.314	0.809	1.216	0.921	1.201	0.818	1.018
OPA 10	1.742	1.554	1.143	3.030	2.387	2.595	2.154	2.086
Multilocus H' per site	3.232	3.480	2.696	2.739	2.772	2.419	2.638	2.854
Sum H'_j	4.344	4.806	3.315	7.397	5.890	6.644	5.608	5.610

Genetic diversity among sites, reflected in Nei-Li genetic distances as well, were also higher in the subtidal: overall mean distance within the subtidal was 78.1% (SD 13.1) and within the intertidal was 57.2% (SD 10.8) (Table 2.6); AMOVA of mean distances within sites for individual *S. armiger*, $p < 0.01$.

Table 2.6 Genetic distances after Nei and Li (1979) between sites in percent; mean values and standard deviation (*parentheses*)

	EM	EO	ER	SM	SO	SR
EO	53.7 (13.2)					
ER	58.1 (8.3)	59.7 (9.6)				
SM	67.8 (17.0)	69.8 (14.7)	67.8 (17.0)			
SO	84.2 (10.4)	81.9 (10.6)	84.2 (10.4)	80.8 (12.4)		
SR	69.6 (10.0)	72.1 (8.3)	65.6 (8.1)	70.4 (10.8)	72.9 (12.7)	
SH	81.6 (11.8)	84.6 (11.9)	79.4 (12.8)	82.3 (10.6)	83.5 (9.9)	76.9 (12.3)

between intertidals
between inter- & subtidals
between subtidals

Analysis of AFLP

UPGMA clustering of AFLP haplotypes resulted in the same grouping according to subtidal and intertidal habitats as the RAPDs. The tree achieved by primer Ned-CAT is shown in Fig. 2.4. The independent primer combination MSE-CAC and Joe-AGG run with subsamples yielded the same pattern. Different from the RAPD tree there was a notable separated cluster of subtidal individuals from the locality "Odde".

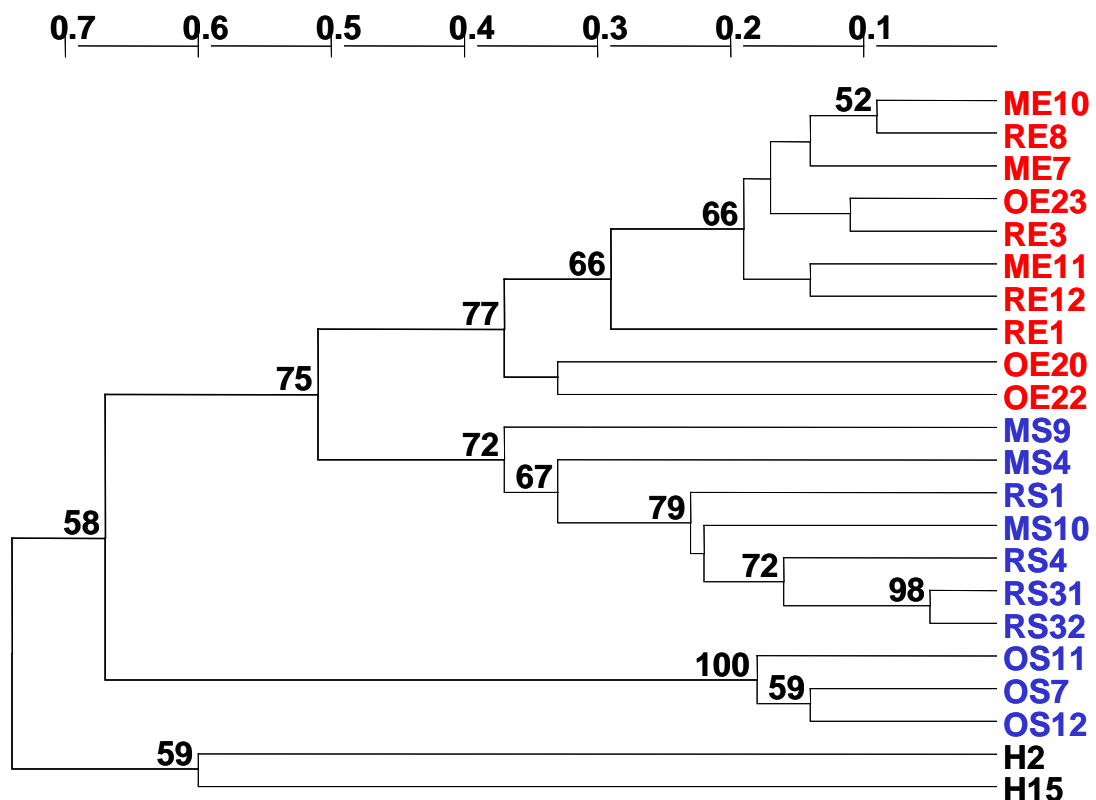

Fig. 2.4 AFLP genetic distances between subtidal and intertidal *Scoloplos armiger* from four different locations. Unrooted tree generated by the cluster analysis of UPGMA using Nei-Li distances. Primer Ned-CAT, 10 intertidal and 11 subtidal *S. armiger*. Bootstrap values >50 are indicated at the nodes. (E= intertidal habitat; S= subtidal habitat; O, M, R= Sylt locations: "Odde", "Morsum", "Rømø"; H= Helgoland location; numbers indicate individuals; SR3.1 and SR3.2 are replicates)

Discussion and conclusions

Our data support a genetic divergence of subtidal and intertidal *S. armiger*. We also confirm our initial assumption that pelagic larvae of *S. armiger* originate from the subtidal habitat. Intertidal specimens produced egg cocoons only. Thus in the Wadden Sea area around Sylt, both holobenthic and pelago-benthic development exist in close neighbourhood to each other. This is the first evidence for a spatially separate origin of two co-occurring larval types in this polychaete.

In our laboratory experiment we found no intermediate developmental mode which would support poecilogony (Hoagland and Robertson 1988). *S. armiger* individuals either were shedding their eggs into the water column, or alternatively, they were packing them into a jelly mass, the egg cocoon, from which juveniles migrate into the sediment. Intermediate types of development were found in *Streblospio benedicti* and *Boccardia proboscidea*, the only proven true poecilogonous polychaetes to be found in the literature. *S. benedicti* exhibited mixed reproductive traits in reciprocal crossings between planktotrophic and lecithotrophic form and in *B. proboscidea* developmental mode varied within one single brood of one female. Thus, interfertility between different developmental modes in both species (Levin et al. 1991; Gibson et al. 1999) and also molecular data provided support for conspecificity (Gibson et al. 1999; Schulze et al. 2000).

Genetic differences between habitats *versus* differentiation-by-distance

The existence of two distinct and spatially separated reproductive modes in *S. armiger* can be explained by two different scenarios. (1) The developmental mode is a plastic response to different environmental cues correlated with the division between intertidal and subtidal habitat. Under either conditions, individuals change their egg spawning behaviour. Individuals may migrate or drift between these habitats and together form genetically coherent local or regional populations. (2) The different modes of reproduction are genetically fixed. Individuals perform few or no migrations and rarely interbreed between habitats. Pelagic larvae of subtidal origin either find their way back to this habitat or post-settlement mortality in the intertidal is strong. Juveniles hatched from cocoons in the intertidal are rarely entrained in a bedload transport towards the subtidal or their mortality is high once translocated from the intertidal. Due to partial or

total reproductive isolation between *S. armiger* of intertidal and subtidal habitat genetically distinct populations or even species are present.

The two scenarios have different predictions as on the spatial patterns of genetic variability. While we predict only genetic differentiation through geographic separation (isolation by distance) in the first scenario (Wright 1946), a large genetic divergence between intertidal and subtidal sites irrespective of geographic distance must be present if the second scenario is applied. Clearly, our data support the second scenario for Wadden Sea populations of *S. armiger*. AMOVA analysis of RAPD haplotypes of Sylt specimens attributed a significant proportion of genetic variance to habitat and none to locality, i.e. geographic origin. This pattern is confirmed by our AFLP data. In UPGMA trees from both AFLP and RAPD data using Nei-Li distances, subtidal and intertidal individuals each were found in the same phylogenetic clade, while individuals of the same locality revealed no phylogenetic proximity. In the phylogenetic analysis bootstrap values are relatively low but the pattern is clear and there is high consistency among methods (i.e. AFLP, RAPD). RAPD haplotypes of Helgoland subtidal *S. armiger*, sampled 95 km distant from the Wadden Sea area around Sylt clustered closely with subtidal Sylt specimens. They were closer to subtidal Sylt specimens than the latter with their intertidal neighbours. Hence, even over these distances, geographic effects appear negligible compared to habitat type. However, in the AFLP tree Helgoland samples did not group within subtidals from Sylt but this may be due to both, few numbers of samples examined and higher sensitivity of the AFLP than the RAPD method.

As the only exception to the overall pattern we found five individuals of the subtidal site "Morsum" grouping within intertidals. Possibly these were in fact intertidal specimen which had migrated into the subtidal. Since the subtidal site "Morsum" is surrounded by large areas of intertidal habitat (Fig. 2.1), it is likely that this site can be most affected by immigration of intertidal *S. armiger*. The laboratory experiment on the origin of larvae also indicated unidirectional migration from the intertidal to the subtidal habitat. We observed two females collected in the subtidal forming egg cocoons. *S. armiger* is described as a mobile and vagile species (Holte 1998). Moreover, intertidal *S. armiger* were found to be highly erodible (Armonies 1999), lending additional support for the notion that the subtidal population occasionally receives migrants from the intertidal.

RAPD and AFLP have been found to be reliable methods in systematics (Harris 1999). Reproducibility between labs was doubted by some authors (Jones et al. 1997). In this study we found high reproducibility. Moreover, the hypothesis was studied in the same laboratory (for each method AFLP or RAPD) during one distinct period of time. We further note that any lack of reproducibility is conservative with respect to the hypothesis being tested. Moreover, AFLP and RAPD methods show essentially the same results. AFLP is considered as a highly reproducible method (Jones et al. 1997). We conclude that genetic divergence of subtidal and intertidal *S. armiger* indicates a fixed hereditary basis for distinct developmental modes. Whether there are even two species in *S. armiger* is an open question. Further experiments such as cross-breeding trials are necessary for a conclusive answer.

Genetic variability within habitats and dispersal potential

No matter if populations of poecilogonous species or different species are compared, genetic structure of marine invertebrates may be strongly influenced by the mode of larval development and its dispersal potential (Crisp 1978). The latter may be directly correlated with the effective population size, which again is the determinant for the numbers of alleles or bands kept in a population. Populations with larger effective population size tend to have higher heterozygosity (Kijima and Fujio 1984), which corresponds to within-population diversity. It can be expected that planktonically dispersed species exhibit low levels of genetic variation among local populations, but relatively high genotypic diversity within populations. In contrast, direct or holobenthic developers should undergo highly restricted dispersal and thus form sets of closed and relatively inbred local populations with low diversity and high levels of genetic variation among local populations (Burton and Feldman 1982). We found significantly higher genetic diversity within subtidal than within intertidal sites and also numerous bands which were unique only for subtidal *S. armiger*, whereas we found none for the intertidals. This is consistent with a higher effective population size in subtidal populations. Retention time in the water column for pelagic larvae of *S. armiger* is estimated to be two weeks (Plate and Husemann 1991). This time span theoretically allows the Sylt subtidal population to perform genetic exchange even with the open North Sea whereas intertidal *S. armiger* are limited to the near-shore area. In the intertidal the effective population size is supposed to be smaller, thus many more bands may be lost over time due to drift.

On the contrary, among-population distances were inconsistent with this model. They were higher between subtidal localities than between intertidal ones. Providing causes to this point must remain speculative. Comparing two neighbouring prosobranch gastropod species occurring in different environments, Hoskin (1997) found in one species four times higher genetic differentiation among populations though both species exhibit the same mode of development. The author suggests selective differences between estuarine and open-coast environments as one partial explanation. Conferred to *S. armiger*, subtidal habitat should then be more heterogenic in selective pressure than the intertidal one. However, mobility may be another factor diminishing among-population differences. Wilhelmsen (1999) found in *Littorina saxatilis* a remarkable low genetic differentiation within the Wadden Sea around Sylt. She suggests a high colonization potential in spite of the ovoviviparous development in this snail. Also *S. armiger* of the intertidal area of the Wadden Sea may be interconnected to a much higher extent by along-shore dispersal than *a priori* assumed. Erosion and migration via mobile sediments is a common means of transport for marine invertebrates in intertidal soft sediment communities (Tamaki 1987; Butman and Grassle 1992; Zühlke and Reise 1994; Turner et al. 1997; Grant et al. 1997). Armonies (1999) notes that benthic juveniles of *S. armiger* are exceptionally susceptible to sediment disturbance and displacement within the intertidal.

Population genetic structure of four *Littorina* species does not reflect predictions as to their dispersal potential. Instead, the significance of their historical demography is emphasized (Kyle and Boulding 2000). A system very similar to *S. armiger* is found in the polychaete *Hediste japonica*. One sibling species exhibits planktonic development while the other has direct developing larvae. Genetic marker data revealed that among-population differentiation is consistent with dispersal capacity (higher in the direct developing form) whereas within populational diversity was unexpectedly lower within the open-water planktonic form (Sato 1999). In *S. armiger* we find a similar partial discordance between population genetic prediction and empirical data, yet the situation is reversed, with concordance based on diversity while differentiation is at odds with expectations. Obviously, genetic patterns cannot be interpreted based on developmental mode alone but species- and habitat-specific dispersal characteristics need to be considered.

Developmental switch and reproductive isolation

Transitions in larval developmental strategies may lead to rapid reproductive isolation which finally may result in speciation (Hoagland and Robertson 1988). This is supported by numerous discoveries of sibling species which previously had been regarded as poecilogonous. In particular in polychaetes, several studies applying genetic markers were published on this subject. *Capitella* spp. (Grassle and Grassle 1976; Baoling et al. 1988), *Marenzelleria viridis* and *M. wireni* (Bastrop et al. 1998; Jürss et al. 1999) *Streblospio benedicti* and *S. gynobranchiata* (Schulze et al. 2000) and *Hediste japonica* spp. (Sato and Masuda 1997; Sato 1999). *Scoloplos armiger* is a potential candidate to be added to this list in the future. On the contrary the only true and undoubted examples of poecilogonous polychaetes in the literature are *Streblospio benedicti*, *Boccardia proboscidea* and *Pygospio elegans* (Morgan et al. 1999).

However, reproductive strategies may be derived from both, the phyletic history of the group and environmental cues. For *S. armiger* phyletic causation for one reproductive mode appears to be weak, since variability within the family Orbiniidae is high. Four of ten species exhibit direct development and six are free spawning (Giangrande 1997). Instead, physical differences between intertidal and subtidal environment must have disrupted modes of development. The egg cocoon has been considered to retain the larvae in the intertidal habitat (Gibbs 1968). Thus, the intertidal seems to feature suitable conditions for *S. armiger*, which are absent in the subtidal.

Mode of development may either be a consequence of genetic divergence or may first arise from habitat-population interaction and then cause genetic divergence. In the latter case evolution of reproductive isolation may be pushed by modification of the populations dispersal potential. As another possibility, developmental mode may be connected with mechanisms generating reproductive isolation such as spawning time, mate recognition, environmental tolerance and gamete incompatibility.

In recent years speciation in the marine habitat has attracted much attention (Palumbi 1992; Palumbi 1994). According to a strictly allopatric speciation model high dispersal and large populations typical for marine macroinvertebrate species suggest a lower speciation rate than is actually indicated by high marine biodiversity at all spatial or temporal scales. Given numerous marine sister species which occur in sympatry it has

been argued that reproductive isolation may evolve much faster than expected. Such divergence also applies to large, semi-isolated populations, driven by both well-known evolutionary mechanisms and newly discovered genetic processes. Polychaete species provide an excellent taxonomic group to study the evolution of population divergence in marine organisms, given their high plasticity in developmental modes with probable independent evolution (Giangrande 1997). They also exhibit broad geographic ranges and apparently no geographic limits to gene flow. Many sibling species occur in sympatry or parapatry while allopatric divergence is seldom apparent like in *Streblospio* spp. (Schulze et al. 2000). As shown in these species mitochondrial DNA can be used to age a species split and to interpret intraspecific variation in larval development within a phylogeographic framework. A similar approach will also be useful in *Scoloplos armiger*.

References

- Anderson DT (1959) The embryology of the polychaete *Scoloplos armiger*. Q J Microsc Sci 100:69-166
- Armonies W (1999) Drifting benthos and long-term research: why community monitoring must cover a wide spatial scale. Senckenb Marit (Suppl) 29:13-18
- Baoling W, Peiyuan Q, Songling Z (1988) Morphology, reproduction, ecology and isozyme electrophoresis of *Capitella* complex in Quindao. Acta Oceanol Sin 7:442-458
- Bastrop R, Jueress K, Sturmbauer C (1998) Cryptic species in a marine polychaete and their independent introduction from North America to Europe. Mol Biol Evol 15:97-103
- Bosselmann A (1991) Recruitment and postlarval growth of some macrozoobenthos species in the German Bight. Meeresforsch 33:141-158
- Bouchet P (1989) A review of poecilogony in gastropods. J Molluscan Stud 55:67-78
- Burton RS, Feldman MW (1982) Population genetics of coastal and estuarine invertebrates: does larval behaviour influence population structure? In: Kennedy VS (ed) Estuarine Comparisons. Academic Press, New York, pp 537-551
- Bussell JD (1999) The distribution of random amplified polymorphic DNA (RAPD) diversity amongst populations of *Isotoma petraea* (Lobeliaceae). Mol Ecol 8:775-789
- Butman CA, Grassle JP (1992) Active habitat selection by *Capitella* sp. I larvae. I. Two-choice experiments in still water and flume flows. J Mar Res 50:669-715
- Chalmers KJ, Waugh R, Sprent JI, Simons AJ, Powell W (1992) Detection of genetic variation between and within populations of *Gliricidia sepium* and *G. maculata* using RAPD markers. Heredity 69:465-472

- Crisp DJ (1978) Genetic consequences of different reproductive strategies in marine invertebrates. In: Battaglia B, Beardmore JA (eds) Marine organisms: genetics, ecology, and evolution. Plenum Press, New York, pp 257-273
- Engelen AH, Olsen JL, Breeman AM, Stam WT (2001) Genetic differentiation in *Sargassum polyceratum* (Fucales: Phaeophyceae) around the island of Curaçao (Netherlands Antilles). *Mar Biol* 139:267-277
- Excoffier L, Smouse PE, Quattro JM (1992) Analysis of molecular variance inferred from metric distances among DNA haplotypes: application to human mitochondrial DNA restriction data. *Genetics* 131:479-491
- Gätje C, Reise K (1998) Ökosystem Wattenmeer, Austausch-, Transport- und Stoffumwandlungsprozesse. Springer, Berlin
- Giangrande A (1997) Polychaete reproductive patterns, life cycles and life histories: an overview. *Oceanogr Mar Biol Annu Rev* 35:323-386
- Giard AC (1905) La poecilogonie. 6th International Congress of Zoology. pp 617-646
- Gibbs PE (1968) Observations on the population of *Scoloplos armiger* at Whitstable. *J mar biol Ass UK* 48:225-254
- Gibson G, Paterson I, Taylor H, Woolridge B (1999) Molecular and morphological evidence of a single species, *Boccardia proboscidea* (Polychaeta: Spionidae), with multiple development modes. *Mar Biol* 134:743-751
- Giere O (1968) Die Fluktuationen des marinen Zooplanktons im Elbe-Aestuar. *Arch Hydrobiol (Suppl)* 3/4:379-546
- Gillandt L (1979) On the ecology of polychaetes of the Helgoland rocky intertidal. *Helgol. Wiss. Meeresunters.* 32:1-35
- Grant J, Turner SJ, Legendre P, Hume TM, Bell RG (1997) Patterns of sediment reworking and transport over small spatial scales on an intertidal sandflat, Manujau Harbour, New Zealand. *J Exp Mar Biol Ecol* 216:33-50
- Grassle JP, Grassle JF (1976) Sibling species in the marine pollution indicator *Capitella* (Polychaeta). *Science* 192:567-569
- Harris S (1999) RAPD in systematics - a useful methodology? In: Hollingworth P, Bateman R, Gornall RJ (eds) *Molecular Systematics, Plant and Evolution*. Taylor and Francis, London, pp 221-228
- Hartmann-Schröder G (1996) *Polychaeta*. G. Fischer, Stuttgart
- Hoagland KE, Robertson R (1988) An assessment of poecilogony in marine invertebrates: phenomenon or fantasy? *Biol Bull (Woods Hole)* 174:109-125
- Holte B (1998) The macrofauna and main functional interactions in the sill basin sediments of the Pristine Hølandsfjord, Northern Norway, with autecological reviews for some key-species. *Sarsia* 83:45-54

- Hoskin MG (1997) Effects of contrasting modes of larval development on the genetic structures of populations of three species of prosobranch gastropods. *Mar Biol* 127:647-656
- Jägersten G (1972) Evolution of the Metazoan life cycle. Academic Press, London
- Janke K (1986) Die Makrofauna und ihre Verteilung im Nordost-Felswatt von Helgoland. *Helgol Meeresunters* 40:1-55
- Jones C, Edwards K, Castaglione S, Winfield M, Sala F, van deWiel C, Bredemeijer G, Vosman D, Matthes M, Daly A, Brettschneider R, Bettini P, Buiatti M, Maestri E, Malcevshi A, Marmioli N, Aert R, Volchaert G, Rueda J, Linacero R, Vazquez A, Karp A (1997) Reproducibility testing of RAPD, AFLP and SR markers in plants by a network of European laboratories. *Molecular Breeding* 3:381-390
- Jürss K, Röhner M, Bastrop R (1999) Enzyme activities and allozyme polymorphism in two genetic types (or sibling species) of the genus *Marenzelleria* (Polychaeta: Spionidae) in Europe. *Mar Biol* 135:489-496
- Kijima A, Fujio Y (1984) Relationship between average heterozygosity and river population size in chum salmon. *Bull Jap Soc scient Fish* 50:603-608
- Kyle CJ, Boulding EG (2000) Comparative population genetic structure of marine gastropods (*Littorina* spp.) with and without pelagic larval dispersal. *Mar Biol* 137:835-845
- Lambooy WF (1994) Computing genetic similarity coefficients from RAPD data: the effects of PCR artifacts. *Genome Res* 4:31-37
- Levin LA, Zhu J, Creed E (1991) The genetic basis of life-history characters in a polychaete exhibiting planktotrophy and lecithotrophy. *Evolution* 45:380-397
- Miller MP (1997) Tools for population genetic analysis (TFPGA) 1.3: A Windows program for the analysis of allozyme and molecular population genetic data. Computer software distributed by the author.
- Morgan TS, Rogers AD, Paterson GLJ, Hawkins LE, and Shearer M (1999) Evidence for poecilogony in *Pygospio elegans* (Polychaeta: Spionidae). *Mar Ecol Prog Ser* 178:121-132
- Nei M, Li W-H (1979) Mathematical model for studying genetic variation in terms of restriction endonucleases. *Proc Natl Acad Sci USA* 76:5269-5273
- Palumbi SR (1992) Marine speciation on a small planet. *Trends Ecol Evol* 7:114-118
- Palumbi SR (1994) Genetic divergence, reproductive isolation, and marine speciation. *Ann Rev Ecol Syst* 25:547-572
- Plate S, Husemann E (1991) An alternative mode of larval development in *Scoloplos armiger* (O. F. Müller, 1776) (Polychaeta, Orbiniidae). *Helgol Meeresunters* 45:487-492

- Sato M (1999) Divergence of reproductive and developmental characteristics in *Hediste* (Polychaeta: Nereididae). *Hydrobiologia* 402:129-143
- Sato M, Masuda Y (1997) Genetic differentiation in two sibling species of the brackish-water polychaete *Hediste japonica* complex (Nereididae). *Mar Biol* 130:163-170
- Schneider, S, Roessli, D, Excoffier, J (2000) Arlequin, version 2.000: a software for population genetics data. Genetics and Biometry Laboratory, University of Geneva, Geneva
- Schulze SR, Rice SA, Simon JL, Karl SA (2000) Evolution of poecilogony and the biogeography of North American populations of the Polychaete *Streblospio*. *Evolution* 54:1247-59
- Sneath PHA, Sokal RR (1973) Numerical taxonomy. Freeman and Company, San Francisco
- Sveshnikov VA (1960) Pelagic larvae of some polychaeta in the White Sea. *Zool Zh* 39:343-355
- Tamaki A (1987) Comparison of resistivity to transport by wave action in several polychaete species on an intertidal sand flat. *Mar Ecol Prog Ser* 37:181-189
- Turner SJ, Grant J, Pridmore RD, Hewitt JE, Wilkinson MR, Hume TM, Morrisey DJ (1997) Bedload and water-column transport and colonization processes by post-settlement benthic macrofauna: Does infaunal density matter? *J Exp Mar Biol Ecol* 216:51-75
- Van de Peer Y, De Wachter R (1994) TREECON for Windows: a software package for the construction and drawing of evolutionary trees for the Microsoft Windows environment. *Comput Appl Biosci* 10:569-570
- Vos P, Hogers R, Bleeker M, Reijans M, Van De Leet T, Hornes M, Frijters A, Pot J, Peleman J, Kuiper M, Zabeau M (1995) AFLP: a new technique for DNA fingerprinting. *Nucleic Acids Res* 23:4407-4414
- Weir BS, Cockerham CC (1984) Estimating F -statistics for the analysis of population structure. *Evolution* 38:1358-1370
- Weir B (1996) Intraspecific differentiation. In: Hillis D, Moritz C, Marble B (eds) *Molecular systematics*. Sinauer Associates, Sunderland, Massachusetts, pp 385-406
- Wilhelmsen U (1999) Rapid colonization of new habitats in the Wadden Sea by the ovoviparous *Littorina saxatilis* (Olivi). *Helgol Meeresunters* 52:325-335
- Williams JGK, Kublelik AR, Livak KJ, Rafalski JA, Tingey SV (1990) DNA polymorphism amplified by arbitrary primers are useful as genetic markers. *Nucleic Acids Res* 18:6531-6335
- Wolfe AD, Liston A (1998) Contributions of the polymerase chain reaction to plant systematics and evolutionary biology. In: Soltis DE, Soltis PS, Doyle JJ (eds) *Molecular Systematics of Plants II*. Kluwer, pp 43-86

Wright S (1946) Isolation by distance under diverse systems of mating. *Genetics* 31:39-59

Zühlke R, Reise K (1994) Response of macrofauna to drifting tidal sediments. *Helgol Meeresunters* 48:277-28

Chapter 3

Reproductive isolation between intertidal and subtidal *Scoloplos armiger* (Polychaeta, Orbiniidae) indicates sibling species in the North Sea

Inken Kruse, Karsten Reise

Abstract

Two distinct modes of development in the common polychaete *Scoloplos armiger* (O. F. Müller, 1776) occur in the North Sea region: holobenthic development in egg cocoons and pelagic larvae hatching from suspended eggs. In the northern Wadden Sea near the island of Sylt we observed that egg cocoons are produced intertidally while pelagic larvae originate from the adjacent subtidal zone. A previous genetic comparison between these subtidal and intertidal populations revealed distinct gene pools suggesting that reproductive differences are not phenotypic but heritable. In this study, cross breeding experiments show that intertidal and subtidal populations are reproductively isolated. Couples with males and females from different habitats had no offspring. Production of egg cocoons is determined by female origin from the intertidal zone. Pelagic larvae occurred only in couples with subtidal females and subtidal males. Intertidal males have spermatozoa with heads twice as long and a significantly shorter flagellum than those from subtidal males. We suspect that deviating sperm morphology may cause the reproductive breakdown at the fertilization stage. Juveniles hatching from cocoons have shorter anal cirri compared to juveniles which metamorphosed from pelagic larvae. We conclude there to be two sympatric sibling species in *S. armiger*: 'Type I' living in the intertidal with egg cocoons, no pelagic larvae, elongated sperm heads, shortened sperm flagella and anal cirri, and a 'Type S' living subtidally lacking egg cocoons but with pelagic larvae, short sperm heads, long sperm flagella and anal cirri.

Introduction

In marine invertebrates, species are usually diagnosed by externally visible recognition marks using pictorial keys for identification. Problems with this arise when (a) individuals within a species vary considerably in phenotype triggered by environmental factors during development, (b) speciation is incomplete with some gene exchange occurring along a cline between semispecies, and (c) sibling species which are identical or very similar in their morphological traits yet have no viable hybrids in nature (Mayr 1963; Dobzhansky et al. 1977; Ridley 1996).

How common sibling species are in the marine environment is unknown. However, Knowlton (1993) states that widely distributed species are frequently being found to consist of distinguishable subspecies or siblings when examined in sufficient detail. Therefore the morphological comparison has been extended from the outer appearance to inner anatomy and ultrastructure, and from adult to juvenile or sperm characteristics. In some cases a combination of several characters achieved a good separation of different taxa (McDonald et al. 1991). Particularly powerful has been the direct measurement of genetic distance and divergence. Crucial for the biospecies concept (Mayr 1942; Dobzhansky et al. 1977), however, are field and experimental data on reproductive isolation. Isolation mechanisms may be prezygotic such as separation by habitat, season, mating behavior, and by gametes failing to attract each other or being unable to fuse. After zygote formation, hybrid sterility or inviability may cause a reproductive breakdown (postzygotic isolation).

The polychaete *Scoloplos armiger* (O. F. Müller, 1776) is purported to be a cosmopolitan species known from all zoogeographic regions (Hartmann-Schröder 1996, p. 598). It ranges from low salinities in the Baltic Sea to fully marine conditions, from the intertidal zone down to depths of 200 m in Norwegian fjords (Holte and Gulliksen 1998) and 2000 m off Greenland (Wesenberg-Lund 1950) or off Japan (Annenkova 1938), and from tropical sites (Frith et al. 1976) to polar regions (Sveshnikov 1960). However, Beesley et al. (2000) doubt that *S. armiger* found around Australia and elsewhere in the world all belong to the same species. In the eastern North Atlantic, two developmental types have been reported: holobenthic development in egg cocoons in the intertidal zone (Gibbs 1968 and references therein) and pelagic larvae in open water (Banse 1955; Sveshnikov 1960; Giere 1968; Plate and Husemann 1991; Bosselmann 1991). After comparing descriptions of both *S. armiger*

larval types from the Atlantic (Anderson 1959) and the White Sea (Sveshnikov 1960) with those of Orbiniidae from California, Blake (1980) suspects sibling species or misidentification in *S. armiger*. He notes that holobenthic larvae of *S. armiger* more closely resemble those of *Leitoscoloplos pugettensis* than pelagic *S. armiger* larvae, and that pelagic larvae of *S. armiger* are more similar to the larvae of *S. acmeceps* than to holobenthic *S. armiger* larvae.

Our own observations near the island of Sylt in the eastern North Sea revealed that holobenthic development in egg cocoons is confined to the intertidal, while the pelagic larvae originate from the adjacent subtidal, and that adjacent intertidal and subtidal gene pools have a higher genetic distance than gene pools from within these habitats over a wider area (Kruse et al. submitted). This suggests there may be two species of *Scoloplos* in the North Sea, separated by habitat and by their mode of development. If speciation had occurred sympatrically, there should have been natural selection to prevent gene exchange between intertidal and subtidal populations.

The aim of this study is to test for reproductive isolation in cross breeding experiments, coupling mates from adjacent intertidal and subtidal sediments, and to compare the results of couples from within and between the two habitats. The proof of reproductive isolation strong enough to interdict all or most gene exchange would provide further evidence for the existence of two sibling species under the name of *S. armiger*. A clarification of the species status is of some interest because *S. armiger* is not only widespread and one of the most dominant members of the macrofauna in soft-sediments of the eastern North Atlantic (e.g. Stripp 1969; Beukema 1976; Ziegelmeier 1978; Olenin and Schiedek 1996) but also this case would show that the lower tide line suffices as a divide for a speciation process.

Materials and methods

Study area

Scoloplos armiger was collected in the Sylt-Rømø Bight, a tidal basin in the North Sea. The bight is part of a continuous tidal area extending over 500 km of coastline, called the Wadden Sea. Tides are semidiurnal with a range of about 2 m. The Sylt-Rømø Bight covers about 400 km², of which 33% belong to the intertidal zone, 57% to the shallow subtidal (<5m depth) and 10% to deeper tidal channels (max. depth ~ 40m). Water exchange between the Sylt-Rømø Bight and the open North Sea takes place

through a 2.8 km-wide tidal channel. More information about the area is given in Gätje and Reise (1998).

Scoloplos armiger was collected at intertidal and subtidal sites at location "Odde" (see Fig. 1 in Kruse et al. submitted) and were collected for crossbreeding experiments and for comparison of spermatozoa (subtidal position at 55° 01,47 N; 08° 27,98 E; intertidal position at 55° 01,09 N; 08° 26,00 E).

Crossbreedings

To investigate the interbreeding capability of intertidal and subtidal *S. armiger* one male and one female from the same or different habitat (subtidal and intertidal) were placed together in aquaria (21,5 cm x 10,5 cm x 23 cm). Reciprocal crosses between habitats and crosses within habitats were replicated seven times. Additionally, seven intertidal females were cultured in isolation. Worms were collected in the field prior to the spawning season in February, when gonads are ripe and males and females are easily distinguishable. Subtidal specimens were sampled from a research vessel at 5 m water depth and 2 km apart from where intertidal specimens were collected. These sampling sites at location "Odde" refer to earlier studies on *S. armiger* applying genetic methods (Kruse et al. submitted). The experiment was set up on March 3, 2000. All 35 aquaria contained 4,5 cm of sediment from the subtidal habitat, which was sieved through 1 mm meshes and covered with 14 cm of sea water, filtered through 40 µm mesh. Aquaria were aerated and subject to artificial light in day-night rhythm (14 hours light, 10 hours dark). Temperature was first adjusted to the concurrent water temperature in the field (5 °C) and then gradually risen to 14 °C over a period of 7 days. Each day deposition of egg cocoons was controlled by eye. Occurrence of pelagic larvae and eggs was recorded by sampling the water column every third day. The latter was done using a tube to take a 3 l water sample from each aquarium and to filter it through a 80 µm mesh. Water was replaced by new 40 µm filtered sea water. Three weeks after no more spawning could be observed, the occurrence of benthic larvae was examined. The sediment surface of the aquaria was sampled by sucking up the upper few mm using a tube of 6 mm width. Juvenile worms were extracted by shaking this sediment with added sea water within a beaker, and decanting the supernatant water with suspended sediment through a 80 µm mesh. The sieve residue was examined for larvae using a dissecting microscope.

Sperm morphology

After abandonment of the crossing experiment on March 22, 2002, male *S. armiger* were used for comparison of spermatozoa from intertidal and subtidal specimens. Three males of each habitat were harvested with ripe gametes from the experiments. Additional males with ripe spermatozoa were collected in the field at the sites already sampled for the crossbreeding experiment. The intertidal was sampled on March 24, 2002, harvesting 10 unspawned worms, the subtidal was sampled on March 28, 2002, where 6 unspawned males were collected.

Spermatozoa of all males were gained by tapping the body wall of the worms. Morphology of spermatozoa was examined by immersion light microscope and by scanning electron microscope (SEM). For the latter spermatozoa were fixed with 2,5% glutaraldehyde in sea water and dehydrated with 30%, 50% and 70% ethanol in sea water. Using a vacuum pump they were put on membrane filters (Nucleopore), which were laid in an acidified dimethoxypropane (DMP) bath for 30 min (0.1 ml conc. HCL per 100 ml DMP) and then transferred to neutral DMP for two days until DMP has evaporated. Then filters were glued on aluminium stubs and sputtered with gold-palladium using a BAL-TEC SCD 50. Spermatozoa were examined and pictures were taken using the scanning electron microscope Zeiss DSM 940. At five sperms from males of each intertidal and subtidal habitat heads and flagella were measured from SEM photos.

Length of anal cirri

Juvenile *S. armiger* of early benthic stages raised in laboratory cultures were noted to differ in anal cirri length depending on mode of development, holobenthic or pelagic. A systematic comparison of anal cirri between intertidal and subtidal *S. armiger* was performed on field samples from both habitats taken on May 16, 1998 when strong easterly winds caused an extraordinary exposure of the subtidal habitat, allowing to walk on. The subtidal sample site (55° 01,09 N; 08° 26,06 E) was 700 m northeast of the intertidal one (55° 01,85 N; 08° 25,82 E) and 0,8 m below spring low tide level.

Anal cirri of 50 intertidal and 45 subtidal juvenile *S. armiger* were measured after anesthetization with magnesium chloride (8% in sea water) and placement of the worms on micro slides without squeezing under a microscope (magnification factor 200 to 400). *S. armiger* has two anal cirri of equal length. However, these are highly

fragile and caution was taken in handling the worms. Only specimens with both anal cirri of equal length were included in the analysis. Developmental stage of individuals was determined by counting setiger numbers of the juveniles to ensure that equal size groups of intertidal and subtidal habitat were compared. Worm size differences and length of anal cirri between intertidal and subtidal habitats were subjected to *t*-test using STATISTICA 5.1. Inhomogeneous variances were transformed by logarithm.

Results

Crossing experiment

Only couples where male and female came from the same habitat produced viable offspring (Fig. 3.1).

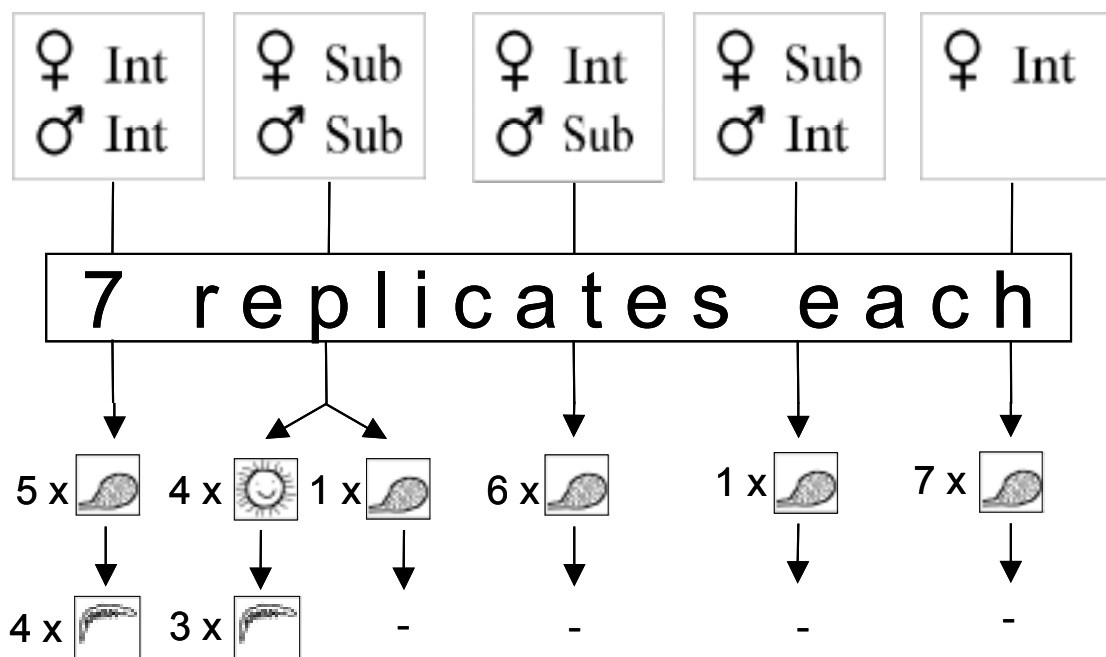
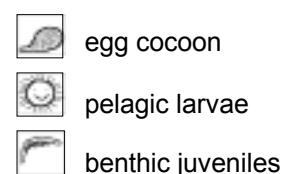

Fig. 3.1 Crossbreeding experiment with couples of one male and one female from different and the same habitat. INT: intertidal specimen, SUB: subtidal specimen. Each combination was replicated seven times. In the third and fourth row marked by arrows results are indicated by symbols (see at right), with the number of replicates showing reproductive output



Egg cocoons were produced by intertidal parents in five out of seven replicates, giving rise to benthic juveniles in four replicates. The eggs in the cocoons turned from orange to the brown colour of hatching juveniles. Pelagic larvae were recorded in four of seven replicates from subtidal parents, developing to benthic juveniles in three replicates. In mixed couples with specimens from different habitats no viable pelagic larvae could be raised. In crosses with intertidal females and subtidal males egg cocoons were produced in six replicates, but several days after being spawned, the eggs decayed. Under a dissecting microscope the eggs appeared paler and inflated compared to those from intertidal couples. The eggs turned from orange to pale pink, presumably indicating bacterial infection. The eggs produced by 7 single intertidal females suffered the same fate.

The females from the intertidal habitat produced egg cocoons only. Occurrence of egg cocoons was dependent on intertidal origin of the female. Two females from the subtidal site also spawned egg cocoons, where eggs decayed. In the experiment time span of spawning egg cocoons range from March 11 to March 29 and for eggs shed into the water from March 27 to April 4.

The experimental set-up was maintained. Several adults died, mainly those from the subtidal habitat. However, in March of the following year survivors had a second spawning. All spawning females maintained their egg spawning behaviour. Seventeen females of the intertidal which had spawned egg cocoons did so again and one surviving female which had spawned pelagic larvae did so again.

Spermatozoa

Intertidal and subtidal *S. armiger* show remarkable differences in spermatozoa morphology. Sperms of subtidal worms have significantly shorter heads (sperm head length $3.6 \mu\text{m} \pm 0.1$) than sperms of intertidal specimens ($8.2 \mu\text{m} \pm 0.3$) where sperm heads have elongated nuclei (Fig. 3.2) ($n=5$; t -test, $p<0.01$).

Additionally, sperm flagella of subtidal *S. armiger* were longer ($61.5 \mu\text{m} \pm 1.2$) than those of intertidal origin ($52.9 \mu\text{m} \pm 4.7$) ($n=5$; t -test, $p<0.01$). Sperm of all the examined males, 13 from the intertidal and 9 from the subtidal site, looked the same within each habitat.

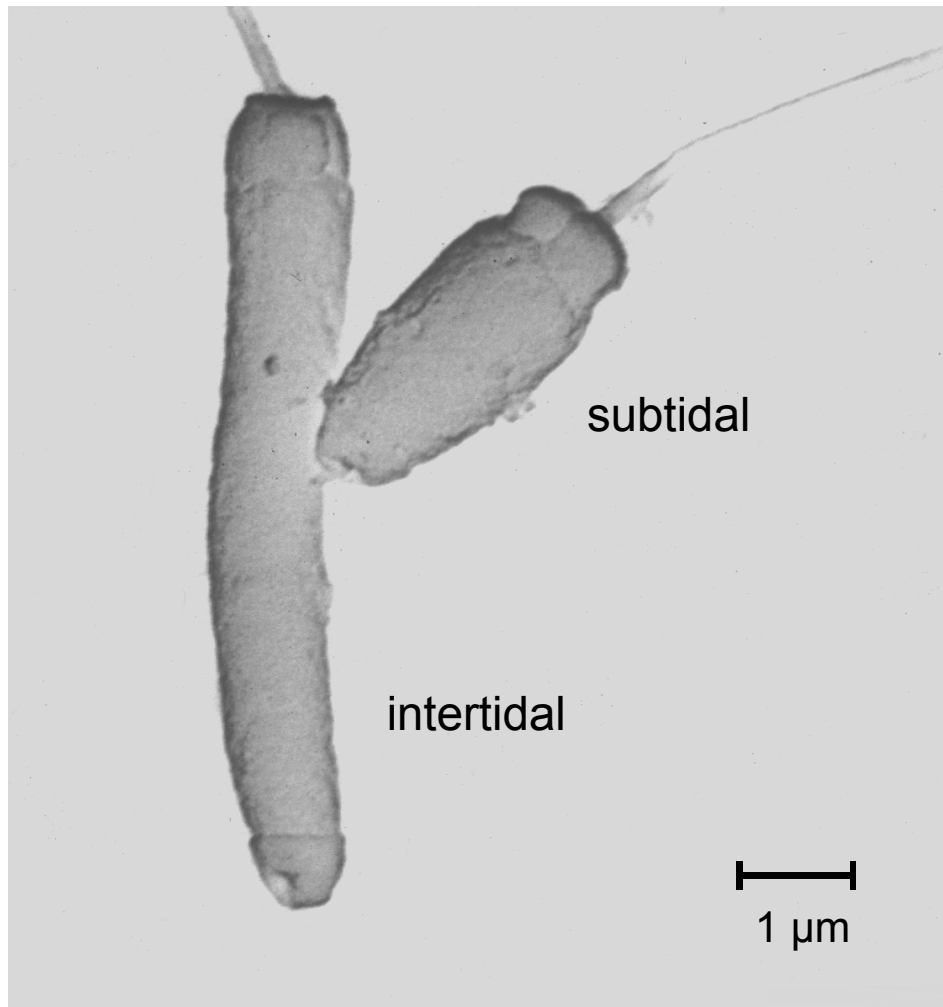

Fig. 3.2 Sperm heads of intertidal (left) and subtidal (right) male of *Scoloplos armiger*. Intertidal male with elongated nucleus more than twice as long as the subtidal one

Anal cirri length of subtidal and intertidal benthic juveniles

Subtidal benthic juveniles of *S. armiger* had significantly longer anal cirri ($25.2 \mu\text{m} \pm 10.8$) than juveniles from the intertidal habitat ($9.8 \mu\text{m} \pm 3.1$) (Fig. 3.3; Fig. 3.4 a,b) (*t*-test, $p < 0.05$). Compared juveniles had the same setiger number, there was no significant difference in between intertidal (24 ± 4 setigers) and subtidal *S. armiger* (25 ± 7 setigers) (*t*-test, $p > 0.1$).

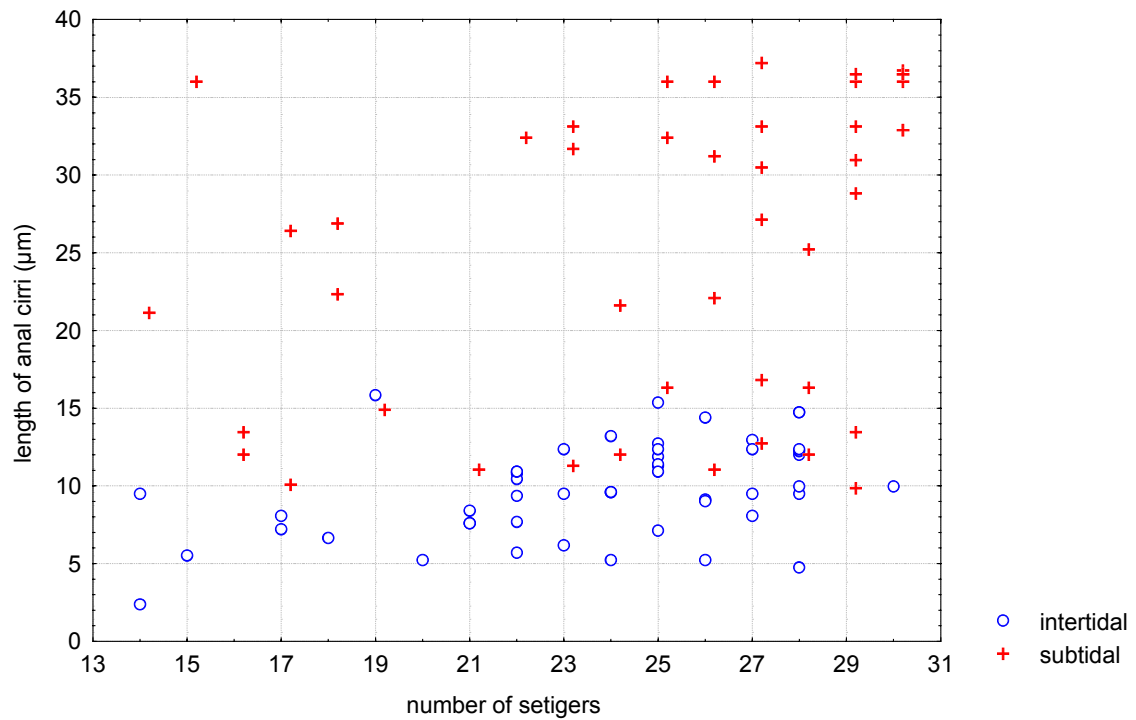

Fig. 3.3 Length of anal cirri plotted against the number of setigers of benthic juvenile *Scoloplos armiger* from intertidal (n= 50) and subtidal (n= 45) habitat

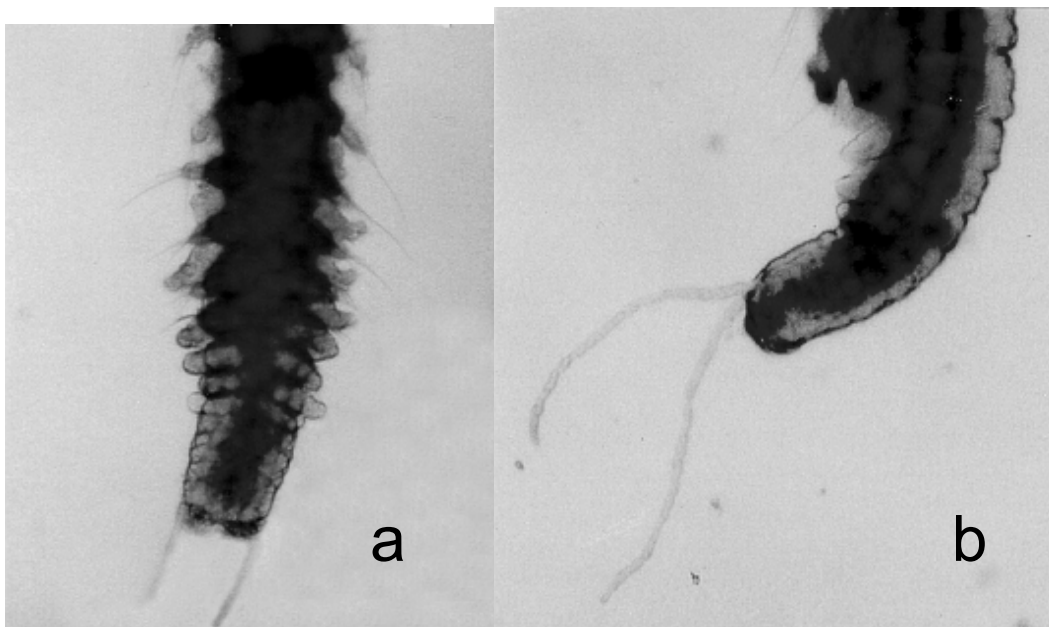

Fig. 3.4 Anal cirri at posterior ends of benthic juveniles of *S. armiger*, visible as filamentous appendages below. Both juveniles of 17 setiger stage. **a** – intertidal, **b** - subtidal specimen

Discussion

Proof of reproductive isolation

The cross breeding experiment between intertidal and subtidal *Scoloplos armiger* suggests complete reproductive isolation because between-habitat couples lacked offspring while within-habitat couples produced benthic juveniles and pelagic larvae, respectively. The experiment simulated subtidal conditions. Nevertheless, intertidal females produced egg cocoons. This rejects the possibility of a phenotypic switch in reproductive mode induced by tidal exposure.

On the other hand, two females of subtidal origin produced egg cocoons. We assume that our operational categories of intertidal and subtidal worms defined by their occurrence at two respective sites has its limits. Although egg cocoons anchored in the sediment and hatching of the juveniles through the vertical stalks directly into subsurface sediment may help to keep worms within the narrow tidal zone (Gibbs 1968; Reise 1979), resuspension and subsequent drift of benthic juveniles with tidal currents has been recorded during phases of strong wave action (Armonies 1994, 1998). With respect to the propagules of the subtidal *S. armiger*, no mechanism is known how pelagic larvae could avoid settlement in the intertidal zone. Thus we expect the lower tide line to be a permeable borderline allowing for some overlap in occurrence between intertidal and subtidal *S. armiger*. Consequently, there was no guarantee that all experimental worms belonged to the designated categories.

Intertidal females produced egg cocoons also when kept alone and in the presence of subtidal males. Apparently these eggs remained unfertilized. Thus, there is no indication of parthenogenesis, and ripe females simply have to get rid of the egg load. Worms surviving the spawning season spawned again in the next year and stuck to the original mode of reproduction. This corroborates respective inferences from field data (Gibbs 1968) that individuals may spawn in more than one season, and provide additional support that the mode of reproduction is inherited and not triggered by environmental conditions prevalent during gonad development.

How is reproductive isolation achieved?

Intertidal and adjacent subtidal *S. armiger* may often get into contact with each other, and there is no sign of a temporal mismatch in spawning time. A behavioral mismatch

may be likely. Weber (1992) observed intertidal males and females in the same burrow tube when egg cocoons are produced. Subtidal males and females may not associate that closely, releasing sperms and eggs into the water column. However, this aspect needs further study.

The striking difference in sperm morphology originating from intertidal and subtidal males, strongly suggests gametic isolation. Sperm morphology has been widely regarded as a valid means to separate sibling species from another (Franzén 1956; Rice and Simon 1980; Olive 1983; Pfannenstiel and Grünig 1990). Between nine *Capitella*, *Capitomastus* and *Capitellides* species, significant differences were found in nucleus lengths (Eckelbarger and Grassle 1987). Representing a case similar to *S. armiger*, all these species differ strikingly in reproductive modes while they are hard to distinguish morphologically. Variations in sperm dimensions were quite low within the species but overlap within the genera. According to Jamieson and Rouse (1989) elongation of the nucleus is a common evolutionary trend in polychaete sperm related to a close association of male and female during sperm transfer. Intertidal *S. armiger* support this model. Correspondingly, the short nucleus and long flagella in the sperm of subtidal *S. armiger* suggests fertilization in the water column. A similar correspondence between sperm morphology and mode of reproduction is known from the siblings *Platynereis dumerilii* with short headed spermatozoa and which releases gametes into the water and *P. massiliensis* with long headed spermatozoa and spawning within a brooding tube (Pfannenstiel et al. 1987).

Two sibling species in *S. armiger* in the North Sea

Based on habitat separation and distinct gene pools (Kruse et al. submitted), contrasting mode of reproduction, lack of viable hybrids in cross breeding experiments, differences in sperm shape and in anal cirri length of juveniles, while otherwise adult morphology reveals no differential characters, we suggest the existence of two sympatric sibling species termed *S. armiger* 'Type I' dwelling in the intertidal and 'Type S' in the adjacent subtidal zone of the North Sea.

The geographic ranges of these siblings still need to be investigated. Reports of egg cocoon occurrence of *S. armiger* in the literature are restricted mainly to the soft bottom intertidal of the North Sea region (e. g. Schultze 1855; De Groot 1907; Thamdrup 1935; Gibbs 1968), and adjacent waters (English Channel: Prenant in Cabioch et al. 1968; Irish Sea: Hornell 1891; Kattegat: Rasmussen 1973). The latter

being the transition zone between the North Sea and the Baltic Sea which lacks an extended intertidal zone. From the Baltic, Mau (1882) reports short sperm heads (3.9 μm) and Banse (1955) mentions pelagic larvae. From the Skagerrak, Franzén (1956) depicts *S. armiger* sperm with a short, spherical head. Presumably all these may belong to our 'Type S'. Outside the North Sea, pelagic larvae of *S. armiger* have been reported from the White Sea (Sveshnikov 1960). However, the many siblings in *Capitella* (Grassle and Grassle 1976) may serve as a warning against the assumption that all *S. armiger* without egg cocoons belong to a single species.

References

- Anderson DT (1959) The embryology of the polychaete *Scoloplos armiger*. Q J microsc Sci 100:69-166
- Annenkova NP (1938) Polikheti severnoi chasti iaponskogo moria i ikh fatsial'noe i vertikal'noe raspredelenie - Polychaeta of the North Japan Sea and their horizontal and vertical distribution. Gidrobiol eksped 1934 g. Iaponskoje More. Trudy 1:81-230
- Armonies W (1994) Drifting meio- and macrobenthic invertebrates on tidal flats in Königshafen: a review. Helgol Meeresunters 48:299-320
- Armonies W (1998) Driftendes Benthos im Wattenmeer: Spielball der Gezeitenströmungen? In: Gätje C, Reise K (eds) Ökosystem Wattenmeer: Austausch-, Transport- und Stoffumwandlungsprozesse. Springer, Berlin, pp 473-498
- Banse K (1955) Über das Verhalten von meroplanktischen Larven in geschichtetem Wasser. Kiel Meeresforsch 11:188-200
- Beesley PL, Ross GJB, Glasby CJ (2000) Polychaetes & Allies: The Southern Synthesis. Fauna of Australia. Vol. 4 A. Polychaeta, Myzostomida, Pogonophora, Echiura, Sipuncula. CSIRO Publishing, Melbourne
- Beukema JJ (1976) Biomass and species richness of the macro-benthic animals living on the tidal flats of the Dutch Wadden Sea. Neth J Sea Res 10:236-261
- Blake JA (1980) The larval development of Polychaeta from the northern California coast IV. *Leitoscoloplos pugettensis* and *Scoloplos acmeceps* (Familiy Orbiniidae). Ophelia 19:1-18
- Bosselmann A (1991) Recruitment and postlarval growth of some macrozoobenthos species in the German Bight. Meeresforsch 33:141-158
- Cabioch L, L'Hardy JP, Rullier F (1968) Inventaire de la Faune marine de Roscoff. Annélides. Trav Stat Biol Roscoff 17:1-95
- De Groot GJ (1907) Aanteekenigen over de ontwikkeling van *Scoloplos armiger*. Dissertation, University of Leiden

- Dobzhansky T, Ayala F, Stebbins GL, Valentine JW (1977) Evolution. Freeman, San Francisco
- Eckelbarger KJ, Grassle JP (1987) Spermatogenesis, sperm storage and comparative sperm morphology in nine species of *Capitella*, *Capitomastus* and *Capitellides* (Polychaeta: Capitellidae). Mar Biol 95:415-429
- Franzén Å (1956) On spermiogenesis, morphology of the spermatozoon, and biology of fertilization among invertebrates. Zool Bidr Från Uppsala 31:355-482
- Frith DW, Tantanasiwong R, Bhatia O (1976) Zonation of macrofauna on a mangrove shore, Phuket Island. Res Bull Phuket Mar Biol Cent 10:1-37
- Gätje C, Reise K (1998) Ökosystem Wattenmeer, Austausch-, Transport- und Stoffumwandlungsprozesse. Springer, Berlin
- Gibbs PE (1968) Observations on the population of *Scoloplos armiger* at Whitstable. J mar biol Ass UK 48:225-254
- Giere O (1968) Die Fluktuationen des marinen Zooplanktons im Elbe-Aestuar. Arch Hydrobiol (Suppl) 3/4:379-546
- Grassle JP, Grassle JF (1976) Sibling species in the marine pollution indicator *Capitella* (Polychaeta). Science 192:567-569
- Hartmann-Schröder G (1996) Polychaeta. G. Fischer, Stuttgart
- Holte B, Gulliksen B (1998) Common macrofauna dominant species in the sediments of some north Norwegian and Svalbard glacial fjords. Polar Biol 19:375-382
- Hornell J (1891) Report on the polychaetous annelids of the L.M.B.C. district. Trans Liverpool biol Soc 5:223-268
- Jamieson BGM, Rouse GW (1989) The spermatozoa of the Polychaeta (Annelida): an ultrastructural review. Biol Rev 64:93-157
- Knowlton N (1993) Sibling species in the sea. Annu Rev Ecol Syst 24:89-216
- Kruse I, Reusch TBH, Schneider MV (submitted) Sibling species or poecilogony in the polychaete *Scoloplos armiger*? Mar Biol
- Mau W (1882) Über *Scoloplos armiger* O. F. Müller. Zeit f wiss Zool Leipzig 36:389-432
- Mayr E (1942) Systematics and the origin of species. Columbia University Press, New York
- Mayr E (1963) Animal species and evolution. Harvard University Press, Cambridge
- McDonald JH, Seed R, Koehn RK (1991) Allozyme and morphometric characters of three species of *Mytilus* in the Northern and Southern hemispheres. Mar Biol 111:323-335

- Olenin S, Schiedek D (1996) Is the polychaete *Scoloplos armiger* a biological marker of saline water inflows into subhalocline areas of the Baltic proper? Baltic Marine Science Conference. Rønne, Bornholm. Abstracts, p. 3
- Olive PJ (1983) Annelida - Polychaeta. In: Adiyodi KG, Adiyodi RG (eds) Spermatogenesis and sperm function. John Wiley, Chichester
- Pfannenstiel, H-D and Grünig, C. (1990) Spermatogenesis and sperm ultrastructure in the polychaete genus *Ophryotrocha* (Dorvilleidae). Helgol Meeresunters 44:159-171
- Pfannenstiel H-D, Grünig C, Lücht J (1987) Gametogenesis and reproduction in nereidid sibling species (*Platynereis dumerilii* and *P. massiliensis*). Biol Soc Wash Bull 7:272-279
- Plate S, Husemann E (1991) An alternative mode of larval development in *Scoloplos armiger* (O. F. Müller, 1776) (Polychaeta, Orbiniidae). Helgol Meeresunters 45:487-492
- Rasmussen E (1973) Systematics and ecology of the Isefjord marine fauna (Denmark). Ophelia 11:1-507
- Reise K (1979) Spatial configurations generated by motile benthic polychaetes. Helgol Meeresunters 32:55-72
- Rice S, Simon J (1980) Intraspecific variation in the pollution indicator polychaete *Polydora ligni* (Spionidae). Ophelia 19:79-115
- Ridley M (1996) Evolution. Blackwell Scientific, Boston
- Schultze MS (1855) Über die Entwicklung von *Arenicola piscatorum* nebst Bemerkungen über die Entwicklung anderer Kiemenwürmer. Abh naturf Ges Halle 3:211
- Stripp K (1969) Die Assoziationen des Benthos in der Helgoländer Bucht. Veröff Inst Meeresforsch Bremerhaven 12:95-141
- Sveshnikov VA (1960) Pelagic larvae of some polychaeta in the White Sea. Zool Zh 39:343-355
- Thamdrup HM (1935) Beiträge zur Ökologie der Wattenfauna auf experimenteller Grundlage. Medd Danm Fisk Havunders (Ser Fiskeri) 10:1-125
- Weber K (1992) Fortpflanzung, Populationsdynamik und Lebensweise von *Scoloplos armiger*. Diploma Thesis, Christian-Albrechts-Universität Kiel. pp. 1-69.
- Wesenberg-Lund E (1950) The polychaeta of West Greenland. Medd Grönland 151:1-171
- Ziegelmeier E (1978) Macrobenthos investigations in the eastern part of the German bight from 1950 to 1974. Rapp P-v Réun Cons int Explor Mer 172:432-444

Chapter 4

The role of ecological divergence in speciation between intertidal and subtidal *Scoloplos armiger* (Polychaeta, Orbiniidae)

Inken Kruse, Matthias Strasser, Frank Thiermann

Abstract

The model of ecological speciation implies that habitat differences may split a species by strong selection and rapid adaptation even under sympatric conditions. Recent studies on the polychaete *Scoloplos armiger* in the Wadden Sea, North Sea, indicate sibling species existing in sympatry: the intertidal 'Type I' with holobenthic development out of egg cocoons and the subtidal 'Type S' shedding pelagic larvae into the open water. In the current study, Type I and S are compared in habitat-related traits of reproductive timing and physiological response to hypoxia and sulphide. Spawning of Type I and Type S recorded over six years overlap in spring and both appear to be triggered by rise in sea temperature above 5°C. Type S exhibits an additional autumn spawning which was unknown till now and is absent in Type I. High overall abundances of pelagic larvae in the Wadden Sea are shown. Since these have been neglected so far, reassessment of *S. armiger* population dynamics models is suggested. Tolerance against sulphide and hypoxia were both lower in Type S than in Type I. This correlates with a measured 5 to 10-fold lower sulphide concentration in the subtidal compared to the intertidal habitat. Physiological tolerance and divergence in developmental mode appear as traits which have ultimately led to reproductive isolation between Type I and Type S. Their role in allopatric and sympatric speciation scenarios in *S. armiger* is discussed.

Introduction

In cases of suspected speciation, elucidation of the ecological background of diverging populations may reveal pathways fundamental to the speciation process. Currently, attention to ecological details is making a comeback in this context, reviving the ecological speciation model (Morell 1999; Schluter 2001). According to this model the barriers that cause the origin of species can be ecological rather than geographic and selection may be paramount. A particular selective factor is assumed to push two populations down to separate evolutionary paths.

The polychaete *Scoloplos armiger* (O. F. Müller, 1776) is one of the most common macrofauna species of the eastern North Atlantic with purported cosmopolitan occurrence in all zoogeographic regions (Hartmann-Schröder 1996, p. 598). With its global distribution *S. armiger* populates environments as different as the tropics and the arctic, low and high salinities, intertidal and deep sea habitats. However, on a small scale within the Wadden Sea, significant divergence between intertidal and subtidal *S. armiger* has been discovered leading to the suggestion that two sympatric sibling species exist: the intertidal named 'Type I' and the subtidal named 'Type S' (Kruse et al. submitted; Kruse and Reise submitted). Traits distinguishing the two types are (1) mode of development which is holobenthic in egg cocoons in the intertidal zone and pelagic for subtidal specimens, (2) genetic markers, (3) morphology of spermatozoa and anal cirri and (4) an unknown divergence leading to reproductive isolation in a crossbreeding experiment.

Several polychaete sibling species have been indicated through analysis of ecological divergence. Reproductive timing (Healy and Wells 1959; Gibbs 1971; Christie 1982; Christie 1985; Westheide and Rieger 1987) and physiological responses (Mangum 1963; Curtis 1978; Rice and Simon 1980; Gamenick et al. 1998b) have been revealed as important diverging characters.

The pelagic mode of development has been attributed explicitly to *S. armiger* only a decade ago by Plate and Husemann (1991). Before, an exclusively holobenthic development has been assumed. The existence of pelagic larvae implies a much higher dispersal potential for this species than taken for granted so far in assessments of population dynamics of *S. armiger*. As yet, only Plate and Husemann (1991) provided information on seasonal larval occurrence in the plankton, solely referring to

the island of Helgoland, North Sea. They found pelagic *S. armiger* larvae occurring for eight weeks between February and April in the course of three spring seasons. Larvae were of different developmental stages, individually stay about 11 days in the water column and are lecithotrophic like their intertidal congeners.

S. armiger is classified as a mobile, vagile, infaunal subsurface deposit feeder (Fauchault and Jumars 1979; Hongguang et al. 1995). It lives in many sediment types in depths down to 15 cm and normally does not appear at the sediment surface. In the intertidal, *S. armiger* is faced with diminished oxygen supply like all other members of the infauna when the tidal flats are exposed at low tide (Schöttler 1980). Intertidal *S. armiger* are adapted to these conditions by producing energy via anaerobic metabolism (Schöttler and Grieshaber 1988), subtidal *S. armiger* have not been tested. Oxygen depletion but also sulphide accumulation are regarded as belonging to the key factors in the benthic environment (Giere 1992). Both factors are correlated in that sulphide originates under anoxic conditions within the sediment and is oxidized to harmless compounds in the presence of oxygen. The effect of sulphide, known to intensify the effect of hypoxia in invertebrates (Vismann 1991), has as yet not been tested for both subtidal and intertidal *S. armiger*. Sulphide concentrations are higher in depositional systems like the intertidal where usually the finer organic material settles and lower in the organic-poorer subtidal which is subject to stronger water currents (de Wilde and Beukema 1984). These differences between habitats make hypoxia and sulphide tolerance one possible factor for divergent or disruptive selection during sympatric speciation in *S. armiger*.

In the first part of this study, we provide a *S. armiger* plankton survey of six years, 1996 to 2001, from the Wadden Sea off the island of Sylt. Temporal occurrence of pelagic larvae will be compared with egg cocoon spawning in the intertidal. The quantitative significance of pelagic larvae in this area shall be assessed. The second part of this study will comprise an experimental comparison of subtidal and intertidal *S. armiger* in their tolerance to hypoxic and sulphidic environments. The sediment of both habitats will be characterised in sulphide concentration, pH and grain size.

Materials and methods

Study area

Scopelos armiger was collected in the Sylt-Rømø Bight, a tidal basin in the North Sea. The bight is part of a continuous tidal area extending over 500 km of coastline, called the "Wadden Sea". Tides are semidiurnal with a range of about 2 m. The Sylt-Rømø Bight covers about 400 km², of which 33% belong to the intertidal zone, 57% to the shallow subtidal (<5m depth) and 10% to deeper tidal channels (max. depth ~ 40m). Water exchange between the Sylt-Rømø Bight and the open North Sea takes place through a 2.8 km-wide tidal channel. More information about the area is given in Gätje and Reise (1998).

Sampling and field survey

Samples to record planktonic *S. armiger* larvae over the course of more than 6 years were taken from the seaward end of the ferry landing pier close to List harbour (see Strasser and Günther 2001). From May 1996 to December 2001, 10 dm³ of surface water were sampled daily from March to October and weekly from November to February. For the period January - May 1996 the dataset was supplemented by a long-term monitoring programme in which 35 dm³ of surface water was sampled biweekly in the Lister Ley (Martens 1995). Measurements of water temperature were obtained biweekly from the same programme.

Plankton samples for the examination of larval distributions on a larger temporal and spatial scale were taken in the year 2000 to assess if samples from of the List harbour site are representative. For testing the vertical stratification, three water depths (1, 5, 10 m) were sampled from a boat during the spring spawning time using a 9 dm³ Niskin Bottle, on March 22 at high and low tide and on March 24 at low tide at six sites along the gully Lister Ley (Fig. 4.1). Horizontal larval distribution was surveyed by comparing larval abundances among sites from 35 dm³ of surface water from each site on the same cruises as the vertical sampling plus one high tide on March 20. A survey of larval abundances on a larger temporal scale was performed on 30 successive tides (15 high tides and 15 low tides, night and day) between March 20 and March 28. For night-day comparisons only the same tides (high and low water) were compared and, accordingly, comparisons of high and low tide abundances were done only within night

and within day samples. All plankton samples were sieved through a 80 μm mesh and processed fresh on return to the laboratory.

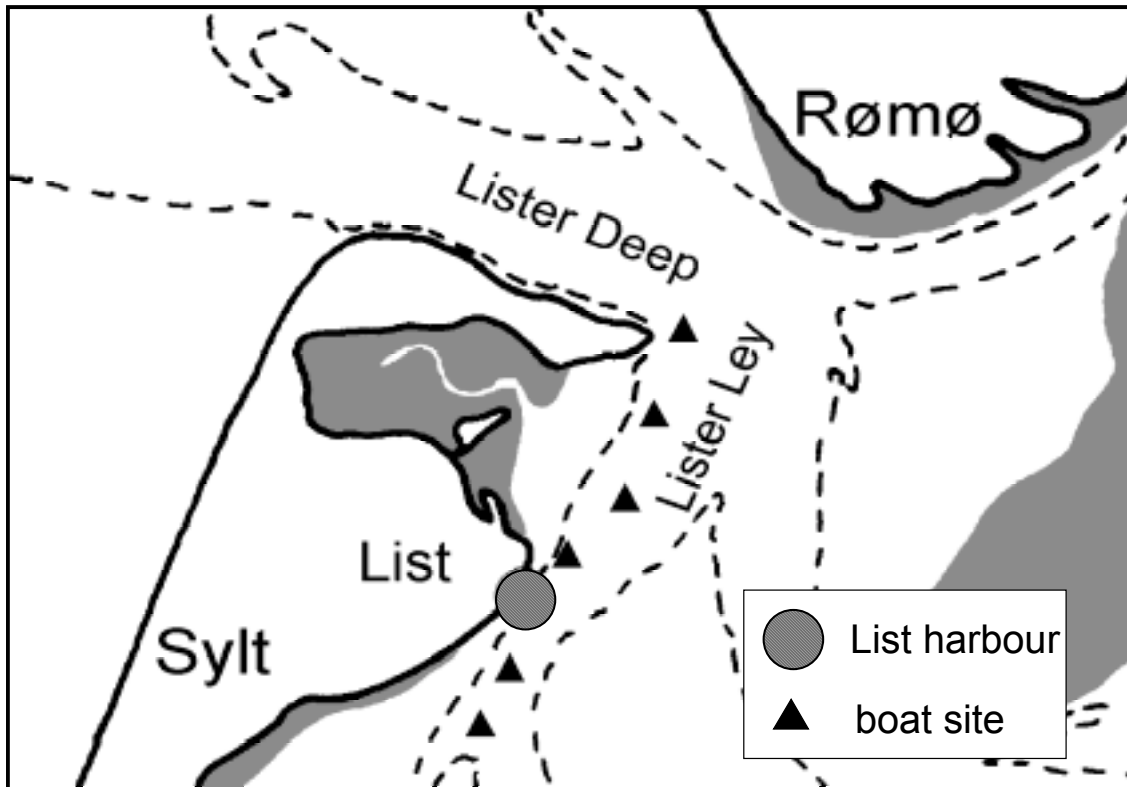

Fig. 4.1 Plankton sample sites with List harbour used for long-term survey and boat sites to examine spatial distribution (northernmost site 1 at 55° 02,64 N; 08° 28,00 E, southernmost site 6 at 54° 00,31 N; 08° 25,81 E)

The spawning of egg cocoons was surveyed regularly on the intertidal flats "Odde" and "Königshafen" every 2-4 days during the months February to April and October in the years 1996 - 2001. Since egg cocoons are not spawned in synchrony and their emergence varies in space and time (Gibbs 1968), the date of their first notable increase in overall abundance was recorded.

For the sulphide tolerance experiment adult *Scoloplos armiger* were sieved with a 1 mm mesh from intertidal and subtidal sediments of location "Odde", at six, resp. seven days before the experiment. Until start of the experiment the worms were kept at 5°C. The location "Odde" refers to earlier genetic, cross-breeding and morphological studies on *S. armiger* (see Fig. 4.1 in Kruse and Reise submitted; Kruse et al. submitted).

For the determination of sulphide concentrations, salinity and pH, porewater samples were taken after Howes et al. (1985). The location "Odde" was sampled in April at six sites and in June at eight or six sites (5 and 10 and 15 cm sediment depth), in the intertidal as well as in the subtidal habitat. Subtidal samples were taken on a boat within the box corer which contained the sediment from 10 m water depth. In the laboratory, total sulphide concentration was determined colourimetrically following Howarth et al. (1983). The term sulphide refers here to total dissolved sulphide, i.e. undissociated H_2S , dissociated HS^- and S^{2-} . Sediment grain size in the intertidal and subtidal habitat was determined following Giere et al. (1988).

Tolerance against sulphidic and hypoxic conditions

The survival of subtidal and intertidal *Scoloplos armiger* under hypoxic, sulphidic and normoxic (control) conditions was studied in June 2000. For each experimental condition, eight specimens were incubated at room temperature in glass jars (Schott standard wide neck bottles, vol= 250 ml) containing 3 cm of subtidal sediment and sea water. Each treatment was replicated three times. Initially pH-values were adjusted to 8.0 (using HCl, NaOH, HEPES buffer) and was determined again at the end of experiments. Severe hypoxia was obtained by percolation with nitrogen for 1 h, which reduced the oxygen tension below the detection limits of polarographic oxygen electrodes ($<1 \mu\text{mol O}_2 \text{ l}^{-1}$, Gamenick et al. 1998a). The initial sulphide concentration of 220 μM in the sulphide treatment was achieved by addition of a 10 mM stock solution (made from $\text{Na}_2\text{S} \cdot 9\text{H}_2\text{O}$ crystals). Sulphide concentrations were measured at the beginning and the end of experiments, as described above. For exact experimental conditions see Table 4.1.

Table 4.1 Tolerance experiments: mean sulphide concentration and pH

	Start	End	Mean
Sulphide concentration (μM)	223	168	195
pH-value	7.9	7.5	7.7

After insertion of the polychaetes, the jars were closed and submerged in a seawater bath which was permanently percolated with nitrogen to prevent influx of oxygen. Normoxic control replicates stood open in a water bath that was aerated with

atmospheric air. Survival of the worms was recorded without removing the worms from the jars. The survival-rates were controlled every second hour, after 33 hours every hour and after 49 hours again every second hour until the end of the experiment. Worms were considered dead when no tactile response was observed after stirring. Hence, "mortality" in the present paper refers to both anaesthetized and dead worms. Mean sizes of the experimental worms were $1.52 \text{ mm} \pm 0.33$ thorax width, ranging between 0.76 and 2.24 mm. There was no significant difference in worm sizes between treatments (t -test, $p > 0.1$). Mean lethal time ($=LT_{50}$, i.e. the point in time or time span when four worms were dead) was determined for all treatments and populations.

Results

Spawning

In all years pelagic *S. armiger* larvae were found both in spring and in autumn with higher abundances in spring (Fig. 4.2). In contrast, intertidal *S. armiger* produce egg cocoons in spring only. The date of first high increase of egg cocoons usually falls within the period of pelagic larval presence. All spring spawnings of pelagic larvae recorded over seven years started in February or March, coinciding with a water temperature approaching 5°C . As maximum abundance, we recorded $29 \text{ } S. \textit{armiger}$ larvae $\cdot 10 \text{ dm}^{-3}$ in spring. Autumn spawnings occurred in October with a maximum of $5 \text{ larvae} \cdot 10 \text{ dm}^{-3}$.

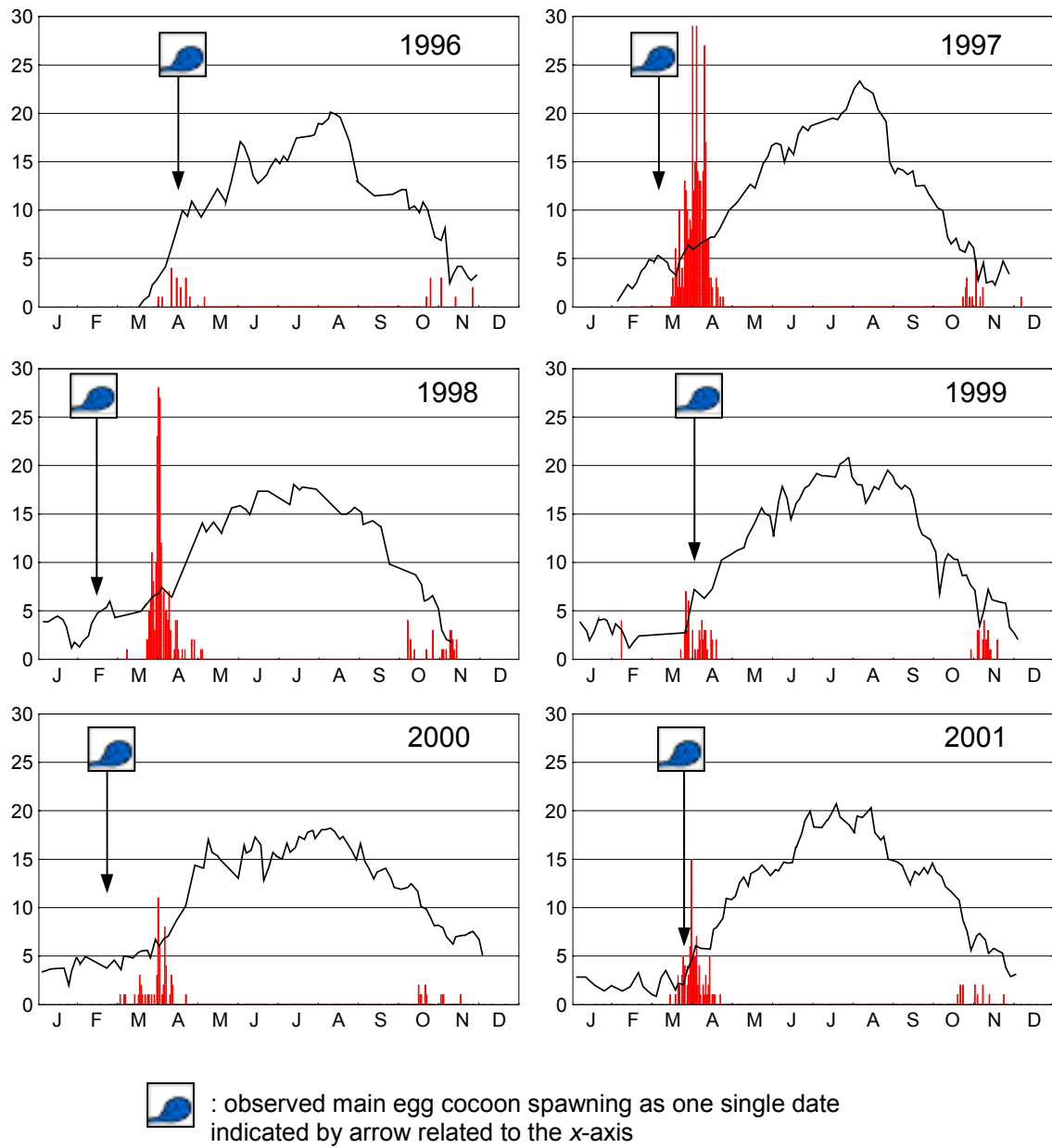

Fig. 4.2 Abundances of pelagic *Scoloplos armiger* larvae 1996-2001 at List harbour, in columns related to left y-axis. Water temperatures in lines related to right y-axis.

Plankton samples collected at a larger spatial scale support that our long-term sampling from List harbour can be regarded as representative for at least the water body in the gully Lister Ley. There was no significant difference in the number of pelagic larvae at three water depths (10, 5 and 1m) (t -test $p > 0.05$) (Table 4.2). The abundances of the List harbour are in the same range with the ones at the six Lister Ley sites. Mean values were slightly higher at List harbour but there was no significant difference to the Lister Ley sites (t -test $p > 0.05$, $n = 4$) (Table 4.2). At a higher temporal resolution by sampling 30 successive tides (15 high tides and 15 low tides), a higher larval abundance at night was detected (Wilcoxon-test, $p < 0.05$, $n = 13$ pairs; mean: $7.1 \text{ larvae} \cdot 10 \text{ dm}^{-3}$). Higher abundances at low tide compared to high tide were not significant (Wilcoxon-test, $p > 0.05$, $n = 13$ pairs; mean: $6.7 \text{ larvae} \cdot 10 \text{ dm}^{-3}$).

Table 4.2 Large scale distribution of pelagic *Scoloplos armiger* larvae in mean abundances \pm standard deviation. Vertical distribution defined by three water depths, horizontal distribution defined by six sites in Lister Ley, plus List harbour site.

water depth	1 m	5 m	10 m				
mean * 10 dm^3 (\pm SD)	1.4 ± 1.4	1.3 ± 1.3	1.3 ± 1.3				
site in Lister Ley	1	2	3	4	5	6	List harbour
mean * 10 dm^3 (\pm SD)	1.2 ± 1.3	1.1 ± 0.5	0.4 ± 0.3	1.4 ± 1.1	1.1 ± 0.6	1.1 ± 1.1	2.2 ± 2.3

Abiotic sediment- factors

In the field, sulphide concentrations in the intertidal were significantly higher, i.e. between 5 and 10-fold, than at the subtidal sampling site. Higher sulphide concentrations were accompanied by lower pH (Table 4.3). Sediment grain size in the intertidal (moderately sorted fine sand) was similar as in the subtidal, only a little coarser (moderately sorted medium sand) (Table 4.3).

Table 4.3 Abiotic sediment characteristics from subtidal and intertidal site, where *Scoloplos armiger* for hypoxia and sulphide tolerance experiment were sampled.

		intertidal			subtidal		
		mean	SD	n	mean	SD	n
<u>sulphide ($\mu\text{mol} \cdot \text{l}^{-1}$)</u>							
April							
sediment depth:	5 cm	106.22	32.70	6	12.93	6.72	6
	10 cm	98.73	35.60	6	11.90	5.52	6
	15 cm	87.27	20.88	6	17.00	8.94	6
June							
sediment depth:	5 cm	70.10	16.49	8	15.3	3.4	6
	10 cm	78.69	25.06	8	9.5	5.6	6
<u>pH</u>		7.80	0.19	5	8.06	0.24	35
<u>grain size</u>	MD	423.94	18.24	16	291.87	54.32	23
	QDI	0.81	0.03	16	0.78	0.13	23
classification		moderately sorted medium sand			moderately sorted fine sand		

Tolerance against sulphide and hypoxia

Experiments testing tolerance to hypoxia and against sulphide revealed a higher sensitivity of subtidal *S. armiger* compared to intertidal specimens. LT_{50} value for intertidal *S. armiger* subject to anoxic conditions was 46 hours and for subtidal specimens between 36 and 37 hours (Fig. 4.3). Hypoxic and sulphidic conditions together lead to a LT_{50} of 39 for intertidal *S. armiger* and of 31 - 33 hours for subtidal specimens (Fig. 4.3).

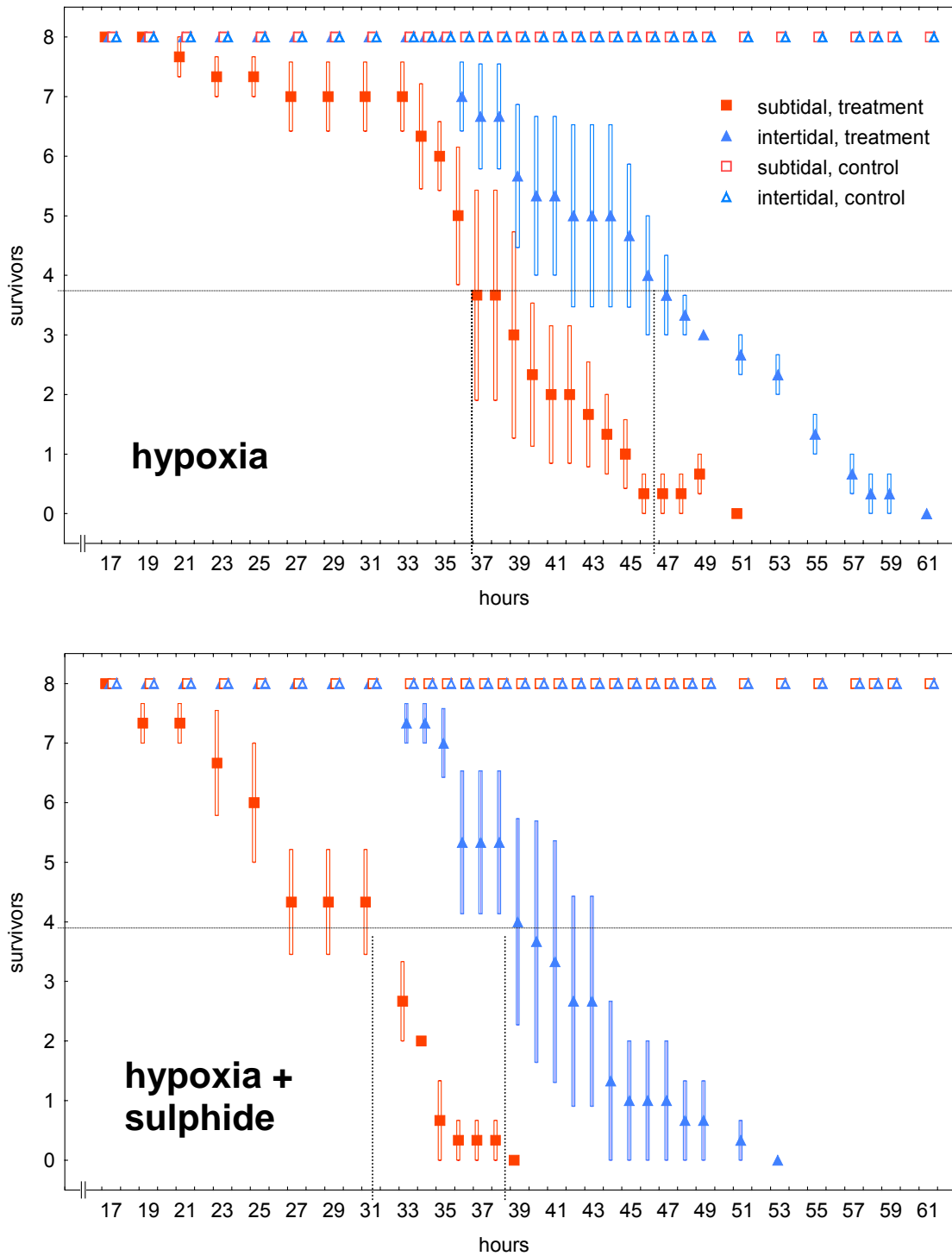

Fig. 4.3 Mean survival of *Scoloplos armiger* after starting with 8 subtidal and intertidal adults under hypoxia (graph above) and under hypoxia plus sulphide (graph below), \pm SE; LT₅₀ indicated by dotted line

Discussion

Populations inhabiting different environments may reflect this divergence by adaptation either as a plastic response or as genetic distinctness resulting from differential selection in the particular habitats. If the latter case is involved in geographically isolated populations reproductive isolation may arise as a by-product of this divergence. In sympatric populations reproductive isolation may be driven by selection when gene flow is not too high and selective pressure is strong enough (Via 2001). Disruptive selective pressures may be revealed from population divergence which is directly linked to habitat differences. Then it may be possible to assess which role habitat differences play in a speciation process, probing the proximate and ultimate causes.

Reproductive timing in intertidal and subtidal habitat

Spawning asynchrony is a conspicuous difference between many marine sibling species living in sympatry (Knowlton 1993) and between closely related polychaetes (Giangrande 1997). It may establish reproductive isolation in a simple way while spawning is most often triggered differently by environment. However, our results show that the hypothesis of spawning asynchrony of intertidal and subtidal *S. armiger* as cause for reproductive isolation is to be rejected. Spring spawning of both populations overlap temporally, representing the first evidence of both populations within one area. Earlier reports of spawning periods of egg cocoons given by Gibbs (1968) for Whitstable, east coast of Scotland, and for pelagic larvae given by Plate and Husemann (1991) for Helgoland already match exactly, and also with our results, all reporting the period late February to April.

Discussion of triggers of spawning and their divergence in the intertidal and subtidal habitat may be neglected due to the temporal overlap of spawnings in spring. However, our results suggest a rise in sea temperature above 5°C to be the main trigger for spawning of pelagic larvae and seems to be of significance also for the intertidal population (Wolff 1973). Gibbs (1968) reports occurrence of egg cocoons at Whitstable when the sea temperature is above 5°C, but also observed increased spawning after spring tides.

In autumn we registered a second spawning of pelagic larvae, which is the first explicit proof for *S. armiger*. Plate and Husemann (1991) did not sample in autumn. Only

Giere (1968) found pelagic *S. armiger* larvae in autumn in the North Sea but attributes these to eroded stages from an autumn benthic spawning, referring to Smidt (1951) who suspects this after finding 1- 2 mm long juveniles in December. To our knowledge, egg cocoons of *S. armiger* have never been reported in autumn. Thus, absence of an autumn spawning of egg cocoons by the intertidal population represents a reproductive divergence to the subtidal population. The adaptive value of absence of a second spawning is at hand for the intertidal population. Different from the subtidal habitat intertidal juveniles starting their development in autumn would be faced with death by freezing when the flats are exposed at winter low tide. Juveniles inhabit the upper mm of the sediment and are, other than adults, not able to retreat deeper into frost-safe layers. Review of other polychaete species occurring in the intertidal reveals that only those species spawn in autumn which send their juveniles into the subtidal or low intertidal, undertaking re-immigration to the upper intertidal in the next spring. *Arenicola marina* is one prominent example in this context (Reise 1985).

Results of our plankton survey stresses the so far underestimated quantitative significance of pelagic *S. armiger* larvae in the shallow Wadden Sea. Our maximum abundances exceed those recorded off Helgoland 300-fold (Plate and Husemann 1991). Higher water depths around Helgoland causing a thinning effect of larvae appears as likely reason for higher larval abundance in the Wadden Sea. Our plankton sampling on extended spatial and temporal scales confirm that our long-term sampling from List harbour can be regarded as representative for at least the water body in the gully Lister Ley and that tidal currents prevent stratification of mesozooplankton in the water body in the Sylt-Rømø Bight (Hickel 1975; Martens 1995).

Tolerance to hypoxia and sulphide

Intertidal *S. armiger* are, different from subtidal specimens, subject to hypoxia when tidal flats are cut off from supply with oxygenated sea water during low tide. As confirmed by our field data, hypoxia is mostly associated with free sulphide. Accordingly, intertidal *S. armiger* turned out to be better adapted to hypoxic and hypoxic plus sulphidic conditions in the experiment.

Tolerance of hypoxic conditions in intertidal *S. armiger* is based on the ability of anaerobic energy production as shown by Schöttler and Grieshaber (1988). These authors observed anaerobic metabolism maintained for 24 h before greater mortality

occurred and a 40 h threshold for survival determined by total exploitation of glycogen reserves. This 40 h threshold is 5 hours below the LT_{50} in our experiment. Presumably, longer survival of our worms is based on more natural experimental conditions by providing sediment within the experimental jars. However, Schöttler and Grieshaber's classification of *S. armiger* as a species with moderate resistance to anoxia as compared with other infaunal marine invertebrates (Schöttler et al. 1984; Gamenick et al. 1998b; Thiermann et al. 2000) still appears valid in spite of this diverging results. Tolerance against sulphide depends on the performance of a sulphide detoxification system. Like the tolerance against hypoxia this has been shown to be species-specific in marine invertebrates (Vismann 1990; Völkel and Grieshaber 1994; Gamenick et al. 1998b; Gamenick et al. 1998b; Hauschild et al. 1999). In conclusion, physiological adaptations to both, hypoxia and sulphide appear as traits under selection during speciation in *S. armiger*.

Role of adaptation to subtidal and intertidal habitat in a speciation process

Distinct gene pools between subtidal and intertidal *S. armiger* characterized by neutral, random markers (Kruse et al. submitted) suggest that the potential of both populations to adapt to hypoxia and sulphide may be genetically fixed. Poor performance in anaerobiosis and sulphide detoxification in *S. armiger* Type S may exclude them from invasion of the intertidal and thus isolate them from the Type I population. Decision on the significance of divergence in physiological adaptation during the speciation process depends on which speciation model is followed and what is to be regarded as the ultimate cause for reproductive isolation. If speciation has occurred under the distributional situation present in the Wadden Sea, a sympatric speciation scenario is to be followed. By allopatric speciation, reproductive isolation has emerged under geographic separation of at least one *S. armiger* population in an area distant from the Wadden Sea, with later invasion of this area. In this speciation scenario reproductive isolation evolves as a by-product of population divergence in the absence of gene flow. In contrast, in the sympatric scenario gene flow may be present during population divergence. One prerequisite for speciation under sympatric conditions is that selection is strong enough and gene flow is not too high (Via 2001). Additionally, the traits under divergent selection must provide intrinsic barriers to gene flow, as shown in the valid examples of sympatric speciation (Via 2001). Since holobenthic development is considered as the derived condition in polychaetes

(Schroeder and Hermans 1975), in both scenarios *S. armiger* Type I is regarded as the derived and Type S as the ancestral species.

In case physiological adaptation was the ultimate cause of divergence in *S. armiger*, only an allopatric scenario of speciation appears possible. There is no obvious propensity of these physiological traits to build up intrinsic barriers to gene flow. In this scenario a species splits up from an ancestral *S. armiger* under selection for high physiological tolerance to anoxia and sulphide in a geographically isolated area, keeping pelagic larvae. These are able to invade the intertidal as a novel habitat since they are preadapted to it in their physiological tolerance. Egg cocoons then have emerged as a secondary trait in the intertidal. *S. armiger* from the Baltic may represent such a distant population preadapted to invade the intertidal. It is attributable to the subtidal *S. armiger* Type S lacking egg cocoons (Kruse and Reise submitted), have been reported to tolerate low oxygen concentration, withstand presence of hydrogen sulphide and are the only infaunal species involved in bioturbation process in large suboxic areas below the subhalocline in the Eastern Gotland and Northern Basins (Schulz 1969; Olenin and Schiedek 1996). However, if Baltic *S. armiger* are reproductively isolated from the North Sea Type S needs to be examined.

Formation of egg cocoons emerging prior to physiological adaptation allows both an allopatric and a sympatric scenario. In the allopatric scenario at some coastal part of the distributional range of *S. armiger*, strong selective pressure occurs against pelagic larvae, i.e. by strong and only offshore currents or very heavy larval mortality (predation, high annual variation in suitable water masses etc.). This coastal part becomes geographically isolated and the direct mode of development in egg cocoons emerges as an adaptation to selective pressure. After the geographic barrier is abolished, *S. armiger* with advanced direct development turned out to be pre-adapted to evolve specific tolerances required for survival in the intertidal zone.

According to a sympatric speciation model, larval development within egg cocoons may represent the only way for *S. armiger* to colonize the harsh intertidal environment exhibiting shifting sands during high tide and extreme temperatures with threat of desiccation during low tide. Only some specimens invading the intertidal which have the phenotypically plastic ability to develop egg cocoons may keep their genes in the intertidal or in the transition zone, all others are sent away with pelagic larvae in the next generation. Continual retention of larvae and assortative mating within the

intertidal habitat provided by development in egg cocoons reinforces adaptation to the intertidal habitat, e.g. in physiological tolerance. In turn does the environmentally induced dying off of pelagic larvae reaching the intertidal or avoidance of the intertidal and poor adaptation of adults to anoxia and sulphide prevent to blur the gene pool of the intertidal population. Intrinsic barriers to gene flow emerge.

However, decision for one of these scenarios to be the most likely needs further investigation. Genetic tests for phylogenetic relatedness between subtidal and intertidal populations of *S. armiger* relative to the other species of this genus on the one hand and of subtidal *S. armiger* on a global range on the other hand appears to be a promising approach. Combined with information on dispersal, physiology and reproductive behaviour of the populations these data then may elucidate processes of ecological speciation in *S. armiger* which may be fundamental in the marine environment.

References

- Christie G (1982) The reproductive cycles of two species of *Pholoe* (Polychaeta: Sigalionidae) off the Northumberland coast. *Sarsia* 67:283-292
- Christie G (1985) A comparative study of the reproductive cycles of three Northumberland populations of *Chaetozone setosa* (Polychaeta: Cirratulidae). *J mar biol Ass UK* 65:239-254
- Curtis LA (1978) Aspects of the population dynamics of the polychaete *Sabellaria vulgaris* Verrill, in the Delaware Bay. *Estuaries* 1:73-84
- de Wilde P, Beukema JJ (1984) The role of the zoobenthos in the consumption of organic matter in the Dutch Wadden Sea. *Publ Ser Neth Inst Sea Res* 10:145-158
- Fauchault K, Jumars PA (1979) The diet of worms: a study of polychaete feeding guilds. *Oceanogr Mar Biol Annu Rev* 17:193-284
- Gamenick I, Abbiati M, Giere O (1998a) Field distribution and sulphide tolerance of *Capitella capitata* (Annelida: Polychaeta) around shallow water hydrothermal vents off Milos (Aegean Sea). A new sibling species? *Mar Biol* 130:447-453
- Gamenick I, Vismann B, Grieshaber MK, Giere O (1998b) Ecophysiological differentiation of *Capitella capitata* (Polychaeta). Sibling species from different sulfidic habitats. *Mar Ecol Prog Ser* 175:155-166
- Gätje C, Reise K (1998) Ökosystem Wattenmeer, Austausch-, Transport- und Stoffumwandlungsprozesse. Springer, Berlin
- Giangrande A (1997) Polychaete reproductive patterns, life cycles and life histories: an overview. *Oceanogr Mar Biol Annu Rev* 35:323-386

- Gibbs PE (1968) Observations on the population of *Scoloplos armiger* at Whitstable. J mar biol Ass UK 48:225-254
- Gibbs PE (1971) A comparative study of reproductive cycles in four polychaete species belonging to the family Cirratulidae. J mar biol Ass UK 51:745-769
- Giere O (1968) Die Fluktuationen des marinen Zooplanktons im Elbe-Aestuar. Arch Hydrobiol (Suppl) 3/4:379-546
- Giere O (1992) Benthic life in sulfidic zones of the sea (ecological and structural adaptations to a toxic environment). Ver Dtsch Zool Ges 85:77-93
- Giere O, Eleftheriou A, Murison DJ (1988) Abiotic factors. In: Higgins RP, Thiel H (eds) Introduction to the study of meiofauna. Smithsonian Institution, pp 61-78
- Hartmann-Schröder G (1996) Polychaeta. G. Fischer, Stuttgart
- Hauschild K, Weber W-M, Clauss W, Grieshaber MK (1999) Excretion of Thiosulphate, the main detoxification product of sulphide, by the lugworm *Arenicola marina* L. J Exp Biol 202:855-866
- Healy EA, Wells GP (1959) Three new lugworms (Arenicolidae, Polychaeta) from the north Pacific area. Proc. Zool. Soc. Lond. 133:315-335
- Hickel W (1975) The mesozooplankton in the Wadden Sea of Sylt (North Sea). Helgol Meeresunters 27:254-262
- Hongguang M, Zhiying Y, Cadée GC (1995) Macrofauna distribution and bioturbation on tidal confluences of the Dutch Wadden Sea. Neth J Aquat Ecol 29:167-176
- Howarth RW, Giblin A, Gale J, Peterson BJ, Luther GW (1983) Reduced sulfur compounds in the pore waters of New England salt marsh. Ecol Bull 35:135-152
- Howes BL, Dacey JW, Wakeham SG (1985) Effects of sampling technique on measurements of porewater constituents on salt marsh sediments. Limnol Oceanogr 30:221-227
- Knowlton N (1993) Sibling species in the sea. Annu Rev Ecol Syst 24:89-216
- Kruse I, Reise K (submitted) Reproductive isolation between intertidal and subtidal *Scoloplos armiger* (Polychaeta, Orbiniidae) indicates sibling species in the North Sea. Mar Ecol Prog Ser
- Kruse I, Reusch TBH, Schneider MV (submitted) Sibling species or poecilogony in the polychaete *Scoloplos armiger*? Mar Biol
- Mangum CP (1963) Studies on speciation in maldanid polychaetes of the North American Atlantic coast - III. Intraspecific and interspecific divergence in oxygen consumption. Comp Biochem Physiol 10:335-349
- Martens P (1995) Mesozooplankton in the northern Wadden Sea of Sylt: seasonal distribution and environmental parameters. Helgol Meeresunters 49:553-562

- Morell V (1999) Ecology returns to speciation studies. *Science* 284:2106-2108
- Olenin S, Schiedek D (1996) Is the polychaete *Scoloplos armiger* a biological marker of saline water inflows into subhalocline areas of the Baltic proper? Baltic Marine Science Conference. Rønne, Bornholm. Abstracts, p. 3
- Plate S, Husemann E (1991) An alternative mode of larval development in *Scoloplos armiger* (O. F. Müller, 1776) (Polychaeta, Orbiniidae). *Helgol Meeresunters* 45:487-492
- Reise K (1985) Tidal Flat Ecology. An experimental approach to species interactions. Springer, Berlin
- Rice S, Simon J (1980) Intraspecific variation in the pollution indicator polychaete *Polydora ligni* (Spionidae). *Ophelia* 19:79-115
- Schluter D (2001) Ecology and the origin of species. *Trends Ecol Evol* 16:372-380
- Schöttler U (1980) Der Energiestoffwechsel bei biotop-bedingter Anaerobiose: Untersuchungen an Anneliden - The energy metabolism during facultative anaerobiosis: investigations on annelids. *Ver Dtsch Zool Ges* 1980:228-240
- Schöttler U, Grieshaber M (1988) Adaption of the polychaete worm *Scoloplos armiger* to hypoxic conditions. *Mar Biol* 99:215-222
- Schöttler U, Surholt B, Zebe E (1984) Anaerobic metabolism in *Arenicola marina* and *Nereis diversicolor* during low tide. *Mar Biol* 81:69-73
- Schroeder PC, Hermans CO (1975) Annelida: Polychaeta. Academic Press Inc., New York, San Francisco, London
- Schulz S (1969) Das Makrobenthos der südlichen Beltsee. *Beitr Meeresk* 26:21-46
- Smidt ELB (1951) Animal production in the Danish Waddensea. *Medd Danm Fisk Havunders (Ser Fiskeri)* 11:1-151
- Strasser M, Günther C-P (2001) Larval supply of predator and prey: temporal mismatch between crabs and bivalves after a severe winter in the Wadden Sea. *J Sea Res* 46:57-67
- Thiermann F, Visman B, Giere O (2000) Sulphide tolerance of the marine nematode *Oncholaimus campylocercoides* - a result of internal sulphur formation? *Mar Ecol Prog Ser* 193:251-259
- Via S (2001) Sympatric speciation in animals: the ugly duckling grows up. *Trends Ecol Evol* 16:381-390
- Vismann B (1990) Sulfide detoxification and tolerance in *Nereis (Hediste) diversicolor* and *Nereis (Neanthes) virens* (Annelidae: Polychaeta). *Mar Ecol Prog Ser* 59:229-238
- Vismann B (1991) Sulfide tolerance: physiological mechanisms and ecological implications. *Ophelia* 34:1-27

Völkel S, Grieshaber MK (1994) Oxygen-dependent sulfide detoxification in the lugworm *Arenicola marina*. Mar Biol 118:137-147

Westheide W, Rieger RM (1987) Systematics of the amphiatlantic *Microphthalmus-listensis*-species-group (Polychaeta: Hesionidae): Facts and concepts for reconstruction of phylogeny and speciation. Z Zool Syst Evolutionsforsch 25:12-39

Wolff WJ (1973) The estuary as a habitat. An analysis of the soft-bottom macrofauna of the estuarine area of the rivers Rhine, Meuse and Scheldt. Zool Verh 126:1-242

Chapter 5

Discussion

Introduction

In the following chapter I first summarize the available evidence that indicates the existence of two *S. armiger* species in the North Sea. Then I will outline the present-day geographic overlap of these species which yet exhibit segregation by habitat, and the mechanisms providing reproductive isolation between them. Subsequently I will discuss how this present-day situation may have evolved, resulting in three speciation scenarios for *S. armiger*. In the end, speciation of *S. armiger* will be considered in the light of general mechanisms of speciation in the marine environment.

Evidence for two sibling species of *Scoloplos armiger* in the North Sea

The present results indicate there to be two sibling species in *Scoloplos armiger*: 'Type I' living in the intertidal and 'Type S' living subtidally (Fig. 5.1). Differences in genetic markers and reproductive isolation between both types in the lab allow for this conclusion following the prerequisites that distinct species have distinct gene pools and do not produce fertile offspring according to the biological species concept. Further discrete developmental, morphological and physiological characters were detected to be significantly different (Fig. 5.1). They may have a genetic basis rather than being phenotypically plastic.

These results further call for a detailed comparison of 'Type I' and 'Type S' in adult morphology in the future since until now intertidal and subtidal *S. armiger* have always been classified as one species. In case diagnostic divergent morphological characters are found, these are valuable for routine identification. However, both *S. armiger* types may represent classical sibling species like the *Capitella* species complex where no consistent diagnostic morphological characters have been found to date. The discrete biological characteristics differing between the two *S. armiger* species thus may reflect a coexistence due to divergence which is unrelated to morphology and common in marine sibling species (Knowlton 1993).

Each of the divergent traits found in this study may represent a habitat-related adaptation or may have emerged due to reinforcement, co-evolution between sexes or by competition. For example, egg cocoons imply a lower dispersal in the intertidal

habitat than subtidal pelagic larvae. Production of these cocoons further may require an alteration in fertilization and higher energy expenditure, suggesting a strong connection with other life-history traits.

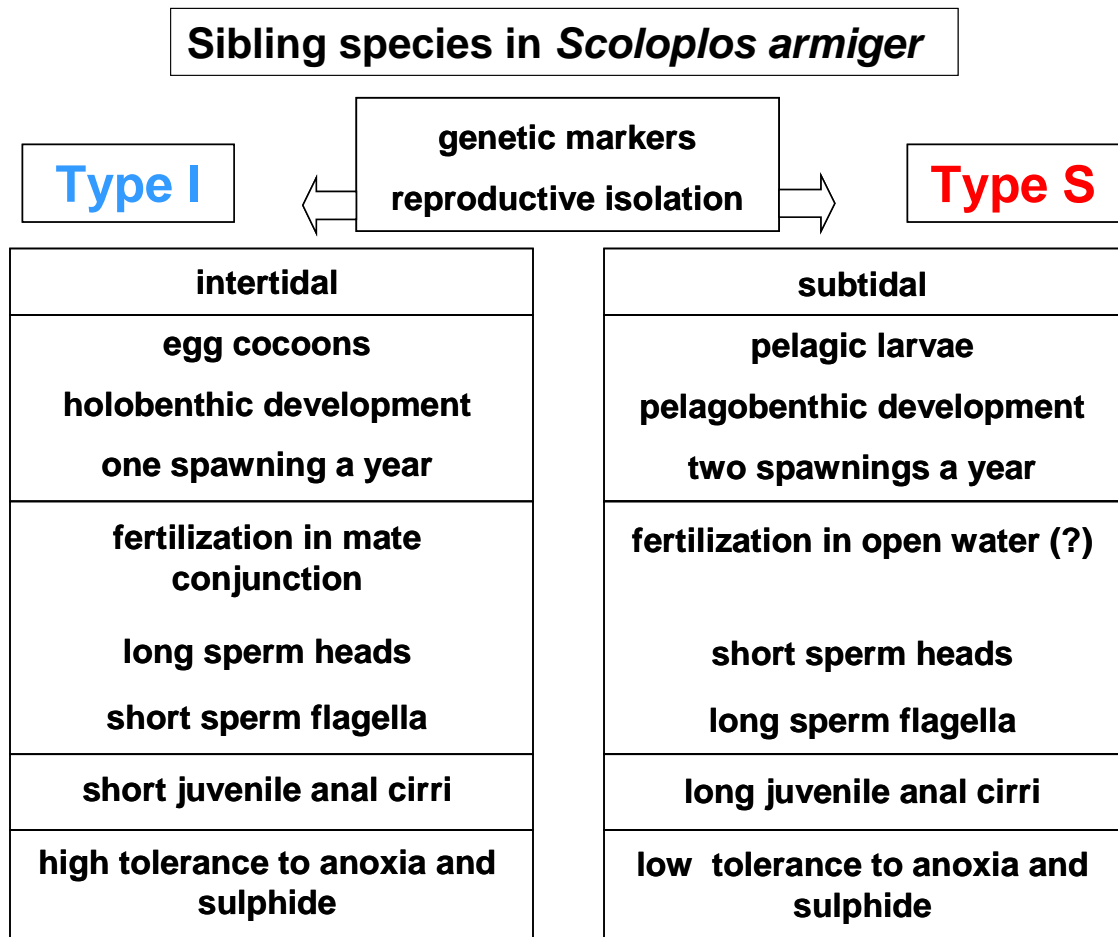

Fig. 5.1 Summary of traits diverging between two *Scoloplos armiger* sibling species

Present day scenario

Geographic overlap

Populations of *Scoloplos armiger* Type I and Type S in the North Sea may be classified as parapatric or sympatric with distinct habitat preferences. According to a definition by Mayr (1963, p. 449) sympatry is present when populations are not geographically isolated, when individuals of one population occur within the normal individual cruising range of the other population. There is no sharp barrier between the intertidal and subtidal habitat and the low tide level varies. Moreover, both habitats are

connected by tidal currents which represent a potent means of transportation for marine benthic organisms (Butman 1989; Zühlke and Reise 1994; Armonies 1994).

Distribution of the two *Scoloplos* types may be denoted as parapatric with respect to "abutting geographical ranges of the two populations" (Speciation Glossary 2001) or to "minor physical contact" only for a part of their range (Johannesson 2001).

For keeping within their distributional ranges under the outlined conditions *S. armiger* Type I and Type S must have developed distinct dispersal strategies (Fig. 5.2). The Type I population in the limited intertidal habitat is especially at risk to lose propagules to the extensive subtidal area. The areal extension of the two *S. armiger* habitats, intertidal and subtidal, is highly asymmetric. The intertidal habitat is only confined to a narrow zone. In the entire Wadden Sea the intertidal covers 4300 km² (Gätje and Reise 1998, p. 539), while in relation to that the subtidal habitat connected with the open oceans appears as an unlimited area. Egg cocoons provide a good means to retain *S. armiger* larvae within the intertidal habitat (Chapman 1965; Gibbs 1968) so that larvae exhibit fidelity to the parental habitat which is termed philopatry (Via 2001).

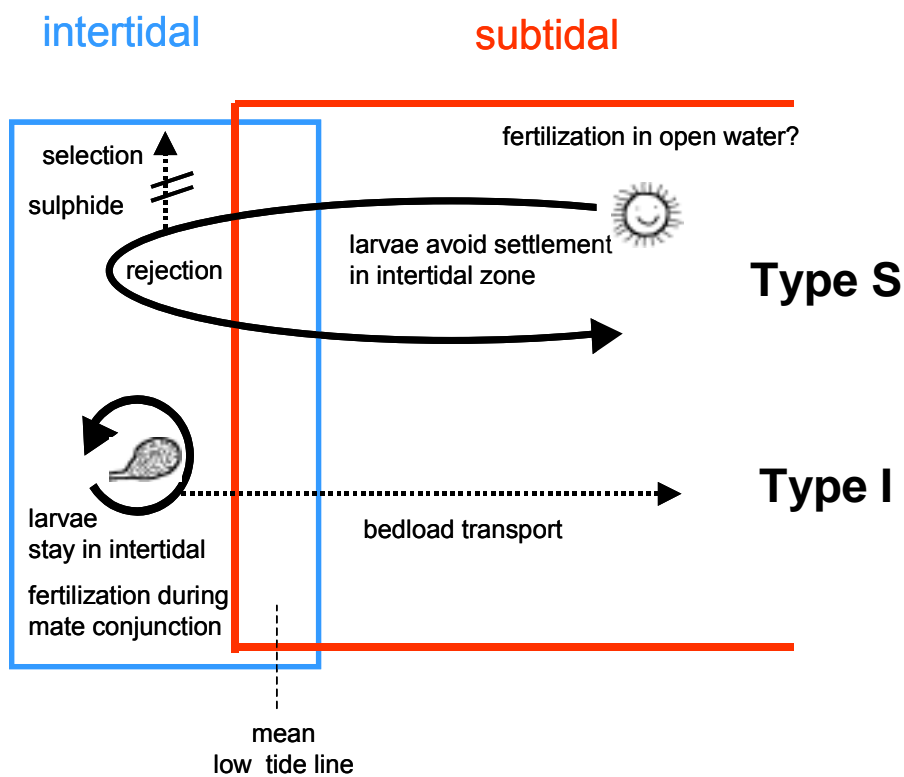

Fig. 5.2 Modelled mechanisms and properties of *Scoloplos armiger* Type I and Type S with the potential to limit a mix-up of intertidal and subtidal populations. All components refer to larvae, except fertilization modes which refer to adults

It appears likely that development within egg cocoons represents the only way to recruit in the intertidal habitat which may be difficult to settle with its shifting sands, temperature extremes and desiccation stress. Thus, protected development in fixed egg cocoons may represent an important preadaptation to establish in the intertidal. Reise (1979) found that 5 mm long and 3 months old juveniles prefer the subsurface sediment depth of 4 - 10 mm, confirming that juveniles invade the sediment after hatching and thus avoid dislocation.

Geographic segregation of habitat in *S. armiger* does not seem to be complete. A slight mix-up of the subtidal population by originally intertidal specimens due to bedload transport appears to be reflected by the present study. Results of genetic markers (see Chapter 2), of juvenile anal cirri divergence (see Chapter 3) and production of egg cocoons by some subtidal females in the breeding experiments (see Chapters 2 and 3) suggest immigration of Type I into the subtidal Type S population. Due to the possibility of such a mix-up, the operational categories "intertidal" and "subtidal" of this study do not imperatively refer to *S. armiger* Type I and Type S. No mix-up of Type S specimens within the Type I population was found in the present results, reflecting that migration between intertidal and subtidal habitat appears to be unidirectional. Either selection against migrants across the low tide line may occur by habitat-specific differential mortality, or subtidal *S. armiger* pelagic larvae avoid settling in the intertidal. Rejection of the intertidal as settlement substrate once transported there by water currents may occur. For long time it is recognized that many polychaete larvae discriminate between substratum types, showing pronounced preferences in their patterns of settlement (e.g. Knight-Jones 1953; Woodin 1986). High sulphide concentrations in the intertidal as found in this study is one possible factor to evoke this reaction. Another avoidance of the intertidal habitat may occur in that larvae are able to control their transport by depth-regulatory behaviour in tidal waters. Burton and Feldman (1982) suggested that strong-swimming larvae are able to perform this behaviour. Pelagic *S. armiger* larvae are to be classified as strong swimmers according to my own observations in the lab. In petri dishes under a dissecting microscope, *S. armiger* larvae were among the fastest directional swimmers of meroplankton organisms. Thus, the ability of depth-regulation to avoid transport into the intertidal might exist in *S. armiger* larvae but whether this might occur is not clear.

Reproductive isolation

Occurrence of *Scoloplos armiger* Type I and Type S in sympatry or parapatry means that no reproductive isolation by habitat exists. Instead, failure of offspring production in laboratory suggests other mechanisms. Two mechanisms of isolation can be inferred from the current results, both acting as prezygotic isolation. The first one, deviating sperm morphology, may cause the reproductive breakdown at the fertilization stage. The second one may impede mating already earlier. Provided that subtidal males and females of *S. armiger* Type S shed their eggs into the water column to fuse there, heterospecific mating with Type I would fail. Eggs packed into egg cocoons must be fertilized before embedding into the cocoon mass, which requires mating behaviour leading to conjunction of males and females inside the sediment within one tube. It has been postulated that eggs are fertilized immediately after they leave the body cavity of the female before the jelly has had time to swell (Chapman 1965). In fact, during egg cocoon production several female *S. armiger* have been observed within the sediment inside their tube next to their male mate (Weber 1992). Also in the cocoon spawning polychaete *Anaitides mucosa* sperms and eggs are shed right after cocoon jelly has been secreted (Sach 1975), representing the only detailed observation on mating behaviour of egg cocoon spawning polychaetes to my knowledge. However, an ethological barrier between Type I and S can only be assumed, since at present there is no direct evidence for free, external fertilization of eggs in the water column in Type S.

Evolutionary scenario of the emergence of reproductive isolation in *Scoloplos armiger*

After survey of existing mechanisms of reproductive isolation between closely related species, I will speculate which one of these was the most probable initial mechanism. Decision of what are ancestral and what derived traits divergent between species should be the next step in recapitulation of the speciation process. The adaptive value of these traits then may elucidate how and in which environments they have evolved. During speciation, once an initial mechanism is established, additional isolation mechanisms and other divergences may evolve fast. Hence, it may be difficult to deduce from the current situation which were the initial and which the subsequent divergences. Emergence of reproductive isolation also differs among species with

different hereditary disposition living in different environments so that contrasting models exist regarding how reproductive isolation evolves. Since the direct course of events during speciation processes can hardly ever be observed in nature, one has to rely on indirect inferences and arguments rest on plausibility.

Causes of reproductive isolation

Reproductive isolation between populations may either emerge as a random by-product of genetic differences accumulated in adaptation to alternative selection regimes and/ or genetic drift, or as a result of divergent or disruptive selection on an adaptive trait that is hereditarily linked with reproductive traits, causing reinforcing effects in the direction of reproductive isolation.

Mode of development and tolerance to hypoxia and sulphide are the two habitat-related, divergent traits in *S. armiger* to be inferred from the current study. Both may have emerged under divergent or disruptive selection present between intertidal and subtidal habitat. Since for the physiological adaptation no direct link to the emergence of a reproductive barrier is obvious, reproductive isolation resulting from this adaptation may have evolved only as a random by-product. In contrast, egg cocoon formation in *Scoloplos armiger* evolved as a new trait fundamentally altering life-history and reproductive traits. It subsequently may be followed by divergence in mating behaviour and sperm morphology as initial isolation mechanisms and thus may have acted as an ultimate cause for reproductive isolation. An inverse evolutionary order of these traits appears highly unlikely. Sperm morphology in polychaetes is correlated with fertilization biology. The sperm nucleus is more elongated in species that deviate from primitive spawning into the water column (Jamieson and Rouse 1989). Fertilization before packing the eggs into a cocoon requires such a modified sperm transfer. Thus, changes in mating behaviour and sperm morphology as obligate secondary consequences should evolve together with the emergence of egg cocoons.

By its effect of reducing juvenile dispersal, egg cocoons may facilitate further adaptations. Provided that the trait of egg cocoon formation has not emerged in an abrupt evolutionary switch coupled with fertilization breakdown as mentioned above, its effect of decreasing the dispersal of hatched juveniles may gain importance in development of reproductive isolation. Lower dispersal may enhance assortative mating within the habitat of egg cocoon emergence, reinforcing further adaptation and

divergence from the ancestral population. Reproductive isolation then could have emerged as a by-product of rapid adaptive divergence.

Phylogenetic constraints for egg cocoon emergence

Egg cocoon formation and direct development most likely are to be regarded as derived traits in *Scoloplos armiger*. This implies that *S. armiger* Type I is the new species and Type S with pelagic larvae as the original developmental trait may be the ancestral species. In polychaetes, holobenthic development is generally considered as derived (Schroeder and Hermans 1975; Olive 1985). There are indications that an ancestral *S. armiger* was predisposed to evolve developmental and fertilization modes coupled, i.e. egg cocoons may not be regarded as a *de novo* origin in *S. armiger*. It has been widely recognized that both reproductive traits (developmental and fertilization modes) are correlated in marine invertebrates (e.g. Franzén 1977; Jägersten 1972). Many authors have proposed that co-evolution of egg-envelope and sperm morphology occurs in polychaetes (Jamieson 1983; Franzén 1983; Olive 1983). In molluscs, nucleus lengths of sperm heads may be correlated with egg size (Franzén 1983). Since eggs generally become larger due to higher yolk content with direct development (Olive 1985; Bhaud and Duchêne 1996), an ancestral *S. armiger* with pelagic, lecithotrophic larvae appears to be preadapted to switch to benthic development. Newell (1951) and Thorson (1950) mention thresholds of 160 μm and 150 μm as egg size above which benthic larvae develop, even though there are numerous exceptions to this rule (Giangrande 1997). The egg sizes of *S. armiger* are far above this threshold: Type S develops eggs of 230 μm size (Sveshnikov 1960), those of *S. armiger* Type I are only slightly larger (250 μm) (Anderson 1959).

High variability in developmental mode within the family Orbiniidae suggests a preadaptation for benthic development also on a higher taxonomic level: four of nine species develop egg cocoons and five are free spawning, egg sizes for all nine species are above 150 μm (Giangrande 1997). Within polychaetes egg cocoon formation is present in 46 out of 338 species in total (Giangrande 1997), suggesting that parallel evolution has occurred within this taxon. Parallel evolution refers to independent developmental modification of the same kind (Futuyma 1986). If related species have similar patterns of development, they are likely to be modified in similar ways if subjected to similar selection pressures. In such cases there is no clear distinction between genetic and environmental disruptions of development. In view of

a correlation of sperm morphology with fertilization and developmental modes (Jamieson and Rouse 1989) it appears possible that the trait of egg cocoon formation is linked with reproductive traits. In this case emergence of the egg cocoon in *S. armiger* may be coupled with instantaneous reproductive isolation, i.e. a phenotypic plastic emergence of the egg cocoon may be phylogenetically constrained. In a subsequent step the phenotype of egg cocoon formation then may be fixed in a population by selection. According to a phenomenon described by Waddington (1953), genetic assimilation of phenotypes is possible when specimens are selected for expression of this phenotype.

A stepwise evolution from pelagic larvae to benthic larvae via pelagic lecithotrophic larvae hatching from egg cocoons may also have been possible. No such intermediate form is known for *Scoloplos armiger*, but is present in three orbinid species (Blake 1980). One of them, *Leitoscoloplos pugettensis*, has been found with cocoons producing either benthopelagic 3- 9-setiger larvae or 10- to 12- setiger benthic juveniles within one population. Egg jelly properties have been suggested to be responsible for whether the larvae escape from the cocoon before or after the metamorphosis (Anderson 1959). The jelly of freshly spawned *S. armiger* larvae is highly viscous at first but becomes quite fluid or watery at the time of hatching. This change in viscosity may be due to the presence of several types of protozoans (mostly ciliates) which multiply inside of egg cocoons (Gibbs 1968) but may be caused as well by hatching enzymes secreted by larvae as assumed for *Leitoscoloplos pugettensis* by (Blake 1980). Diffusible chemical compounds within the egg mass jelly are proposed to induce intra-cocoon metamorphosis in an opisthobranch species (Gibson and Chia 1989). A review of egg cocoon occurrence with respect to tidal zone also suggests that a stepwise evolution of this trait may occur easily by parallel evolution. From 46 egg cocoon spawning polychaete species for which Giangrande (1997) mentions a tidal zone, 8 occur in the intertidal and 17 in the infralittoral habitat, which includes the transition zone between the intertidal and the subtidal habitat.

Egg cocoons and physiological tolerance in the context of life-history traits

Immigration of the intertidal with its harsh conditions appears to have required severe and costly adaptations from *S. armiger*. Locally high intertidal abundances (Table 5.1), however, indicate that adaptations have paid. High food resources in this depositional

habitat (de Wilde and Beukema 1984) may represent one good compensation for *S. armiger* as a deposit feeder.

Table 5.1 Comparison of intertidal and subtidal abundances of *S. armiger*

<u>intertidal</u>			<u>subtidal</u>		
area	abundance (ind. * m ⁻²)	Ref.	area	abundance (ind. * m ⁻²)	Ref.
Balgzand 1980s	100	Beukema 1991	Western Dutch Wadden Sea	103	Dekker 1989
Norderney, intertidal sand flat	820	Dörjes et al. 1986	Norderney, sandy subtidal	80	Dörjes et al. 1986
Sylt, intertidal sand flats	302-723	Reise et al. 1994	Sylt-Rømø-Bight, 270 stations	14-18	Armonies, unpubl. data

Similar egg sizes in *S. armiger* Type I and Type S suggest similar energy expenditure for yolk supply of pelagic and benthic larvae. Production of a cocoon, however, seems to be costly (Stickle 1973), which suggests that development in egg cocoons must have substantial survival value. Broadcasting spawners usually compensate higher risks of mortality or fertilization failure by higher numbers of smaller eggs and more sperms. A large number of small eggs or a small number of large eggs can be produced by the same maternal investment (Vance 1973). For *S. armiger* the existence of this trade-off is not clear. No systematic comparison of *S. armiger* Type I and Type S in egg number and female size exists, but apparently, subtidal specimens do not seem to be larger than intertidal ones (own observations). Hence, by producing similar egg sizes, egg numbers of *S. armiger* Type S may not be considerably higher than in Type I. Smaller sperm heads, however, may imply that Type S produces higher sperm numbers than Type I.

Environmental constraints as ultimate causes for the origin of egg cocoons

Different environmental constraints may have invoked the emergence of egg cocoons as an adaptive response. One view is, that protection of the early juvenile stages against eroding wave exposure and extreme temperatures with danger of desiccation during low tide may be an ultimate causation for the emergence of egg cocoons. According to another view, the constraints of dispersal may have been the ultimate factor for egg cocoon development (Bhaud and Duchêne 1996). A shift to development from egg cocoons reduces larval dispersal in *S. armiger* (Chapman

1965; Gibbs 1968). Holding juveniles in environments either characterized by very restricted areas or by very peculiar ecological features may be a prerequisite for the maintenance of populations. The intertidal of the Wadden Sea represents such an environment but any other region with strong and only offshore currents or very heavy larval mortality may exhibit the same constraints. The loss of a pelagic larval stage with metamorphosis into the adult habitat is especially advantageous when resources are high in this habitat. This situation may be indicated by high intertidal abundances of *S. armiger* (see above). In that the subtidal adult habitat may not meet the needs of juveniles, disruptive selection on developmental mode may be implied. However, environmental constraints may be interrelated and thus the ultimate causation or emergence of the egg cocoons may lie in a most opportunistic tradeoff between selective pressures. For example, physiological adaptation to hypoxia and sulphide may have been an ultimate prerequisite for the evolution of egg cocoons additional to the above mentioned constraints. Invasion of the sediment through the several cm long egg cocoon stalk already may require tolerance to hypoxia and sulphide. Pelagic larvae might not exhibit this tolerance if they only settle in the upper mm of the sediment.

Speciation model for *Scoloplos armiger*

If the different possibilities of the emergence of reproductive isolation outlined above are placed into a habitat-related context, two speciation scenarios may arise. The first one refers to an allopatric (geographic) speciation model (Mayr 1963), the other one to sympatric speciation (e.g. Bush 1975; Via 2001). If the allopatric scenario has taken place, the current situation of *S. armiger* Type I and Type S occurring in sympatry in the North Sea must have emerged secondarily while the sympatric scenario may have occurred everywhere in the North East Atlantic where tidal flats with egg cocoons occur. The allopatric speciation model rejects emergence of reproductive isolation in the presence of gene flow, while sympatric speciation is considered to be possible if selection is strong enough and/ or if gene flow between subpopulations is not too high (Via 2001). Accordingly, both scenarios differ in the sequence in which the steps of the speciation process follow each other. The allopatric scenario always involves two steps in speciation. In the first step, genetic differences between populations accumulate in geographic isolation as a random by-product of adaptation to alternative selection regimes and/ or genetic drift and produce reproductive isolation. In the second step a secondary contact of genetically incompatible new species is achieved,

which experience further adaptation to alternative niches. In contrast, following the sympatric scenario divergent or disruptive selection promotes divergence in an adaptive trait that has additional effects on reproductive isolation in one step. Reinforcing mechanisms then complete the speciation.

Allopatric scenarios

Scenario 1: Physiological adaptation as ultimate divergence (Fig. 5.3, 1a)

Step 1: In some coastal part of the distributional range of *Scoloplos armiger* (e.g. the Baltic Sea) strong selective pressure drove the evolution of anaerobic metabolism and sulphide detoxification. This area became geographically isolated leading to a species split up from the ancestral *S. armiger*, keeping pelagic larvae.

Step 2: Pelagic larvae were able to invade the intertidal of the Wadden Sea as a novel habitat since they are preadapted to it in their physiological tolerance. Egg cocoons then have emerged as a secondary trait in the intertidal representing an adaptation to constraints of dispersal in this area or as the only way to colonize shifting intertidal sands.

Scenario 2: Egg cocoons as ultimate divergence (Fig. 5.3, 1b)

Step 1: In some coastal part of the distributional range of *Scoloplos armiger* strong selective pressure occurred against pelagic larvae, i.e., in a region with strong and only offshore currents or very heavy larval mortality (predation, high annual variation in suitable water masses etc.). Under these circumstances the direct mode of development in egg cocoons gradually evolved via (1) shortened free larval life by early stages in cocoons and (2) complete larval development in egg cocoons and gradual loss of characters typical of free-swimming larvae. Such a development must have occurred at some margin of the distributional range where there was no import possible of larvae from outside.

Step 2: *S. armiger* with advanced direct development turned out to be pre-adapted to evolve specific tolerances required for survival in the intertidal zone. Thus, *S. armiger* with direct development spread along the European coasts and occupied the previously not well colonized or even empty intertidal zone.

Sympatric scenario

Scenario: Egg cocoons als ultimate divergence (Fig. 5.3, 2)

Pelagic larvae of *S. armiger* Type S avoided to settle in the intertidal or had no chance to settle there since they experienced habitat-specific strong selective pressure. The intertidal as a marginal habitat was thus invaded by subtidal adults. Those specimens which had the phenotypically plastic ability to develop egg cocoons were able to keep their genes in the intertidal or in the transition zone, all others were broadcasted away with pelagic larvae in the next generation. A stepwise invasion and adaptation to anoxic and sulphidic intertidal conditions followed and appears possible, since the transition between intertidal and subtidal habitat is continuous. Egg cocoons represented a trait with intrinsic barriers to gene flow to the subtidal population, either by phylogenetically constrained linkage to barriers in mating behaviour and gamete incompatibility, or by co-evolution between sexes. Continual retention of larvae and assortative mating within the intertidal habitat additionally restricted gene flow to the subtidal habitat, preventing loss of the newly acquired characters of egg cocoon development and physiological adaptation. In turn did the environmentally induced dying off of pelagic larvae reaching the intertidal or avoidance of the intertidal and poor adaptation of adults to hypoxia and sulphide prevent to blur the gene pool of the intertidal population. Complete reproductive isolation emerged as a result of disruptive selection and reinforcing mechanisms.

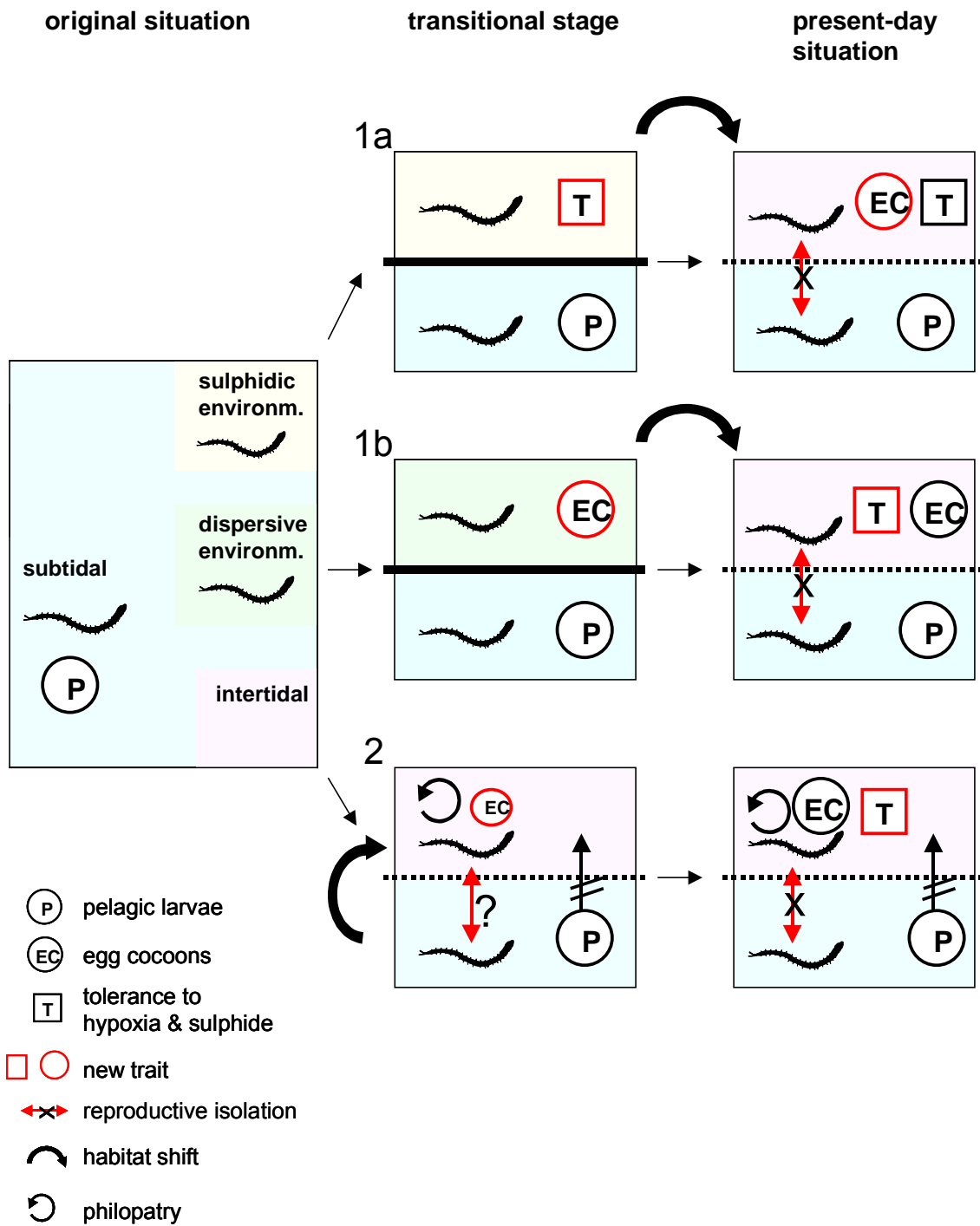

Fig. 5.3 Speciation scenarios for *Scoloplos armiger* according to allopatric (1a and 1b) and sympatric (2) model

Outlook

Final decision for one scenario needs further investigation. Usage of mitochondrial DNA as a molecular clock may help to decide if the allopatric or the sympatric scenario is the most likely. Since allopatric speciation requires biogeographic barriers for pelagic *S. armiger* larvae, dating of the species split might reveal a correlation with geological events (e.g. glaciation). Allopatric speciation requires also more time than sympatric speciation (Bush 1975; McCune and Lovejoy 1998) so that a species split of *S. armiger* dated to much less than one million years ago would support sympatric speciation.

Behavioural divergence of *S. armiger* Type I and Type S in fertilization is an open question. An answer may reveal the ultimate trait responsible for reproductive isolation during speciation. Another question is whether *S. armiger* Type I and Type S are the closest relatives which appears to be most likely due to the high morphological similarity of both types. However, genetic analysis of relatedness should test whether Blake's assumption that *S. armiger* Type I is more closely related to *Leitoscoloplos pugettensis* than to *S. armiger* Type S, and that *S. armiger* Type S is more closely related to *S. acmeceps* than to *S. armiger* Type I is correct. In case Type I and Type S are the closest relatives, the next question would be if the two species are a monophyletic or a paraphyletic group.

In case sympatric speciation has occurred, the possibility exists that this happened repeatedly, i.e. in parallel speciation between intertidal and subtidal habitats within the Eastern North Atlantic. Parallel speciation could be revealed by a phylogenetic test as proposed by Schluter and Nagel (1995) and Orr and Smith (1998). It is present in *S. armiger* when genetic similarity between subtidal and intertidal *S. armiger* of one locality is higher than those comparing the intertidal of this locality with a distant intertidal site. For this comparison intertidal localities should be chosen as distant from another that gene flow, i.e. migration of benthic larvae or adults between them, may be regarded as impossible (e.g. the island of Sylt and the Isle of Man, Irish Sea).

Outlook to speciation processes in the marine environment

One question of broader relevance emerging from speciation of *S. armiger* is, whether the lower tide line suffices as a dividing barrier for a speciation process. More findings of closely related species in adjacent tidal zones would provide support for this

hypothesis. Listings of numerous sympatric sibling species of marine invertebrates found to exhibit distinct habitat preferences defined by water depth (Knowlton 1993) indicate that such species may exist.

Another crucial question arising from the current study is how the emergence of the egg cocoon and direct development may accelerate speciation in marine invertebrates. In case developmental modes evolve in linkage with fertilization modes (gamete morphology and mating behaviour), an evolutionary two-in-one mechanism facilitating speciation would exist. Combined with habitat-shift and alteration of the dispersal potential with developmental mode, this would provide a pendant to habitat or host-shifts favouring sympatric speciation as found in insects, e.g. in the apple maggot fly *Rhagoletis*, the classic example of sympatric speciation (Bush 1975; Diehl and Bush 1989). Sympatric speciation in marine invertebrates is assumed by several authors (Knowlton 1993; Gosling 1994; Palumbi 1994) in view of a high number of phenotypically similar, recently diverged species with low genetic divergence. Yet, not a single, valid example of sympatric speciation in marine invertebrates appears to be documented to date.

References

- Anderson DT (1959) The embryology of the polychaete *Scoloplos armiger*. Q J microsc Sci 100:69-166
- Armonies W (1994) Drifting meio- and macrobenthic invertebrates on tidal flats in Königshafen: a review. Helgol Meeresunters 48:299-320
- Beukema JJ (1991) Changes in composition of bottom fauna of a tidal-flat area during a period of eutrophication. Mar Biol 111:293-301
- Bhaud M, Duchêne J-C (1996) Change from planktonic to benthic development: is life cycle evolution an adaptive answer to the constraints of dispersal? Oceanol Acta 19:335-346
- Blake JA (1980) The larval development of Polychaeta from the northern California coast IV. *Leitoscoloplos pugettensis* and *Scoloplos acmeceps* (Family Orbiniidae). Ophelia 19:1-18
- Burton RS, Feldman MW (1982) Population genetics of coastal and estuarine invertebrates: does larval behaviour influence population structure? In: Kennedy VS (ed) Estuarine Comparisons. Academic Press, New York, pp 537-551
- Bush GL (1975) Modes of animal speciation. Ann Rev Ecol Syst 6:339-364

- Butman CA (1989) Sediment-trap experiments on the importance of hydrodynamical processes in distributing settling invertebrate larvae in near-bottom waters. *J Exp Mar Biol Ecol* 134:37-88
- Chapman G (1965) The egg cocoons of *Scoloplos armiger* O. F. Müller. *Biol Bull (Woods Hole)* 128:189-197
- de Wilde P and Beukema JJ (1984) The role of the zoobenthos in the consumption of organic matter in the Dutch Wadden Sea. *Publ Ser Neth Inst Sea Res* 10:145-158
- Dekker R (1989) The macrobenthos of the subtidal Western Dutch Wadden Sea, I. Biomass and species richness. *Neth J Sea Res* 23:57-68
- Diehl SR, Bush GL (1989) The role of habitat preference in adaptation and speciation. In: Otte D, Endler JA (eds) *Speciation and its consequences*. pp 345-365
- Dörjes J, Michaelis H, Rhode B (1986) Long-term studies of macrozoobenthos in intertidal and shallow subtidal habitats near the island of Norderney (East Frisian coast, Germany). *Hydrobiologia* 142:217-232
- Franzén Å (1977) Sperm structure with regard to fertilization biology and phylogenetics. *Ver Dtsch Zool Ges* 70:123-138
- Franzén Å (1983) Ultrastructural studies on spermatozoa in three bivalve species with notes on evolution of elongated sperm nucleus in primitive spermatozoa. *Gamete Res* 7:199-214
- Futuyma DJ (1986) *Evolutionary Biology*. Sinauer Ass., Sunderland, Massachusetts
- Gätje C, Reise K (1998) *Ökosystem Wattenmeer, Austausch-, Transport- und Stoffumwandlungsprozesse*. Springer, Berlin
- Giangrande A (1997) Polychaete reproductive patterns, life cycles and life histories: an overview. *Oceanogr Mar Biol Annu Rev* 35:323-386
- Gibbs PE (1968) Observations on the population of *Scoloplos armiger* at Whitstable. *J mar biol Ass UK* 48:225-254
- Gibson GD, Chia FS (1989) Developmental variability (benthic and pelagic) in *Haminoea callidegenita* (Opisthobranchia: Cephalaspidea) is influenced by egg mass jelly. *Biol Bull (Woods Hole)* 176:103-110
- Gosling EM (1994) Speciation and species concepts in the marine environment. In: Beaumont AR (ed) *Genetics and evolution of aquatic organisms*. Chapman & Hall, London
- Jägersten G (1972) *Evolution of the Metazoan life cycle*. Academic Press, London
- Jamieson BGM (1983) Spermiogenesis in the oligochaetoid polychaete *Questa* (Annelidae, Questidae). *Zool Scr* 12:179-186
- Jamieson BGM, Rouse GW (1989) The spermatozoa of the Polychaeta (Annelida): an ultrastructural review. *Biol Rev* 64:93-157

- Johannesson K (2001) Parallel speciation: a key to sympatric speciation. *Trends Ecol Evol* 16:148-153
- Knight-Jones EW (1953) Decreased discrimination during settling after prolonged planktonic life in larvae of *Spirorbis borealis* (Serpulidae). *J mar biol Ass UK* 32:337-345
- Knowlton N (1993) Sibling species in the sea. *Annu Rev Ecol Syst* 24:89-216
- Mayr E (1963) *Animal species and evolution*. Harvard University Press, Cambridge
- McCune AR, Lovejoy NR (1998) The relative rate of sympatric and allopatric speciation in fishes. In: Howard DJ, Berlocher SH (eds) *Endless forms: Species and Speciation*. Oxford University press, pp 172-185
- Newell GE (1951) The life history of *Clymenella torquata* (Maldanidae). *Proc Zool Soc Lond* 21:561
- Olive PJ (1983) Annelida - Polychaeta. In: Adiyodi KG, Adiyodi RG (eds) *Spermatogenesis and sperm function*. John Wiley, Chichester
- Olive PJW (1985) Covariability of reproductive traits in marine invertebrates: implications for the phylogeny of the lower invertebrates. *The origins and relationships of lower invertebrates*. Oxford University Press, Oxford, pp 42-59
- Orr MR, Smith TB (1998) Ecology and speciation. *Trends Ecol Evol* 13:502-506
- Palumbi SR (1994) Genetic divergence, reproductive isolation, and marine speciation. *Ann Rev Ecol Syst* 25:547-572
- Reise K (1979) Spatial configurations generated by motile benthic polychaetes. *Helgol Meeresunters* 32:55-72
- Reise K, Herre E, Sturm M (1994) Biomass and abundance of macrofauna in intertidal sediments of Königshafen in the northern Wadden Sea. *Helgol Meeresunters* 48:201-215
- Sach G (1975) Zur Fortpflanzung des Polychaeten *Anaitides mucosa*. *Mar Biol* 31:157-160
- Schluter D, Nagel LM (1995) Parallel speciation by natural selection. *Am Nat* 146:292-301
- Schroeder PC, Hermans CO (1975) *Annelida: Polychaeta*. Academic Press Inc., New York, San Francisco, London
- Speciation Glossary (2001) *Trends Ecol Evol* 16:412-413
- Stickle WB (1973) The reproductive physiology of the intertidal prosobranch *Thais lamellosa* (Gmelin). Seasonal changes in the rate of oxygen consumption and body component indices. *Biol Bull (Woods Hole)* 144:511-524

-
- Sveshnikov VA (1960) Pelagic larvae of some polychaeta in the White Sea. Zool Zh 39:343-355
- Thorson G (1950) Reproductive and larval ecology of marine bottom invertebrates. Biol Rev 25:1-45
- Vance R (1973) On reproductive strategies of marine invertebrates. Am Nat 107:339-352
- Via S (2001) Sympatric speciation in animals: the ugly duckling grows up. Trends Ecol Evol 16:381-390
- Waddington CH (1953) Genetic assimilation of an acquired character. Evolution 7:118-126
- Weber K (1992) Fortpflanzung, Populationsdynamik und Lebensweise von *Scoloplos armiger*. Diploma Thesis, Christian-Albrechts-Universität Kiel. pp. 1-69
- Woodin SA (1986) Settlement of Infauna: Larval Choice? Bull Mar Sci. 39:401-407
- Zühlke R, Reise K (1994) Response of macrofauna to drifting tidal sediments. Helgol Meeresunters 48:277-289

Danksagung

Danken möchte ich allen voran Karsten Reise, für seine Betreuung und Unterstützung, und sein Vertrauen. Martin Wahl danke ich für die Übernahme der Korreferenz meiner Dissertation, Sievert Lorenzen für die augenöffnenden Diskussionen. Bei allen Mitarbeiterinnen und Mitarbeitern der Wattenmeerstation Sylt des Alfred-Wegener-Instituts möchte ich mich für das tolle Miteinander bedanken. Lilo Herre, Gurdy Bardt und Kristin Kessenich habe ich unzählige Male aufgesucht, um mit vollen Händen oder mit Lösungsmöglichkeiten zu allerlei Problemen in mein Labor zurückzukehren. Peter Martens half mir immer wieder in Computerangelegenheiten. Die elektronenmikroskopische Welt durfte ich mit Hanne Halliger entdecken. Bei Werner Armonies fand ich in wissenschaftlichen Fragen immer ein offenes Ohr und den allerbesten Rat. Matthias Strasser danke ich für alle Anregungen und die gute Projektzeit, Petra Kadel für ihre Freundschaft samt Buchteln. In Laborgemeinschaft mit Susanne Diederich habe ich mich sehr wohl gefühlt.

Die Crew der "Mya", Niels Kruse und Peter Elvert, ermöglichten mir mit ihrem vollen und sachkundigen Einsatz das Beprobieren des Sublitorals, auf unersättlicher Suche nach der begehrten Himbeermarmelade. Zum Schluss, auf Männerfang, war auch Timo Wieck dabei. Großer Dank geht an alle, die dafür sorgten, dass sich die vollen Eimer auf der Mya nicht stauten, die mir beim Buddeln und Schleppen im Watt halfen und mehr als sieben mal siebten. Neben vielen anderen waren dies Nils Volkenborn, Tina Löbl, Tanja Peter und Katja Heise.

In die Populationsgenetik führten mich Thorsten Reusch, Vicky Schneider und Sieglinde Bahns ein. Reimert Neuhaus unterstützte mich in der ersten Zeit. Carsten Pape, Tina Löbl und Fabienne Goulard halfen mir grandios in den letzten Tagen beim Layout und Ausdrucken, Martin Thiel im Diskussions-Endspurt. Meine Eltern und all meine Geschwister wusste ich immer hinter mir. Patric Polte möchte ich dafür um Entschuldigung bitten, dass ich seinen Namen jetzt immer falsch schreiben werde, nach all den angestellten Vermutungen über "allopatric and sympatric scenarios".

Mein sehr gut ausgestatteter Arbeitsplatz wurde mir anfangs von der BAH, später vom AWI zur Verfügung gestellt. Finanziell wurde ich vom Bundesministerium für Bildung und Forschung (BMBF) unter der Projekt-Nr. 03F0179A, und vom AWI unterstützt.

Mein ganz besonderer Dank geht an meine Mitbewohner des Hauses Donau, die für ein einmaliges Zusammengehörigkeitsgefühl sorgten. Ohne sie wäre alles nichts gewesen, viel echte Freundschaft konnte wachsen.